



Maintenance and Service Guide

SUMMARY

This guide provides information about spare parts, removal and replacement of parts, security, backing up, and more.

© Copyright 2021 HP Development Company, L.P.

AMD, Radeon, and Ryzen are trademarks of Advanced Micro Devices, Inc. Bluetooth is a trademark owned by its proprietor and used by HP Inc. under license. SDHC, SDXC, and microSD are trademarks or registered trademarks of SD-3C LLC. Microsoft and Windows are either registered trademarks or trademarks of Microsoft Corporation in the United States and/or other countries. USB Type-C and USB-C are registered trademarks of USB Implementers Forum. DisplayPort™ and the DisplayPort™ logo are trademarks owned by the Video Electronics Standards Association (VESA®) in the United States and other countries. Miracast is a registered trademark of Wi-Fi Alliance.

The information contained herein is subject to change without notice. The only warranties for HP products and services are set forth in the express warranty statements accompanying such products and services. Nothing herein should be construed as constituting an additional warranty. HP shall not be liable for technical or editorial errors or omissions contained herein.

First Edition: May 2021

Document Part Number: M44536-001

Product notice

This guide describes features that are common to most models. Some features may not be available on your computer.

Not all features are available in all editions or versions of Windows. Systems may require upgraded and/or separately purchased hardware, drivers, software or BIOS update to take full advantage of Windows functionality. Windows 10 is automatically updated, which is always enabled. ISP fees may apply and additional requirements may apply over time for updates. Go to <http://www.microsoft.com> for details.

To access the latest user guides, go to <http://www.hp.com/support>, and follow the instructions to find your product. Then select **Manuals**.

Software terms

By installing, copying, downloading, or otherwise using any software product preinstalled on this computer, you agree to be bound by the terms of the HP End User License Agreement (EULA). If you do not accept these license terms, your sole remedy is to return the entire unused product (hardware and software) within 14 days for a full refund subject to the refund policy of your seller.

For any further information or to request a full refund of the price of the computer, please contact your seller.

Safety warning notice

Reduce the possibility of heat-related injuries or of overheating the computer by following the practices described.

-
-  **WARNING!** To reduce the possibility of heat-related injuries or of overheating the computer, do not place the computer directly on your lap or obstruct the computer air vents. Use the computer only on a hard, flat surface. Do not allow another hard surface, such as an adjoining optional printer, or a soft surface, such as pillows or rugs or clothing, to block airflow. Also, do not allow the AC adapter to come into contact with the skin or a soft surface, such as pillows or rugs or clothing, during operation. The computer and the AC adapter comply with the user-accessible surface temperature limits defined by applicable safety standards.
-

Table of contents

1 Product description.....	1
2 Getting to know your computer.....	4
Right side.....	4
Left side.....	5
Display.....	6
Low blue light mode (select products only).....	6
Keyboard area.....	7
Touchpad settings and components.....	8
Touchpad settings.....	8
Adjusting touchpad settings.....	8
Turning on the touchpad.....	8
Touchpad components.....	8
Lights.....	9
Button, vent, and fingerprint reader.....	9
Special keys.....	11
Bottom.....	12
Labels.....	13
3 Illustrated parts catalog.....	15
Computer major components.....	15
Display assembly subcomponents.....	17
Cables.....	19
Miscellaneous parts.....	20
4 Removal and replacement procedures preliminary requirements.....	22
Tools required.....	22
Service considerations.....	22
Plastic parts.....	22
Cables and connectors.....	22
Drive handling.....	22
Electrostatic discharge information.....	23
Generating static electricity.....	23
Preventing electrostatic damage to equipment.....	24
Personal grounding methods and equipment.....	24
Grounding the work area.....	25
Recommended materials and equipment.....	25
Cleaning your computer.....	26
Enabling HP Easy Clean (select products only).....	26
Removing dirt and debris from your computer.....	26

Cleaning your computer with a disinfectant	27
Caring for wood veneer (select products only)	28
Packaging and transporting guidelines	28
Accessing support information	28
5 Removal and replacement procedures for authorized service provider parts	31
Component replacement procedures.....	31
Preparation for disassembly	31
Bottom cover	31
Battery	33
Solid-state drive	34
Speakers	35
WLAN module	36
Touchpad	38
Fingerprint reader.....	39
Fan	40
Heat sink	41
Light bar.....	42
Audio board.....	43
USB door	44
System board.....	45
Power connector cable	47
Display assembly.....	48
Top cover with keyboard.....	54
6 Using Setup Utility (BIOS)	56
Starting Setup Utility (BIOS)	56
Updating Setup Utility (BIOS)	56
Determining the BIOS version	56
Preparing for a BIOS update	57
Downloading a BIOS update	57
Installing a BIOS update	57
7 Backing up, restoring, and recovering	59
Backing up information and creating recovery media.....	59
Using Windows tools for backing up	59
Using the HP Cloud Recovery Download Tool to create recovery media (select products only).....	59
Restoring and recovering your system	59
Creating a system restore	60
Restoring and recovery methods	60
Recovering using HP Recovery media	60
Changing the computer boot order	61
Using HP Sure Recover (select products only)	61
8 Using HP PC Hardware Diagnostics	62
Using HP PC Hardware Diagnostics Windows (select products only)	62
Using an HP PC Hardware Diagnostics Windows hardware failure ID code	62
Accessing HP PC Hardware Diagnostics Windows.....	62

Accessing HP PC Hardware Diagnostics Windows from HP Help and Support (select products only).....	62
Accessing HP PC Hardware Diagnostics Windows from Support Assistant.....	63
Accessing HP PC Hardware Diagnostics Windows from the Start menu (select products only)	63
Downloading HP PC Hardware Diagnostics Windows	63
Downloading the latest HP PC Hardware Diagnostics Windows version from HP	63
Downloading the HP PC Hardware Diagnostics Windows from the Microsoft Store.....	63
Downloading HP Hardware Diagnostics Windows by product name or number (select products only)	64
Installing HP PC Hardware Diagnostics Windows	64
Using HP PC Hardware Diagnostics UEFI	64
Using an HP PC Hardware Diagnostics UEFI hardware failure ID code	64
Starting HP PC Hardware Diagnostics UEFI.....	65
Downloading HP PC Hardware Diagnostics UEFI to a USB flash drive	65
Downloading the latest HP PC Hardware Diagnostics UEFI version	65
Downloading HP PC Hardware Diagnostics UEFI by product name or number (select products only).....	65
Using Remote HP PC Hardware Diagnostics UEFI settings (select products only)	66
Downloading Remote HP PC Hardware Diagnostics UEFI	66
Downloading the latest Remote HP PC Hardware Diagnostics UEFI version	66
Downloading Remote HP PC Hardware Diagnostics UEFI by product name or number	66
Customizing Remote HP PC Hardware Diagnostics UEFI settings	66
9 Specifications	68
Computer specifications	68
33.8 cm (13.3 in) display specifications	68
Solid-state drive specifications	69
10 Power cord set requirements	70
Requirements for all countries.....	70
Requirements for specific countries and regions	70
11 Recycling	72
Index	73

1 Product description

This table provides detailed product information.

Table 1-1 Product components and their descriptions

Category	Description
Product Name	HP Pavilion Aero 13 Laptop PC Model numbers: 13-be0xxx CTO model: 13z-be000
Processors	AMD® processors AMD Ryzen™ 7 5800U with Radeon™ HD Graphics (1.90 GHz base frequency, up to 4.40 GHz, 16 MB L3 cache, 8 cores, 15 W) AMD Ryzen 5 5600U with Radeon HD Graphics (2.30 GHz base frequency, up to 4.20 GHz, 16 MB L3 cache, 6 cores, 15 W)
Graphics	Internal graphics AMD Radeon Graphics
Display	13.3 in (33.8 cm), ultrawide viewing angle (UWVA), antiglare, 100% sRGB, eDP 1.4 + PSR2, flat, 400 nits WQXGA (2560 × 1600) WUXGA (1920 × 1200)
Memory	Memory not customer accessible or upgradeable DDR4-3200, 1.2 V Supports the following configurations: <ul style="list-style-type: none">• 16 GB• 8 GB
Primary storage	PCIe, NVMe, M.2 2280 solid-state drives 1 TB 512 GB 256 GB

Table 1-1 Product components and their descriptions (continued)

Category	Description
Audio and video	B&O PLAY HD Audio
	Dual speakers
	Support for HP Audio Boost
	Supports Alexa
	Supports Cortana (far field)
	Supports XiaoWei
	HP Wide Vision HD Camera: indicator LED, USB 2.0, HD BSI sensor, f2.0, WDR, 88° WFOV
	720p by 30 frames per second
Dual-array digital microphone with appropriate software: beam forming, echo cancellation, noise suppression	
Wireless	Compatible with Miracast® devices
	Supports Modern Standby (Connected)
	Wi-Fi BIOS SAR (Specific Absorption Rate)
	Turbo Lite Wireless Local Area Network (WLAN) Symbol Virtual Terminal Program (SVTP)
	Integrated wireless options with dual antennas
	Realtek Wi-Fi 6 RTL8852AE + Bluetooth® 5.2 (802.11ax 2 × 2, multiuser, multiple input, multiple output (MU-MIMO) supported, supporting gigabit file transfer speeds)
	Realtek Wi-Fi 6 RTL8852AE-VT + Bluetooth 5.2 (802.11ax 1 × 2, MU-MIMO supported, supporting gigabit file transfer speeds)
	Integrated wireless options with single antenna
Realtek RTL8821CE 802.11b/g/n/a/ac (1 × 1) MU-MIMO supported and Bluetooth 4.2 combo	
Ports	HDMI v2.0 + HDCP 2.2 supporting: up to 4096 × 2160 @ 60 Hz
	Audio-out (headphone)/audio-in (microphone) combo jack
	USB 3.2 Gen 2 Type-C (supports data transfer, Power Delivery 3.0, HP Sleep & Charge; DisplayPort™ 1.4 out up to 5120 × 2880 @ 60 Hz through adapter; HDMI 2.0 out up to 4096 × 2160 @ 60 Hz with HDCP 2.2 through adapter)
	USB 3.2 Gen 1 Type-A (2)
	AC Smart Pin adapter plug
Keyboard/pointing devices	Keyboard
	Full size in the following colors: natural silver, warm gold, ceramic white, pale rose gold
	Backlit, island style in the following colors: natural silver, warm gold, ceramic white, pale rose gold
	Clickpad
	Image sensor
	Multitouch gestures enabled
	Precision touchpad support
	Support for Modern Trackpad Gestures
Taps enabled as default	

Table 1-1 Product components and their descriptions (continued)

Category	Description
Power requirements	Battery
	3 cell, 43 Whr, lithium-polymer
	HP long life
	HP Fast Charge Technology
	Smart AC adapters (barrel type, 4.5 mm)
	65 W
	65 W, EM
	45 W
	Power cord
	C5, 1 m (3.3 ft)
Security	Supports Trusted Platform Module (fTPM) 2.0, firmware based
	Integrated fingerprint reader (select products only)
Operating system	Windows® 10 Home 64
	Windows 10 Home 64 Chinese Market CPPP
	Windows 10 Home 64 High-end Chinese Market CPPP
	Windows 10 Home 64 Plus
	Windows 10 Home 64 Plus Single Language
	Windows 10 Home 64 Plus Single Language Africa Market
	Windows 10 Home 64 Plus Single Language APAC EM PPP
	Windows 10 Home 64 Plus Single Language India Market
	Windows 10 Home 64 Plus Single Language Indonesia Market
	Windows 10 Home 64 Single Language
	Windows 10 Home 64 Single Language Africa Market
	Windows 10 Home 64 Single Language APAC EM PPP
	Windows 10 Home 64 Single Language India Market
	Windows 10 Home 64 Single Language Indonesia Market
	Windows 10 Home S 64
	Windows 10 Home S 64 Plus
	Windows 10 Pro 64
	Windows 10 Pro 64 Chinese Market
	FreeDOS 3.0
	Serviceability
AC adapter	

2 Getting to know your computer

Your computer features top-rated components. This chapter provides details about your components, where they are located, and how they work.

Right side

Identify the components on the right side of the computer.



Table 2-1 Right-side components and their descriptions

Component	Description
(1) SD microSD™ memory card reader	<p>Reads optional memory cards that enable you to store, manage, share, or access information.</p> <p>To insert a card:</p> <ol style="list-style-type: none">1. Hold the card label-side up, with connectors facing the computer.2. Insert the card into the memory card reader, and then press in on the card until it is firmly seated. <p>To remove a card:</p> <ul style="list-style-type: none">■ Press in on the card, and then remove it from the memory card reader.
(2) SS USB SuperSpeed port	<p>Connects a USB device, provides high-speed data transfer, and (for select products) charges small devices (such as a smartphone) when the computer is on or in Sleep mode.</p> <p>NOTE: Use a standard USB Type-A charging cable or cable adapter (purchased separately) when charging a small external device.</p>

Table 2-1 Right-side components and their descriptions (continued)

Component	Description
(3) AC adapter and battery light	<ul style="list-style-type: none">• White: The AC adapter is connected and the battery is fully charged.• Blinking amber: The AC adapter is disconnected and the battery has reached a low battery level.• Amber: The AC adapter is connected and the battery is charging.• Off: The battery is not charging.
(4)  Power connector	Connects an AC adapter.

Left side

Identify the components on the left side of the computer.

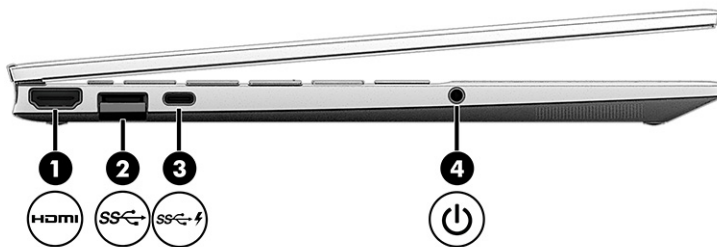

Table 2-2 Left-side components and their descriptions





Component	Description
(1)  HDMI port	Connects an optional video or audio device, such as a high-definition television, any compatible digital or audio component, or a high-speed High-Definition Multimedia Interface (HDMI) device.
(2)  USB SuperSpeed port	Connects a USB device, provides high-speed data transfer, and (for select products) charges small devices (such as a smartphone) when the computer is on or in Sleep mode. NOTE: Use a standard USB Type-A charging cable or cable adapter (purchased separately) when charging a small external device.

Table 2-2 Left-side components and their descriptions (continued)

Component	Description
(3)  USB Type-C® power connector port, SuperSpeed port, and DisplayPort connector	<p>Connects an AC adapter that has a USB Type-C connector, supplying power to the computer and, if needed, charging the computer battery.</p> <p>– and –</p> <p>Connects a USB device, provides high-speed data transfer, and (for select products) charges small devices (such as a smartphone) when the computer is on or in Sleep mode.</p> <p>NOTE: Use a standard USB Type-C charging cable or cable adapter (purchased separately) when charging a small external device.</p> <p>– and –</p> <p>Connects a display device that has a USB Type-C connector, providing DisplayPort output.</p>
(4)  Audio-out (headphone)/Audio-in (microphone) combo jack	<p>Connects optional powered stereo speakers, headphones, earbuds, a headset, or a television audio cable. Also connects an optional headset microphone. This jack does not support optional standalone microphones.</p> <p>WARNING! To reduce the risk of personal injury, adjust the volume before putting on headphones, earbuds, or a headset. For additional safety information, see the <i>Regulatory, Safety, and Environmental Notices</i>.</p> <p>To access this guide:</p> <ul style="list-style-type: none">■ Type HP Documentation in the taskbar search box, and then select HP Documentation. <p>NOTE: When a device is connected to the jack, the computer speakers are disabled.</p>

Display

The computer display can include essential components such as speakers, antennas, cameras, and microphones.

Low blue light mode (select products only)

Your computer display is shipped from the factory in low blue light mode for improved eye comfort and safety. Also, blue light mode automatically adjusts blue light emissions when you are using the computer at night or for reading.

WARNING! To reduce the risk of serious injury, read the *Safety & Comfort Guide*. It describes proper workstation setup and proper posture, health, and work habits for computer users. The *Safety & Comfort Guide* also provides important electrical and mechanical safety information. The *Safety & Comfort Guide* is available on the web at <http://www.hp.com/ergo>.

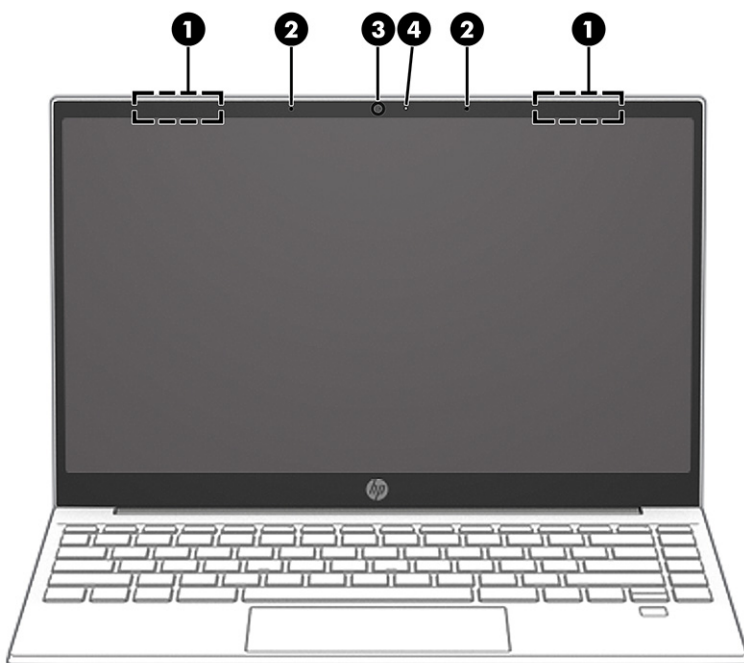

Table 2-3 Display components and their descriptions

Component	Description
(1) WLAN antennas*	Send and receive wireless signals to communicate with wireless local area networks (WLANs).
(2) Internal microphones (2)	Record sound.
(3) Camera	Allows you to video chat, record video, and record still images. Some cameras also allow a facial recognition logon to Windows, instead of a password logon. NOTE: Camera functions vary depending on the camera hardware and software installed on your product.
(4) Camera light	On: The camera is in use.

*The antennas are not visible from the outside of the computer. For optimal transmission, keep the areas immediately around the antennas free from obstructions.

For wireless regulatory notices, see the section of the *Regulatory, Safety, and Environmental Notices* that applies to your country or region.

To access this guide:

- Type `HP Documentation` in the taskbar search box, and then select **HP Documentation**.

Keyboard area

Keyboards can vary by language.

NOTE: The keyboard area, including the function keys and (select products only) power key, is disabled in stand, tent, and tablet modes. To enable the keyboard, including the power key, change to the clamshell mode.

Touchpad settings and components

Learn the touchpad settings and components

Touchpad settings

Learn how to adjust touchpad settings.

Adjusting touchpad settings

Use these steps to adjust touchpad settings and gestures.

1. Type `touchpad settings` in the taskbar search box, and then press [enter](#).
2. Choose a setting.

Turning on the touchpad

Follow these steps to turn on the touchpad.

1. Type `touchpad settings` in the taskbar search box, and then press [enter](#).
2. Using an external mouse, click the **touchpad** button.

If you are not using an external mouse, press the [Tab](#) key repeatedly until the pointer rests on the **touchpad** button. Then press the [spacebar](#) to select the button.

Touchpad components

Identify the touchpad components.

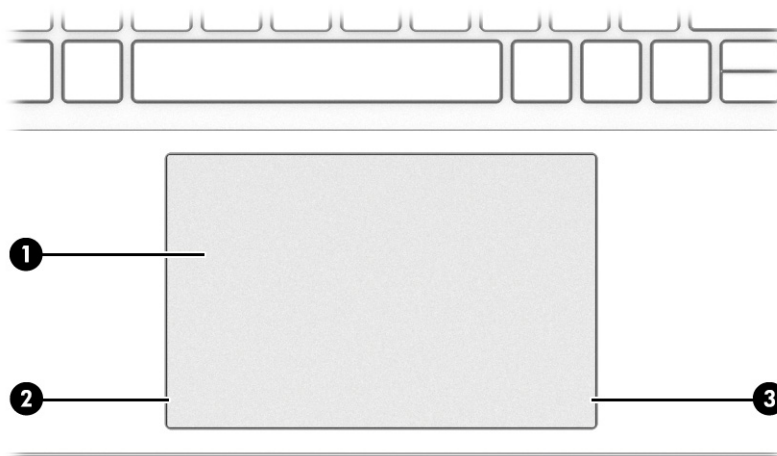

Table 2-4 Touchpad components and their descriptions

Component	Description
(1) Touchpad zone	Reads your finger gestures to move the pointer or activate items on the screen.
(2) Left control zone	Textured area that allows you to perform additional gestures.
(3) Right control zone	Textured area that allows you to perform additional gestures.

Lights

Identify the lights on the computer.

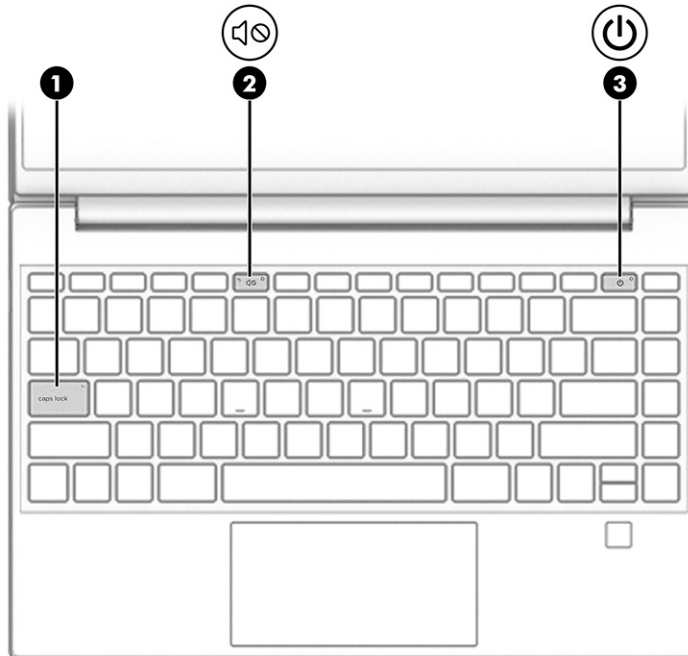

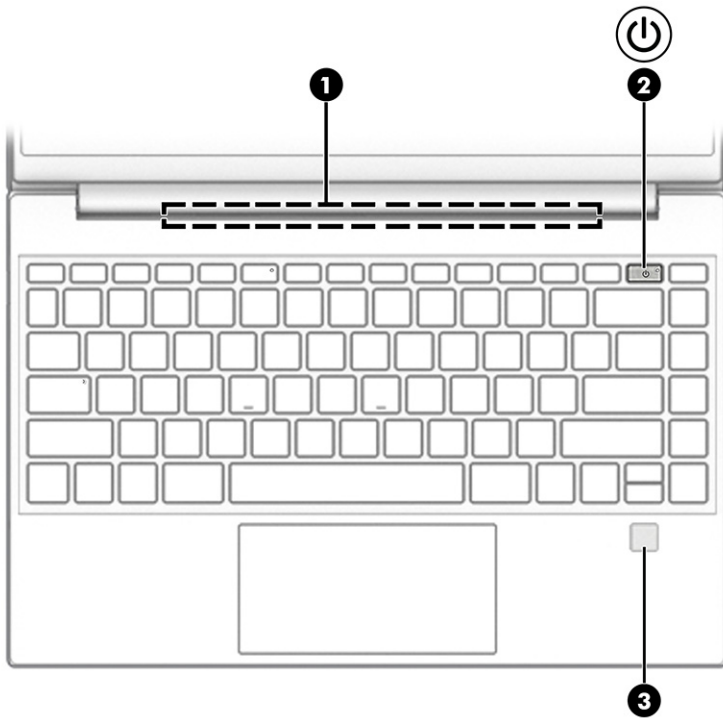

Table 2-5 Lights and their descriptions

Component	Description
(1) Caps lock light	On: Caps lock is on, which switches the key input to all capital letters.
(2)  Mute light	<ul style="list-style-type: none">• On: Computer sound is off.• Off: Computer sound is on.
(3)  Power light	<ul style="list-style-type: none">• On: The computer is on.• Blinking (select products only): The computer is in the Sleep state, a power-saving state. The computer shuts off power to the display and other unnecessary components.• Off: Depending on your computer model, the computer is off, in Hibernation, or in Sleep. Hibernation is the power-saving state that uses the least amount of power.

Button, vent, and fingerprint reader

Identify the computer button, vent and fingerprint reader.





Fingerprint readers, which enable a fingerprint logon, can be located on the touchpad, on a side panel of the computer, or on the top cover below the keyboard.

IMPORTANT: To verify that your computer supports fingerprint reader sign-in, type `Sign-in options` in the taskbar search box and follow the on-screen instructions. If **Fingerprint reader** is not listed as an option, then your computer does not include a fingerprint reader.

Table 2-6 Button, vent, and fingerprint reader and their descriptions

Component	Description
(1) Vent	Enables airflow to cool internal components. NOTE: The computer fan starts up automatically to cool internal components and prevent overheating. It is normal for the internal fan to cycle on and off during routine operation.

Table 2-6 Button, vent, and fingerprint reader and their descriptions (continued)

Component	Description
<p>(2)  Power button</p>	<ul style="list-style-type: none"> • When the computer is off, press the button briefly to turn on the computer. • When the computer is on, press the button briefly to initiate Sleep. • When the computer is in the Sleep state, press the button briefly to exit Sleep (select products only). • When the computer is in Hibernation, press the button briefly to exit Hibernation. <p>IMPORTANT: Pressing and holding down the power button results in the loss of unsaved information.</p> <p>If the computer has stopped responding and shutdown procedures are ineffective, press and hold the power button down for at least 10 seconds to turn off the computer.</p> <p>To learn more about your power settings, see your power options:</p> <ul style="list-style-type: none"> ■ Right-click the Power icon , and then select Power Options.
<p>(3)  Fingerprint reader (select products only)</p>	<p>Allows a fingerprint logon to Windows, instead of a password logon.</p> <ul style="list-style-type: none"> ■ Swipe down across the fingerprint reader. <p>IMPORTANT: To prevent fingerprint logon issues, make sure when you register your fingerprint that all sides of your finger are registered by the fingerprint reader.</p>

Special keys

Identify the special keys.

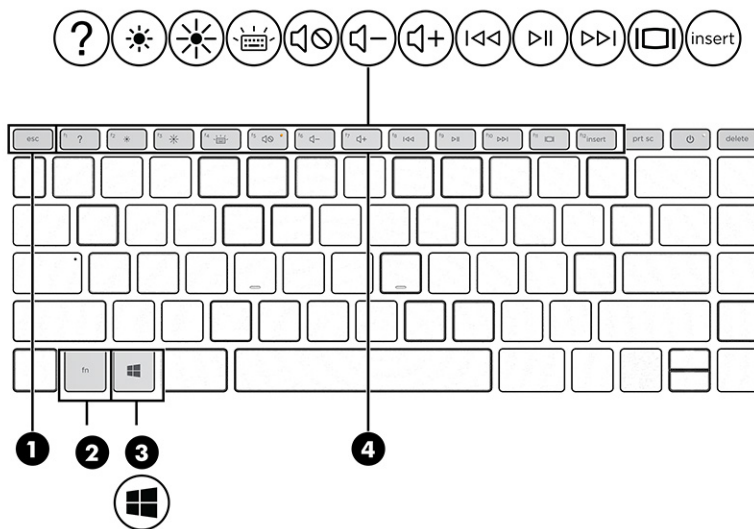



Table 2-7 Special keys and their descriptions

Component	Description
(1) esc key	Displays system information when pressed in combination with the fn key.
(2) fn key	Executes specific functions when pressed in combination with another key.
(3)  Windows key	Opens the Start menu. NOTE: Pressing the Windows key again will close the Start menu.
(4) Action keys	Execute frequently used system functions as defined by the icon symbols on f1 through f12 function keys.

Bottom

Identify the bottom components.

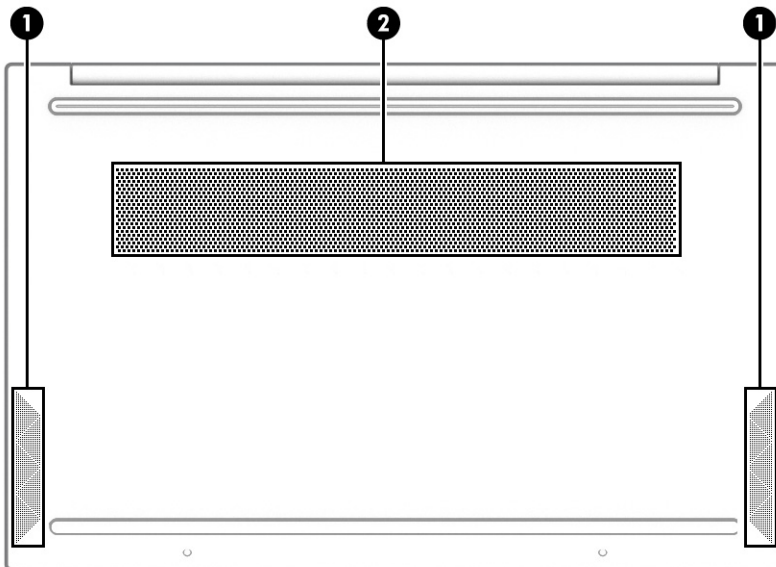

Table 2-8 Bottom components and their descriptions

Component	Description
(1) Speakers (2)	Produce sound.
(2) Vent	Enables airflow to cool internal components. NOTE: The computer fan starts up automatically to cool internal components and prevent overheating. It is normal for the internal fan to cycle on and off during routine operation.

Labels

The labels affixed to the computer provide information that you might need when you troubleshoot system problems or travel internationally with the computer. Labels can be in paper form or imprinted on the product.

IMPORTANT: Check the following locations for the labels described in this section: the bottom of the computer, inside the battery bay, under the service door, on the back of the display, or on the bottom of a tablet kickstand.

- Service label—Provides important information to identify your computer. When contacting support, you might be asked for the serial number, the product number, or the model number. Locate this information before you contact support.

Your service label will resemble one of the following examples. Refer to the illustration that most closely matches the service label on your computer.



Table 2-9 Service label components

Component
(1) Serial number
(2) Product ID
(3) HP product name and model number

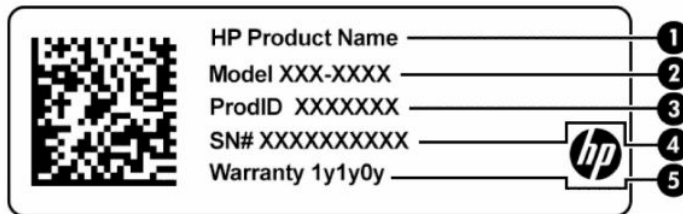

Table 2-10 Service label components

Component
(1) HP product name
(2) Model number
(3) Product ID
(4) Serial number
(5) Warranty period

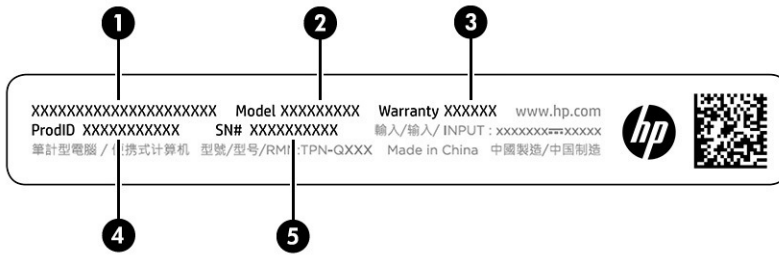

Table 2-11 Service label components

Component	
(1)	HP product name
(2)	Model number
(3)	Warranty period
(4)	Product ID
(5)	Serial number

- Regulatory labels—Provide regulatory information about the computer.
- Wireless certification labels—Provide information about optional wireless devices and the approval markings for the countries or regions in which the devices have been approved for use.

3 Illustrated parts catalog

Use this chapter to determine the spare parts that are available for the computer.

Computer major components

To identify the computer major components, use this illustration and table.

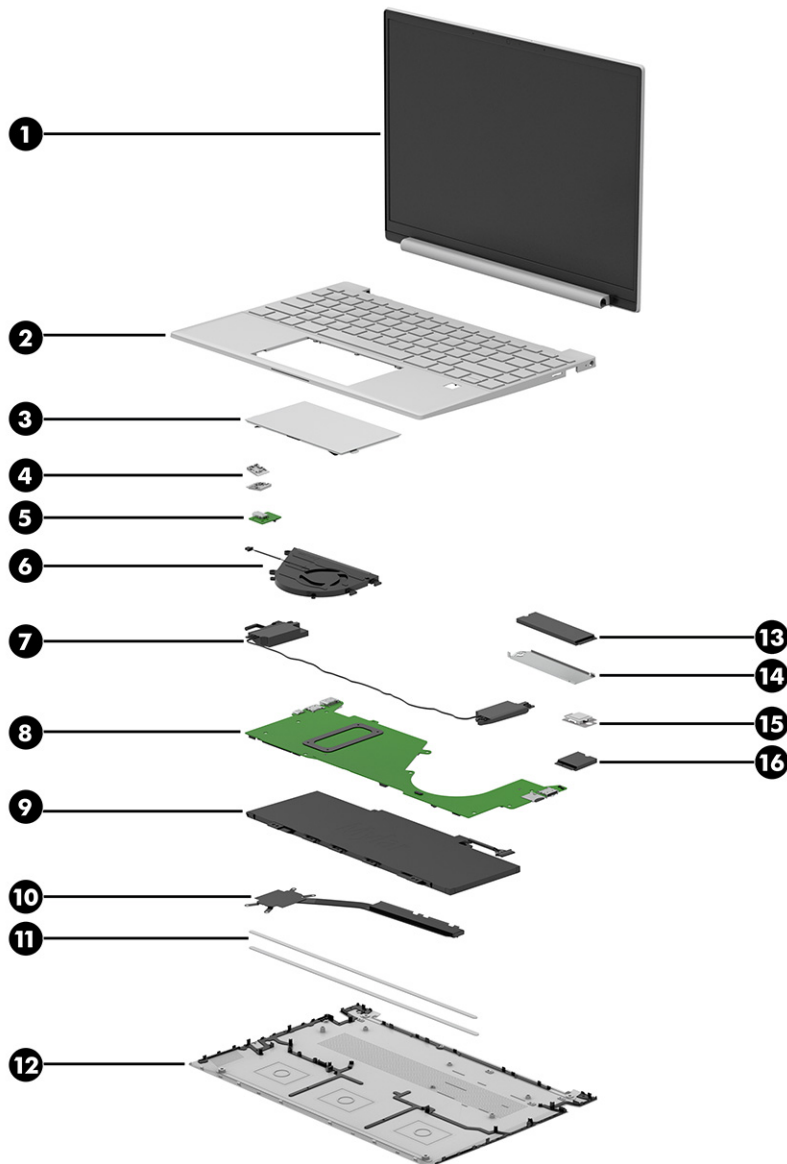

Table 3-1 Computer major component descriptions and part numbers

Item	Component	Spare part number
(1)	Display assembly NOTE: Display assemblies are offered as spare parts only at a subcomponent level. For more information, see Display assembly subcomponents on page 17 .	not available as a spare part
(2)	Keyboard NOTE: For a list of keyboard country codes, see Top cover with keyboard on page 54 .	
	Not backlit, natural silver	M52829-xx1
	Backlit, natural silver	M52830-xx1
	Backlit, warm gold	M52831-xx1
	Backlit, ceramic white	M52832-xx1
	Backlit, pale rose gold	M52833-xx1
(3)	Touchpad NOTE: The touchpad cable is available using spare part number M52811-001.	
	Natural silver	M52799-001
	Ceramic white	M52800-001
	Pale rose gold	M52801-001
	Warm gold	M52802-001
(4)	USB door	
	Natural silver	M52790-001
	Ceramic white	M52791-001
	Pale rose gold	M52792-001
	Warm gold	M52793-001
(5)	Audio board NOTE: The audio board cable is available using spare part number M52812-001.	M52798-001
(6)	Fan	M52816-001
(7)	Speakers (left and right)	M52821-001
(8)	System board (includes processor; for use in models with discrete graphics memory) All system boards use the following part numbers: xxxxxx-001: Non-Windows operating system xxxxxx-601: Windows 10 operating system	
	AMD Ryzen7 5800U processor and 16 GB of system memory	M52827-xx1
	AMD Ryzen7 5800U processor and 8 GB of system memory	M52828-xx1
	AMD Ryzen5 5600U processor and 16 GB of system memory	M52825-xx1
	AMD Ryzen5 5600U processor and 8 GB of system memory	M52826-xx1
(9)	Battery (3 cell, 43 Whr)	M24648-005

Table 3-1 Computer major component descriptions and part numbers (continued)

Item	Component	Spare part number
(10)	Heat sink	M52815-001
(11)	Rubber Foot Kit	
	Gray	M52818-001
	Pale rose gold	M52819-001
	Warm gold	M52820-001
(12)	Bottom cover	
	Natural silver	M52805-001
	Ceramic white	M52806-001
	Pale rose gold	M52807-001
	Warm gold	M52808-001
(13)	Solid-state drive	
	1 TB, PCIe	L85370-005
	512 GB, PCIe	L85364-005
	256 GB, PCIe	L85354-005
(14)	Solid-state drive cover	not available as a spare part
(15)	Fingerprint reader	
	NOTE: The fingerprint reader cable is available using spare part number M52810-001.	
	Natural silver	M52794-001
	Ceramic white	M52795-001
	Pale rose gold	M52796-001
	Warm gold	M52797-001
(16)	WLAN module	
	Realtek RTL8821CE-M 802.11ac 1 × 1 Wi-Fi + Bluetooth 4.2	M09870-005
	Realtek Wi-Fi 6 RTL8852AE + Bluetooth 5.2	M34027-005
	Realtek Wi-Fi 6 RTL8852AE-VT + Bluetooth 5.2	M34029-005
	Power connector (DC-in) cable (not illustrated)	M45022-001

Display assembly subcomponents

To identify the display assembly subcomponents, use this illustration and table.

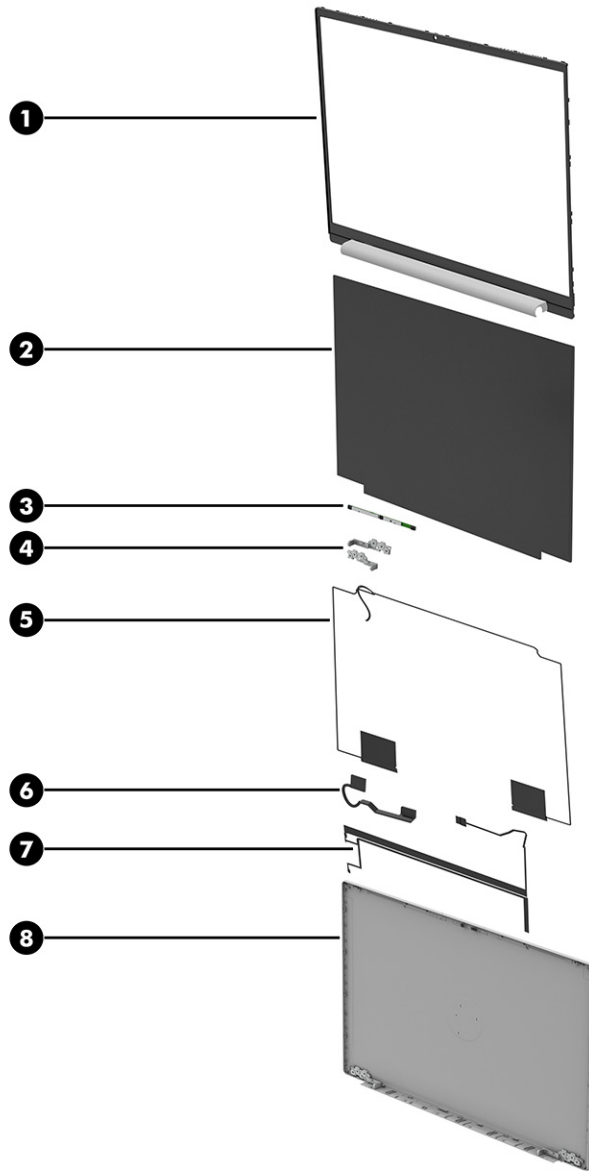

Table 3-2 Display component descriptions and part numbers

Item	Component	Spare part number
(1)	Display bezel	
	Natural silver	M52785-001
	Ceramic white	M52786-001
	Pale rose gold	M52787-001
	Warm gold	M52788-001
(2)	Display panel	
	WQXGA	M52803-001
	WUXGA	M52804-001

Table 3-2 Display component descriptions and part numbers (continued)

Item	Component	Spare part number	
(3)	Camera module	M52835-001	
(4)	Hinges (includes left and right display hinges)	M52789-001	
(5)	Wireless antenna kit (dual)	M52780-001	
	Wireless antenna kit (single) (not illustrated)	M52779-001	
(6)	Display panel cable		
	For use with WUXGA panels	M52813-001	
	For use with WQXGA panels	M52814-001	
(7)	Camera cable	M52809-001	
(8)	Display back cover		
	For use on models with dual wireless antennas:		
	• Natural silver	M52781-001	
	• Ceramic white	M52782-001	
	• Pale rose gold	M52783-001	
	• Warm gold	M52784-001	
	For use on models with a single wireless antenna:		
	• Natural silver	M52957-001	
	• Ceramic white	M52958-001	
	• Pale rose gold	M52959-001	
	• Warm gold	M52960-001	
		Adhesive tape kit (includes display panel adhesive and display bezel adhesive; not illustrated)	M52817-001

Cables

To identify the cables, use this illustration and table.

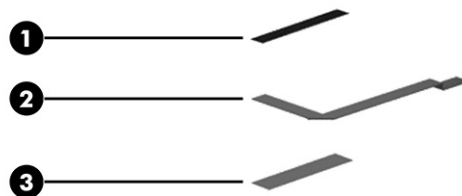
**Table 3-3** Cable descriptions and part numbers

Item	Component	Spare part number
(1)	Fingerprint reader board cable	M52810-001
(2)	Touchpad cable	M52811-001

Table 3-3 Cable descriptions and part numbers (continued)

Item	Component	Spare part number
(3)	Audio cable	M52812-001

Miscellaneous parts

To identify the miscellaneous parts, use this table.

Table 3-4 Miscellaneous part descriptions and part numbers

Component	Spare part number
AC adapters	
65 W HP Smart AC adapter (non-PFC, EM, RC, 4.5 mm)	913691-850
45 W HP Smart AC adapter (non-PFC, RC, 4.5 mm, nonslim)	741727-001
65 W HP Smart AC adapter (non-PFC, 3 pin, 4.5 mm)	710412-001
Adapters	
HP USB-C®-to-RJ-45 adapter	918779-001
HP USB 3.0-to-gigabit adapter	914031-001
HP HDMI-to-VGA adapter	701943-001
HP USB-C-to-VGA adapter	831751-001
HP USB Type-C-to-USB Type-A	833960-001
Hubs	
Hub, HP USB Type-C-to-USB Type-A	916838-001
Hub, HP USB-C-to-multiport	919666-001
Hub, HP Elite USB-C multiport	L39572-001
Screw Kit	M52822-001
External DVD±RW drive	747080-001
Duckhead power cord	
Japan	L33157-001
Power cords (C5, 1.0 m [3.3 ft])	
Argentina	L19357-001
Australia	L19358-001
Denmark	L19360-001
Europe (Austria, Belgium, Finland, France, Germany, the Netherlands, Norway, and Sweden)	L19361-001
India	L19363-001
Israel	L19362-001
Italy	L19364-001
Japan	L19365-001

Table 3-4 Miscellaneous part descriptions and part numbers (continued)

Component	Spare part number
North America	L19367-001
People's Republic of China	L19368-001
South Africa	L19369-001
South Korea	L19366-001
Switzerland	L19370-001
Taiwan	L19372-001
Thailand	L19371-001
United Kingdom	L19373-001

4 Removal and replacement procedures preliminary requirements

Use this information to properly prepare to disassemble and reassemble the computer.

Tools required

You need the following tools to complete the removal and replacement procedures:

- Tweezers
- Nonconductive, nonmarking pry tool
- Magnetic Phillips P1 screwdriver

Service considerations

The following sections include some of the considerations that you must keep in mind during disassembly and assembly procedures.



NOTE: As you remove each subassembly from the computer, place the subassembly (and all accompanying screws) away from the work area to prevent damage.

Plastic parts

Using excessive force during disassembly and reassembly can damage plastic parts.

Cables and connectors

Handle cables with extreme care to avoid damage.



IMPORTANT: When servicing the computer, be sure that cables are placed in their proper locations during the reassembly process. Improper cable placement can damage the computer.

Apply only the tension required to unseat or seat the cables during removal and insertion. Handle cables by the connector whenever possible. In all cases, avoid bending, twisting, or tearing cables. Be sure that cables are routed so that they cannot be caught or snagged as you remove or replace parts. Handle flex cables with extreme care; these cables tear easily.

Drive handling

Note the following guidelines when handling drives.



IMPORTANT: Drives are fragile components. Handle them with care. To prevent damage to the computer, damage to a drive, or loss of information, observe these precautions:

- Before removing or inserting a hard drive, shut down the computer. If you are unsure whether the computer is off or in Hibernation, turn the computer on, and then shut it down through the operating system.

- Before handling a drive, be sure that you are discharged of static electricity. While handling a drive, avoid touching the connector.
 - Before removing an optical drive, be sure that a disc is not in the drive, and be sure that the optical drive tray is closed.
 - Handle drives on surfaces covered with at least 2.54 cm (1 inch) of shock-proof foam.
 - Avoid dropping drives from any height onto any surface.
 - After removing a hard drive or an optical drive, place it in a static-proof bag.
 - Avoid exposing an internal hard drive to products that have magnetic fields, such as monitors or speakers.
 - Avoid exposing a drive to temperature extremes or liquids.
 - If a drive must be mailed, place the drive in a bubble pack mailer or other suitable form of protective packaging, and label the package “FRAGILE.”
-

Electrostatic discharge information

A sudden discharge of static electricity from your finger or other conductor can destroy static-sensitive devices or microcircuitry. Often the spark is neither felt nor heard, but damage occurs. An electronic device exposed to electrostatic discharge (ESD) might not appear to be affected at all and can work perfectly throughout a normal cycle. The device might function normally for a while, but it has been degraded in the internal layers, reducing its life expectancy.

Networks built into many integrated circuits provide some protection, but in many cases, the discharge contains enough power to alter device parameters or melt silicon junctions.



IMPORTANT: To prevent damage to the device when you remove or install internal components, observe these precautions:

- Keep components in their electrostatic-safe containers until you are ready to install them.
 - Before touching an electronic component, discharge static electricity by using the guidelines described in [Personal grounding methods and equipment on page 24](#).
 - Avoid touching pins, leads, and circuitry. Handle electronic components as little as possible.
 - If you remove a component, place it in an electrostatic-safe container.
-

Generating static electricity

Follow these static electricity guidelines:

- Different activities generate different amounts of static electricity.
- Static electricity increases as humidity decreases.

Table 4-1 Static electricity occurrence based on activity and humidity

Event	Relative humidity		
	55%	40%	10%
Walking across carpet	7,500 V	15,000 V	35,000 V
Walking across vinyl floor	3,000 V	5,000 V	12,000 V
Motions of bench worker	400 V	800 V	6,000 V
Removing dual in-line packages (DIPs) from plastic tube	400 V	700 V	2,000 V
Removing DIPs from vinyl tray	2,000 V	4,000 V	11,500 V
Removing DIPs from polystyrene foam	3,500 V	5,000 V	14,500 V
Removing bubble pack from PCB (printed circuit board)	7,000 V	20,000 V	26,500 V
Packing PCBs in foam-lined box	5,000 V	11,000 V	21,000 V
Multiple electric components can be packaged together in plastic tubes, trays, or polystyrene foam.			



NOTE: As little as 700 V of static electricity can degrade a product.

Preventing electrostatic damage to equipment

Many electronic components are sensitive to ESD. Circuitry design and structure determine the degree of sensitivity.

The following packaging and grounding precautions are necessary to prevent static electricity damage to electronic components:

- To avoid hand contact, transport products in static-safe containers such as tubes, bags, or boxes.
- Protect all electrostatic parts and assemblies with conductive or approved containers or packaging.
- Keep electrostatic-sensitive parts in their containers until they arrive at static-free stations.
- Place items on a grounded surface before removing them from their container.
- Always be properly grounded when touching a sensitive component or assembly.
- Avoid contact with pins, leads, or circuitry.
- Place reusable electrostatic-sensitive parts from assemblies in protective packaging or conductive foam.

Personal grounding methods and equipment

Using certain equipment can prevent static electricity damage to electronic components.

- **Wrist straps** are flexible straps with a maximum of $1\text{ M}\Omega \pm 10\%$ resistance in the ground cords. To provide proper ground, a strap must be worn snug against bare skin. The ground cord must be connected and fit snugly into the banana plug connector on the grounding mat or workstation.
- You can use **heel straps, toe straps, and boot straps** at standing workstations. These straps are compatible with most types of shoes or boots. On conductive floors or dissipative floor mats, use them on both feet with a maximum of $1\text{ M}\Omega \pm 10\%$ resistance between the operator and ground.

Table 4-2 Static shielding protection levels

Static shielding protection levels	
Method	Voltage
Antistatic plastic	1,500
Carbon-loaded plastic	7,500
Metallized laminate	15,000

Grounding the work area

To prevent static damage at the work area, follow these precautions:

- Cover the work surface with approved static-dissipative material.
- Use a wrist strap connected to a properly grounded work surface and use properly grounded tools and equipment.
- Use static-dissipative mats, foot straps, or air ionizers to give added protection.
- Handle electrostatic sensitive components, parts, and assemblies by the case or PCB laminate. Handle them only at static-free work areas.
- Turn off power and input signals before inserting and removing connectors or test equipment.
- Use fixtures made of static-safe materials when fixtures must directly contact dissipative surfaces.
- Keep the work area free of nonconductive materials, such as ordinary plastic assembly aids and polystyrene foam.
- Use conductive field service tools, such as cutters, screwdrivers, and vacuums.
- Avoid contact with pins, leads, or circuitry.

Recommended materials and equipment

HP recommends certain materials and equipment to prevent static electricity:

- Antistatic tape
- Antistatic smocks, aprons, or sleeve protectors
- Conductive bins and other assembly or soldering aids
- Conductive foam
- Conductive tabletop workstations with ground cord of $1\text{ M}\Omega \pm 10\%$ resistance
- Static-dissipative table or floor mats with hard tie to ground
- Field service kits
- Static awareness labels
- Wrist straps and footwear straps providing $1\text{ M}\Omega \pm 10\%$ resistance
- Material handling packages

- Conductive plastic bags
- Conductive plastic tubes
- Conductive tote boxes
- Opaque shielding bags
- Transparent metallized shielding bags
- Transparent shielding tubes

Cleaning your computer

Cleaning your computer regularly removes dirt and debris so that your device continues to operate at its best. Use the following information to safely clean the external surfaces of your computer.

Enabling HP Easy Clean (select products only)

HP Easy Clean helps you to avoid accidental input while you clean the computer surfaces. This software disables devices such as the keyboard, touch screen, and touchpad for a preset amount of time so that you can clean all computer surfaces.

1. Start HP Easy Clean in one of the following ways:
 - Select the **Start** menu, and then select **HP Easy Clean**.
– or –
 - Select the **HP Easy Clean** icon in the taskbar.
– or –
 - Select **Start**, and then select the **HP Easy Clean** tile.
2. Now that your device is disabled for a short period, see [Removing dirt and debris from your computer on page 26](#) for the recommended steps to clean the high-touch, external surfaces on your computer. After you remove the dirt and debris, you can also clean the surfaces with a disinfectant. See [Cleaning your computer with a disinfectant on page 27](#) for guidelines to help prevent the spread of harmful bacteria and viruses.

Removing dirt and debris from your computer

Here are the recommended steps to clean dirt and debris from your computer.

For computers with wood veneer, see [Caring for wood veneer \(select products only\) on page 28](#).

1. Wear disposable gloves made of latex (or nitrile gloves, if you are latex-sensitive) when cleaning the surfaces.
2. Turn off your device and unplug the power cord and other connected external devices. Remove any installed batteries from items such as wireless keyboards.

⚠ CAUTION: To prevent electric shock or damage to components, never clean a product while it is turned on or plugged in.

3. Moisten a microfiber cloth with water. The cloth should be moist, but not dripping wet.

 **IMPORTANT:** To avoid damaging the surface, avoid abrasive cloths, towels, and paper towels.

4. Wipe the exterior of the product gently with the moistened cloth.

 **IMPORTANT:** Keep liquids away from the product. Avoid getting moisture in any openings. If liquid makes its way inside your HP product, it can cause damage to the product. Do not spray liquids directly on the product. Do not use aerosol sprays, solvents, abrasives, or cleaners containing hydrogen peroxide or bleach that might damage the finish.

5. Start with the display (if applicable). Wipe carefully in one direction, and move from the top of the display to the bottom. Finish with any flexible cables, like power cord, keyboard cable, and USB cables.
6. Be sure that surfaces have completely air-dried before turning the device on after cleaning.
7. Discard the gloves after each cleaning. Clean your hands immediately after you remove the gloves.

See [Cleaning your computer with a disinfectant on page 27](#) for recommended steps to clean the high-touch, external surfaces on your computer to help prevent the spread of harmful bacteria and viruses.

Cleaning your computer with a disinfectant

The World Health Organization (WHO) recommends cleaning surfaces, followed by disinfection, as a best practice for preventing the spread of viral respiratory illnesses and harmful bacteria.

After cleaning the external surfaces of your computer using the steps in [Removing dirt and debris from your computer on page 26](#), [Caring for wood veneer \(select products only\) on page 28](#), or both, you might also choose to clean the surfaces with a disinfectant. A disinfectant that is within HP's cleaning guidelines is an alcohol solution consisting of 70% isopropyl alcohol and 30% water. This solution is also known as rubbing alcohol and is sold in most stores.

Follow these steps when disinfecting high-touch, external surfaces on your computer:

1. Wear disposable gloves made of latex (or nitrile gloves, if you are latex-sensitive) when cleaning the surfaces.
2. Turn off your device and unplug the power cord and other connected external devices. Remove any installed batteries from items such as wireless keyboards.

 **CAUTION:** To prevent electric shock or damage to components, never clean a product while it is turned on or plugged in.

3. Moisten a microfiber cloth with a mixture of 70% isopropyl alcohol and 30% water. The cloth should be moist, but not dripping wet.

 **CAUTION:** Do not use any of the following chemicals or any solutions that contain them, including spray-based surface cleaners: bleach, peroxides (including hydrogen peroxide), acetone, ammonia, ethyl alcohol, methylene chloride, or any petroleum-based materials, such as gasoline, paint thinner, benzene, or toluene.

 **IMPORTANT:** To avoid damaging the surface, avoid abrasive cloths, towels, and paper towels.

4. Wipe the exterior of the product gently with the moistened cloth.

 **IMPORTANT:** Keep liquids away from the product. Avoid getting moisture in any openings. If liquid makes its way inside your HP product, it can cause damage to the product. Do not spray liquids directly

on the product. Do not use aerosol sprays, solvents, abrasives, or cleaners containing hydrogen peroxide or bleach that might damage the finish.

5. Start with the display (if applicable). Wipe carefully in one direction, and move from the top of the display to the bottom. Finish with any flexible cables, like power cord, keyboard cable, and USB cables.
6. Be sure that surfaces have completely air-dried before turning the device on after cleaning.
7. Discard the gloves after each cleaning. Clean your hands immediately after you remove the gloves.

Caring for wood veneer (select products only)

Your product might feature high-quality wood veneer. As with all natural wood products, proper care is important for best results over the life of the product. Because of the nature of natural wood, you might see unique variations in the grain pattern or subtle variations in color, which are normal.

- Clean the wood with a dry, static-free microfiber cloth or chamois.
- Avoid cleaning products containing substances such as ammonia, methylene chloride, acetone, turpentine, or other petroleum-based solvents.
- Do not expose the wood to sun or moisture for long periods of time.
- If the wood becomes wet, dry it by dabbing with an absorbent, lint-free cloth.
- Avoid contact with any substance that might dye or discolor the wood.
- Avoid contact with sharp objects or rough surfaces that might scratch the wood.

See [Removing dirt and debris from your computer on page 26](#) for the recommended steps to clean the high-touch, external surfaces on your computer. After you remove the dirt and debris, you can also clean the surfaces with a disinfectant. See [Cleaning your computer with a disinfectant on page 27](#) for sanitizing guidelines to help prevent the spread of harmful bacteria and viruses.

Packaging and transporting guidelines

Follow these grounding guidelines when packaging and transporting equipment:

- To avoid hand contact, transport products in static-safe tubes, bags, or boxes.
- Protect ESD-sensitive parts and assemblies with conductive or approved containers or packaging.
- Keep ESD-sensitive parts in their containers until the parts arrive at static-free workstations.
- Place items on a grounded surface before removing items from their containers.
- Always be properly grounded when touching a component or assembly.
- Store reusable ESD-sensitive parts from assemblies in protective packaging or nonconductive foam.
- Use transporters and conveyors made of antistatic belts and roller bushings. Be sure that mechanized equipment used for moving materials is wired to ground and that proper materials are selected to avoid static charging. When grounding is not possible, use an ionizer to dissipate electric charges.

Accessing support information

To find the HP support that you need, use this information.

Table 4-3 Support information locations



Service consideration	Path to access information
Records of reported failure incidents stored on the computer	<p>Windows®:</p> <p>Preoperating system failures are logged in the BIOS Event Log. To view the BIOS Event Log:</p> <ol style="list-style-type: none">1. Press the power button.2. Immediately and repeatedly press esc when the power button light turns white. <p>NOTE: If you do not press esc at the appropriate time, you must restart the computer and again repeatedly press esc when the power button light turns white to access the utility.</p> <ol style="list-style-type: none">3. Press f10 to enter the BIOS setup.4. (On commercial products) Under the Main tab, select BIOS event log, and then select View BIOS Event Log. <p>- or -</p> <p>(On consumer products) Under the Main tab, select System Log.</p> <p>Post-operating system failures are logged in the Event Viewer.</p> <ol style="list-style-type: none">1. Turn on the computer and allow the operating system to open.2. Select the search icon  in the taskbar.3. Type <code>Event Viewer</code>, and then press enter.4. Select the log from the left panel. Details display in the right panel. <p>Chrome™:</p> <ol style="list-style-type: none">1. Go to support.google.com/chrome.2. Search <code>collect Chrome device logs</code>.
Technical bulletins	<p>To locate technical bulletins:</p> <ol style="list-style-type: none">1. Go to www.hp.com.2. Place the cursor over Problem solving to display more options.3. Select Support & Troubleshooting.4. Type the serial number, product number, or product name to go to the product support page.5. Select Advisories to view technical bulletins.
Repair professionals	<p>To locate repair professionals:</p> <ol style="list-style-type: none">1. Go to www.hp.com.2. Place the cursor over Support resources to display more options.3. Select Authorized service providers.

Table 4-3 Support information locations (continued)

Service consideration	Path to access information
Component and diagnosis information, failure detection, and required action	To locate diagnosis information and actions: <ol style="list-style-type: none"><li data-bbox="678 310 1439 342">1. Go to http://www.hp.com/go/techcenter/pcdiags.<li data-bbox="678 359 1439 390">2. Select Get Support.<li data-bbox="678 407 1439 464">3. Near the bottom of the window, select Notebook PCs, and then select your location.

5 Removal and replacement procedures for authorized service provider parts

This chapter provides removal and replacement procedures for authorized service provider parts.

 **IMPORTANT:** Only an authorized service provider should access the components described in this chapter. Accessing these parts can damage the computer or void the warranty.

 **NOTE:** Details about your computer, including model, serial number, product key, and length of warranty, are on the service tag at the bottom of your computer.

Component replacement procedures

To remove and replace computer components, use these procedures.

 **NOTE:** HP continually improves and changes product parts. For complete and current information about supported parts for your computer, go to <http://partsurfer.hp.com>, select your country or region, and then follow the on-screen instructions.

You must remove, replace, or loosen as many as 39 screws when you service the parts described in this chapter. Make special note of each screw size and location during removal and replacement.

Preparation for disassembly

To remove and replace computer components, use these procedures:

For initial safety procedures, see [Removal and replacement procedures preliminary requirements on page 22](#).

1. Turn off the computer. If you are unsure whether the computer is off or in Hibernation, turn the computer on, and then shut it down through the operating system.
2. Disconnect the power from the computer by unplugging the power cord from the computer.
3. Disconnect all external devices from the computer.

Bottom cover

To remove the bottom cover and rubber feet, use this procedure and illustration.

Table 5-1 Bottom cover and rubber feet descriptions and part numbers

Description	Spare part number
Bottom cover, natural silver	M52805-001
Bottom cover, ceramic white	M52806-001
Bottom cover, pale rose gold	M52807-001
Bottom cover, warm gold	M52808-001
Rubber feet, gray	M52818-001

Table 5-1 Bottom cover and rubber feet descriptions and part numbers (continued)

Description	Spare part number
Rubber feet, pale rose gold	M52819-001
Rubber feet, warm gold	M52820-001

Before removing the bottom cover, prepare the computer for disassembly (see [Preparation for disassembly on page 31](#)).

Remove the bottom cover:

1. Peel the two rubber feet **(1)** off the bottom of the computer.
2. Remove the four Phillips M2.5 × 5.0 screws **(2)** and the Phillips M2.0 × 2.0 screw **(3)** from under the feet.

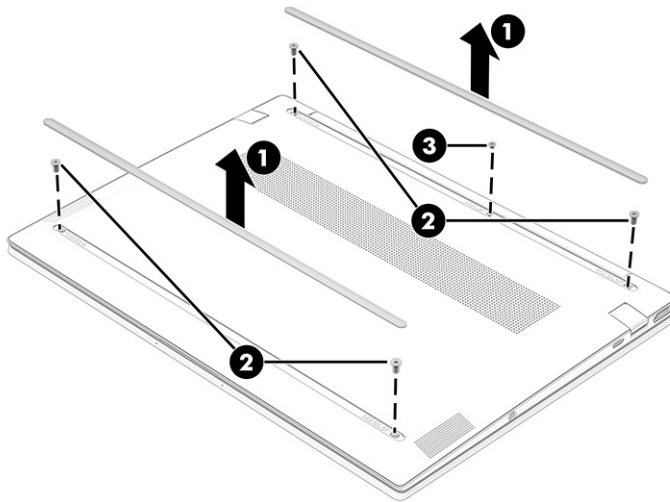

3. Starting near the hinges, use a plastic tool to release the bottom cover from the computer **(1)**, and then remove the cover from the computer **(2)**.

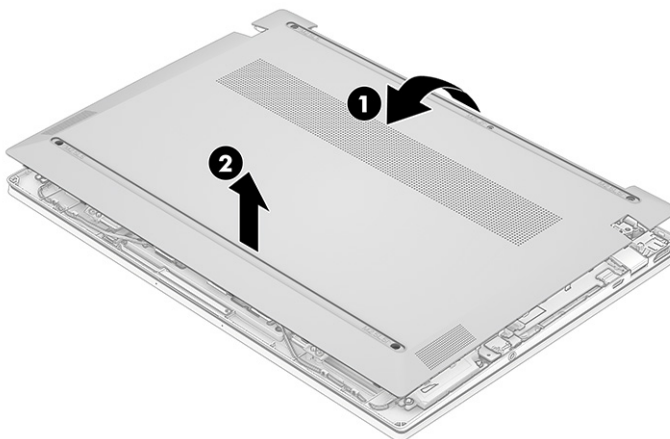

To replace the bottom cover, reverse the removal procedures.

Battery

To remove the battery, use this procedure and illustration.

Table 5-2 Battery description and part number

Description	Spare part number
3 cell, 43 Whr, Li-ion battery	M24648-005

 **WARNING!** To avoid personal injury and damage to the product:

- Do *not* puncture, twist, or crack the battery.
- Do *not* cause an external puncture or rupture to the battery. They can cause a short inside the battery, which can result in battery thermal runaway.
- Do *not* handle or touch the battery enclosure with sharp objects such as tweezers or pliers, which might puncture the battery.
- Do *not* compress or squeeze the battery case with tools or heavy objects stacked on top of the case. These actions can apply undue force on the battery.
- Do *not* touch the connectors with any metallic surface or object, such as metal tools, screws, or coins, which can cause shorting across the connectors.

Before removing the battery, follow these steps:

1. Prepare the computer for disassembly (see [Preparation for disassembly on page 31](#)).
2. Remove the bottom cover (see [Bottom cover on page 31](#)).

 **WARNING!** To reduce potential safety issues, use only the user-replaceable battery provided with the computer, a replacement battery provided by HP, or a compatible battery purchased from HP.

 **IMPORTANT:** Removing a battery that is the sole power source for the computer can cause loss of information. To prevent loss of information, save your work or shut down the computer through Windows before you remove the battery.

Remove the battery:

1. Disconnect the battery cable from the system board **(1)**.
2. Remove the four Phillips M2.0 × 3.5 screws **(2)** that secure the battery to the computer.
3. Remove the speaker cable from the clips along the bottom of the battery **(3)**.

4. Remove the battery from the computer (4).

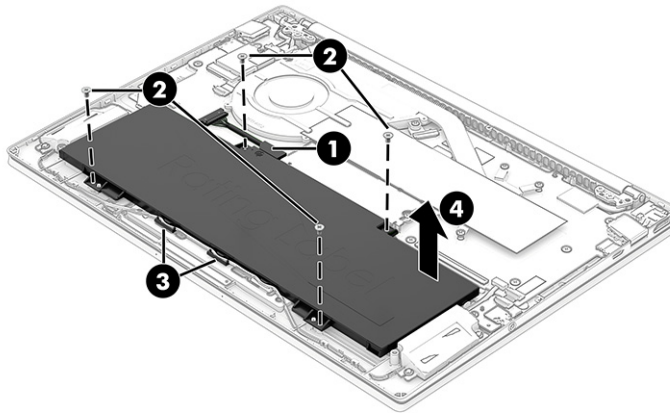

To replace the battery, reverse the removal procedures.

Solid-state drive

To remove the solid-state drive, use this procedure and illustration.

Table 5-3 Solid-state drive descriptions and part numbers

Description	Spare part number
1 TB, PCIe	L85370-005
512 GB, PCIe	L85364-005
256 GB, PCIe	L85354-005

Before removing the solid-state drive, follow these steps:

1. Prepare the computer for disassembly (see [Preparation for disassembly on page 31](#)).
2. Remove the bottom cover (see [Bottom cover on page 31](#)).
3. Disconnect the battery cable from the system board (see [Battery on page 33](#)).

Remove the solid-state drive:

1. Remove the Phillips M2.0 × 2.5 screw (1) that secures the cover over the solid-state drive, and then remove the cover (2).

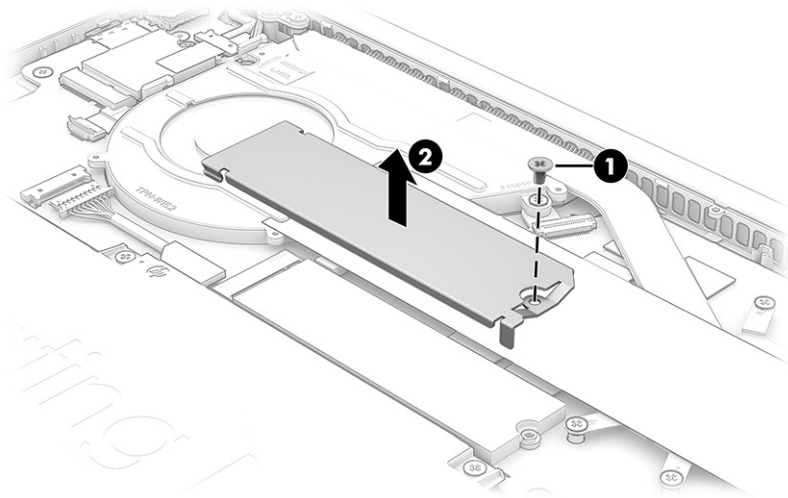

2. Pull the drive away from the socket to remove it.

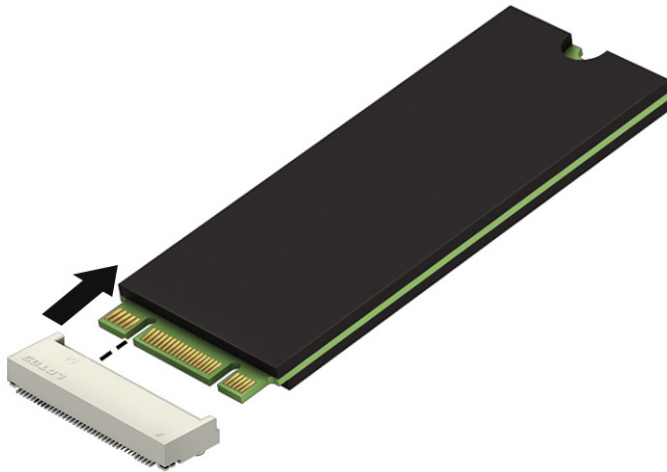

To install the solid-state drive, reverse the removal procedures.

 **NOTE:** Solid-state drives are designed with a notch to prevent incorrect insertion.

Speakers

To remove the speakers, use this procedure and illustration.

Table 5-4 Speaker description and part number

Description	Spare part number
Speaker Kit	M52821-001

Before removing the speakers, follow these steps:

1. Prepare the computer for disassembly (see [Preparation for disassembly on page 31](#)).

2. Remove the bottom cover (see [Bottom cover on page 31](#)).
3. Disconnect the battery cable from the system board (see [Battery on page 33](#)).

Remove the speakers:

1. Disconnect the speaker cable from the system board (1).
2. Remove the speaker cable from the clips along the bottom of the battery (2).
3. Remove the speakers from the computer (3).



NOTE: When installing the speakers, be sure that the rubber gaskets are installed in the screw holes (4).

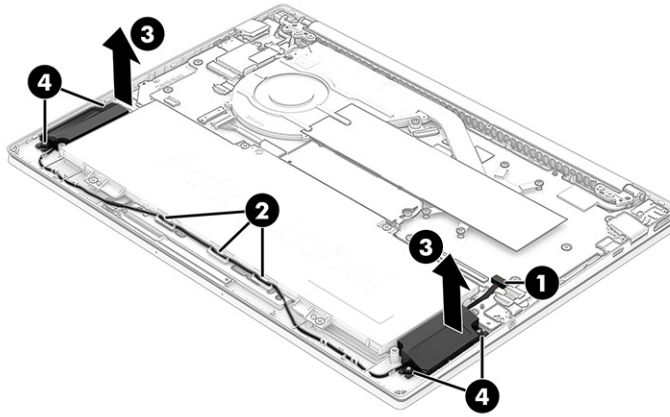

Reverse this procedure to install the speakers.

WLAN module

To remove the WLAN module, use this procedure and illustration.

Table 5-5 WLAN module descriptions and part numbers

Description	Spare part number
Realtek RTL8821CE-M 802.11ac 1 × 1 Wi-Fi + Bluetooth 4.2	M09870-005
Realtek Wi-Fi 6 RTL8852AE + Bluetooth 5.2	M34027-005
Realtek Wi-Fi 6 RTL8852AE-VT + Bluetooth 5.2	M34029-005



IMPORTANT: To prevent an unresponsive system, replace the wireless module only with a wireless module authorized for use in the computer by the governmental agency that regulates wireless devices in your country or region. If you replace the module and then receive a warning message, remove the module to restore device functionality, and then contact technical support.

Before removing the WLAN module, follow these steps:

1. Prepare the computer for disassembly (see [Preparation for disassembly on page 31](#)).
2. Remove the bottom cover (see [Bottom cover on page 31](#)).

3. Disconnect the battery cable from the system board (see [Battery on page 33](#)).

Remove the WLAN module:

1. Remove the plastic that covers the antenna connectors (1).
2. Carefully disconnect the antenna cables from the module (2).
3. Remove the Phillips M2.0 × 2.5 screw (3), and then remove the WLAN module (4).

 **NOTE:** Models have either one or two WLAN antennas. On models with two antennas, the #1 white WLAN antenna cable connects to the WLAN module #1 Main terminal. The #2 black WLAN antenna cable connects to the WLAN module #1 Aux terminal.

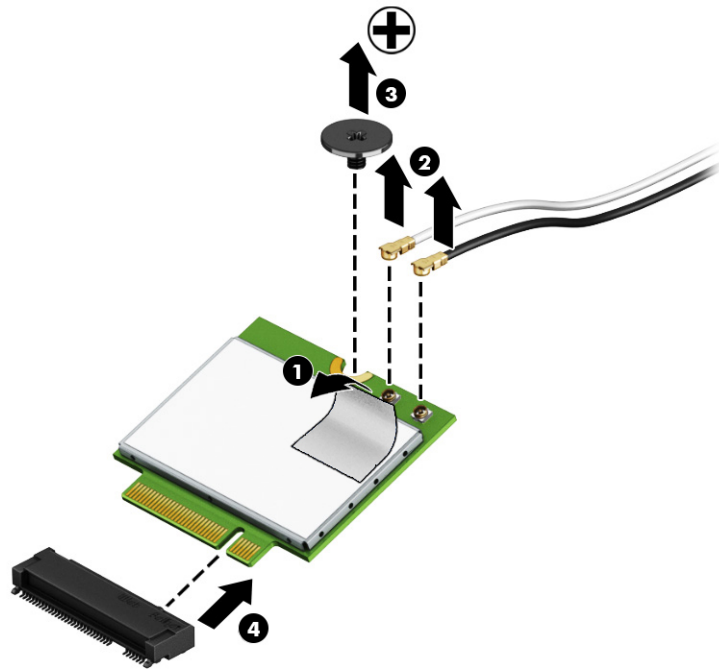

4. If the WLAN antenna is not connected to the terminal on the WLAN module, you must install a protective sleeve on the antenna connector, as shown in the following illustration.

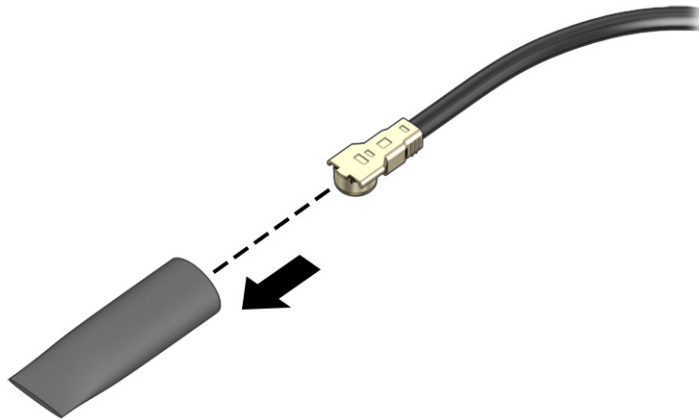

Reverse this procedure to install the WLAN module.

Touchpad

To remove the touchpad, use this procedure and illustration.

Table 5-6 Touchpad description and part number

Description	Spare part number
Touchpad, natural silver	M52799-001
Touchpad, ceramic white	M52800-001
Touchpad, pale rose gold	M52801-001
Touchpad, warm gold	M52802-001
Touchpad cable	M52811-001

Before removing the touchpad, follow these steps:

1. Prepare the computer for disassembly (see [Preparation for disassembly on page 31](#)).
2. Remove the bottom cover (see [Bottom cover on page 31](#)).
3. Remove the battery (see [Battery on page 33](#)).

Remove the touchpad:

1. Disconnect the touchpad cable from the ZIF connector on the touchpad **(1)**.
2. Remove the rubber piece that covers the middle screw **(2)**.
3. Remove the three Phillips M2.0 × 2.0 screws **(3)** that secure the touchpad to the computer.

4. Lift the top of the touchpad up to about 45° (4), and then pull the touchpad into the computer to remove it (5).

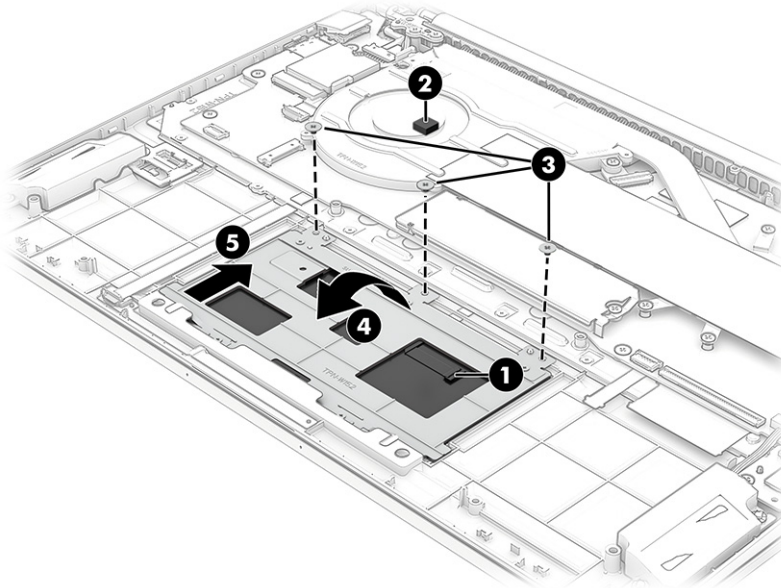

Reverse this procedure to install the touchpad.

Fingerprint reader

To remove the fingerprint reader, use this procedure and illustration.

Table 5-7 Fingerprint reader description and part number

Description	Spare part number
Fingerprint reader, natural silver	M52794-001
Fingerprint reader, ceramic white	M52795-001
Fingerprint reader, pale rose gold	M52796-001
Fingerprint reader, warm gold	M52797-001
Fingerprint reader cable	M52810-001

Before removing the fingerprint reader, follow these steps:

1. Prepare the computer for disassembly (see [Preparation for disassembly on page 31](#)).
2. Remove the bottom cover (see [Bottom cover on page 31](#)).
3. Remove the battery (see [Battery on page 33](#)).
4. Remove the fan (see [Fan on page 40](#)).
5. Remove the system board (see [System board on page 45](#)).

Remove the fingerprint reader:

1. Disconnect the fingerprint reader cable to the system board (1).

2. Remove the Phillips M2.0 × 2.0 screw (2) that secures the fingerprint reader bracket to the computer.
3. Remove the bracket from on top of the fingerprint reader (3).
4. Remove the fingerprint reader from the computer (4).

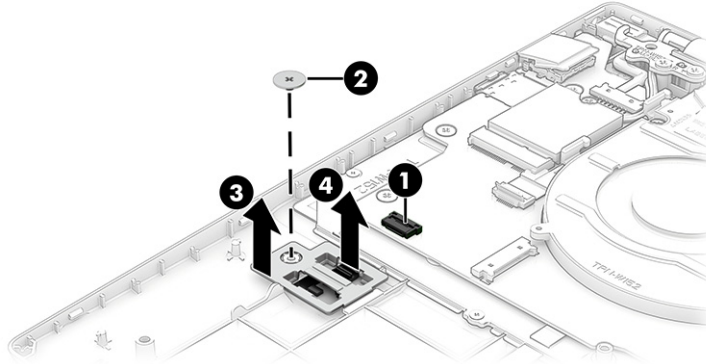

Reverse this procedure to install the fingerprint reader.

Fan

To remove the fan, use this procedure and illustration.

Table 5-8 Fan description and part number

Description	Spare part number
Fan	M52816-001

Before removing the fan, follow these steps:

1. Prepare the computer for disassembly (see [Preparation for disassembly on page 31](#)).
2. Remove the bottom cover (see [Bottom cover on page 31](#)).
3. Disconnect the battery cable from the system board (see [Battery on page 33](#)).

Remove the fan:

1. Remove the camera cable from the clips on the side of the fan (1).
2. Remove the three Phillips M2.0 × 3.5 screws (2) that secure the fan to the computer.
3. Disconnect the fan cable from the system board (3).
4. Remove the fan from the computer (4).

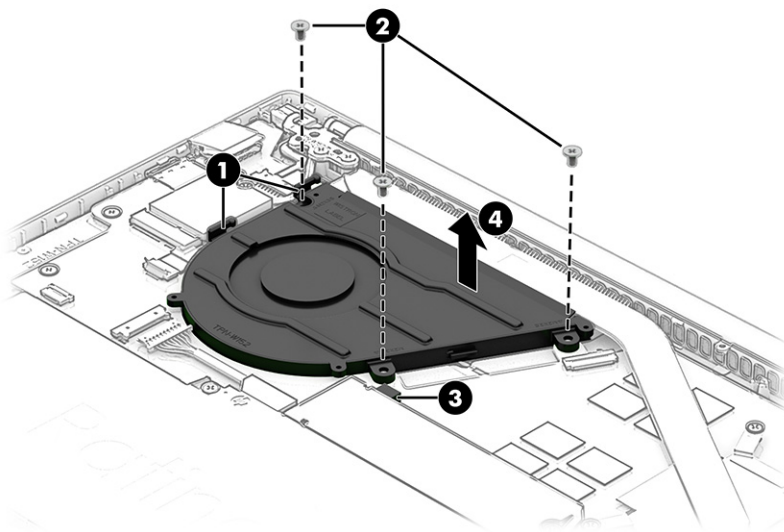

Reverse this procedure to install the fan.

Heat sink

To remove the heat sink, use this procedure and illustration.

Table 5-9 Heat sink descriptions and part numbers

Description	Spare part number
Heat sink	M52815-001

Before removing the heat sink, follow these steps:

1. Prepare the computer for disassembly (see [Preparation for disassembly on page 31](#)).
2. Remove the bottom cover (see [Bottom cover on page 31](#)).
3. Disconnect the battery cable from the system board (see [Battery on page 33](#)).

Remove the heat sink:

1. Remove the foam pad from the system board (1).
2. In the order indicated on the heat sink, remove the four Phillips M2.0 × 4.0 screws (2) that secure the heat sink to the system board.

3. Remove the heat sink (3).

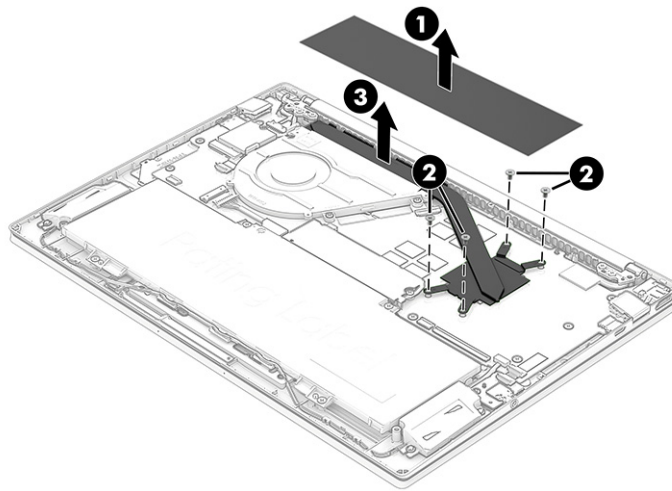

4. Thoroughly clean the thermal material from the surface of the heat sink (1) and the system board component (2) each time the heat sink is removed. Replacement thermal material is included with the heat sink and system board spare part kits.

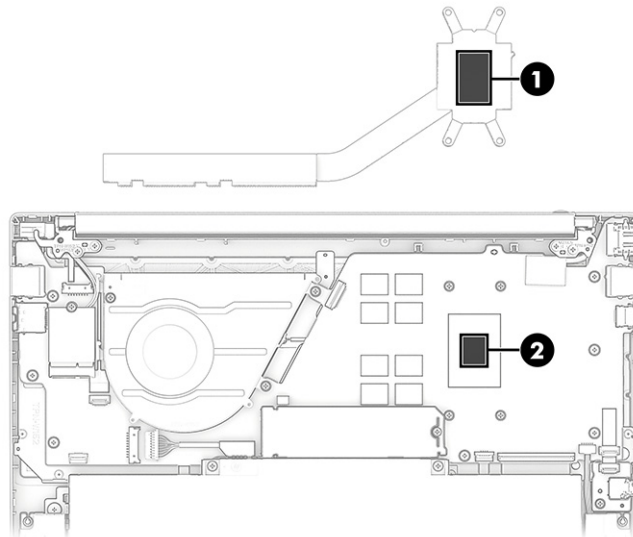

Reverse this procedure to install the heat sink.

Light bar

To remove the light bar, use this procedure and illustration.

Table 5-10 Light bar description and part number

Description	Spare part number
Light bar	M52695-001

Before removing the light bar, follow these steps:

1. Prepare the computer for disassembly (see [Preparation for disassembly on page 31](#)).
2. Remove the bottom cover (see [Bottom cover on page 31](#)).
3. Remove the battery (see [Battery on page 33](#)).

Remove the light bar:

1. Disconnect the cable from the ZIF connector on the light bar **(1)**.
2. Use tweezers to remove the light bar from the computer **(2)**.

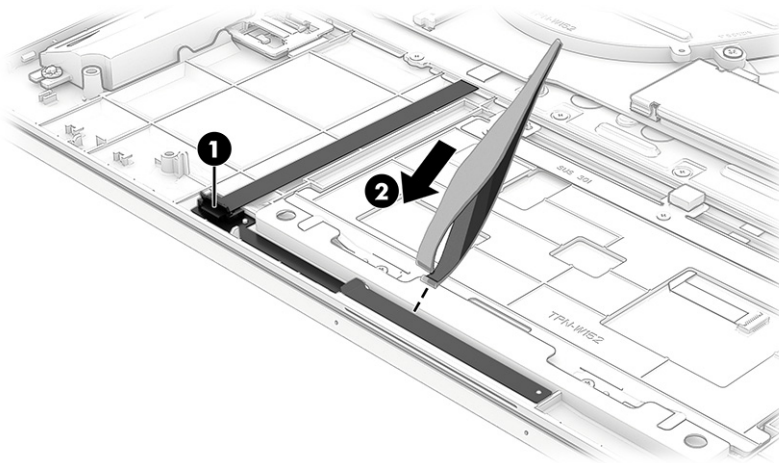

Reverse this procedure to install the light bar.

Audio board

To remove the audio board, use this procedure and illustration.

Table 5-11 Audio board description and part number

Description	Spare part number
Audio board	M52798-001
Audio board cable	M52812-001

Before removing the audio board, follow these steps:

1. Prepare the computer for disassembly (see [Preparation for disassembly on page 31](#)).
2. Remove the bottom cover (see [Bottom cover on page 31](#)).
3. Disconnect the battery cable from the system board (see [Battery on page 33](#)).

Remove the audio board:

1. Disconnect the cable from the ZIF connector on the audio board **(1)**.
2. Remove the Phillips M2.0 × 3.0 screw **(2)** that secures the board to the computer.

3. Remove the board from the computer (3).

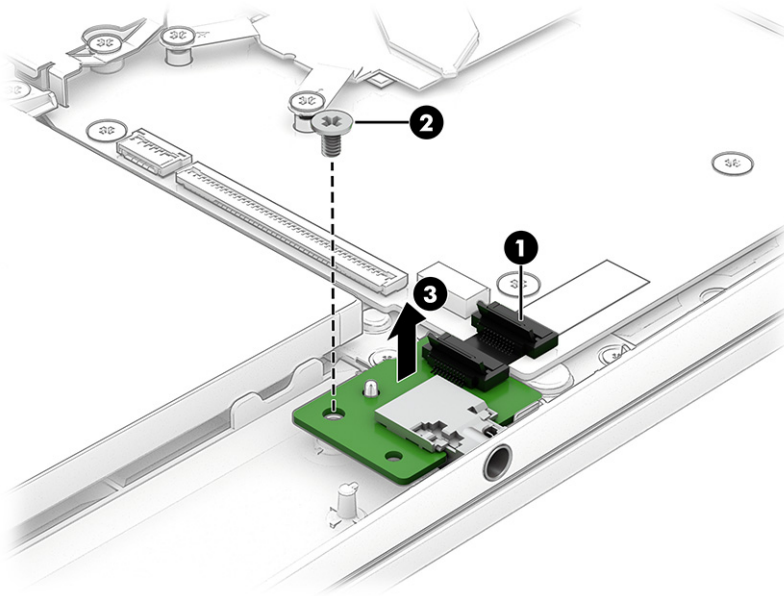

Reverse this procedure to install the audio board.

USB door

To remove the USB door, use this procedure and illustration.

Table 5-12 USB door description and part number

Description	Spare part number
USB door, natural silver	M52790-001
USB door, ceramic white	M52791-001
USB door, pale rose gold	M52792-001
USB door, warm gold	M52793-001

Before removing the USB door, follow these steps:

1. Prepare the computer for disassembly (see [Preparation for disassembly on page 31](#)).
2. Remove the bottom cover (see [Bottom cover on page 31](#)).
3. Disconnect the battery cable from the system board (see [Battery on page 33](#)).

Remove the USB door:

1. From the inside of the computer, use a tool to push the USB door toward the outside of the computer to release it (1).

2. Remove the USB door from the computer (2).

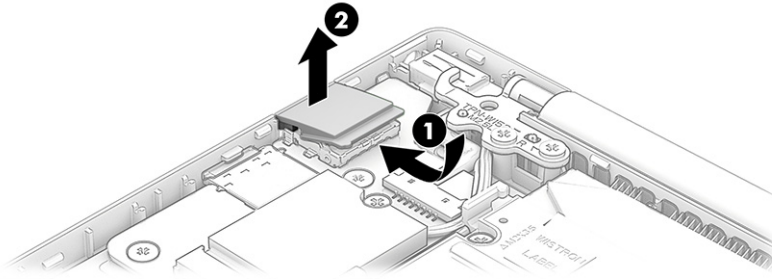

Reverse this procedure to install the USB door.

System board

To remove the system board, use these procedures and illustrations.

Table 5-13 System board descriptions and part numbers

Description	Spare part number
System board (includes processor):	
All system boards use the following part numbers:	
xxxxxx-001: Non-Windows operating system	
xxxxxx-601: Windows 10 operating system	
AMD Ryzen7 5800U processor and 16 GB of system memory	M52827-xx1
AMD Ryzen7 5800U processor and 8 GB of system memory	M52828-xx1
AMD Ryzen5 5600U processor and 16 GB of system memory	M52825-xx1
AMD Ryzen5 5600U processor and 8 GB of system memory	M52826-xx1

Before removing the system board, follow these steps:

1. Prepare the computer for disassembly (see [Preparation for disassembly on page 31](#)).
2. Remove the bottom cover (see [Bottom cover on page 31](#)).
3. Remove the battery (see [Battery on page 33](#)).
4. Remove the solid-state drive (see [Solid-state drive on page 34](#)).
5. Remove the fan (see [Fan on page 40](#)).

When you replace the system board, be sure to remove the following components (as applicable) from the defective system board and install them on the replacement system board:

- WLAN module (see [WLAN module on page 36](#)).
- Heat sink (see [Heat sink on page 41](#)).

Remove the system board:

1. Disconnect the following cables from the system board:
 - Power connector (DC-in) board cable (1)
 - WLAN antennas from the WLAN module (2)
 - Display cable (ZIF) (3)
 - Audio board cable (ZIF) (4)
 - Speaker cable (5)
 - Keyboard cable (ZIF) (6)
 - Keyboard backlight cable (ZIF) (7) (select products only)
 - Touchpad cable (ZIF) (8)
 - Light bar cable from the light bar (ZIF) (9)
 - Camera cable (10)
 - Fingerprint reader cable (ZIF) (11) (select products only)

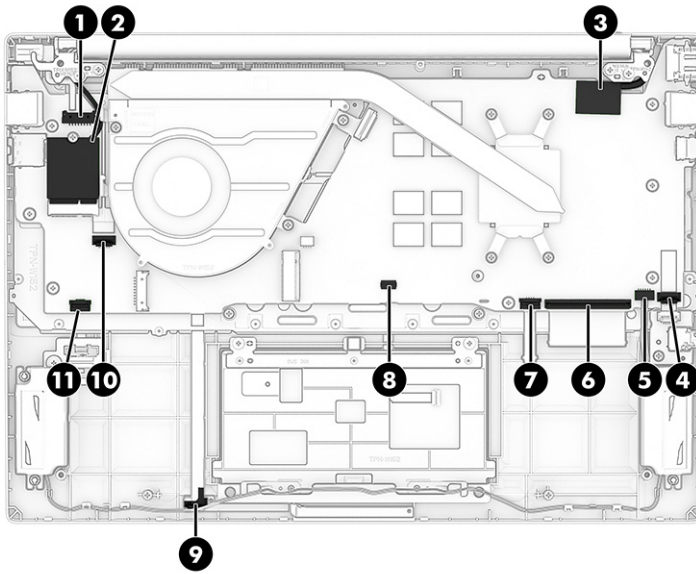

2. Remove the seven Phillips M2.0 × 2.0 screws (1) that secure the system board to the computer.

3. Remove the system board from the computer (2).

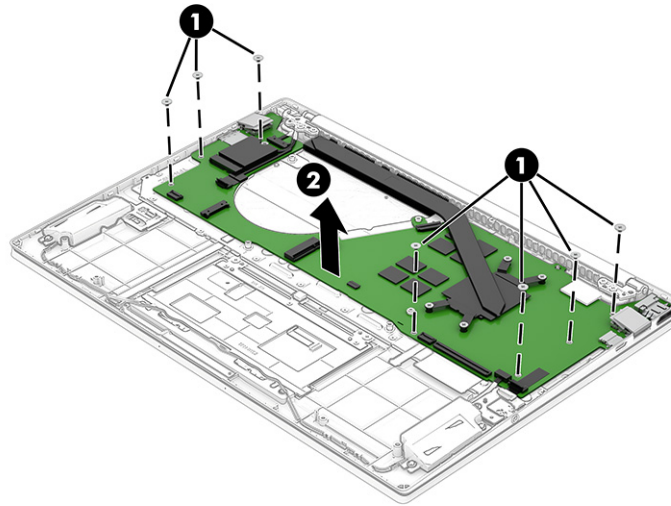

Reverse this procedure to install the system board.

Power connector cable

To remove the power connector cable, use this procedure and illustration.

Table 5-14 Power connector cable description and part number

Description	Spare part number
Power connector cable	M45022-001

Before removing the power connector cable, follow these steps:

1. Prepare the computer for disassembly (see [Preparation for disassembly on page 31](#)).
2. Remove the bottom cover (see [Bottom cover on page 31](#)).
3. Disconnect the battery cable from the system board (see [Battery on page 33](#)).

Remove the power connector cable:

1. Remove the two Phillips M2.5 × 5.0 screws (1) from the right hinge.
2. Rotate the hinge off the power connector (2).
3. Disconnect the power connector cable from the system board (3).

4. Remove the power connector cable from the computer (4).

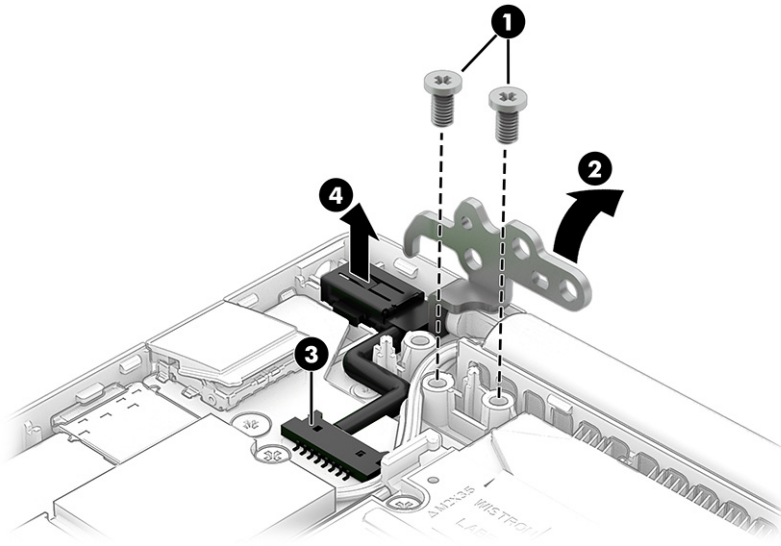

Reverse this procedure to install the power connector cable.

Display assembly

To remove and disassemble the display assembly, use these procedures and illustrations.

 **NOTE:** The display assembly is available as a spare part only at the subcomponent level. For display assembly spare part information, see the individual removal subsections.

Before removing the display panel, follow these steps:

1. Prepare the computer for disassembly (see [Preparation for disassembly on page 31](#)).
2. Remove the bottom cover (see [Bottom cover on page 31](#)).
3. Remove the battery (see [Battery on page 33](#)).
4. Remove the heat sink (see [Heat sink on page 41](#)).

Remove the display assembly:

1. Disconnect the WLAN antenna cables (1) from the terminals on the WLAN module.

 **NOTE:** The WLAN antenna cable labeled 1/MAIN connects to the WLAN module Main terminal. The WLAN antenna cable labeled 2/AUX connects to the WLAN module Aux terminal.

2. Disconnect the camera cable from the system board ZIF connector (2).

3. Disconnect the display cable from the system board ZIF connector (3).

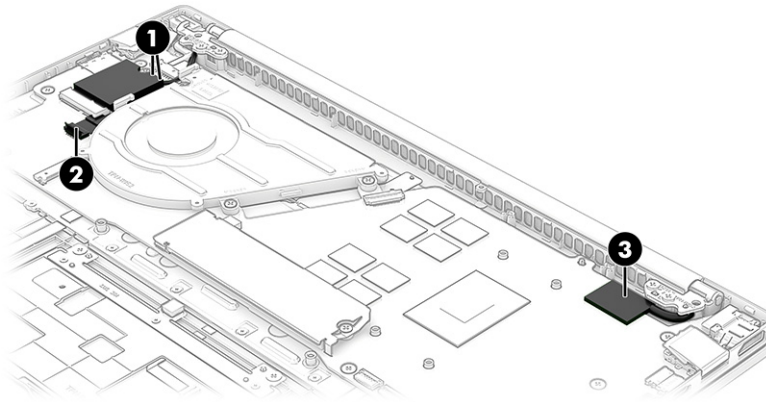

4. Remove the four Phillips M2.5 × 5.0 screws (1) that secure the display assembly to the computer.
5. Open the display to open the hinges (2).
6. Separate the display from the computer (3).

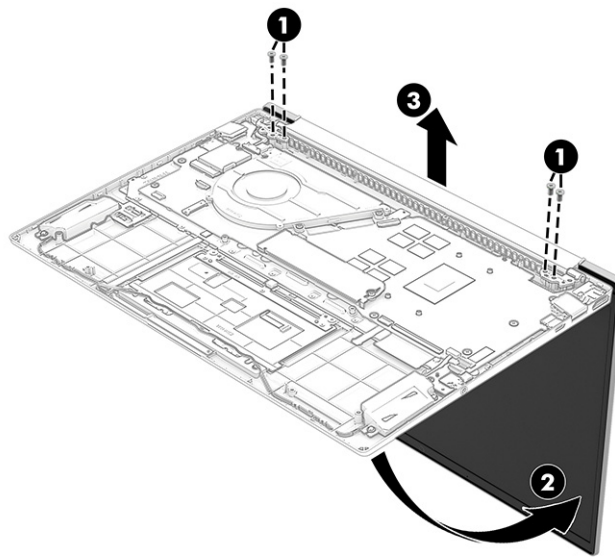

7. If you need to remove the display bezel:
 - a. Use a flat, nonmarking tool to release the top edge of the display bezel (1) from the display assembly.
 - b. Release the left and right edges of the display bezel (2) from the display assembly.
 - c. Release the bottom edge of the display bezel (3) from the display assembly.
 - d. Remove the display bezel (4) from the display assembly.

The bezel is available as the following spare part numbers:

M52785-001: Ceramic white

M52786-001: Natural silver

M52787-001: Pale rose gold

M52788-001: Warm gold

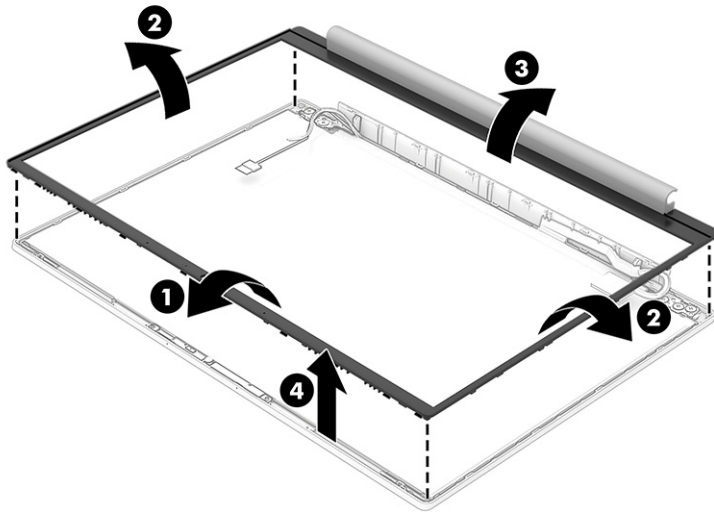

8. If you need to remove the display panel:

- a.** The display panel is secured to the display enclosure with tape that is installed under the left and right sides of the panel. To remove the panel, use tweezers to grasp the end of the tape **(1)**. While turning the tweezers, wrap the tape around the tweezers **(2)** as you continue to pull the tape out from behind the display panel **(3)**. You must pull the tape multiple times before it is completely removed.
- b.** Rotate the display panel over and place it next to the display enclosure **(4)**.



NOTE: Pull the tape out slowly and evenly to prevent it from breaking prematurely.

Display adhesive is available in the Adhesive Kit as spare part number M52817-001.

Display panels are available as the following spare part numbers:

M52803-001: WQXGA

M52804-001: WUXGA

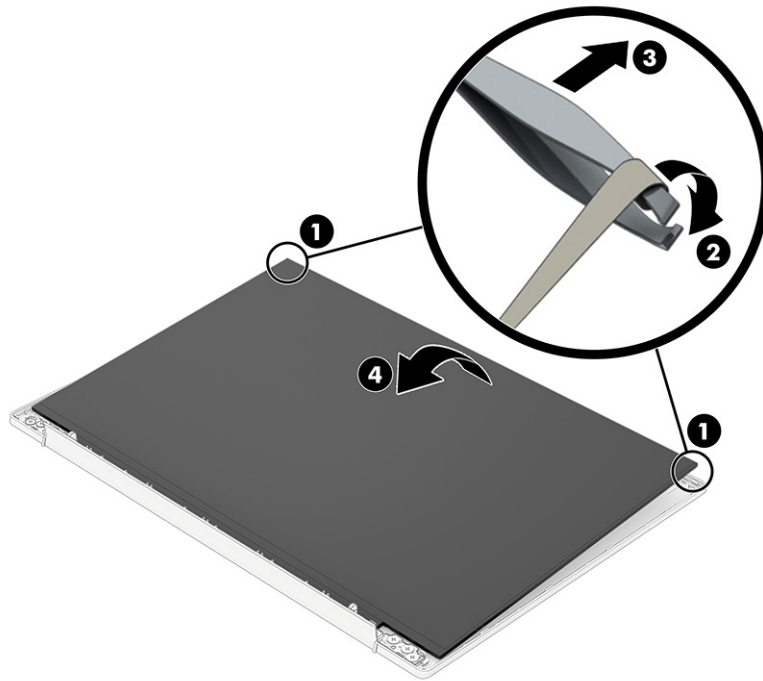

- c. Lift the large, square piece of tape from the display panel connector (1).
- d. Release the adhesive support strip (2) that secures the display panel cable connector to the display panel.
- e. Disconnect the display panel cable (3) from the display panel.

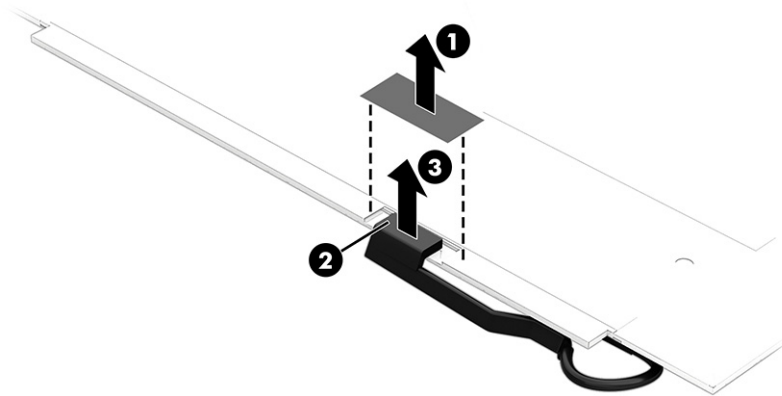

- 9. If you need to remove the hinges from the display rear cover:
 - a. Remove the three Phillips M2.5 × 2.5 screws (1) from the bottom of each hinge.
 - b. Remove the display hinges from the display back cover (2).

The display hinges are available as spare part number M52789-001.

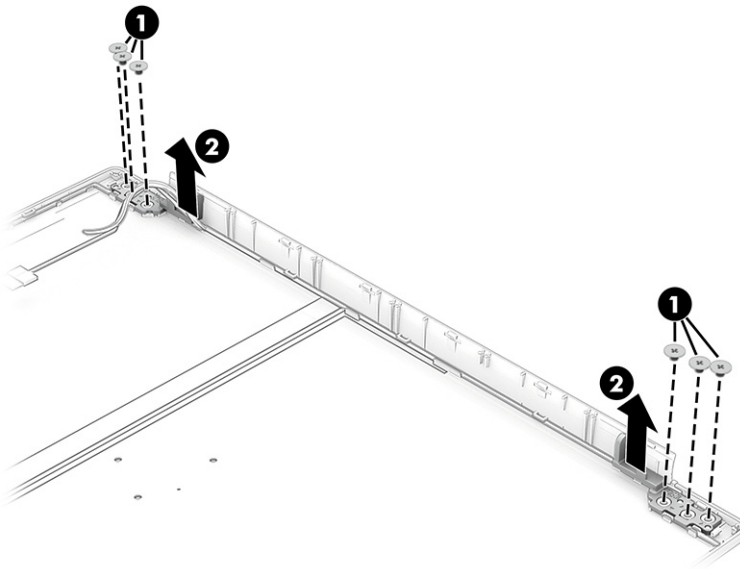

10. If you need to remove the camera module:

- a.** Use a tool to detach the camera module (1) from the display back cover. (The module is attached with double-sided adhesive.)
- b.** Disconnect the cable from the module (2). Note that the cable routes under the module. The camera module is available as spare part number M52835-001.

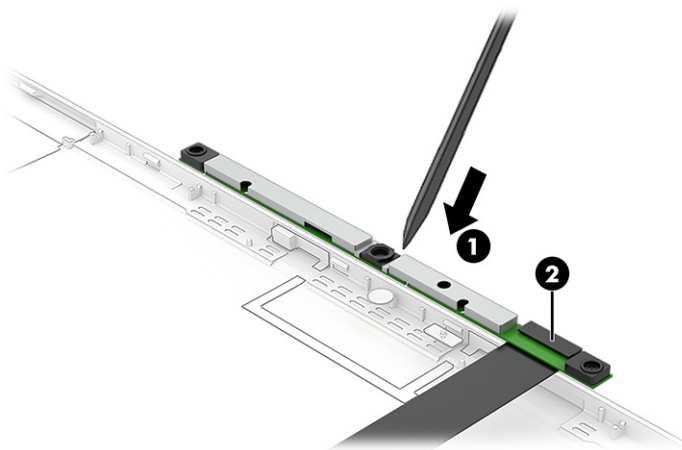

11. If you need to remove the display cable, peel the cable off the inside of the display back cover.

Display cables are available as the following spare part numbers:

M52813-001: WUXGA panels

M52814-001: WQXGA panels

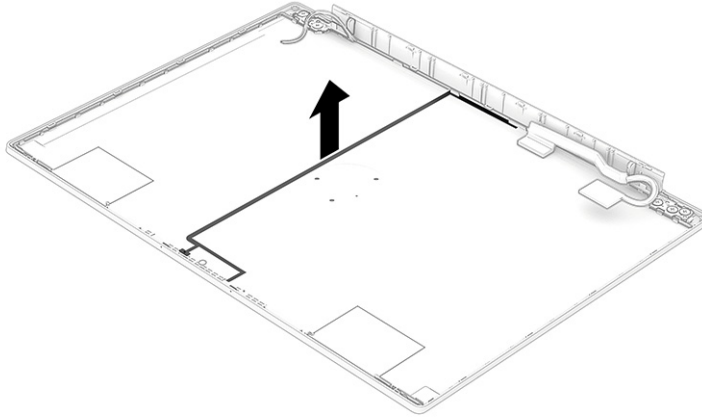

12. If you need to remove the camera cable, peel the cable off the inside of the display back cover. The camera cable is available as spare part number M52809-001.

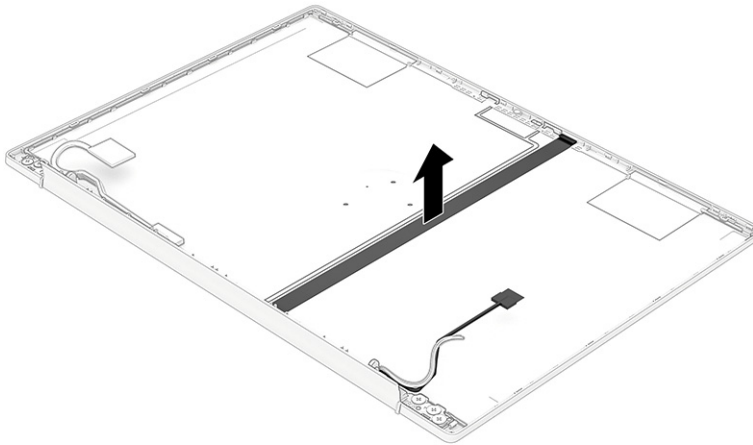

13. Peel the wireless antennas (1) off the display back cover. The antennas are secured with adhesive. Release the wireless antenna cables from the retention clips and routing channels built into the sides and bottom of the display back cover (2). Note that some models have only one antenna.

The wireless cables and antennas are available as spare part number M52780-001 for dual antennas or M52779-001 for single antennas.

Display back covers are available as the following spare part numbers:

M52781-001: Dual antennas, ceramic white

M52782-001: Dual antennas, natural silver

M52783-001: Dual antennas, pale rose gold

M52784-001: Dual antennas, warm gold

M52957-001: Single antenna, ceramic white

M52958-001: Single antenna, natural silver

M52959-001: Single antenna, pale rose gold

M52960-001: Single antenna, warm gold

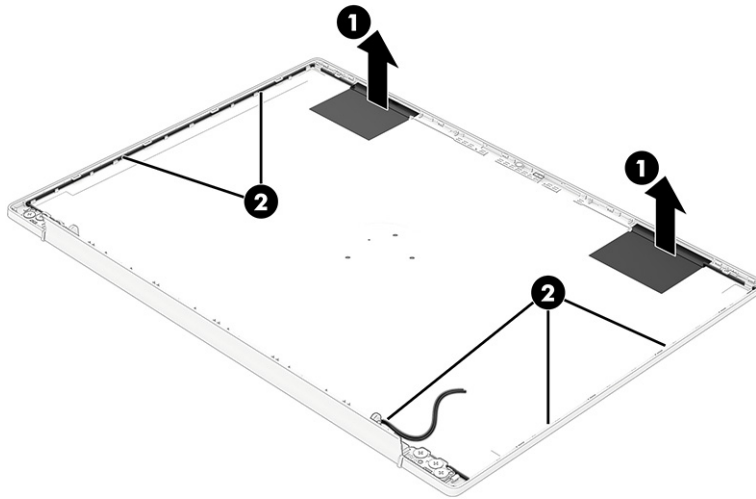

Reverse this procedure to reassemble and replace the display assembly.

Top cover with keyboard

The top cover with keyboard remains after removing all other spare parts from the computer. In this section, the first table provides the main spare part number for the top cover with keyboard. The second table provides the country codes.

Table 5-15 Top cover with keyboard descriptions and part numbers

Description	Spare part number
Top cover with keyboard, not backlit, natural silver	M52829-xx1
Top cover with keyboard, backlit, natural silver	M52830-xx1
Top cover with keyboard, backlit, warm gold	M52831-xx1
Top cover with keyboard, backlit, ceramic white	M52832-xx1
Top cover with keyboard, backlit, pale rose gold	M52833-xx1

Table 5-16 Spare part country codes

For use in country or region	Spare part number	For use in country or region	Spare part number	For use in country or region	Spare part number
Belgium	-A41	Iceland	-DD1	Slovenia	-BA1
Brazil	-201	India	-D61	South Korea	-AD1
Bulgaria	-261	Israel	-BB1	Spain	-071
Chile	-161	Italy	-061	Switzerland	-BG1
Czech Republic/Slovakia	-FL1	Japan	-291	Taiwan	-AB1
Denmark, Finland, and Norway	-DH1	The Netherlands	-B31	Thailand	-281
French Canada	-DB1	Northern Africa	-FP1	Turkey	-141

Table 5-16 Spare part country codes (continued)

For use in country or region	Spare part number	For use in country or region	Spare part number	For use in country or region	Spare part number
France	-051	Portugal	-131	Ukraine	-BD1
Germany	-041	Romania	-271	United Kingdom	-031
Greece	-151	Russia	-251	United States	-001
Hungary	-211	Saudi Arabia	-171		

6 Using Setup Utility (BIOS)

Setup Utility, or Basic Input/Output System (BIOS), controls communication between all the input and output devices on the system (such as disk drives, display, keyboard, mouse, and printer). Setup Utility (BIOS) includes settings for the types of devices installed, the startup sequence of the computer, and the amount of system and extended memory.

 **NOTE:** To start Setup Utility on convertible computers, your computer must be in notebook mode and you must use the keyboard attached to your notebook.

Starting Setup Utility (BIOS)

You have several ways to access the Setup Utility (BIOS).

 **IMPORTANT:** Use extreme care when making changes in Setup Utility (BIOS). Errors can prevent the computer from operating properly.

- Turn on or restart the computer and quickly press **f10**.

– or –

Turn on or restart the computer, quickly press **esc**, and then press **f10** when the Start menu is displayed.

Updating Setup Utility (BIOS)

Updated versions of Setup Utility (BIOS) might be available on the HP website. Most BIOS updates on the HP website are packaged in compressed files called *SoftPaqs*. Some download packages contain a file named *Readme.txt*, which contains information regarding installing and troubleshooting the file.

Determining the BIOS version

To decide whether you need to update Setup Utility (BIOS), first determine the BIOS version on your computer.

To reveal the BIOS version information (also known as *ROM date* and *System BIOS*), use one of these options.

- HP Support Assistant
 1. Type `support` in the taskbar search box, and then select the **HP Support Assistant** app.

– or –

Select the question mark icon in the taskbar.
 2. Select **My notebook**, and then select **Specifications**.
- Setup Utility (BIOS)
 1. Start Setup Utility (BIOS) (see [Starting Setup Utility \(BIOS\) on page 56](#)).
 2. Select **Main**, and then make note of the BIOS version.
 3. Select **Exit**, select one of the options, and then follow the on-screen instructions.

- In Windows, press **ctrl+alt+s**.

To check for later BIOS versions, see [Preparing for a BIOS update on page 57](#).

Preparing for a BIOS update

Be sure to follow all prerequisites before downloading and installing a BIOS update.



IMPORTANT: To reduce the risk of damage to the computer or an unsuccessful installation, download and install a BIOS update only when the computer is connected to reliable external power using the AC adapter. Do not download or install a BIOS update while the computer is running on battery power, docked in an optional docking device, or connected to an optional power source. During the download and installation, follow these instructions:

- Do not disconnect power from the computer by unplugging the power cord from the AC outlet.
- Do not shut down the computer or initiate Sleep.
- Do not insert, remove, connect, or disconnect any device, cable, or cord.



NOTE: If your computer is connected to a network, consult the network administrator before installing any software updates, especially system BIOS updates.

Downloading a BIOS update

After you review the prerequisites, you can check for and download BIOS updates.

1. Type `support` in the taskbar search box, and then select the **HP Support Assistant** app.
– or –
Select the question mark icon in the taskbar.
2. Select **Updates**, and then select **Check for updates and messages**.
3. Follow the on-screen instructions.
4. At the download area, follow these steps:
 - a. Identify the most recent BIOS update and compare it to the BIOS version currently installed on your computer. If the update is more recent than your BIOS version, make a note of the date, name, or other identifier. You might need this information to locate the update later, after it has been downloaded to your hard drive.
 - b. Follow the on-screen instructions to download your selection to the hard drive.

Make a note of the path to the location on your hard drive where the BIOS update is downloaded. You will need to access this path when you are ready to install the update.

Installing a BIOS update

BIOS installation procedures vary. Follow any instructions that appear on the screen after the download is complete. If no instructions appear, follow these steps.

1. Type `file` in the taskbar search box, and then select **File Explorer**.
2. Select your hard drive designation. The hard drive designation is typically Local Disk (C:).
3. Using the hard drive path you recorded earlier, open the folder that contains the update.

4. Double-click the file that has an .exe extension (for example, *filename.exe*).
The BIOS installation begins.
5. Complete the installation by following the on-screen instructions.



NOTE: After a message on the screen reports a successful installation, you can delete the downloaded file from your hard drive.

7 Backing up, restoring, and recovering

You can use Windows tools or HP software to back up your information, create a restore point, reset your computer, create recovery media, or restore your computer to its factory state. Performing these standard procedures can return your computer to a working state faster.

 **IMPORTANT:** If you are performing recovery procedures on a tablet, the tablet battery must be at least 70% charged before you start the recovery process.

 **IMPORTANT:** For a tablet with a detachable keyboard, connect the tablet to the keyboard base before beginning any recovery process.

Backing up information and creating recovery media

These methods of creating recovery media and backups are available on select products only.

Using Windows tools for backing up

HP recommends that you back up your information immediately after initial setup. You can do this task either using Windows Backup locally with an external USB drive or using online tools.

 **IMPORTANT:** Windows is the only option that allows you to back up your personal information. Schedule regular backups to avoid information loss.

 **NOTE:** If computer storage is 32 GB or less, Microsoft® System Restore is disabled by default.

Using the HP Cloud Recovery Download Tool to create recovery media (select products only)

You can use the HP Cloud Recovery Download Tool to create HP Recovery media on a bootable USB flash drive.

For details:

- Go to <http://www.hp.com>, search for HP Cloud Recovery, and then select the result that matches the type of computer that you have.

 **NOTE:** If you cannot create recovery media yourself, contact support to obtain recovery discs. Go to <http://www.hp.com/support>, select your country or region, and then follow the on-screen instructions.

 **IMPORTANT:** HP recommends that you follow the [Restoring and recovery methods on page 60](#) to restore your computer before you obtain and use the HP recovery discs. Using a recent backup can return your machine to a working state sooner than using the HP recovery discs. After the system is restored, reinstalling all the operating system software released since your initial purchase can be a lengthy process.

Restoring and recovering your system

You have several tools available to recover your system both within and outside of Windows if the desktop cannot load.

HP recommends that you attempt to restore your system using the [Restoring and recovery methods on page 60](#).

Creating a system restore

System Restore is available in Windows. The System Restore software can automatically or manually create restore points, or snapshots, of the system files and settings on the computer at a particular point.

When you use System Restore, it returns your computer to its state at the time you made the restore point. Your personal files and documents should not be affected.

Restoring and recovery methods

After you run the first method, test to see whether the issue still exists before you proceed to the next method, which might now be unnecessary.

1. Run a Microsoft System Restore.
2. Run Reset this PC.



NOTE: The options **Remove everything** and then **Fully clean the drive** can take several hours to complete and leave no information on your computer. It is the safest way to reset your computer before you recycle it.

3. Recover using HP Recovery media. For more information, see [Recovering using HP Recovery media on page 60](#).

For more information about the first two methods, see the Get Help app:

Select the **Start** button, select the **Get Help** app, and then enter the task you want to perform.



NOTE: You must be connected to the internet to access the Get Help app.

Recovering using HP Recovery media

You can use HP Recovery media to recover the original operating system and software programs that were installed at the factory. On select products, it can be created on a bootable USB flash drive using the HP Cloud Recovery Download Tool.

For details, see [Using the HP Cloud Recovery Download Tool to create recovery media \(select products only\) on page 59](#).



NOTE: If you cannot create recovery media yourself, contact support to obtain recovery discs. Go to <http://www.hp.com/support>, select your country or region, and then follow the on-screen instructions.

To recover your system:

- Insert the HP Recovery media, and then restart the computer.



NOTE: HP recommends that you follow the [Restoring and recovery methods on page 60](#) to restore your computer before you obtain and use the HP recovery discs. Using a recent backup can return your machine to a working state sooner than using the HP recovery discs. After the system is restored, reinstalling all the operating system software released since your initial purchase can be a lengthy process.

Changing the computer boot order

If your computer does not restart using the HP Recovery media, you can change the computer boot order, which is the order of devices listed in BIOS for startup information. You can select an optical drive or a USB flash drive, depending on the location of your HP Recovery media.

 **IMPORTANT:** For a tablet with a detachable keyboard, connect the tablet to the keyboard base before beginning these steps.

To change the boot order:

1. Insert the HP Recovery media.
2. Access the system **Startup** menu.
 - For computers or tablets with keyboards attached, turn on or restart the computer or tablet, quickly press **esc**, and then press **f9** for boot options.
 - For tablets without keyboards, turn on or restart the tablet, quickly press and hold the volume up button, and then select **f9**.

– or –

Turn on or restart the tablet, quickly press and hold the volume down button, and then select **f9**.
3. Select the optical drive or USB flash drive from which you want to boot, and then follow the on-screen instructions.

Using HP Sure Recover (select products only)

Select computer models are configured with HP Sure Recover, a PC operating system (OS) recovery solution built into the hardware and software. HP Sure Recover can fully restore the HP OS image without installed recovery software.

Using HP Sure Recover, an administrator or user can restore the system and install:

- Latest version of the operating system
- Platform-specific device drivers
- Software applications, in the case of a custom image

To access the latest documentation for HP Sure Recover, go to <http://www.hp.com/support>. Follow the on-screen instructions to find your product and locate your documentation.

8 Using HP PC Hardware Diagnostics

You can use the HP PC Hardware Diagnostics utility to determine whether your computer hardware is running properly. The three versions are HP PC Hardware Diagnostics Windows, HP PC Hardware Diagnostics UEFI (Unified Extensible Firmware Interface), and (for select products only) Remote HP PC Hardware Diagnostics UEFI, a firmware feature.

Using HP PC Hardware Diagnostics Windows (select products only)

HP PC Hardware Diagnostics Windows is a Windows-based utility that allows you to run diagnostic tests to determine whether the computer hardware is functioning properly. The tool runs within the Windows operating system to diagnose hardware failures.

If HP PC Hardware Diagnostics Windows is not installed on your computer, you must download and install it. To download HP PC Hardware Diagnostics Windows, see [Downloading HP PC Hardware Diagnostics Windows on page 63](#).

Using an HP PC Hardware Diagnostics Windows hardware failure ID code

When HP PC Hardware Diagnostics Windows detects a failure that requires hardware replacement, a 24-digit failure ID code is generated for select component tests. For interactive tests, such as keyboard, mouse, or audio and video palette, you must perform troubleshooting steps before you can receive a failure ID.

- You have several options after you receive a failure ID:
 - Select **Next** to open the Event Automation Service (EAS) page, where you can log the case.
 - Scan the QR code with your mobile device, which takes you to the EAS page, where you can log the case.
 - Select the box next to the 24-digit failure ID to copy your failure code and send it to support.

Accessing HP PC Hardware Diagnostics Windows

After HP PC Hardware Diagnostics Windows is installed, you can access it from HP Support Assistant or the Start menu.

Accessing HP PC Hardware Diagnostics Windows from HP Help and Support (select products only)

After HP PC Hardware Diagnostics Windows is installed, follow these steps to access it from HP Help and Support.

1. Select the **Start** button, and then select **HP Help and Support**.
2. Select **HP PC Hardware Diagnostics Windows**.
3. When the tool opens, select the type of diagnostic test that you want to run, and then follow the on-screen instructions.



NOTE: To stop a diagnostic test, select **Cancel**.

Accessing HP PC Hardware Diagnostics Windows from Support Assistant

After HP PC Hardware Diagnostics Windows is installed, follow these steps to access it from HP Support Assistant.

1. Type `support` in the taskbar search box, and then select the **HP Support Assistant** app.
– or –
Select the question mark icon in the taskbar.
2. Select **Troubleshooting and fixes**.
3. Select **Diagnostics**, and then select **HP PC Hardware Diagnostics Windows**.
4. When the tool opens, select the type of diagnostic test that you want to run, and then follow the on-screen instructions.

 **NOTE:** To stop a diagnostic test, select **Cancel**.

Accessing HP PC Hardware Diagnostics Windows from the Start menu (select products only)

After HP PC Hardware Diagnostics Windows is installed, follow these steps to access it from the Start menu.

1. Select the **Start** button.
2. Right-click **HP PC Hardware Diagnostics for Windows**, select **More**, and then select **Run as administrator**.
3. When the tool opens, select the type of diagnostic test that you want to run, and then follow the on-screen instructions.

 **NOTE:** To stop a diagnostic test, select **Cancel**.

Downloading HP PC Hardware Diagnostics Windows

The HP PC Hardware Diagnostics Windows downloading instructions are provided in English only. You must use a Windows computer to download this tool because only .exe files are provided.

Downloading the latest HP PC Hardware Diagnostics Windows version from HP

To download HP PC Hardware Diagnostics Windows from HP, follow these steps:

1. Go to <http://www.hp.com/go/techcenter/pcdiags>. The HP PC Diagnostics home page is displayed.
2. Select **Download HP Diagnostics Windows**, and then select the specific Windows diagnostics version to download to your computer or a USB flash drive.

The tool downloads to the selected location.

Downloading the HP PC Hardware Diagnostics Windows from the Microsoft Store

You can download the HP PC Hardware Diagnostics Windows from the Microsoft Store.

1. Select the Microsoft Store app on your desktop or enter `Microsoft Store` in the taskbar search box.
2. Enter `HP PC Hardware Diagnostics Windows` in the **Microsoft Store** search box.
3. Follow the on-screen directions.

The tool downloads to the selected location.

Downloading HP Hardware Diagnostics Windows by product name or number (select products only)

You can download HP PC Hardware Diagnostics Windows by product name or number.

 **NOTE:** For some products, you might have to download the software to a USB flash drive by using the product name or number.

1. Go to <http://www.hp.com/support>.
2. Select **Software and Drivers**, select your type of product, and then enter the product name or number in the search box that is displayed.
3. In the **Diagnostics** section, select **Download**, and then follow the on-screen instructions to select the specific Windows diagnostics version to be downloaded to your computer or USB flash drive.

The tool downloads to the selected location.

Installing HP PC Hardware Diagnostics Windows

To install HP PC Hardware Diagnostics Windows, navigate to the folder on your computer or the USB flash drive where the .exe file downloaded, double-click the .exe file, and then follow the on-screen instructions.

Using HP PC Hardware Diagnostics UEFI

HP PC Hardware Diagnostics UEFI (Unified Extensible Firmware Interface) allows you to run diagnostic tests to determine whether the computer hardware is functioning properly. The tool runs outside the operating system so that it can isolate hardware failures from issues that are caused by the operating system or other software components.

 **NOTE:** For Windows 10 S computers, you must use a Windows computer and a USB flash drive to download and create the HP UEFI support environment because only .exe files are provided. For more information, see [Downloading HP PC Hardware Diagnostics UEFI to a USB flash drive on page 65](#).

If your PC does not start in Windows, you can use HP PC Hardware Diagnostics UEFI to diagnose hardware issues.

Using an HP PC Hardware Diagnostics UEFI hardware failure ID code

When HP PC Hardware Diagnostics UEFI detects a failure that requires hardware replacement, a 24-digit failure ID code is generated.

For assistance in solving the problem:

- Select **Contact HP**, accept the HP privacy disclaimer, and then use a mobile device to scan the failure ID code that appears on the next screen. The HP Customer Support - Service Center page appears with your failure ID and product number automatically filled in. Follow the on-screen instructions.

– or –

Contact support, and provide the failure ID code.

 **NOTE:** To start diagnostics on a convertible computer, your computer must be in notebook mode, and you must use the attached keyboard.

 **NOTE:** If you need to stop a diagnostic test, press **esc**.

Starting HP PC Hardware Diagnostics UEFI

To start HP PC Hardware Diagnostics UEFI, follow this procedure.

1. Turn on or restart the computer, and quickly press **esc**.
2. Press **f2**.

The BIOS searches three places for the diagnostic tools, in the following order:

- a. Connected USB flash drive



NOTE: To download the HP PC Hardware Diagnostics UEFI tool to a USB flash drive, see [Downloading the latest HP PC Hardware Diagnostics UEFI version on page 65](#).

- b. Hard drive

- c. BIOS

3. When the diagnostic tool opens, select a language, select the type of diagnostic test you want to run, and then follow the on-screen instructions.

Downloading HP PC Hardware Diagnostics UEFI to a USB flash drive

Downloading HP PC Hardware Diagnostics UEFI to a USB flash drive can be useful in some situations.

- HP PC Hardware Diagnostics UEFI is not included in the preinstallation image.
- HP PC Hardware Diagnostics UEFI is not included in the HP Tool partition.
- The hard drive is damaged.



NOTE: The HP PC Hardware Diagnostics UEFI downloading instructions are provided in English only, and you must use a Windows computer to download and create the HP UEFI support environment because only .exe files are provided.

Downloading the latest HP PC Hardware Diagnostics UEFI version

To download the latest HP PC Hardware Diagnostics UEFI version to a USB flash drive, follow this procedure:

1. Go to <http://www.hp.com/go/techcenter/pcdiags>. The HP PC Diagnostics home page is displayed.
2. Select **Download HP Diagnostics UEFI**, and then select **Run**.

Downloading HP PC Hardware Diagnostics UEFI by product name or number (select products only)

You can download HP PC Hardware Diagnostics UEFI by product name or number (select products only) to a USB flash drive.



NOTE: For some products, you might have to download the software to a USB flash drive by using the product name or number.

1. Go to <http://www.hp.com/support>.
2. Enter the product name or number, select your computer, and then select your operating system.
3. In the **Diagnostics** section, follow the on-screen instructions to select and download the specific UEFI Diagnostics version for your computer.

Using Remote HP PC Hardware Diagnostics UEFI settings (select products only)

Remote HP PC Hardware Diagnostics UEFI is a firmware (BIOS) feature that downloads HP PC Hardware Diagnostics UEFI to your computer. It can then run the diagnostics on your computer, and it might upload results to a preconfigured server.

For more information about Remote HP PC Hardware Diagnostics UEFI, go to <http://www.hp.com/go/techcenter/pcdiags>, and then select **Find out more**.

Downloading Remote HP PC Hardware Diagnostics UEFI

Remote HP PC Hardware Diagnostics UEFI is also available as a SoftPaq that you can download to a server.

Downloading the latest Remote HP PC Hardware Diagnostics UEFI version

You can download the latest Remote HP PC Hardware Diagnostics UEFI version to a USB flash drive.

1. Go to <http://www.hp.com/go/techcenter/pcdiags>. The HP PC Diagnostics home page is displayed.
2. Select **Download Remote Diagnostics**, and then select **Run**.

Downloading Remote HP PC Hardware Diagnostics UEFI by product name or number

You can download Remote HP PC Hardware Diagnostics UEFI by product name or number.



NOTE: For some products, you might have to download the software by using the product name or number.

1. Go to <http://www.hp.com/support>.
2. Select **Software and Drivers**, select your type of product, enter the product name or number in the search box that is displayed, select your computer, and then select your operating system.
3. In the **Diagnostics** section, follow the on-screen instructions to select and download the **Remote UEFI** version for the product.

Customizing Remote HP PC Hardware Diagnostics UEFI settings

Using the Remote HP PC Hardware Diagnostics setting in Computer Setup (BIOS), you can perform several customizations.

- Set a schedule for running diagnostics unattended. You can also start diagnostics immediately in interactive mode by selecting **Execute Remote HP PC Hardware Diagnostics**.
- Set the location for downloading the diagnostic tools. This feature provides access to the tools from the HP website or from a server that has been preconfigured for use. Your computer does not require the traditional local storage (such as a hard drive or USB flash drive) to run remote diagnostics.
- Set a location for storing the test results. You can also set the user name and password that you use for uploads.
- Display status information about the diagnostics run previously.

To customize Remote HP PC Hardware Diagnostics UEFI settings, follow these steps:

1. Turn on or restart the computer, and when the HP logo appears, press **f10** to enter Computer Setup.

2. Select **Advanced**, and then select **Settings**.
3. Make your customization selections.
4. Select **Main**, and then **Save Changes and Exit** to save your settings.

Your changes take effect when the computer restarts.

9 Specifications

This chapter provides specifications for your computer system.

Computer specifications

This section provides specifications for your computer. When traveling with your computer, the computer dimensions and weights, as well as input power ratings and operating specifications, provide helpful information.

Table 9-1 Computer specifications

	Metric	U.S.
Dimensions		
Width	297.6 mm	11.7 in
Depth	209.0 mm	8.20 in
Height (front to back)	16.9 mm	0.67 in
Weight		
	998 g	2.20 lb
Input power		
Operating voltage and current	19.5 V dc @ 3.33 A – 65 W	
	19.5 V dc @ 2.31 A – 45 W	
Temperature		
Operating	5°C to 35°C	41°F to 95°F
Nonoperating	–20°C to 60°C	–4°F to 140°F
Relative humidity (noncondensing)		
Operating	10% to 90%	
Nonoperating	5% to 95%	
Maximum altitude (unpressurized)		
Operating	–15 m to 3,048 m	–50 ft to 10,000 ft
Nonoperating	–15 m to 12,192 m	–50 ft to 40,000 ft
NOTE: Applicable product safety standards specify thermal limits for plastic surfaces. The device operates well within this range of temperatures.		

33.8 cm (13.3 in) display specifications

This section provides specifications for your display.

Table 9-2 Display specifications

	Metric	U.S.
Active diagonal size	33.8 cm	13.3 in
Resolution	2560 × 1600 (WQXGA) 1920 × 1200 (WUXGA)	
Surface treatment	Antiglare	
Brightness	400 nits	
Viewing angle	UWVA	
Backlight	WLED	
Display panel interface	eDP 1.4 + PSR2	

Solid-state drive specifications

This section provides specifications for your solid-state drives.

Table 9-3 Solid-state drive specifications

	256 GB*	512 GB*	1 TB*
Dimensions			
Height	1.0 mm	1.0 mm	1.0 mm
Length	50.8 mm	50.8 mm	50.8 mm
Width	28.9 mm	28.9 mm	28.9 mm
Weight	< 10 g	< 10 g	< 10 g
Interface type			
Ready time, maximum (to not busy)	1.0 ms	< 1.0 ms	1.0 ms
Access times, logical	0.1 ms	0.1 ms	0.1 ms
Transfer rate			
Sequential read	up to 2150 MB/s	up to 2150 MB/s	up to 2150 MB/s
Random read	Up to 300,000 IOPs	Up to 300,000 IOPs	Up to 300,000 IOPs
Sequential write	up to 1550 MB/s	up to 1550 MB/s	up to 1550 MB/s
Random write	Up to 100,000 IOPs	Up to 100,000 IOPs	Up to 100,000 IOPs
Total logical sectors	468,883,296	1,000,215,216	1,500,336,388
Operating temperature	0°C to 70°C (32°F to 158°F)		

*1 GB = 1 billion bytes when referring to hard drive storage capacity. Actual accessible capacity is less. Actual drive specifications might differ slightly.

NOTE: Certain restrictions and exclusions apply. Contact support for details.

10 Power cord set requirements

This chapter provides power cord requirements for countries and regions.

The wide-range input feature of the computer permits it to operate from any line voltage from 100 V AC to 120 V AC, or from 220 V AC to 240 V AC.

The three-conductor power cord set included with the computer meets the requirements for use in the country or region where the equipment is purchased.

Power cord sets for use in other countries or regions must meet the requirements of the country and region where the computer is used.

Requirements for all countries

These power cord requirements are applicable to all countries and regions.

- The length of the power cord set must be at least **1.0 m** (3.3 ft) and no more than **2.0 m** (6.5 ft).
- All power cord sets must be approved by an acceptable accredited agency responsible for evaluation in the country or region where the power cord set will be used.
- The power cord sets must have a minimum current capacity of 10 A and a nominal voltage rating of 125 V AC or 250 V AC, as required by the power system of each country or region.
- The appliance coupler must meet the mechanical configuration of an EN 60 320/IEC 320 Standard Sheet C13 connector for mating with the appliance inlet on the back of the computer.

Requirements for specific countries and regions

To determine power cord requirements for specific countries and regions, use this table.

Table 10-1 Power cord requirements for specific countries and regions

Country/region	Accredited agency	Applicable note number
Argentina	IRAM	1
Australia	SAA	1
Austria	OVE	1
Belgium	CEBEC	1
Brazil	ABNT	1
Canada	CSA	2
Chile	IMQ	1
Denmark	DEMKO	1
Finland	FIMKO	1
France	UTE	1
Germany	VDE	1

Table 10-1 Power cord requirements for specific countries and regions (continued)

Country/region	Accredited agency	Applicable note number
India	BIS	1
Israel	SII	1
Italy	IMQ	1
Japan	JIS	3
Netherlands	KEMA	1
New Zealand	SANZ	1
Norway	NEMKO	1
People's Republic of China	CCC	4
Saudi Arabia	SASO	7
Singapore	PSB	1
South Africa	SABS	1
South Korea	KTL	5
Sweden	SEMKO	1
Switzerland	SEV	1
Taiwan	BSMI	6
Thailand	TISI	1
United Kingdom	ASTA	1
United States	UL	2

1. The flexible cord must be Type H05VV-F, three-conductor, 0.75 mm² conductor size. Power cord set fittings (appliance coupler and wall plug) must bear the certification mark of the agency responsible for evaluation in the country or region where it will be used.
2. The flexible cord must be Type SVT/SJT or equivalent, No. 18 AWG, three-conductor. The wall plug must be a two-pole grounding type with a NEMA 5-15P (15 A, 125 V AC) or NEMA 6-15P (15 A, 250 V AC) configuration. CSA or C-UL mark. UL file number must be on each element.
3. The appliance coupler, flexible cord, and wall plug must bear a T mark and registration number in accordance with the Japanese Dentori Law. The flexible cord must be Type VCTF, three-conductor, 0.75 mm² or 1.25 mm² conductor size. The wall plug must be a two-pole grounding type with a Japanese Industrial Standard C8303 (7 A, 125 V AC) configuration.
4. The flexible cord must be Type RVV, three-conductor, 0.75 mm² conductor size. Power cord set fittings (appliance coupler and wall plug) must bear the CCC certification mark.
5. The flexible cord must be Type H05VV-F three-conductor, 0.75 mm² conductor size. KTL logo and individual approval number must be on each element. Approval number and logo must be printed on a flag label.
6. The flexible cord must be Type HVCTF three-conductor, 1.25 mm² conductor size. Power cord set fittings (appliance coupler, cable, and wall plug) must bear the BSMI certification mark.
7. For 127 V AC, the flexible cord must be Type SVT or SJT 3-conductor, 18 AWG, with plug NEMA 5-15P (15 A, 125 V AC), with UL and CSA or C-UL marks. For 240 V AC, the flexible cord must be Type H05VV-F three-conductor, 0.75 mm² or 1.00 mm² conductor size, with plug BS 1363/A with BSI or ASTA marks.

11 Recycling

When a nonrechargeable or rechargeable battery has reached the end of its useful life, do not dispose of the battery in general household waste. Follow the local laws and regulations in your area for battery disposal.

HP encourages customers to recycle used electronic hardware, HP original print cartridges, and rechargeable batteries. For more information about recycling programs, see the HP website at <http://www.hp.com/recycle>.

Index

A

- AC adapter and battery light, identifying 5
- AC adapters, spare part numbers 20
- action key, identifying 12
- audio board
 - illustrated 16
 - removal 43
 - spare part number 16
 - spare part numbers 43
- audio-out (headphone)/audio-in (microphone) combo jack, identifying 6
- audio, product description 2

B

- backup, creating 59
- backups 59
- battery
 - illustrated 16
 - spare part number 16
- BIOS
 - determining version 56
 - downloading an update 57
 - starting the Setup Utility 56
 - updating 56
- Bluetooth label 13
- boot order, changing 61
- bottom components 12
- bottom cover
 - illustrated 17
 - removal 31
 - rubber feet
 - removal 31
 - spare part number 31
 - spare part number 17, 31
- buttons
 - left touchpad 8
 - power 11
 - right touchpad 8

C

- cables
 - spare part numbers 19
- camera
 - identifying 7

- illustrated 19
 - spare part number 19
- camera light, identifying 7
- caps lock light 9
- caring for your computer 26
- cautions
 - electrostatic discharge 22, 23
- cleaning your computer 26
 - caring for wood veneer 28
 - disinfecting 27
 - HP Easy Clean 26
 - removing dirt and debris 26
- components
 - bottom 12
 - display 6
 - keyboard area 7
 - left side 5
 - lights 9
 - right side 4
 - touchpad 8
- computer major components 15
- computer specifications 68
- connectors
 - power 5
- control zone 8

D

- display
 - specifications 68
- display assembly
 - subcomponents 17
- display back cover
 - illustrated 19
 - spare part number 19
- display bezel
 - illustrated 18
 - spare part number 18
- display cable
 - illustrated 19
 - spare part number 19
- display components 6
- display panel
 - illustrated 18
 - product description 1
 - spare part number 18
- display/camera cable
 - spare part number 19

E

- electrostatic discharge (ESD) 22, 23
 - preventing damage 22-24
- esc key, identifying 12

F

- fan
 - illustrated 16
 - removal 40
 - spare part number 16, 40
- fingerprint reader 11
 - illustrated 17
 - removal 39
 - spare part number 17
 - spare part numbers 39
- fingerprint reader cable
 - spare part number 19
- fn key, identifying 12

G

- graphics, product description 1
- grounding methods 22-24
- guidelines
 - packaging 22, 28
 - transporting 22, 28
 - workstation 22

H

- hard drive
 - product description 1
 - specifications 68
- HDMI port
 - identifying 5
- heat sink
 - illustrated 17
 - removal 41
 - spare part number 17, 41
- hinge
 - illustrated 19
 - spare part number 19
- HP PC Hardware Diagnostics UEFI
 - downloading 65
 - failure ID code 64
 - starting 65
 - using 64

HP PC Hardware Diagnostics

Windows

- accessing 62, 63
- downloading 63
- failure ID code 62
- installing 64
- using 62

HP Recovery media

- recovery 60

HP Sure Recover 61

I

illustrated parts catalog 15

internal microphones, identifying 7

J

jacks

- audio-out (headphone)/audio-in (microphone) 6

K

keyboard

- product description 2

keyboard with top cover

- spare part numbers 54

keys

- action 12
- esc 12
- fn 12
- Windows 12

L

labels

- Bluetooth 13
- regulatory 13
- serial number 13
- service 13
- wireless certification 13
- WLAN 13

left control zone, identifying 8

left side components 5

light bar

- removal 42
- spare part numbers 42

lights

- AC adapter and battery 5
- camera 7
- caps lock 9
- mute 9
- power 9
- touchpad 8

low blue light mode 6

M

memory module

- product description 1

microphone

- product description 2

miscellaneous parts 20

model name 1

mute light, identifying 9

O

operating system, product

- description 3

P

packaging guidelines 22, 28

pointing device, product

- description 2

ports

- HDMI 5
- product description 2
- USB SuperSpeed 4, 5
- USB Type-C DisplayPort 6
- USB Type-C power connector 6
- USB Type-C SuperSpeed 6

power button, identifying 11

power connector

- identifying 5

power connector cable

- illustrated 17
- removal 47
- spare part number 17
- spare part numbers 47

power connector cable cable

- spare part number 19

power cord

- requirements for all countries 70
- requirements for specific countries and regions 70
- set requirements 70

power cords, spare part

- numbers 20

power light, identifying 9

power requirements, product

- description 3

primary storage

- product description 1

processor

- product description 1

product description

- audio 2
- display panel 1
- graphics 1

hard drive 1

keyboard 2

memory module 1

microphone 2

operating system 3

pointing device 2

ports 2

power requirements 3

primary storage 1

processors 1

product name 1

security 3

serviceability 3

solid-state drive 1

video 2

wireless 2

product name 1

product name and number,

computer 13

R

recovery 59

discs 60

media 60

USB flash drive 60

recovery media 59

creating using HP Cloud Recovery

Download Tool 59

creating using Windows

tools 59

regulatory information

regulatory label 13

wireless certification labels 13

Remote HP PC Hardware Diagnostics

UEFI settings

customizing 66

using 66

removal and replacement

procedures 31

solid-state drive 34

restoring 59

restoring and recovery methods 60

right control zone, identifying 8

right side components 4

Rubber Foot Kit

illustrated 17

spare part number 17

S

Screw Kit, spare part number 20

security, product description 3

serial number, computer 13

service labels, locating 13

- serviceability, product
 - description 3
- SIM slot, identifying 4
- slots
 - SIM card 4
- solid-state drive
 - illustrated 17
 - product description 1
 - removal and replacement 34
 - spare part number 17
 - specifications 69
- spare part country codes 54
- speaker
 - illustrated 16
 - removal 35
 - spare part number 16
 - spare part numbers 35
- speakers 12
- special keys
 - identifying 11
 - using 11
- specifications
 - computer 68
 - display 68
 - hard drive 68
 - solid-state drive 69
- static electricity 22, 23
- support information 28
- system board
 - removal 45
 - spare part numbers 45
- system restore 60
- system restore point, creating 59

T

- touchpad
 - illustrated 16
 - removal 38
 - settings 8
 - spare part number 16
 - spare part numbers 38
- touchpad buttons
 - identifying 8
- touchpad cable
 - spare part number 19
- touchpad components 8
- touchpad light, identifying 8
- touchpad settings, adjusting 8
- touchpad zone, identifying 8
- transporting guidelines 22, 28
- traveling with the computer 13

U

- USB board cable
 - spare part number 19
- USB door
 - removal 44
 - spare part numbers 44
- USB SuperSpeed port,
 - identifying 4, 5
- USB Type-C power connector port,
 - identifying 6
- USB Type-C SuperSpeed port,
 - identifying 6

V

- vents, identifying 10, 12
- video, product description 2

W

- Windows
 - backup 59
 - recovery media 59
 - system restore point 59
- Windows key, identifying 12
- Windows tools, using 59
- wireless antennas
 - illustrated 19
 - spare part number 19
- wireless antennas, identifying 7
- wireless certification label 13
- wireless, product description 2
- WLAN antennas, identifying 7
- WLAN device 13
- WLAN label 13
- WLAN module
 - illustrated 17
 - removal 36
 - spare part number 17
 - spare part numbers 36
- workstation guidelines 22