



Mini PC PN42 Series

User Manual



E21455

First Edition

July 2023

COPYRIGHT INFORMATION

No part of this manual, including the products and software described in it, may be reproduced, transmitted, transcribed, stored in a retrieval system, or translated into any language in any form or by any means, except documentation kept by the purchaser for backup purposes, without the express written permission of ASUSTeK COMPUTER INC. ("ASUS").

ASUS PROVIDES THIS MANUAL "AS IS" WITHOUT WARRANTY OF ANY KIND, EITHER EXPRESS OR IMPLIED, INCLUDING BUT NOT LIMITED TO THE IMPLIED WARRANTIES OR CONDITIONS OF MERCHANTABILITY OR FITNESS FOR A PARTICULAR PURPOSE. IN NO EVENT SHALL ASUS, ITS DIRECTORS, OFFICERS, EMPLOYEES OR AGENTS BE LIABLE FOR ANY INDIRECT, SPECIAL, INCIDENTAL, OR CONSEQUENTIAL DAMAGES (INCLUDING DAMAGES FOR LOSS OF PROFITS, LOSS OF BUSINESS, LOSS OF USE OR DATA, INTERRUPTION OF BUSINESS AND THE LIKE), EVEN IF ASUS HAS BEEN ADVISED OF THE POSSIBILITY OF SUCH DAMAGES ARISING FROM ANY DEFECT OR ERROR IN THIS MANUAL OR PRODUCT.

Products and corporate names appearing in this manual may or may not be registered trademarks or copyrights of their respective companies, and are used only for identification or explanation and to the owners' benefit, without intent to infringe.

SPECIFICATIONS AND INFORMATION CONTAINED IN THIS MANUAL ARE FURNISHED FOR INFORMATIONAL USE ONLY, AND ARE SUBJECT TO CHANGE AT ANY TIME WITHOUT NOTICE, AND SHOULD NOT BE CONSTRUED AS A COMMITMENT BY ASUS. ASUS ASSUMES NO RESPONSIBILITY OR LIABILITY FOR ANY ERRORS OR INACCURACIES THAT MAY APPEAR IN THIS MANUAL, INCLUDING THE PRODUCTS AND SOFTWARE DESCRIBED IN IT.

Copyright © 2023 ASUSTeK COMPUTER INC. All Rights Reserved.

LIMITATION OF LIABILITY

Circumstances may arise where because of a default on ASUS' part or other liability, you are entitled to recover damages from ASUS. In each such instance, regardless of the basis on which you are entitled to claim damages from ASUS, ASUS is liable for no more than damages for bodily injury (including death) and damage to real property and tangible personal property; or any other actual and direct damages resulted from omission or failure of performing legal duties under this Warranty Statement, up to the listed contract price of each product.

ASUS will only be responsible for or indemnify you for loss, damages or claims based in contract, tort or infringement under this Warranty Statement.

This limit also applies to ASUS' suppliers and its reseller. It is the maximum for which ASUS, its suppliers, and your reseller are collectively responsible.

UNDER NO CIRCUMSTANCES IS ASUS LIABLE FOR ANY OF THE FOLLOWING: (1) THIRD-PARTY CLAIMS AGAINST YOU FOR DAMAGES; (2) LOSS OF, OR DAMAGE TO, YOUR RECORDS OR DATA; OR (3) SPECIAL, INCIDENTAL, OR INDIRECT DAMAGES OR FOR ANY ECONOMIC CONSEQUENTIAL DAMAGES (INCLUDING LOST PROFITS OR SAVINGS), EVEN IF ASUS, ITS SUPPLIERS OR YOUR RESELLER IS INFORMED OF THEIR POSSIBILITY.

SERVICE AND SUPPORT

Visit our multi-language website at <https://www.asus.com/support/>.

Contents

About this manual.....	5
Conventions used in this manual.....	6
Typography.....	6
Package contents	7

Getting to know your Mini PC

Features.....	10
Front view	10
Left view	12
Right view	13
Rear view.....	14

Using your Mini PC

Getting started	20
Connect the AC power adapter to your Mini PC.....	20
Connect a display panel to your device.....	22
Connect the USB cable from keyboard or mouse	26
Turn on your Mini PC	27
Turning off your Mini PC	28
Putting your Mini PC to sleep.....	28
Entering BIOS Setup	28
Load default BIOS settings.....	29

Upgrading your Mini PC

Removing the bottom cover	32
Replacing the bottom cover.....	33
Installing memory modules.....	34
Installing an M.2 SSD.....	36
Installing a wireless card.....	38

TPM

About the TPM.....	44
--------------------	----

Appendix

Safety information.....	46
Setting up your system	47
Care during use.....	47
Regulatory notices	49
Service and Support	58

About this manual

This manual provides information about the hardware and software features of your Mini PC, organized through the following chapters:

Chapter 1: Getting to know your Mini PC

This chapter details the hardware components of your Mini PC.

Chapter 2: Using your Mini PC

This chapter provides you with information on using your Mini PC.

Chapter 3: Upgrading your Mini PC

This chapter provides you with information on how to upgrade the memory modules, wireless modules, and hard disk drive / solid state drive of your Mini PC.

Chapter 4: TPM

This chapter provides you with information on the TPM options.

Appendix

This section includes notices and safety statements your Mini PC.

Conventions used in this manual

To highlight key information in this manual, some text are presented as follows:

IMPORTANT! This message contains vital information that must be followed to complete a task.

NOTE: This message contains additional information and tips that can help complete tasks.

WARNING! This message contains important information that must be followed to keep you safe while performing certain tasks and prevent damage to your Mini PC's data and components.

Typography

Bold text Indicates a menu or an item to select.

Italic Indicates sections that you can refer to in this manual.

Package contents

Your Mini PC package contains the following items:

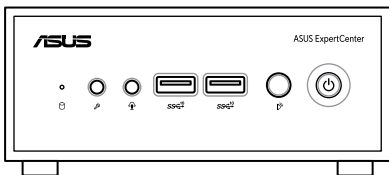

ASUS Mini PC PN Series

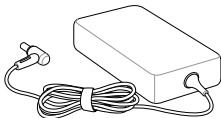

AC power adapter*



Power cord*



Technical documentation

NOTE:

- The most up-to-date and accurate product specifications are available on www.asus.com for download.
 - Product and accessory images are for illustrative purposes only. The actual appearance and specifications may vary depending on the model.
 - *The bundled power adapter may vary depending on the model and the country (or region) of sale.
 - Some bundled accessories may vary depending on the model. For details on these accessories, refer to their respective user manuals.
 - If the device or its components fail or malfunction during normal and proper use within the warranty period, bring the warranty card to the ASUS Service Center for replacement of the defective components.
-





1

***Getting to know your Mini
PC***

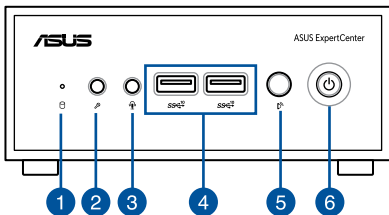
Features

Front view



-  **Drive activity indicator**
This indicator lights up when your Mini PC is accessing the internal storage drive.
-  **Microphone jack**
This port allows you to connect an external microphone.
-  **Headphone/Headset jack**
This port allows you to connect amplified speakers or headphones. You can also use this port to connect your headset.
-  **USB 3.2 Gen 2 port**
The USB 3.2 Gen 2 (Universal Serial Bus) port provides a transfer rate up to 10 Gbit/s.
-  **Infrared (IR) sensor**
The IR sensor detects signals from a remote control, allowing you to access CEC compatible devices that are connected to your MiniPC.

6



Power button

The power button allows you to turn the Mini PC on or off. You can use the power button to put your Mini PC to sleep mode or press it for four (4) seconds to force shutdown your Mini PC.

Left view

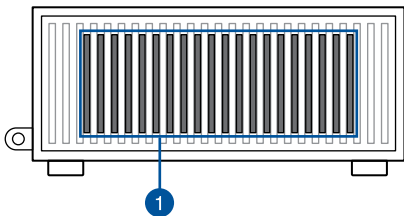

1

Air vents

The air vents allow air to circulate in your Mini PC chassis to prevent overheating.

IMPORTANT! For optimal heat dissipation and air ventilation, ensure that the air vents are free from obstructions.

Right view

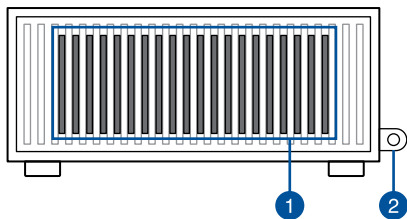

1

Air vents

The air vents allow air to circulate in your Mini PC chassis to prevent overheating.

IMPORTANT! For optimal heat dissipation and air ventilation, ensure that the air vents are free from obstructions.

2

Kensington security slot

The Kensington security slot allows you to secure your Mini PC using Kensington® security products.

Rear view

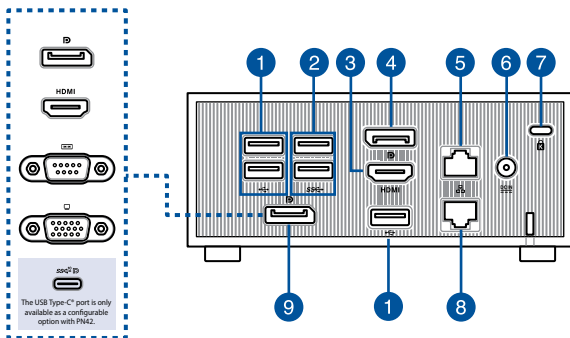

1



USB 2.0 port

The USB (Universal Serial Bus) port is compatible with USB 2.0 devices, such as keyboards, pointing devices, flash disk drives, external HDDs, speakers, cameras and printers.

2



USB 3.2 Gen 1 port

The USB 3.2 Gen 1 (Universal Serial Bus) port provides a transfer rate up to 5 Gbit/s.

3

HDMI **HDMI port**

The HDMI (High Definition Multimedia Interface) port supports a 4K device, such as an LCD TV or monitor, to allow viewing on a larger external display.

NOTE:

- This HDMI port supports CEC (Consumer Electronics Control). Connect any CEC compatible device that you want to control with a remote control to this port, and make sure that the device's HDMI-CEC is enabled.
 - When using only this port as a display output source, this port will support a resolution of up to 4096 x 2160 @60Hz. The resolution may also be affected by the cabling and output device.
-

4



DisplayPort

This port allows you to connect your Mini PC to an external display.

NOTE: When using only this port as a display output source, this port will support a resolution of up to 3840 x 2160 @60Hz. The resolution may also be affected by the cabling and output device.

5



LAN port

The 8-pin RJ-45 LAN port supports a standard Ethernet cable for 10/100/1000/2500 Mbps connection to a local network.

6



Power input

The supplied power adapter converts AC power to DC power for use with this jack. Power supplied through this jack supplies power to the Mini PC. To prevent damage to the Mini PC, always use the supplied power adapter.

WARNING! The power adapter may become warm to hot when in use. Do not cover the adapter and keep it away from your body.

NOTE: Please refer to the following information on the power adapter:

65 W Power adapter: +19.0 Vdc == 3.42 A, +19.5 Vdc == 3.33 A

7



Kensington security slot

The Kensington security slot allows you to secure your Mini PC using Kensington® security products.

8



LAN port (on selected models only)

The 8-pin RJ-45 LAN port supports a standard Ethernet cable for 10/100/1000/2500 Mbps connection to a local network.

Configurable port

This port varies between models and consists of the following port options:



USB 3.2 Gen 2 Type-C® / DisplayPort combo port

(available as an option only with PN42)

This USB Type-C® (Universal Serial Bus) port provides the following:

- Transfer rate of up to 10 Gbit/s.
- Support for DisplayPort 1.4. Use a USB Type-C® adapter to connect your Mini PC to an external display.
- USB power delivery with a maximum of 5V / 3A output.

NOTE: When using only this port as a display output source, this port will support a resolution of up to 3840 x 2160 @60Hz. The resolution may also be affected by the cabling and output device.



DisplayPort

This port allows you to connect your Mini PC to an external display.

NOTE: When using only this port as a display output source, this port will support a resolution of up to 3840 x 2160 @60Hz. The resolution may also be affected by the cabling and output device.

HDMI **HDMI port**

The HDMI (High Definition Multimedia Interface) port supports an 4K device, such as an LCD TV or monitor, to allow viewing on a larger external display.

NOTE: When using only this port as a display output source, this port will support a resolution of up to 4096 x 2160 @60Hz. The resolution may also be affected by the cabling and output device.



Serial (COM) connector

The 9-pin serial (COM) connector allows you to connect devices that have serial ports such as mouse, modem, or printers.



VGA port

This port allows you to connect your Mini PC to an external display.

NOTE: When using only this port as a display output source, this port will support a resolution of up to 1920 x 1200 @60Hz. The resolution may also be affected by the cabling and output device.

2

Using your Mini PC

Getting started

Connect the AC power adapter to your Mini PC

To connect the AC power adapter to your Mini PC:

- A. Connect the power cord to the AC power adapter.
- B. Connect the DC power connector into your Mini PC's power (DC) input.
- C. Plug the AC power adapter into a 100V~240V power source.

NOTE: The power adapter may vary in appearance, depending on the model and the country (or region) of sale.

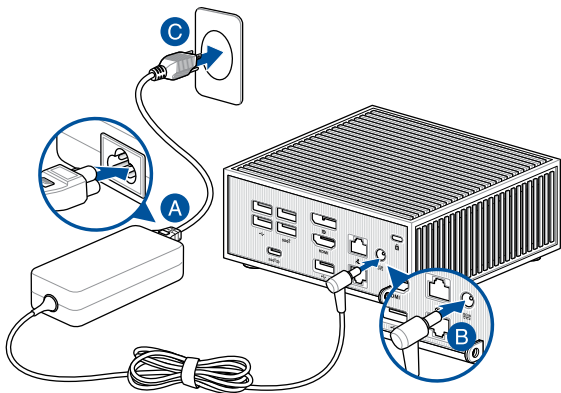

IMPORTANT!

- We strongly recommend that you use only the AC power adapter and cable that came with your Mini PC.
 - We strongly recommend that you use a grounded wall socket while using your Mini PC.
 - The socket outlet must be easily accessible and near your Mini PC.
 - To disconnect your Mini PC from its main power supply, unplug your Mini PC from the power socket.
-

NOTE:

Please refer to the following information on the power adapter:

65W Power adapter

- Input voltage: 100-240Vac
 - Input frequency: 50-60Hz
 - Rating output current: 3.42A / 3.33A (65.0W)
 - Rating output voltage: 19.0V / 19.5V
-

Connect a display panel to your device

You can connect a display panel or projector to your device that has the following connectors:

- VGA port
- HDMI port
- DisplayPort
- USB Type-C® port

NOTE: These ports may vary depending on the model.

To connect a display panel to your Mini PC:

Connect one end of a VGA, HDMI, DisplayPort, or USB Type-C® cable to an external display, and the other end of the cable to your Mini PC's VGA port, HDMI port, DisplayPort, or USB Type-C® port.

NOTE:

- Up to three display panels may be connected, depending on model and selected options*. However, only a maximum of three can be displayed simultaneously.
 - Using one of the ports listed below as the only display output source will provide the following maximum resolution**:
 - HDMI™ port
Supports a resolution of up to 4096 x 2160 @60Hz.
 - DisplayPort
Supports a resolution of up to 3840 x 2160 @60Hz.
 - Configurable USB Type-C® port
Supports a resolution of up to 3840 x 2160 @60Hz.
 - Configurable VGA port
Supports a resolution of up to 1920 x 1200 @60Hz.
 - Configurable HDMI™ port
Supports a resolution of up to 4096 x 2160 @60Hz.
 - Configurable DisplayPort
Supports a resolution of up to 3840 x 2160 @60Hz.
- * **The ports may vary depending on the model. Refer to the Features section for the location of the ports.**
- ** **The maximum resolution may be affected by the cabling and output device.**
-

Connect display via VGA port

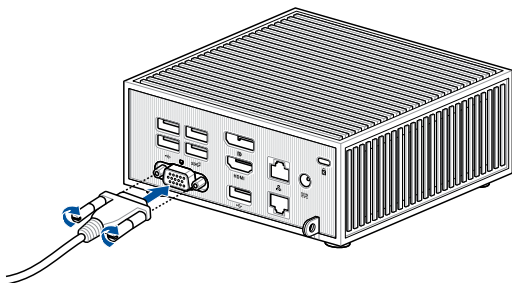

Connect display via HDMI port

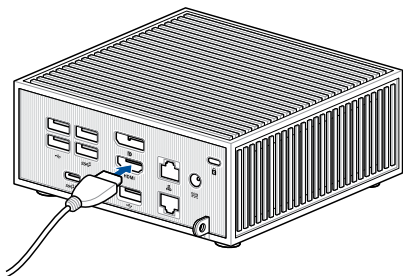

Connect display via DisplayPort

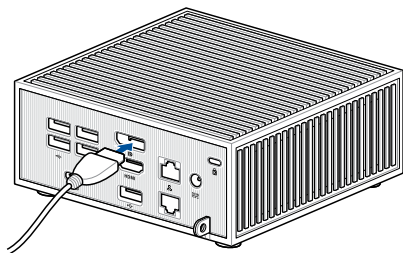

Connect display via USB Type-C® port

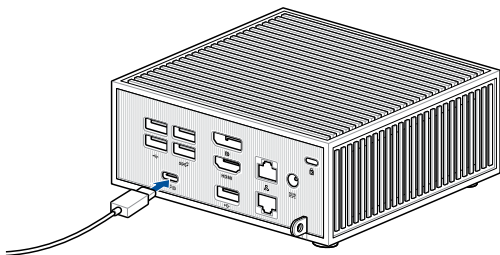

Connect the USB cable from keyboard or mouse

You can connect generally any USB keyboard and mouse to your Mini PC. You can also connect a USB dongle for a wireless keyboard and mouse set.

To connect a keyboard and mouse to your Mini PC:

Connect the USB cable from your keyboard and mouse to any of the USB ports of your Mini PC.

NOTE: The keyboard varies depending on the country (or region) of sale.

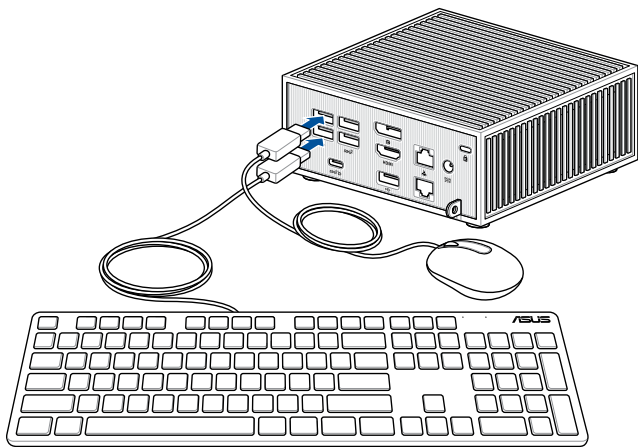

Turn on your Mini PC

Press the power button to turn on your Mini PC.

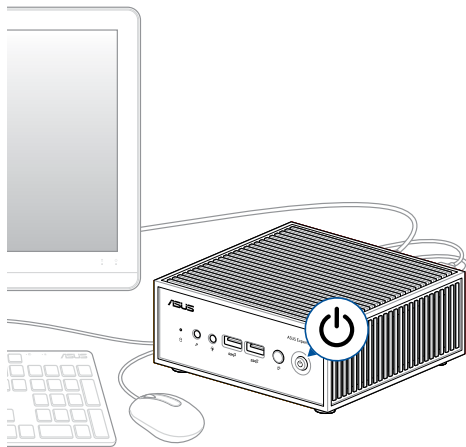

Turning off your Mini PC

If your Mini PC is unresponsive, press and hold the power button for at least four (4) seconds until your Mini PC turns off.

Putting your Mini PC to sleep

To set your Mini PC to enter Sleep mode by pressing the Power button once, search for **Control Panel** in the Windows Search Box, then navigate to **Hardware and Sound > Power Options > Choose what the power button does**, and set **When I press the power button** to **Sleep**.

Entering BIOS Setup

BIOS (Basic Input and Output System) stores system hardware settings that are needed for system startup on the Mini PC.

Under normal circumstances, the default BIOS settings apply to most conditions to ensure optimal performance. Do not change the default BIOS settings except in the following circumstances:

- An error message appears on the screen during the system bootup and requests you to run BIOS Setup.
- You have installed a new system component that requires further BIOS settings or update.

WARNING! Inappropriate BIOS settings may result in instability or boot failure. We strongly recommend that you change the BIOS settings only with the help of a trained service personnel.

Load default BIOS settings

To load the default values for each of the parameters in your BIOS:

1. Enter the BIOS by pressing <F2> or from the POST screen.

NOTE: POST (Power-On Self Test) is a series of software controlled diagnostic tests that run when you turn on your Mini PC.

2. Navigate to the **Exit** menu.
3. Select the **Load Optimized Defaults** option or press <F5>.
4. Select **OK** to load the default BIOS values.

3

Upgrading your Mini PC

IMPORTANT!

- It is recommended that you install or upgrade the memory modules, wireless card, aluminum plate, and solid state drive (SSD), under professional supervision. Visit an ASUS service center for further assistance.
 - Ensure that your hands are dry before proceeding with the rest of the installation process. Before installing any of the features in this guide, use a grounded wrist strap or touch a safely grounded object or metal object to avoid damaging them due to static electricity.
-

NOTE: The illustrations in this section are for reference only. The slots may vary depending on the model.

Removing the bottom cover

1. Turn off your Mini PC then disconnect all cables and peripherals.
2. Place the Mini PC on a flat stable surface, with its top side facing down.
3. Loosen the four (4) screws from the bottom (A), and then lift the bottom cover in the direction shown in the illustration.

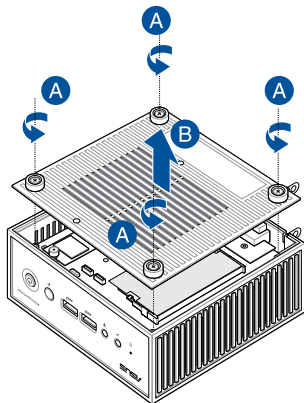

Replacing the bottom cover

1. Place the bottom cover into position as shown.

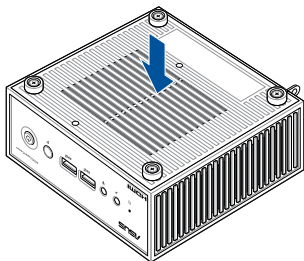

2. Secure the bottom cover using the four (4) screws.

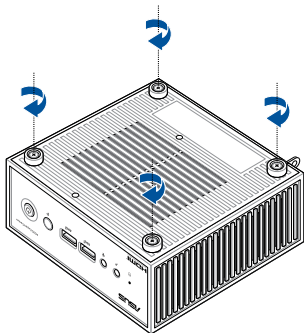

Installing memory modules

Your Mini PC comes with an SO-DIMM memory slot that allows you to install a DDR4 SO-DIMM.

IMPORTANT! Refer to <https://www.asus.com> for the list of compatible DIMMs. You can only install DDR4 SO-DIMMs to the Mini PC's DIMM slot.

1. Carefully lift the EMI film so you have a clear view of the memory slot.
2. Align and insert the memory module into the slot.
3. Press down until it is securely seated in place.
4. Flip the EMI film back to its original position so that it is shielding the memory module.

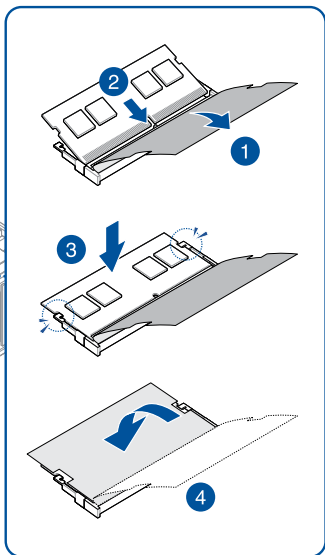
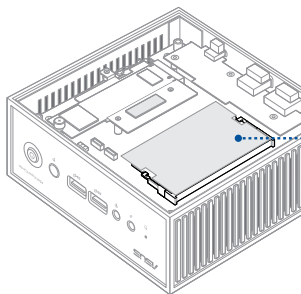

Installing an M.2 SSD

1. Align and insert the 2280 M.2 SSD into its slot inside the Mini PC.
2. Gently push down the 2280 M.2 SSD on top of the standoff and fasten it using one of the bundled 3mm round screws.

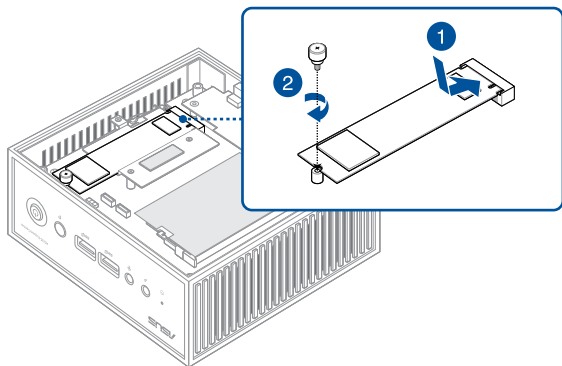

3. Before replacing the bottom cover, ensure to remove the plastic film on the thermal pad, if there is one.

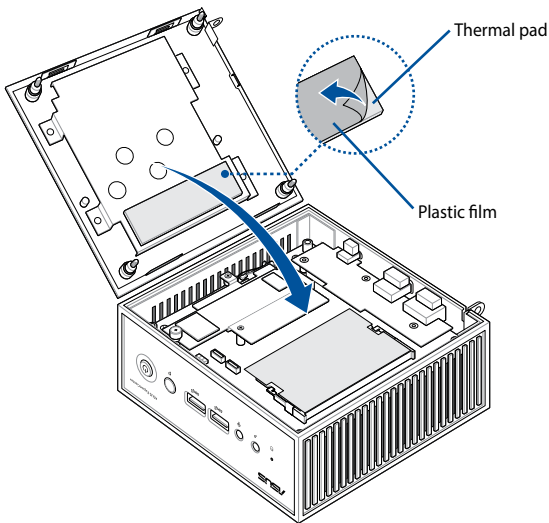

NOTE: The specifications for the thermal pad used in this Mini PC are as follows:

Thickness:	2.5 mm
Size:	65 mm x 20 mm
Thermal conductivity:	3 W/mK
Hardness:	< 40 Sc

CAUTION! Heat dissipation performance may still vary even when you have replaced the thermal pad with one that meets the above specifications. To prevent possible damage to the M.2 SSD, you should have the thermal pad replaced by a service center near you.

Installing a wireless card

NOTE: Your Mini PC includes an M.2 slot for 2230 wireless and Bluetooth modules. Refer to <https://www.asus.com> for the list of compatible wireless and Bluetooth modules.

1. (optional) Remove the M.2 SSD, if one is installed. To remove the M.2 SSD, remove the screw from the standoff, then remove the M.2 SSD.
2. (optional) Remove the aluminum plate, if one is installed. To remove the aluminum plate, first remove the three screws holding it in place, and then lift the plate and set it aside.

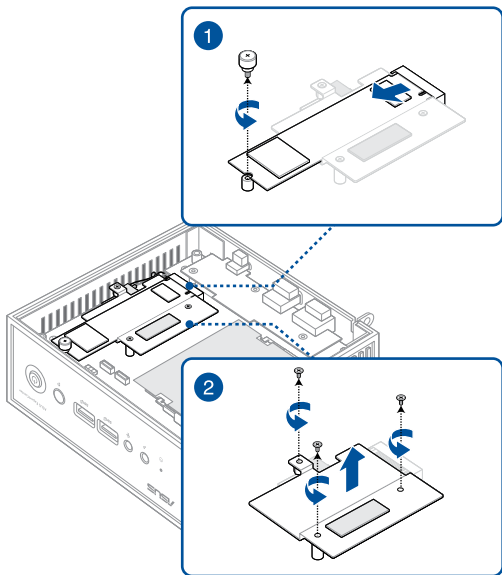

- Align and insert the wireless card into its slot inside the Mini PC, then gently push down the wireless card on top of the standoff.
- Fasten the wireless card using a standoff.
- (optional) Connect the antennas to your wireless card.
- (optional) Organize your antenna cables with the cable holder clips.

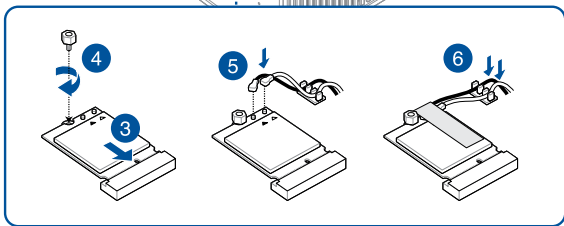
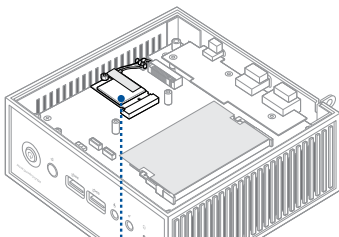

NOTE:

- Connecting antennas to your wireless card may strengthen the wireless signal.
 - A soft clicking sound indicates that the antenna has been securely attached on the wireless card.
-

7. Reinstall the aluminum plate that was removed previously, and secure it with three screws.

NOTE:

If an aluminum plate was not factory pre-installed, you should be able to find one bundled with your Mini PC.

Before installing the aluminum plate, check that the thermal pads on both sides of the aluminum plate have the plastic films removed.

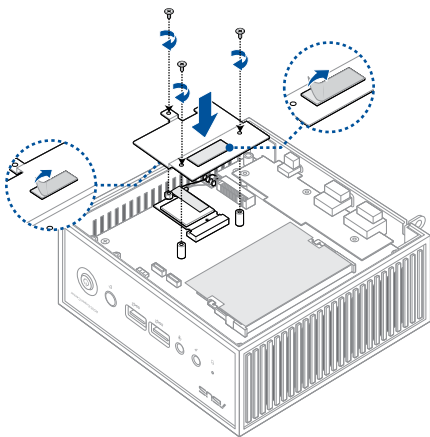

8. (optional) Reinstall the M.2 SSD if one was removed previously.

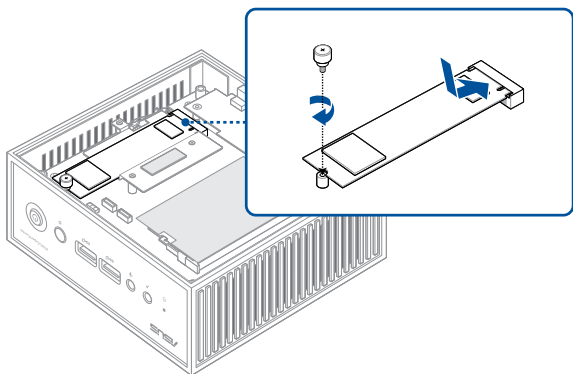



TPM

4

About the TPM

The system comes with two (2) TPM options: firmware TPM (fTPM) or the discrete TPM (dTPM). The dTPM is an onboard chip and the availability of the onboard dTPM chip may vary between models.

NOTE:

- The fTPM is supported by default, but may not be enabled, for more information on enabling the TPM, please refer to www.asus.com/support.
 - The dTPM is optional and is available on selected models
-

You may use the following methods to check whether your system comes with dTPM:

- Using the Windows Security App
 - a. Navigate to **Start > Settings > Update & Security > Windows Security > Device Security**.
 - b. Check if there is a **Security Processor** section on this screen, if there is no **Security Processor** section on this screen, there may not be a dTPM on this model, or the dTPM may be disabled.
- Using the Microsoft Management Console
 - a. Navigate to **Start > Run** or press [**Windows Key**] + **R**.
 - b. Type `tpm.msc`, then choose **OK**.
 - c. If you see a message confirming TPM is ready to use, then there is a dTPM available and enabled. If you see a message saying "Compatible TPM cannot be found", there may not be a dTPM on this model, or the dTPM may be disabled.

For more information on TPM, please refer to FAQ at www.asus.com/support/.

Appendix

Safety information

Your Mini PC is designed and tested to meet the latest standards of safety for information technology equipment. However, to ensure your safety, it is important that you read the following safety instructions.



- Do not ingest battery, Chemical Burn Hazard.
- This product contains a coin / button cell battery. If the coin /button cell battery is swallowed, it can cause severe internal burns in just 2 hours and can lead to death.
- Keep new and used batteries away from children.
- If the battery compartment does not close securely, stop using the product and keep it away from children.
- If you think batteries might have been swallowed or placed inside any part of the body, seek immediate medical attention.

Lithium-Ion Battery Warning

CAUTION! Danger of explosion if battery is incorrectly replaced. Replace only with the same or equivalent type recommended by the manufacturer. Dispose of used batteries according to the manufacturer's instructions.

NO DISASSEMBLY

The warranty does not apply to the products that have been disassembled by users

Setting up your system

- Read and follow all instructions in the documentation before you operate your system.
- Do not use this product near water or a heated source.
- Set up the system on a stable surface.
- Openings on the chassis are for ventilation. Do not block or cover these openings. Make sure you leave plenty of space around the system for ventilation. Never insert objects of any kind into the ventilation openings.
- Use this product in environments with ambient temperatures between 0°C and 35°C.
- If you use an extension cord, make sure that the total ampere rating of the devices plugged into the extension cord does not exceed its ampere rating.
- This product should be connected by means of a power cord to a socket-outlet with earthing connection.
- This equipment should be installed and operated with a minimum distance of 20cm between the radiator and your body.

Care during use

- Do not walk on the power cord or allow anything to rest on it.
- Do not spill water or any other liquids on your system.
- When the system is turned off, a small amount of electrical current still flows. Always unplug the power cord from the power outlets before cleaning the system.
- If you encounter the following technical problems with the product, unplug the power cord and contact a qualified service technician or your retailer.
 - The power cord or plug is damaged.
 - Liquid has been spilled into the system.
 - The system does not function properly even if you follow the operating instructions.
 - The system was dropped or the cabinet is damaged.
 - The system performance changes.

- Avoid contact with hot components inside the Mini PC. During operation, some components become hot enough to burn the skin. Before you open the computer cover, turn off the computer, disconnect the power, and wait approximately 30 minutes for the components to cool.
- Disposal of a battery into fire or a hot oven, or mechanically crushing or cutting of a battery, that can result in an explosion;
- Leaving a battery in an extremely high temperature surrounding environment that can result in an explosion or the leakage of flammable liquid or gas;
- A battery subjected to extremely low air pressure that may result in an explosion or the leakage of flammable liquid or gas.

Safety Precautions

Accessories that came with this product have been designed and verified for the use in connection with this product. Never use accessories for other products to prevent the risk of electric shock or fire.

安全上のご注意

付属品は当該専用品です。他の機器には使用しないでください。機器の破損もしくは、火災や感電の原因となることがあります。

Regulatory notices

COATING NOTICE

IMPORTANT! To provide electrical insulation and maintain electrical safety, a coating is applied to insulate the device except on the areas where the I/O ports are located.

Federal Communications Commission Statement

This device complies with Part 15 of the FCC Rules. Operation is subject to the following two conditions:

- This device may not cause harmful interference, and
- This device must accept any interference received including interference that may cause undesired operation.

This equipment has been tested and found to comply with the limits for a Class B digital device, pursuant to Part 15 of the FCC Rules. These limits are designed to provide reasonable protection against harmful interference in a residential installation.

This equipment generates, uses and can radiate radio frequency energy and, if not installed and used in accordance with manufacturer's instructions, may cause harmful interference to radio communications. However, there is no guarantee that interference will not occur in a particular installation. If this equipment does cause harmful interference to radio or television reception, which can be determined by turning the equipment off and on, the user is encouraged to try to correct the interference by one or more of the following measures:

- Reorient or relocate the receiving antenna.
- Increase the separation between the equipment and receiver.
- Connect the equipment to an outlet on a circuit different from that to which the receiver is connected.
- Consult the dealer or an experienced radio/TV technician for help.

IMPORTANT! Outdoor operations in the 5.15~5.25 GHz band is prohibited. This device has no Ad-hoc capability for 5250~5350 and 5470~5725 MHz.

FCC RF Caution Statement

WARNING! Any changes or modifications not expressly approved by the party responsible for compliance could void your authority to operate the equipment.

RF exposure warning

This equipment must be installed and operated in accordance with provided instructions and the antenna(s) used for this transmitter must be installed to provide a separation distance of at least 20 cm from all persons and must not be co-located or operating in conjunction with any other antenna or transmitter. End-users and installers must be provide with antenna installation instructions and transmitter operating conditions for satisfying RF exposure compliance.

FCC Wi-Fi 6E Caution Statement

FCC regulations restrict the operation of this device to indoor use only. The operation of this device is prohibited on oil platforms, cars, trains, boats, and aircraft, except that operation of this device is permitted in large aircraft while flying above 10,000 feet.

ISED Wi-Fi 6E Caution Statement (RLAN devices)

Devices shall not be used for control of or communications with unmanned aircraft systems.

Les dispositifs ne doivent pas être utilisés pour commander des systèmes d'aéronef sans pilote ni pour communiquer avec de tels systèmes.

ISED Radiation Exposure Statement for Canada

This equipment complies with ISED radiation exposure limits set forth for an uncontrolled environment. To maintain compliance with ISED RF exposure compliance requirements, please avoid direct contact to the transmitting antenna during transmitting. End users must follow the specific operating instructions for satisfying RF exposure compliance.

Operation is subject to the following two conditions:

- This device may not cause interference and
- This device must accept any interference, including interference that may cause undesired operation of the device.

HDMI Trademark Notice

The terms HDMI, HDMI High-Definition Multimedia Interface, and the HDMI Logo are trademarks or registered trademarks of HDMI Licensing Administrator, Inc.

Compliance Statement of Innovation, Science and Economic Development Canada (ISED)

This device complies with Innovation, Science and Economic Development Canada licence exempt RSS standard(s). Operation is subject to the following two conditions: (1) this device may not cause interference, and (2) this device must accept any interference, including interference that may cause undesired operation of the device.

CAN ICES-003(B)/NMB-003(B)

Déclaration de conformité de Innovation, Sciences et Développement économique Canada (ISED)

Le présent appareil est conforme aux CNR d'Innovation, Sciences et Développement économique Canada applicables aux appareils radio exempts de licence. L'exploitation est autorisée aux deux conditions suivantes : (1) l'appareil ne doit pas produire de brouillage, et (2) l'utilisateur de l'appareil doit accepter tout brouillage radioélectrique subi, même si le brouillage est susceptible d'en compromettre le fonctionnement.

CAN ICES-003(B)/NMB-003(B)

Wireless Operation Channel for Different Domains

N. America	2.412-2.462 GHz	Ch01 through CH11
Japan	2.412-2.484 GHz	Ch01 through Ch14
Europe ETSI	2.412-2.472 GHz	Ch01 through Ch13

Declaration of compliance for product environmental regulation

ASUS follows the green design concept to design and manufacture our products, and makes sure that each stage of the product life cycle of ASUS product is in line with global environmental regulations. In addition, ASUS disclose the relevant information based on regulation requirements.

Please refer to <https://csr.asus.com/Compliance.htm> for information disclosure based on regulation requirements ASUS is complied with:

EU REACH and Article 33

Complying with the REACH (Registration, Evaluation, Authorization, and Restriction of Chemicals) regulatory framework, we publish the chemical substances in our products at ASUS REACH website at

<https://csr.asus.com/english/REACH.htm>

EU RoHS

This product complies with the EU RoHS Directive. For more details, see

<https://csr.asus.com/english/article.aspx?id=35>

Japan JIS-C-0950 Material Declarations

Information on Japan RoHS (JIS-C-0950) chemical disclosures is available on

<https://csr.asus.com/english/article.aspx?id=19>

India RoHS

This product complies with the “India E-Waste (Management) Rules, 2016” and prohibits use of lead, mercury, hexavalent chromium, polybrominated biphenyls (PBBs) and polybrominated diphenyl ethers (PBDEs) in concentrations exceeding 0.1% by weight in homogenous materials and 0.01% by weight in homogenous materials for cadmium, except for the exemptions listed in Schedule II of the Rule.

Vietnam RoHS

ASUS products sold in Vietnam, on or after September 23, 2011, meet the requirements of the Vietnam Circular 30/2011/TT-BCT.

Các sản phẩm ASUS bán tại Việt Nam, vào ngày 23 tháng 9 năm 2011 trở về sau, đều phải đáp ứng các yêu cầu của Thông tư 30/2011/TT-BCT của Việt Nam.

Türkiye RoHS

AEEE Yönetmeliğine Uygundur

ASUS Recycling/Takeback Services

ASUS recycling and takeback programs come from our commitment to the highest standards for protecting our environment. We believe in providing solutions for you to be able to responsibly recycle our products, batteries, other components as well as the packaging materials. Please go to <https://csr.asus.com/english/Takeback.htm> for detailed recycling information in different regions.

Ecodesign Directive

European Union announced a framework for the setting of ecodesign requirements for energy-related products (2009/125/EC). Specific Implementing Measures are aimed at improving environmental performance of specific products or across multiple product types. ASUS provides product information on the CSR website. The further information could be found at <https://csr.asus.com/english/article.aspx?id=1555>.



DO NOT throw the device in municipal waste. This product has been designed to enable proper reuse of parts and recycling. This symbol of the crossed out wheeled bin indicates that the product (electrical, electronic equipment, and mercury-containing button cell battery) should not be placed in municipal waste. Check local technical support services for product recycling.

EPEAT (Electronic Product Environmental Assessment Tool) registered products

The public disclosure of key environmental information for ASUS EPEAT registered products is available on CSR website <https://csr.asus.com/english/article.aspx?id=41>. More information about EPEAT program and purchaser guidance can be found on the EPEAT website www.epeat.net.

ENERGY STAR® Qualified Product

ENERGY STAR® is a joint program of the U.S. Environmental Protection Agency and the U.S. Department of Energy helping us all save money and protect the environment through energy efficient products and practices.



All ASUS products with the ENERGY STAR® logo comply with the ENERGY STAR® standard, and the power management feature is enabled by default. The monitor is automatically set to sleep after 10 minutes of user inactivity; the computer is automatically set to sleep after 30 minutes of user

inactivity. To wake your computer, click the mouse, press any key on the keyboard, or press the power button.

Please visit <http://www.energystar.gov/powermanagement> for detail information on power management and its benefits to the environment. In addition, please visit <http://www.energystar.gov> for detail information on the ENERGY STAR® joint program.

NOTE: ENERGY STAR® is NOT supported on FreeDOS and Linux-based operating systems.

Simplified EU Declaration of Conformity

ASUSTek Computer Inc. hereby declares that this device is in compliance with the essential requirements and other relevant provisions of Directive 2014/53/EU. Full text of EU declaration of conformity is available at <https://www.asus.com/support/>.

The WiFi operating in the band 5150-5350 MHz shall be restricted to indoor use for countries listed in the table below:

a. Low Power Indoor (LPI) Wi-Fi 6E devices:

The device is restricted to indoor use only when operating in the 5945 to 6425 MHz frequency range in Belgium (BE), Bulgaria (BG), Cyprus (CY), Czech Republic (CZ), Estonia (EE), France (FR), Iceland (IS), Ireland (IE), Lithuania (LT), Germany (DE), Netherlands (NL), Spain (ES), Denmark (DK), Italy (IT), Sweden (SE), Switzerland (CH), and Slovenia (SI).

b. Very Low Power (VLP) Wi-Fi 6E devices (portable devices):

The device is not permitted to be used on Unmanned Aircraft Systems (UAS) when operating in the 5945 to 6425 MHz frequency range in Belgium (BE), Bulgaria (BG), Cyprus (CY), Czech Republic (CZ), Estonia (EE), France (FR), Iceland (IS), Ireland (IE), Lithuania (LT), Germany (DE), Netherlands (NL), Spain (ES), Denmark (DK), Italy (IT), Sweden (SE), Switzerland (CH), and Slovenia (SI).

AT	BE	BG	CZ	DK	EE	FR
DE	IS	IE	IT	EL	ES	CY
LV	LI	LT	LU	HU	MT	NL
NO	PL	PT	RO	SI	SK	TR
FI	SE	CH	HR	UK (NI)		



Simplified UKCA Declaration of Conformity

ASUSTek Computer Inc. hereby declares that this device is in compliance with the essential requirements and other relevant provisions of The Radio Equipment Regulations 2017 (S.I. 2017/1206). Full text of UKCA declaration of conformity is available at <https://www.asus.com/support/>.

The WiFi operating in the band 5150-5350 MHz shall be restricted to indoor use for the country listed below:

UK

- a. Low Power Indoor (LPI) Wi-Fi 6E devices:
The device is restricted to indoor use only when operating in the 5925 to 6425 MHz frequency range in UK.
- b. Very Low Power (VLP) Wi-Fi 6E devices (portable devices):
The device is not permitted to be used on Unmanned Aircraft Systems (UAS) when operating in the 5925 to 6425 MHz frequency range in UK.

Wi-Fi Network Notice

IMPORTANT! Wi-Fi 6E network card is available on selected models. The connectivity of Wi-Fi 6E band may vary according to the regulation and certification of each country/region.

Service and Support

Visit our multi-language website at <https://www.asus.com/support/>.

