

Quick Installation Guide

Ceiling Mount Access Point



Scan for
EAP Start Guide

Note: EAP720 is used as an example throughout the guide. Images may differ from your actual product.
©2025 TP-Link 710000064 REV1.0.0

Package Contents

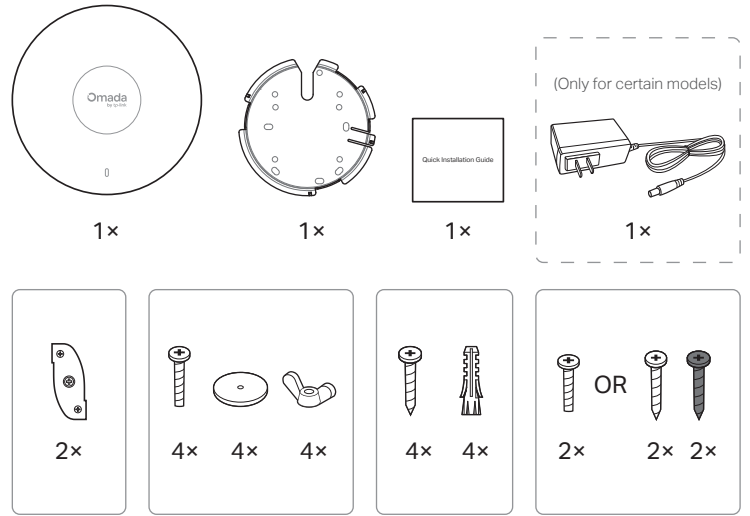

Note: Accessories may vary by region.

Installation

Option 1
Ceiling Mounting (on a Tile)

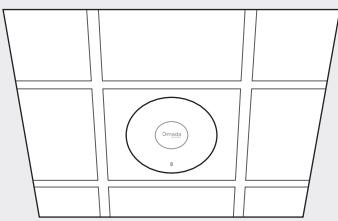

Option 2
Ceiling Mounting (on a T-bar)

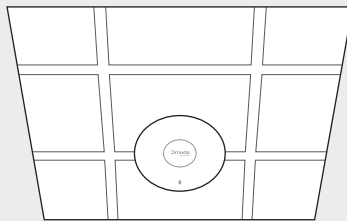

Option 3
Wall Mounting

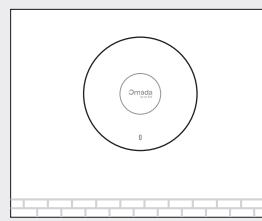

Option 4
Junction Box Mounting

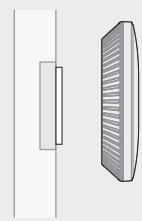

Option 1

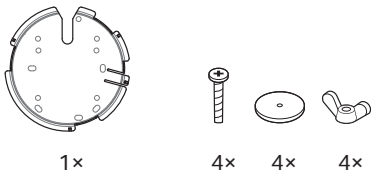
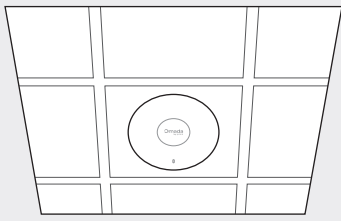

1

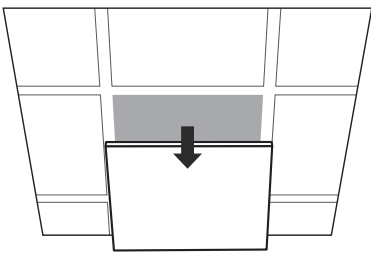

2

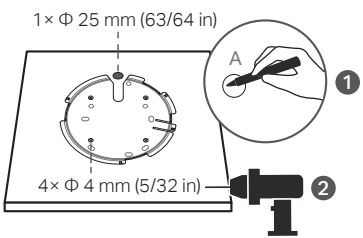

3

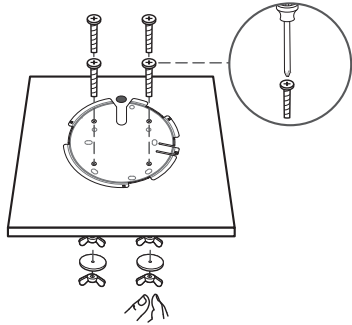

4

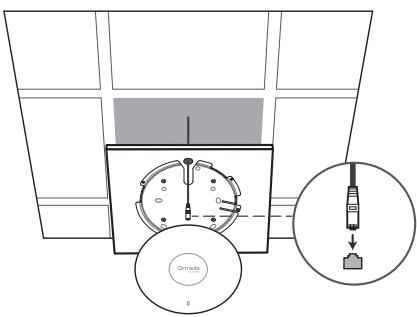

5

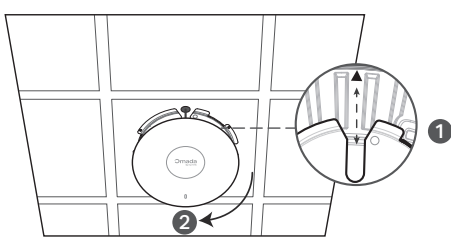

Option 2

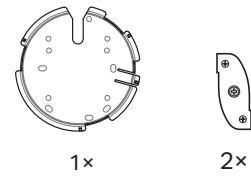
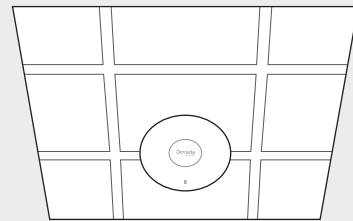

1

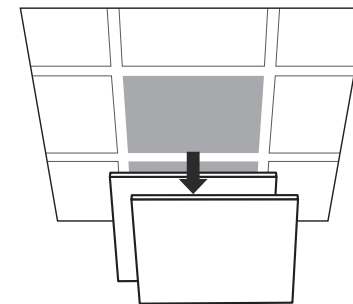

2

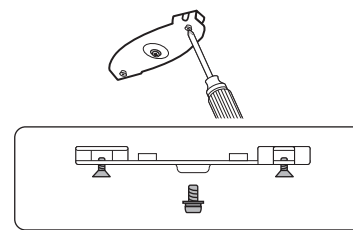

3

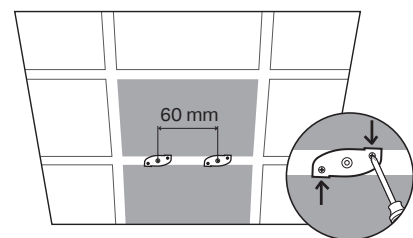

4

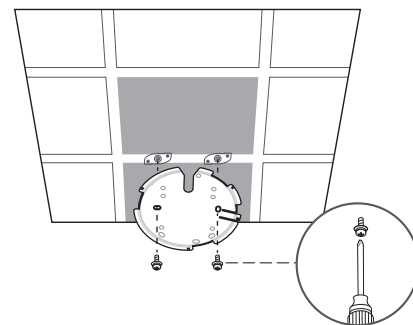

5

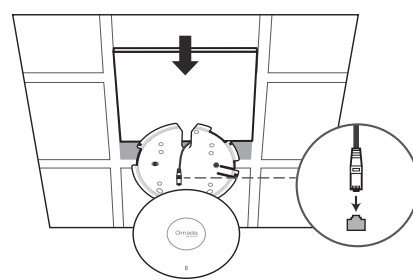

6

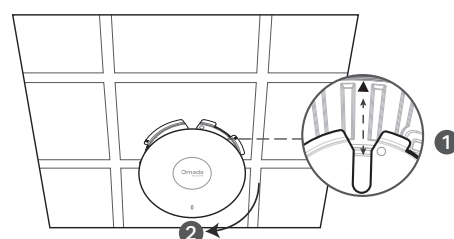

Option 3

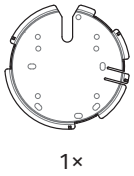
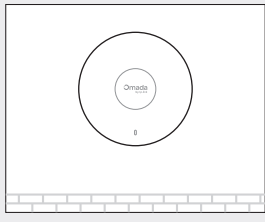

1x



4x



4x

1

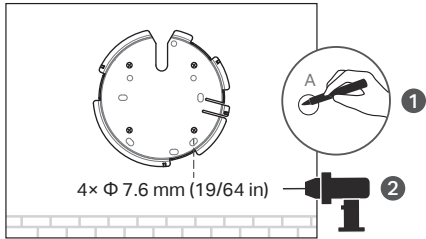

4x Φ 7.6 mm (19/64 in)

2

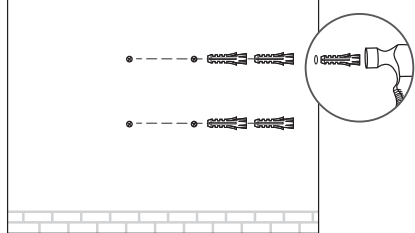

3

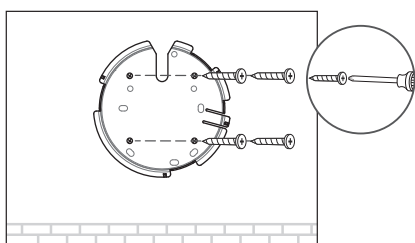

4

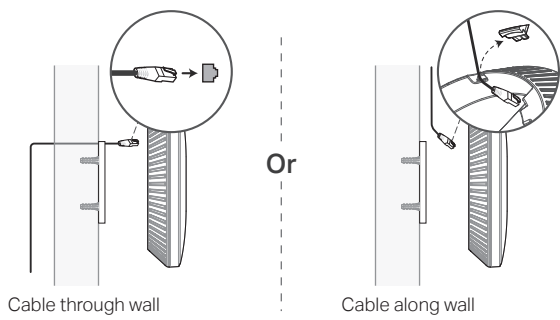

Cable through wall

Cable along wall

5

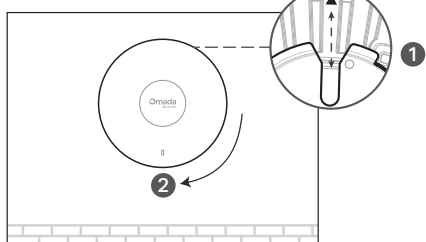

Option 4



1x



2x



2x



2x

Choose the accessory screws that fit your junction box. Compatible wall junctions are as follows:

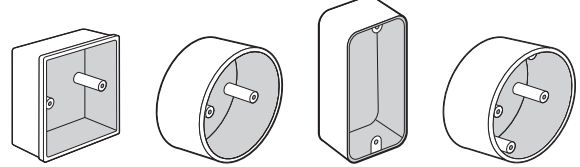

For simplicity, an 86 mm wall junction box is used as an example.

1

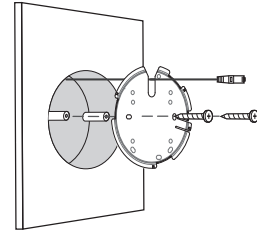

2

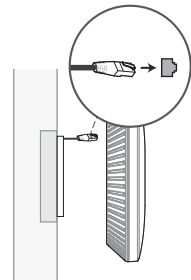

3

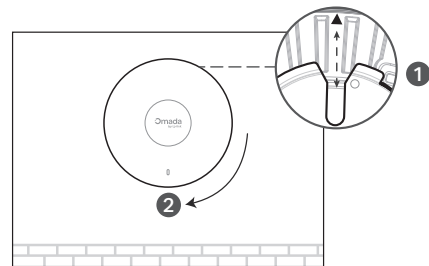

Power On

Option 1: Via PoE Switch

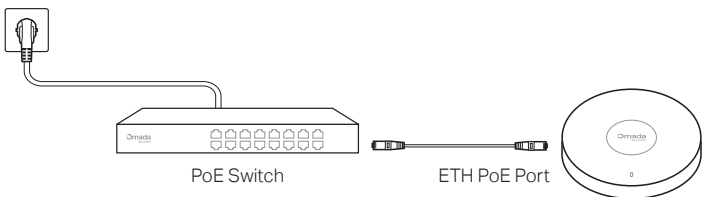

Option 2: Via Power Adapter

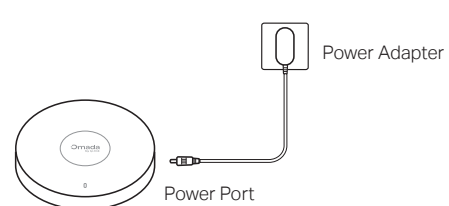

Configuration

Option 1: Standalone Mode

Configure and manage each EAP on its standalone page.

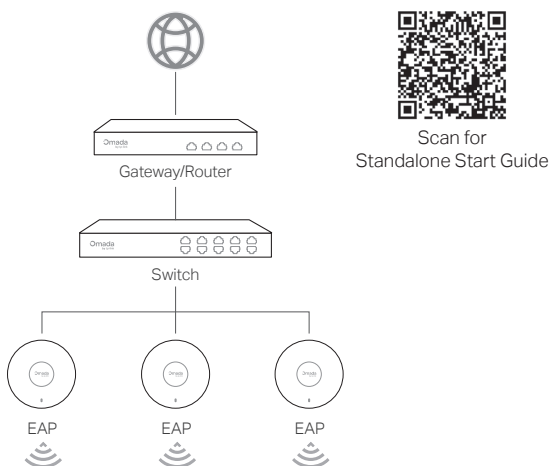

Option 2: Controller Mode

Configure and manage EAPs (and other Omada devices) centrally with an Omada Controller.

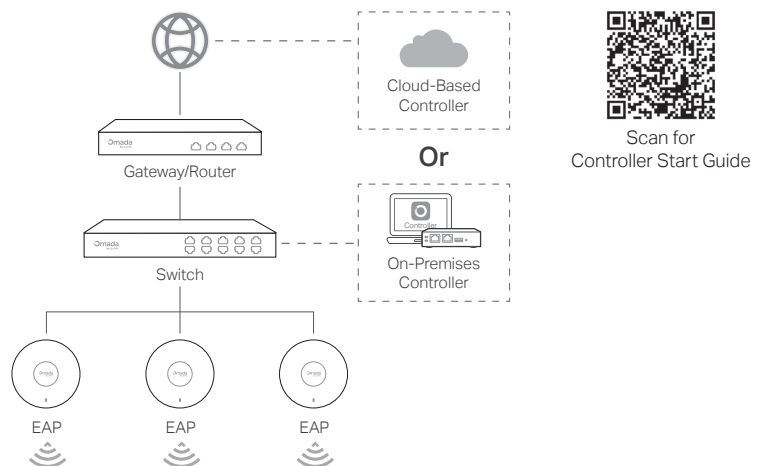

Omada App

With the TP-Link Omada app, you can access and manage your Omada devices at a local site or remotely with a tap of your phone.



Scan for Omada App

More Configurations

For more configurations, refer to the User Guides of the Omada Controller and Omada Access Points at: <https://support.omadanetworks.com/document/>



Safety Information

- Keep the device away from water, fire, humidity or hot environments.
- Do not attempt to disassemble, repair, or modify the device. If you need service, please contact us.
- Do not use the device where wireless devices are not allowed.
- The EAP can be powered only by a power adapter or a PSE device (such as a PoE switch) which complies with Power Source Class 2 (PS2) or Limited Power Source (LPS) defined in the standard of IEC 62368-1.

For models with adapters:

- Do not use damaged charger or USB cable to charge the device.
- Do not use any other chargers than those recommended.
- Adapter shall be installed near the equipment and shall be easily accessible.
- The socket-outlet shall be installed near the equipment and shall be easily accessible.

TP-Link hereby declares that the device is in compliance with the essential requirements and other relevant provisions of directives 2014/53/EU, 2009/125/EC, 2011/65/EU, and (EU) 2015/863. The original EU Declaration of Conformity may be found at <https://www.tp-link.com/en/support/ce/>

TP-Link hereby declares that the device is in compliance with the essential requirements and other relevant provisions of the Radio Equipment Regulations 2017. The original UK Declaration of Conformity may be found at <https://www.tp-link.com/support/ukca/>

More Resources

Main Site	https://www.omadanetworks.com/
Video Center	https://support.omadanetworks.com/video/
Documents	https://support.omadanetworks.com/document/
Product Support	https://support.omadanetworks.com/product/
Technical Support	https://support.omadanetworks.com/contact-support/

Warranty

For details on the warranty period, policy, and procedures, visit <https://support.omadanetworks.com/warranty-services/>.

Support

For technical support, user guides, and other information, please visit <https://support.omadanetworks.com/>, or simply scan the QR code.

