



Wechat
Official Account
神牛微信公众号

深圳市神牛摄影器材有限公司

地址：深圳市宝安区福海街道塘尾社区耀川工业园厂房 2 栋
电话：0755-29609320 (8062) 传真：0755-25723423 邮箱：godox@godox.com

GODOX Photo Equipment Co., Ltd.

Add.: Building 2, Yaochuan Industrial Zone, Tangwei Community, Fuhai Street, Bao'an District, Shenzhen
518103, China Tel: +86-755-29609320(8062) Fax: +86-755-25723423 E-mail: godox@godox.com

www.godox.com

Made in China | 705-ML10R0-02



Godox

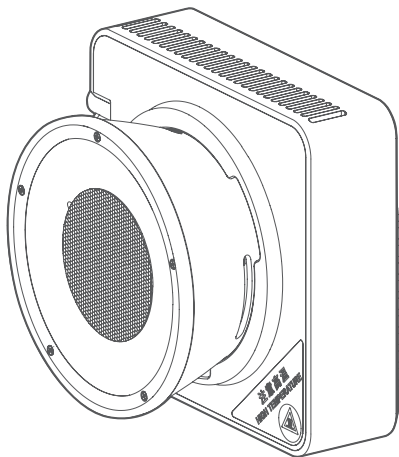

ML100 R

神牛全彩 LED 摄影灯
Godox Full color LED Video Light

使用手册
Instruction Manual

V1.2 说明书 / Instruction Manual

V1.00 固件 / Firmware

重要的安全说明及注意事项

首先作为最基本原则：本产品为专业灯光布景设备，应由专业灯光师使用或在专业人士指导下使用。使用时必须始终遵循基本的安全预防措施，具体安全预防措施如下：

1. 使用前必须阅读并理解产品说明书。
2. 专业灯具，禁止儿童使用。当儿童靠近时，家长或陪护人必须密切监督，以免儿童因碰撞灯具或私用灯具造成人身伤害。
3. 本灯具并非普通照明灯具，不可用于普通照明，任何有过眼部损伤或眼部敏感的人群均应避免使用本灯具。
4. 灯具点亮时，必须小心使用，禁止接触高温部件，如 LED 灯珠，以免造成灼伤。
5. 灯具点亮时，任何情况下均禁止直视灯珠。应该在专业灯光师指导下使用强光，任何情况下避免长时间处于强光环境，如引起眼睛不适，请及时关闭灯具，暂停使用，请及时就医。
6. 倘灯珠损坏或因热变形，应停止使用，并及时联系制造商、服务代理商或合格的维修人员更换灯珠，以免发生意外。
7. 请勿使用损坏的设备或设备配件，待专业维修人员检查维修，确认设备正常方可使用。
8. 在使用过程中，如果本产品由于跌落、受到挤压或遭受强烈冲击而造成外壳破裂的，请勿继续使用，以免因接触到内部电子元件而受到电击伤害。
9. 如需要延长线，请使用额定电流 \geq 该设备额定电流的延长线。如延长线额定电流小于该设备，可能导致过热。
10. 部分产品电源线较长，请合理放置电源线，使其处于安全位置。避免电源线接触过热物体表面、避免放置不当导致拉扯损坏或绊倒现场人员。请使用本厂原装电源线，如使用非本厂电源线导致产品损坏，一概不在本厂维修范围内。
11. 在清洁和维修之前，请务必从电源插座上拔下该设备插头。不使用时，禁止拉扯电源线以将设备插头从电源插座中拔出。正常断电，应是用手抓住该设备插头两端，将插头从电源插座中拔出。此设备需连接到接地插座中。
12. 本设备没有防水性能，请让设备保持干燥，请勿将本设备浸入水中或其他液体中。设备需安装在干燥且通风处，避免在雨天、潮湿、多尘或过热环境下使用。请勿将任何物体置于灯具上或使液体流入灯具内部，以免发生意外。
13. 请勿私自拆卸产品，如产品出现故障，须由本公司或授权的维修人员进行检查维修。
14. 存放本设备之前，请确保设备已完全冷却。存放时，将电源线从设备上拔出。设备应放置于

设备便携包内或通风干燥处。

15. 请勿将设备放置在酒精、汽油等易燃易挥发的溶剂附近。
16. 本厂不推荐的产品附件，请勿使用，以免导致火灾、触电或人身伤害。
17. 请务必经常清洁灯珠玻璃并使其保持干净，玻璃如粘上蚊虫尸体或深色有机物污渍，可能引起玻璃炸裂；清洁本设备时，请勿用湿布擦拭，请用干燥的软布擦拭设备污垢。
18. 本产品已通过 ROHS, CE 和 FCC 认证，请参考相关国家标准使用和操作。
19. 安全说明依据本厂严格测试制定，设备设计和规格如有变更，恕不另行通知。客户可以上神牛官网查看最新的电子版说明，了解产品最新资讯。
20. 一年保修期，消耗品电池、适配器、电源线等配件不在此保修范围内。
21. 经发现，擅自检修设备，将取消一年保修期，维修需要收取相关费用。
22. 对于不规范操作引起的机器故障不在保修范围内。
23. 设备在使用时请注意灯头表面壳体的高温，切勿长时间触摸；设备在结束工作后表面仍会留有较高余温，请等待灯体冷却后再进行长时间触摸。



请勿直视光源

前言

感谢您购买神牛产品！

神牛全新推出全彩 LED 摄影灯 ML100R，以全彩光色含 14 类光效，机身方正而薄便于携带，底部设有 1/4"螺丝口，可兼容市面上绝大多数三脚架，内置蓝牙可无线控制等诸多特性完美适用于户外直播、室内直播、视频拍摄等场景。

本设备包含型号核准代码为：CMIIT ID: 2020DP13510，为该产品的无线电发射模块。

部件名称

1. 显示屏
2. 开关 /MENU 按键
3. MODE 按键
4. 调节按钮 (滚动 / 短按)
5. 风扇口
6. 卡口推制
7. 神牛卡口
8. DC 输入接口
9. USB-C 输入接口
10. 1/4" 接口

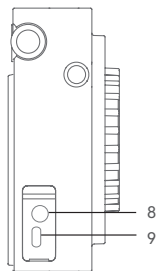
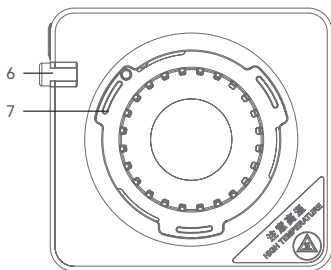
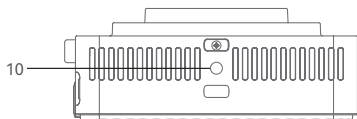
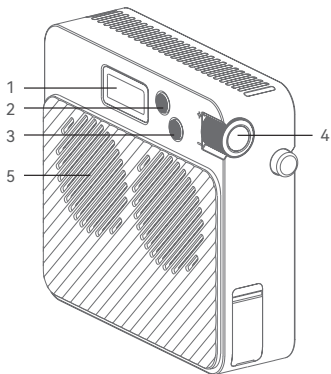

ML100R L 物品清单

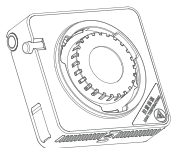

灯体 ×1

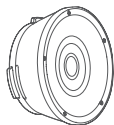

透镜反光杯 ML-L15 ×1

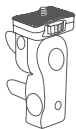

支架 AD-E2 ×1



说明书 ×1

ML100R 物品清单

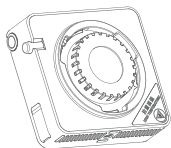

灯体 ×1

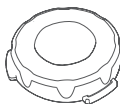

灯头保护罩 ×1

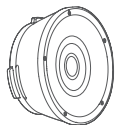

透镜反光杯 ML-L15 ×1

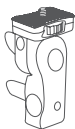

支架 AD-E2 ×1

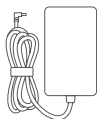

适配器 ×1



AC 电源线 ×1



收纳包 ×1



说明书 ×1

ML100R Kit1 物品清单

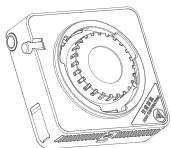

灯体 ×1

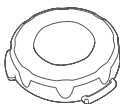

灯头保护罩 ×1

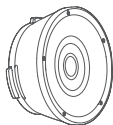

透镜反光杯 ML-L15 ×1



支架 AD-E2 ×1

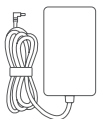

适配器 ×1



AC 电源线 ×1



透镜反光杯 ML-L36 ×1

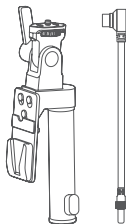

V 口电池附件套装 AK-B02 ×1



收纳包 ×1



说明书 ×1

ML100R Kit2 物品清单

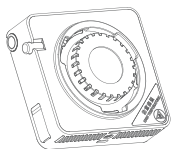

灯体 ×1

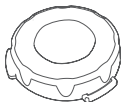

灯头保护罩 ×1

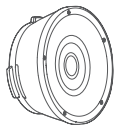

透镜反光杯 ML-L15 ×1



支架 AD-E2 ×1

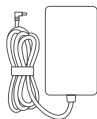

适配器 ×1



AC 电源线 ×1



透镜反光杯 ML-L36 ×1

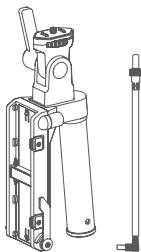

NP-F 电池附件套装 AK-B01 ×1



收纳包 ×1



说明书 ×1

ML100R Kit3 物品清单

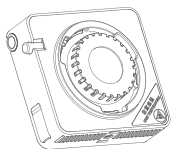

灯体 ×1

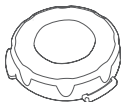

灯头保护罩 ×1

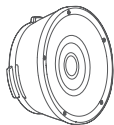

透镜反光杯 ML-L15 ×1



支架 AD-E2 ×1

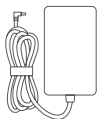

适配器 ×1



AC 电源线 ×1



透镜反光杯 ML-L36 ×1

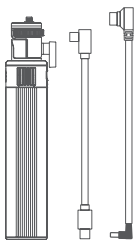

神牛电池手柄
(带移动电源功能) BG02 ×1



收纳包 ×1



说明书 ×1

ML100R Kit4 物品清单

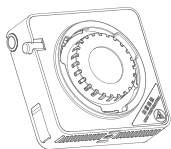

灯体 ×1

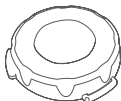

灯头保护罩 ×1



透镜反光杯 ML-L15 ×1

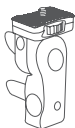

支架 AD-E2 ×1

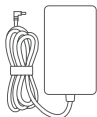

适配器 ×1



AC 电源线 ×1



透镜反光杯 ML-L36 ×1

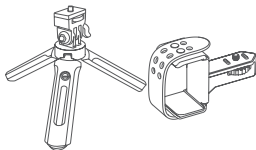

固定支架套装 ×1



收纳包 ×1



说明书 ×1

温馨提示：说明书中线图均为示意图，仅供参考。由于产品不断更新与升级，产品实物与线图可能存在差异，请以实物为准。

另购附件

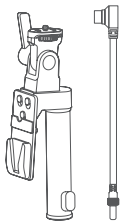

V口电池附件套装
AK-B02

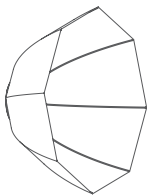

八角柔光箱
ML-SF50

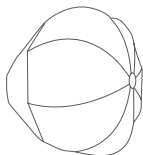

30cm 柔光球
ML-CS30

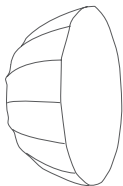

60cm 柔光箱
AD-S60S



透镜反光杯
ML-L15



透镜反光杯
ML-L36



神牛转保荣卡口转接环
ML-GB

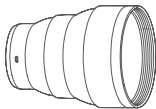

菲涅尔附件
ML-CFL5

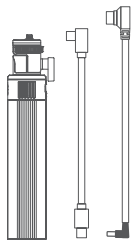

神牛电池手柄
(带移动电源功能)
BG02

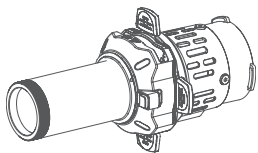

神牛口 LED 灯投影筒
ML-SP-19° Kit

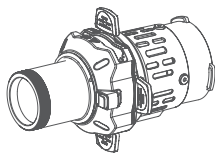

神牛口 LED 灯投影筒
ML-SP-36° Kit

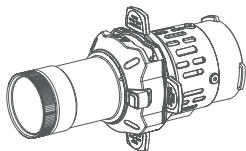

神牛口 LED 灯投影筒
ML-SP-50° Kit

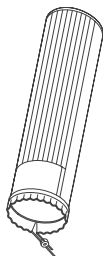

柔光气柱
ML-S1A

安装灯头保护罩 / 透镜反光杯

将灯头保护罩或透镜反光杯对准灯头卡口插入，顺时针旋转安装。

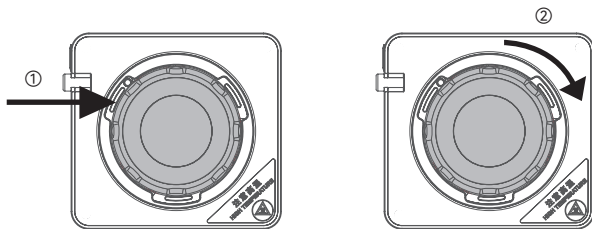

安装灯头保护罩

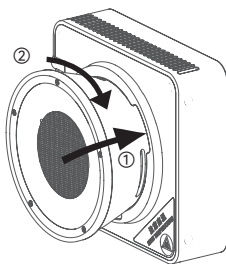

安装透镜反光杯

拆卸灯头保护罩 / 透镜反光杯

按住卡口推制，逆时针旋转灯头保护罩或透镜反光杯即可。

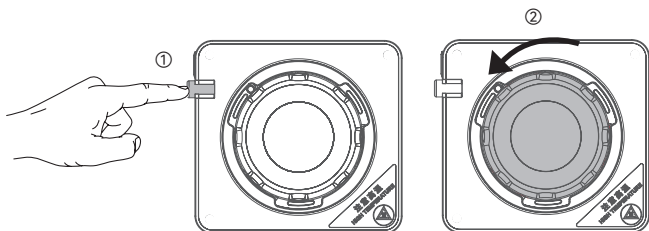

拆卸灯头保护罩

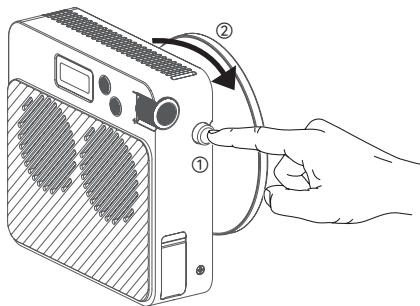

拆卸透镜反光杯

注：灯珠点亮前请将灯头保护罩取下。

供电方式

DC 输入接口: 适配器接入交流电后与灯体 DC 输入接口连接。

USB-C 输入接口: 另购 18W 以上的充电头或充电宝进行供电, 具体输出亮度将根据使用的充电头或充电宝的功率值来调整。

注: ML100R L 套装不含适配器, 需另购。

开机 / 关机

接通电源后, 长按开关按键实现开机, 再次长按实现关机; 菜单中开启快速开机功能, 开机无需长按按键。

模式选择

短按 MODE 按键进入模式选择, 滚动调节按钮可选图中任何一种模式, 短按调节按钮进入该模式的具体设置。通过短按并滚动调节按钮设置参数值, 向上滚动递增参数值, 向下滚动递减参数值。

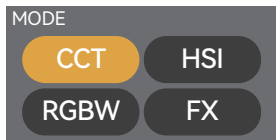

CCT 模式

选中 CCT 后短按调节按钮进入, 滚动调节按钮可选亮度 / 色温 / GM。

亮度范围: 0% ~ 100%

色温范围: 1800K ~ 10000K

GM 范围: -100% ~ +100%

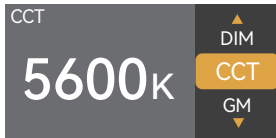

HSI 模式

选中 HSI 后短按调节按钮进入, 滚动调节按钮可选亮度 / 色相 / 饱和度。

亮度范围: 0% ~ 100%

色相范围: 0° ~ 360°

饱和度范围: 0% ~ 100%

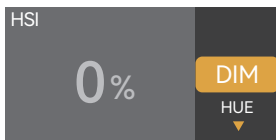

RGBW 模式

选中 RGBW 后短按调节按钮进入，滚动调节按钮
可选亮度 / 红光 / 绿光 / 蓝光 / 白光。

亮度范围: 0% ~ 100%

红光范围: 0% ~ 100%

绿光范围: 0% ~ 100%

蓝光范围: 0% ~ 100%

白光范围: 0% ~ 100%

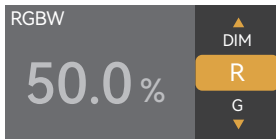

FX 模式

选中 FX 后短按调节按钮进入，滚动调节按钮
可选以下 14 类光效。



1. 闪光灯

此光效模拟闪光灯闪光或传统镁光灯闪光，常用于营造一种生动、活泼的氛围。

开关: 开启 / 关闭

亮度: 0% -100%

颜色: CCT/HSI

色温 / 色相: 1800K-10000K/0-360°

速度: 1-100

模式: 闪光灯 / 镁光灯

触发: 自动 / 手动

2. 雷闪电

此光效模拟雷电的闪电，常用于营造一种紧张、恐怖或神秘的氛围。

开关: 开启 / 关闭

亮度: 0% -100%

色温: 1800K-10000K

闪烁次数: 随机 /1-10

频率: 随机 /2-20

触发: 自动 / 手动

3. 多云

此光效模拟云层遮挡效果，常用于营造一种阴沉、压抑或悲伤氛围。

开关: 开启 / 关闭

亮度: 0% -100%

亮暗比例: 30%-90%

速度: 随机 /1-100

4. 坏灯泡

此光效模拟一盏损坏的灯泡闪光，常用于营造昏黄的环境氛围。

开关: 开启 / 关闭

亮度: 0% -100%

颜色: CCT/HSI

色温 / 色相: 1800K-10000K/0-360°

速度: 1-100

5. 电视机

此光效模拟电视机或屏幕的光线效果，常用于营造出一种冷淡、机械或数字化的氛围。

开关: 开启 / 关闭

亮度: 0% -100%

颜色: CCT/HSI

速度: 1-100

6. 蜡烛

此光效模拟蜡烛的光线效果，常用于营造出一种柔和、温暖、闪烁的氛围。

开关: 开启 / 关闭

亮度: 0% -100%

速度: 1-100

7. 火

此光效模拟火焰的光线效果，常用于营造出一种明亮、热烈、闪烁氛围。

开关: 开启 / 关闭

亮度: 0% -100%

速度: 1-100

8. 烟花

此光效模拟烟花的光线效果，常用于营造出一种绚丽、多彩、浪漫的氛围。

开关: 开启 / 关闭

亮度: 0% -100%

余烬: 1-100

速度: 1-100

9. 爆炸

此光效模拟爆炸的光线效果，常用于营造出一种明亮、猛烈、闪烁氛围。

开关: 开启 / 关闭

亮度: 0% -100%

颜色: CCT/HSI

色温 / 色相: 1800K-10000K/0-360°

余烬: 1-100

速度: 1-100

触发: 自动 / 手动

10. 焊接

此光效模拟焊接的光线效果，常用于营造出一种炽热、机械的氛围。

开关: 开启 / 关闭

亮度: 0% -100%

颜色: CCT/HSI

色温 / 色相: 1800K-10000K/0-360°

速度: 1-100

11. 警车

此光效模拟警车灯光的闪烁效果，常用于营造紧张、追逐或紧张氛围。

开关: 开启 / 关闭

亮度: 0% -100%

颜色: 红 + 蓝、红、蓝、蓝 + 白、蓝 + 黄、黄、红 + 白 + 蓝、红 + 黄 + 蓝

模式: 1-5

12.SOS SOS

此光效模拟 SOS 求救信号的闪烁效果，常用于营造危险、求救或紧急情况氛围。

开关: 开启 / 关闭

亮度: 0% -100%

颜色: CCT/HSI

色温 / 色相: 1800K-10000K/0-360°

13. 彩光循环

此光效模拟彩色光线的循环和变化效果，常用于营造一种梦幻、科幻的氛围。

开关: 开启 / 关闭

亮度: 0% -100%

饱和度: 0%-100%

速度: 1-100

14. 派对

此光效模拟彩色光线、闪光灯和激光等效果，常用于营造出一种狂欢、欢乐、高能氛围。

开关: 开启 / 关闭

亮度: 0% -100%

饱和度: 0%-100%

速度: 1-100

注: 根据需求滚动调节按钮设置当前参数值，设置完毕后短按并滚动调节按钮可跳入下一栏参数进行设置；选中手动时，通过短按一次调节按钮触发一次该光效；某个光效设置完毕后短按 MODE 按键回到 14 类光效选择界面。

菜单设置

短按 MENU 按键进入菜单界面，滚动调节按钮进行选择，选定后短按调节按钮进入该项的具体设置。



1. 蓝牙

短按调节按钮进入蓝牙设置，通过短按并滚动调节按钮设置开启或关闭；如需重置，滚动调节按钮到重置栏，短按调节按钮可选确定或取消，选定后短按调节按钮即可；下一栏可查看蓝牙 MAC 码，方便查找灯具。



“Godox Light”app 下载

扫描二维码即可下载“Godox Light”手机 app（安卓和苹果系统都可以使用）。

注：

1. 首个移动设备（手机或平板电脑）可直接使用 app 操控灯体。更换其他移动设备时，灯体需进行蓝牙重置方可正常使用 app。

2. app 需升级至 V3.0 以上版本。



“Godox Light”app 固件升级

手机中打开 Godox Light, 进入其中一个场景, 点击 + (添加设备), 设备添加完成后, 点击  延伸出多项设置, 再选择固件升级即可。



2. 风扇

短按调节按钮进入风扇设置, 通过滚动调节按钮可选静音 / 自动 / 中速 / 高速, 选定后短按调节按钮完成设置。



3. 屏幕设置

短按调节按钮进入屏幕设置, 通过滚动调节按钮设置 10%-100% 屏幕亮度。

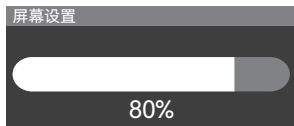

4. 语言

短按调节按钮进入语言设置，通过滚动调节按钮可选简体中文 /English，选定后短按调节按钮完成设置。

语言

简体中文

English

5. 快速开机

短按调节按钮进入快速开机设置，通过滚动调节按钮可选关闭或开启，选定后短按调节按钮完成设置；开启后，无需长按开关按键，接入电源即开机。

快速开机

关
开

6. 恢复出厂设置

短按调节按钮进入恢复出厂设置，通过滚动调节按钮可选确定 / 取消；短按调节按钮确定恢复出厂，灯具自动重启，界面出现简体中文和 English 选项，设置需要的语言后灯体亮度值自动变为 100%。

恢复出厂设置

确定

取消

7. 灯具信息

短按调节按钮进入灯具信息，此界面可查看如图示内容。

型号：ML100R

固件：V1.0

温度：29

照度数据

色温	测试条件	照度单位	1m	2m	3m
1800K	裸灯	lux	952	243	107
		fc	88	23	10
	搭配透镜反光杯 ML-L15	lux	5480	1520	700
		fc	509	142	65
2800K	裸灯	lux	2700	703	312
		fc	251	65	29
	搭配透镜反光杯 ML-L15	lux	14800	4110	1910
		fc	1380	382	177
3200K	裸灯	lux	2480	648	288
		fc	231	60	27
	搭配透镜反光杯 ML-L15	lux	13600	3750	1740
		fc	1260	348	162
4300K	裸灯	lux	2430	636	283
		fc	226	59	26
	搭配透镜反光杯 ML-L15	lux	13300	3690	1710
		fc	1240	342	159
5600K	裸灯	lux	2360	617	275
		fc	219	57	26
	搭配透镜反光杯 ML-L15	lux	12900	3570	1660
		fc	1200	331	154
6500K	裸灯	lux	2320	604	269
		fc	215	56	25
	搭配透镜反光杯 ML-L15	lux	12600	3500	1620
		fc	1170	325	151
8500K	裸灯	lux	2190	570	254
		fc	203	53	24
	搭配透镜反光杯 ML-L15	lux	11900	3280	1520
		fc	1110	305	142
10000K	裸灯	lux	2120	549	246
		fc	197	51	23
	搭配透镜反光杯 ML-L15	lux	11700	3210	1490
		fc	1080	298	139

色温	测试条件	照度单位	1m	2m	3m
R (红光)	裸灯	lux	346	90	41
		fc	32	8	4
	搭配透镜反光杯 ML-L15	lux	2020	563	262
		fc	188	52	24
G (绿光)	裸灯	lux	953	248	111
		fc	89	23	10
	搭配透镜反光杯 ML-L15	lux	5230	1440	670
		fc	486	134	62
B (蓝光)	裸灯	lux	280	72	33
		fc	26	7	3
	搭配透镜反光杯 ML-L15	lux	1590	440	206
		fc	147	41	19

以上数据均为平均值，非绝对值，以上测试皆在灯体 100%亮度下进行。

规格参数

型号	ML100R
DC 输入接口	20V \equiv 6A
	输入功率 \approx 110W
色温	1800K-10000K
调光范围	0%-100%
FX 光效	14 类
CRI	\approx 95
TLCI	\approx 95
控制方式	蓝牙 app 控制 / 灯体控制
蓝牙控制距离	30m
工作环境温度	-10°C ~ 40°C
裸灯尺寸	\approx 122mm*46mm*110mm
裸灯净重	\approx 465g

规格和参数如有变更, 恕不另行通知。

Safety Instructions and Attentions

First of all, as the most basic principle: This product is a professional lighting set equipment and should be used by professional lighting engineers or under the guidance of professionals. Basic safety attentions must always be followed during use, as follows:

1. Before use, please read and understand these instructions and attentions.
2. Professional lighting is prohibited for children. When children are near, parents or accompanying persons must supervise closely to prevent children from personal injury due to collision with lamps or private use of lamps.
3. This lighting product is not ordinary lighting product and cannot be used for general lighting. Anyone who has suffered eye damage or has sensitive eyes should avoid using this product.
4. When the lamp is on, it must be used with care. Do not touch high-temperature parts, such as LED lamp beads, to avoid burns.
5. When the lamp is on, it is forbidden to look directly at the lamp beads under any circumstances. Strong light should be used under the guidance of professional lighting engineers. Avoid prolonged exposure to strong light under any circumstances. If eye discomfort, please turn off the lamp in time, suspend use, and see a doctor immediately.
6. If the lamp bead is damaged or deformed by heat, stop using this equipment, and contact the manufacturer, service agent or qualified maintenance personnel to replace the lamp bead in time to avoid accidents.
7. Do not use damaged equipment or accessories, and wait for professional maintenance personnel to check and repair to confirm being normal before use.
8. During using, if the casing of this product is broken due to being dropped, squeezed or subjected to strong impact, please do not use it, so as to avoid electric shock injury due to contact with internal electronic components.
9. If an extension cord is required, please use an extension cord with a current rating greater than or equal to that of the equipment. If an extension cord is rated less than the equipment, overheating may result.
10. Some products have long power cords, please place the power cords properly and keep them in a safe place. Avoid contacting the power cord with overheating surfaces, avoid improper placement that could cause pulling damage, or trip on-site personnel. Please use the certified power cord from the original manufacturer. If the product is damaged by using a non-certified power cord, it will not be repaired by our factory.
11. Be sure to unplug equipment from the power outlet before cleaning and repairing. When not in use, do not pull the power cord to unplug the equipment. For normal power-off, please hold both ends of the plug of the equipment with your hands and pull the plug out of power outlet. This equipment needs to be connected to a grounded outlet.
12. This equipment is not waterproof, please keep it dry and do not immerse it in water or other liquids. The equipment should be installed in a dry and ventilated place, and avoid using it in rainy, humid, dusty or overheated environments. Do not place any objects on the lamp or let liquid flow into the lamp to avoid accidents.

13. Do not disassemble the product without permission. If the product fails, it must be checked and repaired by authorized maintenance personnel.

14. Before storing, make sure that the equipment has cooled down completely. For storage, unplug the power cord from the equipment. The equipment should be placed in the carrying case or in a ventilated dry place.

15. Do not place equipment near flammable and volatile solvents such as alcohol and gasoline.

16. Do not use accessories that are not recommended by our factory to avoid fire, electric shock or personal injury.

17. Please make sure to clean the glass of the lamp bead frequently and keep it clean, the glass may cause the glass to explode if it is adhered to mosquito carcasses or dark-colored organic stains; when cleaning the device, please do not use a wet cloth to wipe, please use a dry, soft cloth to wipe the dirt on the device.

18. This product complies with ROHS, CE and FCC certification, please refer to the relevant national standards for use and operation.

19. The safety instructions are formulated according to the strict testing of the factory, and the design and specifications of the equipment are subject to change without prior notice. For latest product information, please check the GODOX website and view latest electronic instruction.

20. One-year warranty period, accessories such as consumable batteries, adapters, power cords, etc. are not covered by this warranty.

21. If it is found that the equipment is repaired without authorization, the one-year warranty period will be cancelled and relevant fees will be charged for maintenance.

22. Machine failures caused by non-standard operation are not covered by the warranty.

23. Please pay attention to the high temperature on the surface shell of the lamp head when using, and do not touch it for a long time. The surface of the device will still have a high residual temperature after the end of work, please wait it to cool down before touching for a long time.

Keep these instructions!



Do not stare at the operating light source.

Foreword

Thank you for purchasing !

Godox's full color LED video light ML100R has 14 types of FX modes, square and portable size with 1/4" screw port on the bottom to compatible with most tripods on the market, built-in Bluetooth to enable wireless control, quite suitable for outdoor live streaming, indoor live streaming, video shooting and other scenes.

Names of Parts

1. Display
2. Power Switch/MENU Button
3. MODE Button
4. Select Dial (Rotate/Press)
5. Fan Vent
6. Mount Locking Pusher
7. Godox Mount
8. DC Input Port
9. USB-C Input Port
10. 1/4 " Port

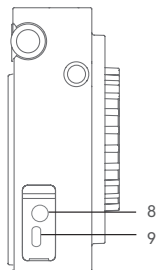
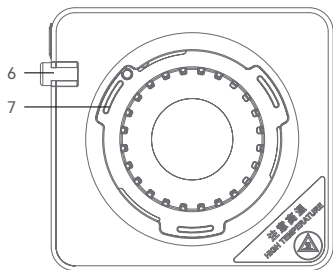
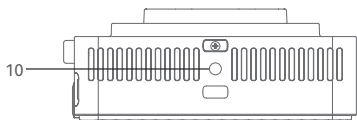
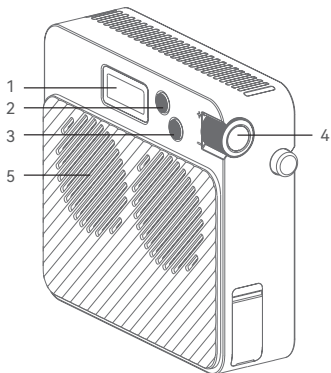

What's Inside ML100R L

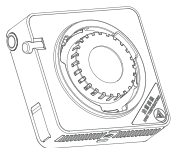

Light Body × 1

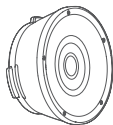

Lens Reflector ML-L15 × 1



Holder AD-E2 × 1



Instruction Manual × 1

What's Inside ML100R

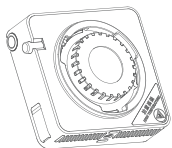

Light Body × 1

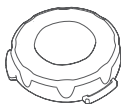

Protective Cover × 1



Lens Reflector ML-L15 × 1



Holder AD-E2 × 1

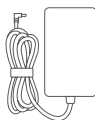

Adapter × 1



AC Power Cord × 1



Storage Bag × 1



Instruction Manual × 1

What's Inside ML100R Kit1

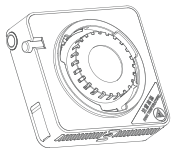

Light Body × 1

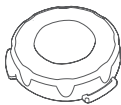

Protective Cover × 1

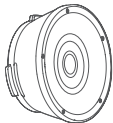

Lens Reflector ML-L15 × 1



Holder AD-E2 × 1

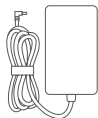

Adapter × 1



AC Power Cord × 1



Lens Reflector ML-L36 × 1

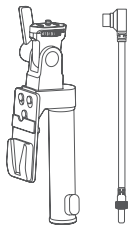

V-mount Battery
Accessory Kit AK-B02 × 1



Storage Bag × 1



Instruction Manual × 1

What's Inside ML100R Kit2

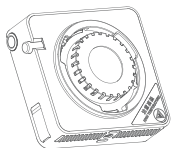

Light Body × 1

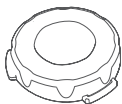

Protective Cover × 1

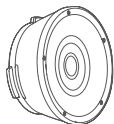

Lens Reflector ML-L15 × 1



Holder AD-E2 × 1

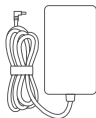

Adapter × 1



AC Power Cord × 1



Lens Reflector ML-L36 × 1

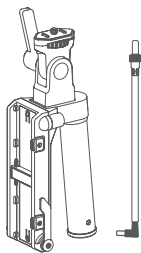

NP-F Battery Accessory Kit
AK-B01 × 1



Storage Bag × 1



Instruction Manual × 1

What's Inside ML100R Kit3

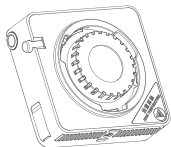

Light Body × 1

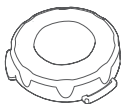

Protective Cover × 1

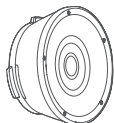

Lens Reflector ML-L15 × 1



Holder AD-E2 × 1

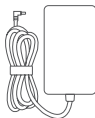

Adapter × 1



AC Power Cord × 1



Lens Reflector ML-L36 × 1

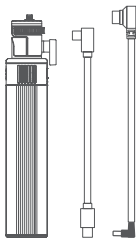

Godox Battery Grip BG02 × 1



Storage Bag × 1



Instruction Manual × 1

What's Inside ML100R Kit4

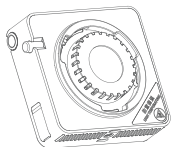

Light Body × 1

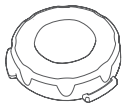

Protective Cover × 1

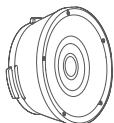

Lens Reflector ML-L15 × 1



Holder AD-E2 × 1

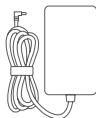

Adapter × 1



AC Power Cord × 1



Lens Reflector ML-L36 × 1

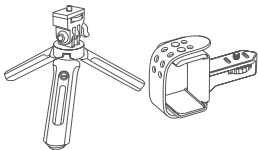

Fixing Holder Kit × 1



Storage Bag × 1



Instruction Manual × 1

Note: Due to continuous updates and upgrades of the products, there may be differences between the actual products and the pictures. Therefore, the pictures are for reference only, products to prevail in kind.

Separately Sold Accessories

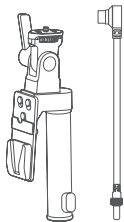

V-mount Battery Accessory Kit
AK-B02

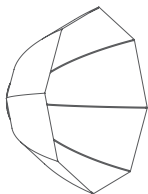

Octa Softbox
ML-SF50

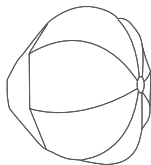

30cm Softbox
ML-CS30



60cm Softbox
AD-S60S



Lens Reflector
ML-L15



Lens Reflector
ML-L36



Godox to Bowens Mount
Adapter Ring ML-GB

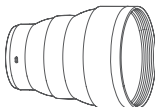

Collapsible Fresnel
Attachment ML-CFL5

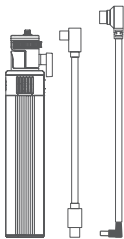

Godox Battery Grip
BG02

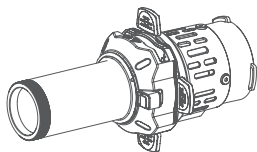

Godox-mount LED Projection
ML-SP-19°Kit

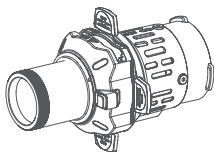

Godox-mount LED Projection
ML-SP-36°Kit

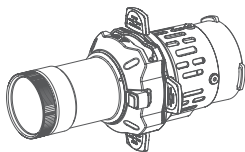

Godox-mount LED Projection
ML-SP-50°Kit

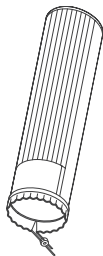

Air Soft Tube
ML-S1A

Install the Protection Cover/Lens Reflector

Align the protection cover or the lens reflector with the mount and rotate clockwise to install.

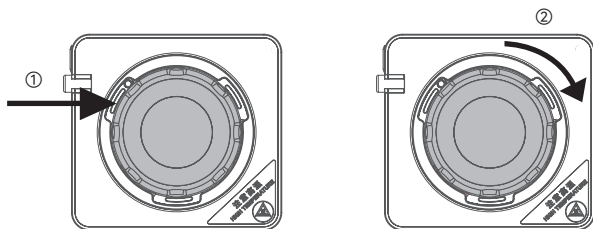

Install the Protection Cover

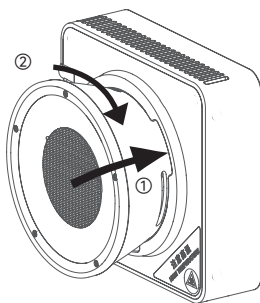

Install the Lens Reflector

Disassemble the Protection Cover/Lens Reflector

Press and hold the mount locking pusher and rotate counterclockwise to remove the protection cover or the lens reflector.

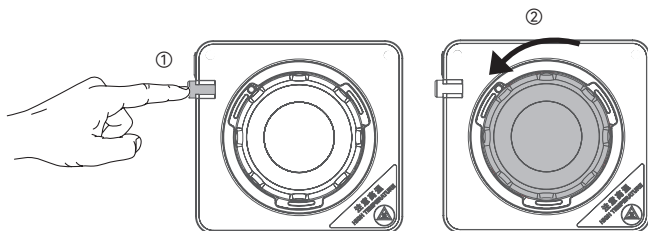

Disassemble the Protection Cover

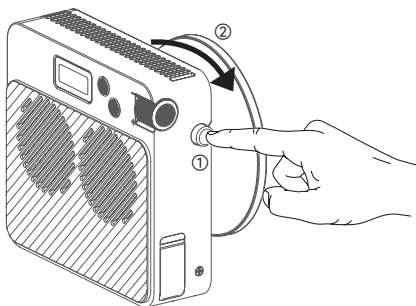

Disassemble the Lens Reflector

Note: Please take off the protection cover before turning on the light bead.

Power Supply

DC Power Supply: Connect the DC input port on the light body to AC power source with the adapter.

USB-C Power Supply: You can separately purchase a charging adapter or power bank not less than 18W, the output of which is determined by the charging adapter or power bank used.

Note: The adapter is separately sold for ML100R L.

Power Switch

Long press the power switch button after connected to power source to turn on or off the device. Turn on the quick boot function, it will automatically be turned on after connected to power source.

Mode Selection

Short press the MODE button to enter mode selection interface, rotate the select dial to select the desired mode, then press it to enter the corresponding parameter settings. Rotate the select dial clockwise to increase the parameters, while rotate anticlockwise to decrease the parameters.

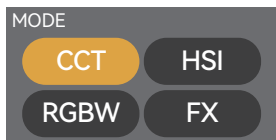

CCT Mode

Rotate and press the select dial to enter CCT mode, in which you can adjust the DIM/ CCT/GM.

DIM range: 0% -100%

CCT range: 1800K ~ 10000K

GM range: -100% ~ +100%

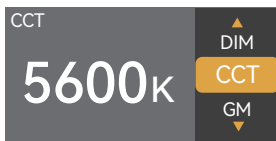

HSI Mode

Rotate and press the select dial to enter HSI mode, in which you can adjust the DIM/ HUE/SAT.

DIM range: 0% -100%

HUE range: 0° ~ 360°

SAT range: 0% ~ 100%

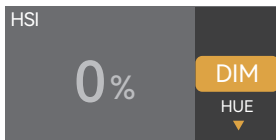

RGBW Mode

Rotate and press the select dial to enter RGBW mode, in which you can adjust the DIM/red/green/blue/white.

DIM range: 0% -100%

Red range: 0% ~ 100%

Green range: 0% ~ 100%

Blue range: 0% ~ 100%

White range: 0% ~ 100%

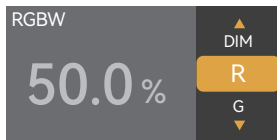

FX Mode

Rotate and press the select dial to enter FX mode, in which you can choose among the following 14 effects and adjust their respective parameters.

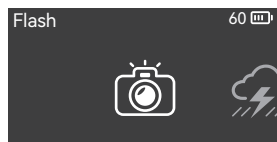

1. Flash

This light effect simulates the flash of a camera flash or a traditional flash bulb, often used to create a lively and dynamic atmosphere.

Switch: Turn on/off the effect

DIM: 0% -100%

Color: CCT/HSI

CCT/HUE: 1800K-10000K/0-360°

Speed: 1-100

Mode: Camera Flash/Flash Bulb

Trigger: Auto/Manual

2. Lightning

This effect simulates the natural thunder and lightning and is often used to create a tense, terrifying or mysterious atmosphere.

Switch: Turn on/off the effect

DIM: 0% -100%

CCT: 1800K-10000K

Times: Random/1-10

Frequency: Random /2-20

Trigger: Auto/Manual

3. Cloudy

This effect simulates the effect of cloud occlusion and is often used to create a gloomy, oppressive or sad atmosphere.

Switch: Turn on/off the effect

DIM: 0% -100%

Ratio: 30% -90%

Speed: Random/1-100

4. Broken Bulb

This effect simulates the effect of a broken bulb and is often used to create a dim atmosphere.

Switch: Turn on/off the effect

DIM: 0% -100%

Color: CCT/HSI

CCT/HUE: 1800K-10000K/0-360°

Speed: 1-100

5. TV

This effect simulates the effect of light from a television or screen and is often used to create a cold, mechanical or digital atmosphere.

Switch: Turn on/off the effect

DIM: 0% -100%

Color: CCT/HSI

Speed: 1-100

6. Candle

This effect simulates the effect of light from a candle and is often used to create a soft, warm, shimmering atmosphere.

Switch: Turn on/off the effect

DIM: 0% -100%

Speed: 1-100

7. Fire

This effect simulates the effect of light from flame and is often used to create a bright, warm, shimmering atmosphere.

Switch: Turn on/off the effect

DIM: 0% -100%

Speed: 1-100

8. Firework

This effect simulates the effect of light from fireworks and is often used to create a gorgeous, colorful, romantic atmosphere.

Switch: Turn on/off the effect

DIM: 0% -100%

Embers: 1-100

Speed: 1-100

9. Explosion

This effect simulates the effect of light from explosion and is often used to create a bright, fierce, shimmering atmosphere.

Switch: Turn on/off the effect

DIM: 0% -100%

Color: CCT/HSI

CCT/HUE: 1800K-10000K/0-360°

Embers: 1-100

Speed: 1-100

Trigger: Auto/Manual

10. Welding

This effect simulates the effect of light from welding and is often used to create a hot, mechanical atmosphere.

Switch: Turn on/off the effect

DIM: 0% -100%

Color: CCT/HSI

CCT/HUE: 1800K-10000K/0-360°

Speed: 1-100

11. Cop Car

This effect simulates the effect of light from cop car and is often used to create a tension, chasing atmosphere.

Switch: Turn on/off the effect

DIM: 0% -100%

Color: Red+Blue, Red, Blue, Blue+White, Blue+Yellow, Yellow, Red+White+Blue, Red+Yellow+Blue

Mode: 1-5

12. SOS SOS

This effect simulates the flashing effect of an SOS signal and is often used to create a dangerous, distress or emergency atmosphere.

Switch: Turn on/off the effect

DIM: 0% -100%

Color: CCT/HSI

CCT/HUE: 1800K-10000K/0-360°

13. RGB Cycle

This effect simulates the effect cycle and change of colorful lights and is often used to create a fantasy, sci-fi atmosphere.

Switch: Turn on/off the effect

DIM: 0% -100%

SAT: 0%-100%

Speed: 1-100

14. Party

This effect simulates the effect of colorful lights, flashes and laser, and is often used to create a carnival, fun, high energetic atmosphere.

Switch: Turn on/off the effect

DIM: 0% -100%

SAT: 0%-100%

Speed: 1-100

Note: Please rotate the select dial to adjust the parameters, then press and rotate it to the next parameter. Select manual, the effect can be triggered once by pressing the select dial once. After a certain effect is set, press MODE button can return to the 14 effects interface.

MENU Settings

Press the MENU button to enter menu interface, rotate and press the select dial to enter the following setting options.



1. Bluetooth

Short press the select dial to enter Bluetooth interface, press and rotate the select dial to Bluetooth to turn it on or off. If you need to reset the Bluetooth, rotate the select dial to reset and press it to choose between yes or no. The MAC code is on the left corner for quick check.

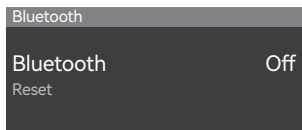

"GODOX Light" app Downloading

Scan the QR code to download the "Godox Light" smartphone app (can be used in Android and iOS).

Note:

1. The app can be used directly on the firstly installed device (smartphone or tablet). When change to other mobile device (smartphone or tablet), the light shall be reset before the normal connection of the app.
2. The app should be version 3.0 or above.



"GODOX Light" app Firmware Upgrade

Open Godox Light, enter a certain scene and click "+" to add a fixture, then click  to display more settings, choose firmware upgrade.

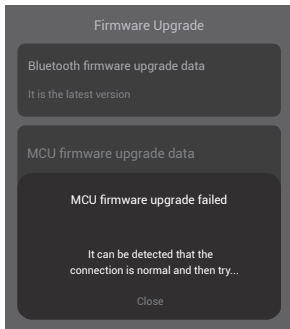

2. Fan

Short press the select dial to enter fan interface. Rotate and short press the select dial choose among off, auto, medium and high.



3. Display

Short press the select dial to enter display interface, press and rotate the select dial to adjust the display brightness from 10% to 100%.

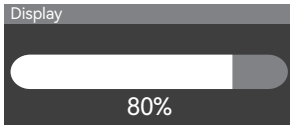

4. Language

Short press the select dial to enter language interface, press and rotate the select dial to choose between simplified Chinese and English.

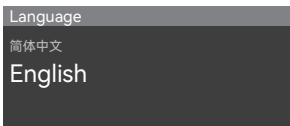

5. Quick Boot

Short press the select dial to enter quick boot interface, press and rotate the select dial to choose between simplified off and on. Turn on the quick boot function, it will automatically be turned on after connected to power source.

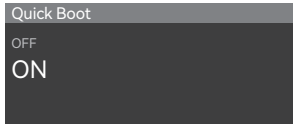

6. Factory Reset

Short press the select dial to enter factory reset interface to choose yes or no. If you choose yes, the device will automatically reset and reboot, then simplified Chinese and English options show on the display for your choice, after which the brightness will turn to 100% automatically.

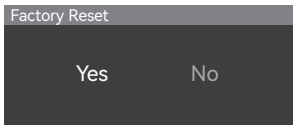

7. Fixture Info

Short press the select dial to enter fixture info interface to check the detailed fixture information.

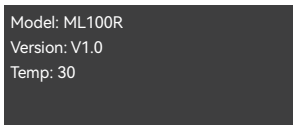

Illuminance Data

CCT	Testing Condition	Unit	1m	2m	3m
1800K	Bare Light	lux	952	243	107
		fc	88	23	10
	With Lens Reflector ML-L15°	lux	5480	1520	700
		fc	509	142	65
2800K	Bare Light	lux	2700	703	312
		fc	251	65	29
	With Lens Reflector ML-L15°	lux	14800	4110	1910
		fc	1380	382	177
3200K	Bare Light	lux	2480	648	288
		fc	231	60	27
	With Lens Reflector ML-L15°	lux	13600	3750	1740
		fc	1260	348	162
4300K	Bare Light	lux	2430	636	283
		fc	226	59	26
	With Lens Reflector ML-L15°	lux	13300	3690	1710
		fc	1240	342	159
5600K	Bare Light	lux	2360	617	275
		fc	219	57	26
	With Lens Reflector ML-L15°	lux	12900	3570	1660
		fc	1200	331	154
6500K	Bare Light	lux	2320	604	269
		fc	215	56	25
	With Lens Reflector ML-L15°	lux	12600	3500	1620
		fc	1170	325	151
8500K	Bare Light	lux	2190	570	254
		fc	203	53	24
	With Lens Reflector ML-L15°	lux	11900	3280	1520
		fc	1110	305	142
10000K	Bare Light	lux	2120	549	246
		fc	197	51	23
	With Lens Reflector ML-L15°	lux	11700	3210	1490
		fc	1080	298	139

CCT	Testing Condition	Unit	1m	2m	3m
R (Red)	Bare Light	lux	346	90	41
		fc	32	8	4
	With Lens Reflector ML-L15"	lux	2020	563	262
		fc	188	52	24
G (Green)	Bare Light	lux	953	248	111
		fc	89	23	10
	With Lens Reflector ML-L15"	lux	5230	1440	670
		fc	486	134	62
B (Blue)	Bare Light	lux	280	72	33
		fc	26	7	3
	With Lens Reflector ML-L15"	lux	1590	440	206
		fc	147	41	19

Note: All the data are average values instead of absolute values. All the above tests are based on the condition of 100% brightness.

Technical Data

Model	ML100R
DC Input Port	20V $\overline{=}$ 6A
	Input Power \approx 110W
CCT	1800K-10000K
Brightness Range	0%-100%
FX Mode	14
CRI	\approx 95
TLCI	\approx 95
Controlling Methods	Bluetooth app/light body control
Bluetooth Controlling Distance	30m
Working Environment Temperature	-10°C ~ 40°C
Dimension of Bare Light	\approx 4.8"*1.81"*4.33"
Net Weight of Bare Light	\approx 465g

Specifications and data may subject to changes without notice.

FCC Statement

This device complies with part 15 of the FCC Rules. Operation is subject to the following two conditions:

- (1) This device may not cause harmful interference, and
- (2) this device must accept any interference received, including interference that may cause undesired operation.

Any Changes or modifications not expressly approved by the party responsible for compliance could void the user's authority to operate the equipment.

Note: This equipment has been tested and found to comply with the limits for a Class B digital device, pursuant to part 15 of the FCC Rules. These limits are designed to provide reasonable protection against harmful interference in a residential installation. This equipment generates uses and can radiate radio frequency energy and, if not installed and used in accordance with the instructions, may cause harmful interference to radio communications. However, there is no guarantee that interference will not occur in a particular installation. If this equipment does cause harmful interference to radio or television reception, which can be determined by turning the equipment off and on, the user is encouraged to try to correct the interference by one or more of the following measures:

- Reorient or relocate the receiving antenna.
- Increase the separation between the equipment and receiver.
- Connect the equipment into an outlet on a circuit different from that to which the receiver is connected.
- Consult the dealer or an experienced radio/TV technician for help.

The device has been evaluated to meet general RF exposure requirement.

The device can be used in portable exposure condition without restriction.

IC Warning

Le présent appareil est conforme aux CNR d'Industrie Canada applicables aux appareils radio exempts de licence. L'exploitation est autorisée aux deux conditions suivantes:

- (1) l'appareil ne doit pas produire de brouillage, et
- (2) l'utilisateur de l'appareil doit accepter tout brouillage radioélectrique subi, même si le brouillage est susceptible d'en compromettre le fonctionnement

Tout changement ou modification non expressément approuvé par la partie responsable de la réglementation de l'OCDE peut faire perdre à l'utilisateur le droit d'utiliser l'appareil.

Remarque: cet appareil a été testé pour répondre aux limites des appareils numériques de classe B conformément à la partie 15 des règles de la Federal Communications

Commission des États - Unis. Ces limites sont conçues pour fournir une protection raisonnable contre les interférences nuisibles dans les installations résidentielles. L'appareil génère de l'énergie RF utilisée et rayonne, ce qui peut causer des interférences nocives pour les communications radio s'il n'est pas installé et utilisé conformément aux instructions. Cependant, aucune Garantie contre les interférences dans une installation spécifique. Si l'appareil cause des interférences nuisibles à la réception de la radio ou de la télévision, qui peuvent être déterminées en éteignant et en allumant l'appareil, l'utilisateur est encouragé à tenter de corriger les interférences par une ou plusieurs des mesures suivantes:

- redirection ou repositionnement de l'antenne de réception.
- augmenter l'espacement entre l'appareil et le récepteur.
- Connecter l'appareil à une prise sur un circuit différent de celui auquel le récepteur est connecté.
- consultez votre revendeur ou un technicien radio / tv expérimenté pour obtenir de l'aide.

Avertissement RF pour les appareils portables:

L'appareil a été évalué pour répondre aux exigences générales d'exposition aux radiofréquences. Équipement Peut être utilisé sans restriction dans des conditions d'exposition portables.

Warning

Operating frequency:2402MHz – 2480MHz(BT)

Maximum EIRP Power: 5dBm(BT)

Declaration of Conformity

GODOX Photo Equipment Co.,Ltd. hereby declares that this equipment are in compliance with the essential requirements and other relevant provisions of Directive 2014/53/EU. In accordance with Article 10(2) and Article 10(10), this product is allowed to be used in all EU member states.For more information of DoC, Please click this web link:

<https://www.godox.com/eu-declaration-of-conformity/>

The device complies with RF specifications when the device used at 0mm from your body.

产品保修

尊敬的用户，本保修卡是申请保修服务的重要凭证，请您配合销售商填写并妥善保管，谢谢！

产品信息	型号	产品条码
用户信息	姓名	联系电话
	通信地址	
销售商信息	名称	
	联系电话	
	通信地址	
	销售日期	
备注		

注：此表应由销售商盖章确认。

产品信息

本文件适用于相关《产品保修信息》(见后面说明)所列产品,其他非属此范围的产品或部件(如促销品、赠品及其他出厂后附加的部件等)不在此保修承诺内。

保修期

产品及部件的相应保修期按相关的《产品保修信息》执行。保修期自产品首次购买日起算，购买日以购买产品时保修卡登记日期为准。

如何获得保修服务

您可直接与产品销售商或授权服务机构联系，也可拨打神牛产品售后服务电话，与我们联系，由我们的服务人员为您安排服务。申请保修时，您应提供有效的保修卡作为保修凭证，方可获得保修。如您不能提供有效的保修卡，则在我们确认产品或部件属于保修范围的情况下，也可以为您提供保修，但这不作为我们的义务。

不适用保修情况

如产品存在下列情况，本文件项下的保证和服务将不适用：①产品或部件超过相应保修期；②错误或不当使用、维护或保管导致的故障或损坏，如：不当搬运；非按产品合理预期用途使用；不当插拔外接设备；跌落或外力挤压；接触或暴露于不适当温度、溶剂、酸碱、水浸或潮湿环境；③由非神牛授权机构或人员安装、修理、更改、添加或拆卸造成的故障或损坏；④产品或部件原有识别信息被修改变更或删除；⑤无有效保修卡；⑥使用非合法授权、非标准或非公开发行的软件造成的故障或损坏；⑦因不可抗力或意外事件造成的故障或损坏；⑧其他非因产品本身质量问题导致的故障或损坏。遇上述情况，您应向相关责任方寻求解决，神牛对此不承担任何责任。因非在保修期或保修范围内的部件、附件或软件导致产品不能正常使用的，不是保修范围内的故障。产品使用过程中正常的脱色、磨损和消耗，不是保修范围内的故障。

产品保修和服务支持信息

产品的保修期和服务类型按以下《产品保修信息》执行：

产品类别	选件名称	保修期（月）	保修服务类型
带电性能的部件	灯体内部元器件	12	客户送修
其他	灯头保护罩、透镜反光杯、 支架、适配器、线材、或包装	无	无保修

神牛产品售后服务电话 0755-29609320-8062

Warranty

Dear customers, as this warranty card is an important certificate to apply for our maintenance service, please fill in the following form in coordination with the seller and safe-keep it. Thank you!

Product Information	Model	Product Code Number
Customer Information	Name	Contact Number
	Address	
Seller Information	Name	
	Contact Number	
	Address	
	Date of Sale	
Note		

Note: This form shall be sealed by the seller.

Applicable Products

Applicable Products The document applies to the products listed on the Product Maintenance Information (see below for further information). Other products or accessories (e.g. promotional items, giveaways and additional accessories attached, etc.) are not included in this warranty scope.

Warranty Period

The warranty period of products and accessories is implemented according to the relevant Product Maintenance Information. The warranty period is calculated from the day (purchase date) when the product is bought for the first time, and the purchase date is considered as the date registered on the warranty card when buying the product.

How to Get the Maintenance Service

If maintenance service is needed, you can directly contact the product distributor or authorized service institutions. You can also contact the Godox after-sale service call and we will offer you service. When applying for maintenance service, you should provide valid warranty card. If you cannot provide valid warranty card, we may offer you maintenance service once confirmed that the product or accessory is involved in the maintenance scope, but that shall not be considered as our obligation.

Inapplicable Cases

The guarantee and service offered by this document are not applicable in the following cases: ① The product or accessory has expired its warranty period; ② Breakage or damage caused by inappropriate usage, maintenance or preservation, such as improper packing, improper usage, improper plugging in/out external equipment, falling off or squeezing by external force, contacting or exposing to the improper temperature, solvent, acid, base, flooding and damp environments, etc; ③ Breakage or damage caused by non-authorized institution or staff in the process of installation, maintenance, alternation, addition and detachment; ④ The original identifying information of product or accessory is modified, alternated, or removed; ⑤ No valid warranty card; ⑥ Breakage or damage caused by using illegally authorized, nonstandard or non-public released software; ⑦ Breakage or damage caused by force majeure or accident; ⑧ Breakage or damage that could not be attributed to the product itself. Once met these situations above, you should seek solutions from the related responsible parties and Godox assumes no responsibility. The damage caused by parts, accessories and software that beyond the warranty period or scope is not included in our maintenance scope. The normal discoloration, abrasion and consumption are not the breakage within the maintenance scope.

Maintenance and Service Support Information

The warranty period and service types of products are implemented according to the following Product Maintenance Information:

Product Type	Name	Maintenance Period(month)	Warranty Service Type
Parts	Light body internal components	12	Customer sends the product to designated site
Other Items	Accessories without electrical properties: protection cover, lens reflector, adapter, cable, package, etc.	No	Without warranty

Godox After-sale Service Call +86-755-29609320(8062)