

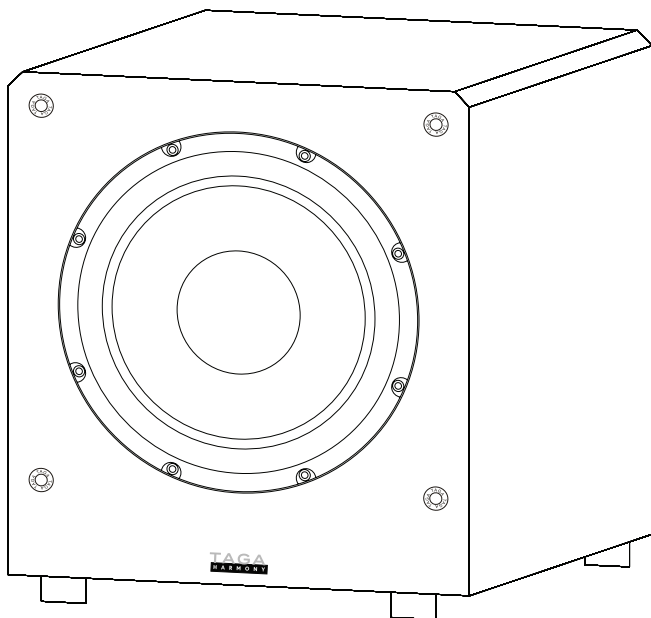

TAGA
H A R M O N Y

Active Subwoofers

TSW-212 / TSW-210 / TSW-90 v.4 / TSW-80 / TSW-60



Instruction Manual

Introduction

Thank you for purchasing this TAGA Harmony subwoofer.

This subwoofer is a single-driver and rear bass port construction with a built-in high-current amplifier.

The built-in amplifier delivers big power output and is characterized by high efficiency and current drive which results in low distortions, smooth and flat response and fast amp operation with significantly reduced operation noises. An integrated clipping limiter maintains the best performance and safe operation of the amp and bass driver even at extremely high volume levels.

The bass driver may operate in high amplitude ranges and quickly reacts on any changes in the audio signal structure.

The removable IEC power cable gives an option to upgrade your subwoofer with a premium audiophile power cable in any time.

The TSW subwoofers deliver the most powerful, deep bass with staggering definition, location and dynamics never met at this price level before.

This subwoofer is an ideal partner for your sound system.

Cleaning

Do not use strong or abrasive cleaners. Use a damp, soft cloth for cleaning.

Specifications and the latest instruction manual edition

Full technical specifications and the latest edition of the instruction manual are available on **www.TagHarmony.com**.

Contents

Introduction	2
Safety Instructions	4
Unpacking the Subwoofer	6
Placement	6
Controls and Connections - Rear Panel	7
Hooking Up The Subwoofer	8
Operation	11
Additional Information	13

Safety Instructions

IMPORTANT
READ THIS SECTION CAREFULLY BEFORE PROCEEDING!



CAUTION

RISK OF ELECTRIC SHOCK
DO NOT OPEN



WARNING: TO REDUCE THE RISK OF FIRE OR ELECTRIC SHOCK, DO NOT EXPOSE THIS PRODUCT TO RAIN OR MOISTURE. DO NOT REMOVE COVER (OR BACK). NO USER-SERVICEABLE PARTS INSIDE. REFER SERVICING TO QUALIFIED SERVICE PERSONNEL.



The triangle containing a lightning symbol is intended to alert the user to the presence of uninsulated dangerous voltages within the product's enclosure that may be of sufficient magnitude to constitute a risk of electric shock to persons.



An exclamation mark in a triangle is intended to alert the user to the presence of important operating and maintenance (servicing) instructions in the literature accompanying the appliance.

WARNING: TO REDUCE THE RISK OF FIRE OR ELECTRIC SHOCK, DO NOT EXPOSE THIS APPARATUS TO RAIN OR MOISTURE, AND OBJECTS FILLED WITH LIQUIDS, SUCH AS VASES, SHOULD NOT BE PLACED ON THIS APPARATUS.

CAUTION: TO PREVENT ELECTRIC SHOCK, FULLY AND SECURELY INSERT THE POWER CABLE PLUG INTO THE POWER OUTLET, AND POWER CABLE CONNECTOR INTO THE UNIT SOCKET (IF THIS UNIT IS NOT EQUIPPED WITH AN INTEGRATED [ATTACHED] POWER CORD).

CAUTION: FOR CONTINUED PROTECTION AGAINST RISK OF FIRE, REPLACE THE FUSE (IF THE UNIT IS EQUIPPED WITH A USER REPLACEABLE FUSE) ONLY WITH THE SAME AMPERAGE AND VOLTAGE TYPE. IN CASE WHEN THE UNIT IS NOT EQUIPPED WITH A USER REPLACEABLE FUSE - REFER REPLACEMENT TO QUALIFIED SERVICE PERSONNEL.

WARNING: THE UNIT MAY BECOME HOT. ALWAYS PROVIDE ADEQUATE VENTILATION TO ALLOW FOR COOLING. DO NOT PLACE THE UNIT NEAR A HEAT SOURCE, OR IN SPACES THAT CAN RESTRICT VENTILATION.

Safety Instructions

1. Read Instructions - All the safety and operating instructions should be read before the product is operated.
2. Retain Instructions - The safety and operating instructions should be retained for future reference.
3. Heed Warnings - All warnings on the product and in the operating instructions should be adhered to.
4. Follow Instructions - All operating and use instructions should be followed.
5. Cleaning - Unplug this product from the power outlet before cleaning. Do not use liquid cleaners or aerosol cleaners.
6. Water and Moisture - Do not use this product near water - for example, near a bath tub, wash bowl, kitchen sink or laundry tub; in a wet basement; or near a swimming pool; and the like. These precautions also apply to the power cord.
7. Accessories - Do not place this product on an unstable cart, stand, tripod, bracket or table. The product may fall, causing serious injury to a child or adult and serious damage to the product. Use only with a cart, stand, tripod, bracket or table recommended by the manufacturer or sold with the product. Any mounting of the product should follow manufacturer's instructions and should use a mounting accessory recommended by the manufacturer.
8. Ventilation - This unit may be equipped with slots and openings in the cabinet (housing) which are provided for ventilation and to ensure reliable operation of the product and to protect it from overheating and these openings must not be blocked or covered. The openings should never be blocked by placing the product on a bed, sofa, rug or other similar surface. This product should be not placed in a built-in installation such as a bookcase or rack unless proper ventilation is provided or the manufacturer's instructions have been adhered to. For products equipped with a separate power supply unit, leave at least 5cm (2in.) of free space on all sides and the top of the power supply.
9. Power Sources - This product should be operated only from the type of power source indicated on the marking label (placed on the product and/or, if applicable, on a separate power supply unit). If you are not sure of the type of power supply in your home, consult your product dealer or local power company. For products intended to operate from battery power or other sources, refer to the operating instructions.
10. Grounding and Polarity - some units for proper operation or to take full advantage of their capabilities may require to be connected to a grounded power outlet - refer to the user manual for more information. Some units may have markings for the live (L) and neutral (N) conductors for power - in order to take full advantage of capabilities of such products, it is recommended to properly connect the polarity according to the markings on the unit - refer to the user manual for more information. Connecting the polarity not in accordance with the markings will not affect the durability and reliability of the device.
11. Power-cord Protection - Power supply cords should be routed so that they are not likely to be walked on or pinched by items placed upon or against them, paying particular attention to cords at plugs, convenience receptacles and the point where they exit from the product.
12. Lighting - For added protection for this product during a lighting storm or when it is left unattended and unused for long periods of time, unplug it from the wall outlet and disconnect the antenna or system cables. This will prevent damage to the product due to lighting and power-line surges.
13. Overloading - Do not overload wall outlets, extension cords or integral convenience receptacles as this can result in a risk of fire or electric shock.
14. Object and Liquid Entry - Never push objects of any kind into this product through openings as they may touch dangerous voltage points or short-out parts that could result in a fire or electric shock. Do not expose this apparatus to dripping or splashing and ensure that no objects filled with water, such as vases are placed on the apparatus.
15. Servicing - Do not attempt to service this product yourself as opening or removing covers may expose you to dangerous voltage or other hazards. Refer all servicing to qualified service personnel.
16. Damage Requiring Service - Unplug this product from wall outlet and refer servicing to qualified personnel under the following conditions:
 - when power supply cord or plug is damaged;
 - if liquid has been spilled or objects have fallen into the product;
 - if the product does not operate normally by following the operating instructions. Adjust only those controls that are covered by the operating instructions as an improper adjustment of other controls may result in damage and will require extensive work by a qualified technician to restore the product to its normal operation;
 - if the product has been dropped or damaged in any way;
 - if the product exhibits a distinct change in performance - this indicates a need for a service.
17. Replacement Parts - when replacement parts are required, be sure the technician has used replacement parts specified by the manufacturer or with the same characteristics as the original part. Unauthorized substitutions may result in fire, electric shock or other hazards.
18. Safety Check - Upon completion of any service or repairs to this product, ask the service technician to perform safety check to determine that the products is in proper operating condition.
19. Wall of ceiling mounting - The product should be mounted to a wall or ceiling only as recommended by the manufacturer.
20. Heat - The product should be situated away from heat sources such as radiators, heat registers, stoves or other products (including amplifiers) that produce heat.
21. [Refers to products equipped with vacuum tubes] Tube Cage or cover - For your safety and to protect the vacuum tubes this product may be equipped with the factory installed vacuum tube cage or cover. It is not recommended to remove the cage or cover unless it is required to change the vacuum tubes. When the cage or cover is removed - do not touch the vacuum tubes - they may be hot and burn the skin!
22. Operating Environment - Operating environment temperature and humidity of the unit: +5°C to +35°C (+41°F to +95°F); less than 85% RH (cooling slots not blocked).



PACKAGING WARNING

The packaging may contain elements such as plastic, that **should be kept away from small children.**

The thin foil or small elements can stick to the nose and mouth, or may be swallowed and prevent breathing.

Unpacking the subwoofer

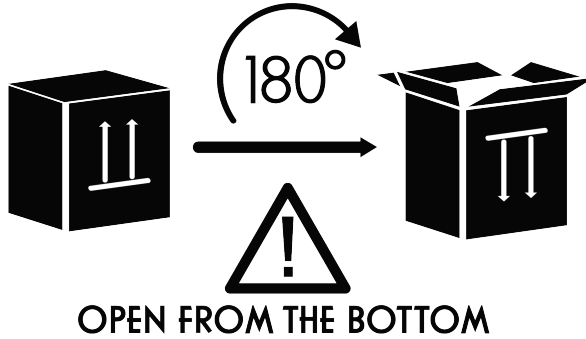

Place the carton with the subwoofer on the floor in the upside down position and open it from the bottom, remove the internal packaging which protects the subwoofer on the bottom. Carefully turn the carton with the subwoofer upside down. When the subwoofer is securely placed on the floor remove the carton and internal packaging - your subwoofer is ready for placement in your room.

Placement

The placement of the subwoofer in the room is not so critical as for speakers but there are general guidelines as shown below:



Placing the subwoofer in the center of the room usually gives less bass but with better precision and definition.

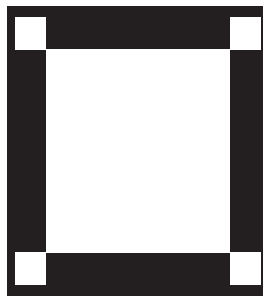

Placing the subwoofer near the walls usually gives more bass with quite good precision and definition.

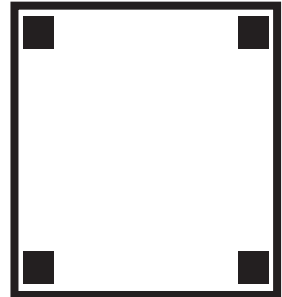

Placing the subwoofer in the corners usually gives much amount of bass but with less precision and definition.

Note! If it is possible we recommend to place the subwoofer between the front speakers close to the wall for better integration with your sound system.

Note! Final placement depends on your sound system, room acoustics and space, and your listening preferences.

Controls and Connections - Rear Panel

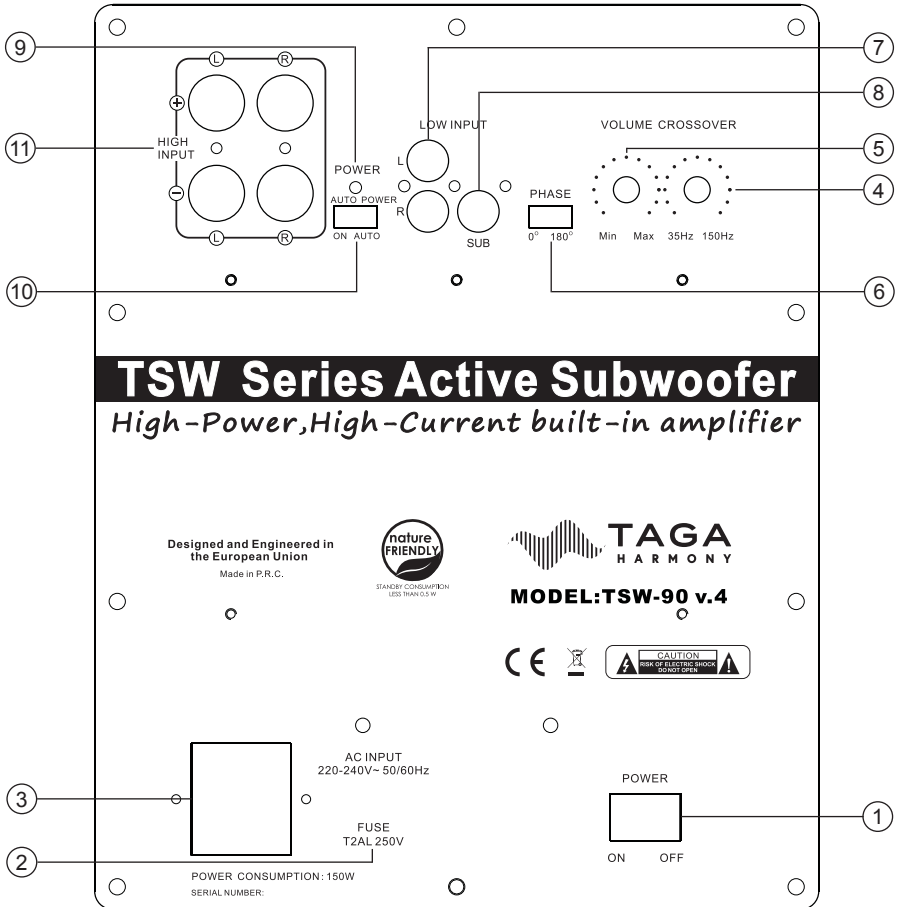

Available controls and inputs as well as their placement on the rear panel may vary depending on the model. The above figure shows the TSW-90 v.4 subwoofer rear panel.

Rear Panel:

1. Power Switch (ON and OFF)
2. Fuse

A blown fuse should be only exchanged for exactly the same type as indicated on the rear subwoofer panel. The Power Cable should be disconnected!

3. Power Cable Input
4. Crossover Regulator
5. Volume Regulator
6. Phase Switch
7. Low Input: Left and Right
8. Low Input: Sub
9. Power Status LED Indicator
10. Auto Power Switch (ON and AUTO)
11. High Input Speaker Connectors (Left and Right)

Hooking Up The Subwoofer



Check „Kit Content” for a list of cables supplied with this product.



Before connecting make sure that your subwoofer and audio equipment are turned off - otherwise you may damage this subwoofer and/or audio equipment. This may void your warranty.

1. Make sure the subwoofer is turned off (the Power Switch is in the OFF position and the Power Cable is removed from the wall outlet).
2. Make sure that your audio equipment (amplifier/preamplifier/AV receiver) is turned off.
3. Turn the Volume Regulator to MIN (max counter clockwise).
4. Choose one of the following connection methods:

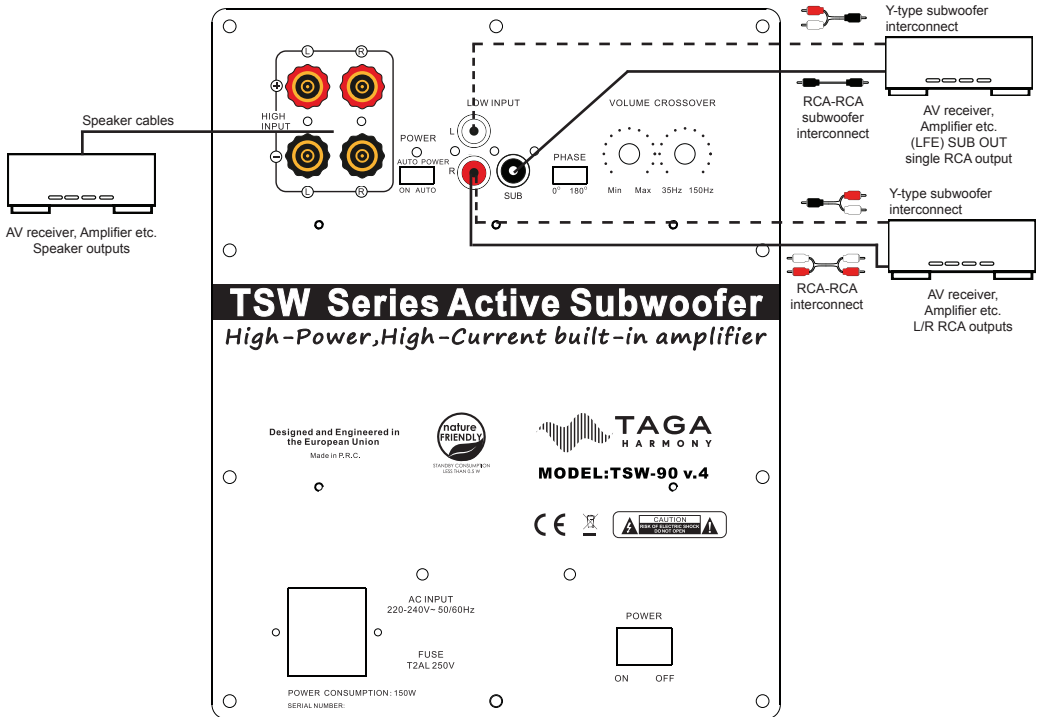

Hooking Up The Subwoofer

I. CONNECT USING LFE (SUB OUT) SUBWOOFER OUTPUT

This connection is recommended if your audio equipment is equipped with a single filtered RCA subwoofer output (usually marked as LFE, SUB OUT, SUBWOOFER etc.).

There are 2 options of connection:

- a. Using a single RCA subwoofer cable - connect the LFE output with the SUB Input on the rear panel.
- b. Using an Y-type subwoofer cable (1xRCA to 2xRCA) - connect the 1xRCA plug to the LFE output and the 2xRCA plugs to the Left and Right Low Input on the rear panel.



The Y type connection increases the bass output of the subwoofer by a few decibels.

II. CONNECT USING STEREO RCA OUTPUT (L/R)

If your audio equipment is not equipped with a filtered LFE (SUB OUT) subwoofer output then you can use regular stereo RCA outputs (non-filtered).

There are 2 options of connection:

- a. Using a pair of RCA subwoofer cable - connect the L/R RCA outputs of your audio equipment to the Left and Right Low Input on the rear panel.
- b. Using an Y-type subwoofer cable (1xRCA to 2xRCA) - connect the 2xRCA plugs to the L/R RCA outputs of your audio equipment and the 1xRCA plug to the Left or Right Low Input on the rear panel.

III. CONNECT USING SPEAKER OUTPUTS

You can use regular speaker cables to connect the subwoofer with your audio equipment – this process is the same as connecting stereo speakers.

Using the speaker cables connect speaker output connectors located on your audio equipment to the High Input Speaker Connectors (Left and Right) on the rear panel.

Pay attention to connecting the polarity of the audio equipment correctly with the subwoofer in each speaker connector group (the subwoofer should be connected RED + with RED + audio equipment connector, BLACK – with BLACK – audio equipment connector).



Do not let bare speaker wires touch each other or any metal part of this unit, it can damage this subwoofer and/or audio equipment.
This may void your warranty.









Please refer to your audio equipment instruction manual for more information about hooking up speaker cables.

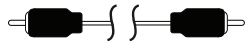

The CROSSOVER adjustment is not active with the Low Input Sub.
All adjustments and filtering of the signal should be set in the audio equipment configuration.

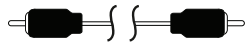
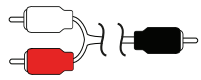
5. Your subwoofer is ready for operation.

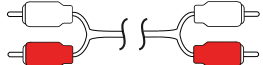
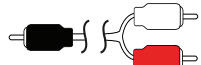
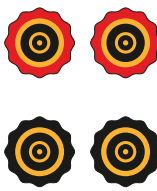
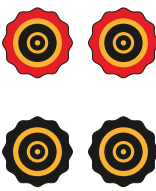
External audio equipment connection options:

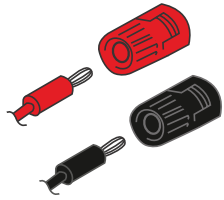
Input subwoofer	Output external equipment	Connection cable
<p>SUB</p> 	<p>(LFE) SUB OUT</p> 	<p>RCA-RCA subwoofer interconnect (supplied)</p> 
<p>L/R</p> 	<p>(LFE) SUB OUT</p> 	<p>RCA-RCA subwoofer interconnect (supplied)</p>  <p>or</p> <p>Y-type subwoofer interconnect (not supplied)</p> 
<p>L/R</p> 	<p>L/R RCA outputs</p> 	<p>RCA-RCA interconnect (not supplied)</p>  <p>or</p> <p>Y-type subwoofer interconnect (not supplied)</p> 
<p>HIGH INPUT</p> 	<p>SPEAKERS OUTPUT</p> 	<p>Speaker cables (not supplied) (connection shown for 1 channel) Bare wire</p>  <p>Terminated with banana plugs</p> 

The sockets shown for external equipment and connection options may differ depending on the device.

Operation

1. Plug the Power Cable to the subwoofer and into the electrical outlet.

2. Turn on the subwoofer – press the Power Switch to the ON position.

The Power Status LED Indicator will be flashing for a few seconds and then it should be illuminated continuously.

If it does not, it means that the subwoofer is working under in abnormal condition (a protection mode) – turn off the power, unplug the Power Cable and check whether some of the cables are not short circuited.

After fixing the cables turn the subwoofer on.

Note! Check “Additional Information” for other useful operating instructions.



High volume levels may damage this subwoofer. This may void your warranty.

VOLUME Regulator:

Using the Volume Regulator on the rear panel you can adjust the sound volume from minimum (the knob – max counterclockwise) to maximum (the knob – max clockwise).



Distortion and sound quality worsening may occur when the knob is in the maximum position. It may damage the subwoofer. This may void your warranty.

AUTO POWER Switch (selected models):

Certain models may be equipped with the auto audio signal detection feature.

When the subwoofer is turned on choose one of the two operating modes:

Auto Power (ON) – when the Power Switch is in the ON position, the subwoofer will remain continuously turned on. The Power Status LED Indicator will be illuminated continuously.

Auto Power (AUTO) – when the Power Switch is in the ON position:

- If no input audio signal is detected for a certain period of time the subwoofer will go into the standby mode. The Power Status LED Indicator will be flashing.
- If the subwoofer receives the input audio signal it will automatically go out of the standby mode and will start working. The Power Status LED Indicator will be illuminated continuously.



If the input audio signal is too weak, the Auto Power (AUTO) mode may not operate properly - try to increase the subwoofer output level in your audio equipment settings or use the Auto Power (ON) mode.



The time necessary to turn on and off the Auto Power (AUTO) mode may vary on the input audio signal strength and the time of the subwoofer's activity.

Operation

CROSSOVER Regulator:

This control is active only for: Low Input L and R, High Input Speaker Connectors (L and R).

The regulator allows the adjustment of the low-pass filter and affects the upper frequency limit of the subwoofer. The adjustment can be smoothly made between the frequency ranges which are provided on this regulator description on the rear panel. After it is set it will determine the highest frequency that the subwoofer will reproduce.

The best results are achieved when adjustments are done by ear - adjust the Crossover Regulator until the frequency range of the subwoofer blends well with that of the front speakers and the rest of the system.

Setting the crossover at the too low level will create a gap between the frequency of the front speakers and the subwoofer. Setting the crossover frequency too high will cause that certain frequencies will be duplicated or offset.



Using the CROSSOVER regulator at high volume levels may damage this subwoofer. This may void your warranty.

PHASE Switch:

The Phase Switch helps to fully and coherently integrate the subwoofer with the rest of your audio system. When you hear that the subwoofer bass is weak or offset, it may mean that the subwoofer works out-of-phase – try to change the phase using this switch.

Additional Information

Break-In

Your TAGA Harmony subwoofer sounds great immediately after it is taken out of the carton, but the internal components of this subwoofer require a “break-in” period to reach its full sonic capabilities.

During the “break-in” period it is recommended to operate the subwoofer at moderate volume levels.

The first level of the “break-in” is reached after approximately 10 hours of play.

The optimal level of the “break-in” is reached after approximately 40 to 60 hours of play.

Turn off procedure

Make sure to turn off the subwoofer first when powering down your system.



If the subwoofer was turned off even for a short period of time, you should wait at least 2 minutes before turning it back on.
Do not turn it ON then OFF and then ON again in quick succession.

Follow this procedure each time you turn your subwoofer OFF / ON.

This precaution will minimize the stress (high voltages) on internal components.



It is recommended to turn off the subwoofer when you intend not to use it for a longer period of time.

Noise floor

It is a normal phenomenon that a built-in amplifier may produce some amount of noise (called noise floor or self-noise) which can be audible in the subwoofer driver.

Power transformer – Power filters and conditioners

It is a normal phenomenon that the device’s power transformer may generate a certain amount of audible noise when operating and in the standby mode.

Very loud operation of the power transformer may be caused by low quality of power supply (voltage surges etc.).

In such a case, we suggest using a power filter or conditioner - you can also try to power this product from a different power line than other devices (e.g. from a power outlet in another room).

We strongly advise to contact a professional installer or dealer in order to install TAGA Harmony products.

We recommend using high quality TAGA Harmony cables and other installation accessories.



Kit Content

Subwoofer	1EA
Single RCA-RCA subwoofer cable	1EA
Power Cable	1EA
Instruction Manual	1EA

EU declaration of conformity

	<p>Your product is marked with the symbol shown on the left. As its manufacturer, hereby we declare that the product is in compliance with the following EU directives and regulations: UE: 2014/35/EU (LVD) & 2014/53/EU & 2011/65/EU (RoHS)</p> <p>The full text of the EU declaration of conformity is available from the manufacturer.</p>
---	--

Disposal of the product

 	<p>Disposal of old electrical & electronic equipment (applicable in the European Union and other countries with separate collection systems)</p> <p>This symbol on the product or on its literature and packaging indicates that this product shall not be treated as household waste. Instead it shall be handed over to the appropriate collection point for the recycling of electrical and electronic equipment. By ensuring that this product is disposed of correctly, you will help to prevent potential negative consequences for the environment and human health, which could be caused by inappropriate waste handling of this product. The recycling of materials will help to conserve natural resources. For more detailed information about recycling of this product, please contact your local government office, your household waste disposal service or the shop where you purchased the product.</p>
---	--

TAGA EUROPE
POLPAK POLAND Sp. z o.o.
AL.JEROZOLIMSKIE 331A
05-816 REGULY k/WARSZAWY, POLAND
Email: Sales@TagaHarmony.com

www.TagaHarmony.com

Notes

Notes
