



- de Wichtige Information zur Bedienungsanleitung Ihres neuen Kaffeespezialitäten-Vollautomaten:** Die beiliegende Bedienungsanleitung für die IMPRESSA J9.3 gilt auch für Ihre IMPRESSA J85.
- Geänderter Lieferumfang:** Die separate Heißwasserdüse ist nicht im Lieferumfang enthalten. Kapitel »Heißwasser«: Sie können Heißwasser problemlos mit der Cappuccino-Düse zubereiten. Die Zubereitung von Heißwasser funktioniert unabhängig von der verwendeten Düse.
- en Important information about the instructions for use for your new automatic speciality coffee machine:** The enclosed instructions for use for the IMPRESSA J9.3 also apply to the IMPRESSA J85.
- Change to equipment supplied as standard:** The separate hot water nozzle is not supplied as standard. 'Hot water' chapter: You can easily prepare hot water with the cappuccino frother. Hot water is prepared in the same way no matter whether you use the nozzle or the frother.
- fr Information importante concernant le mode d'emploi de votre nouvelle machine automatique à spécialités de café:** Le mode d'emploi ci-joint pour l'IMPRESSA J9.3 est également valable pour votre IMPRESSA J85.
- Modification du matériel fourni:** La buse à eau chaude séparée n'est pas fournie avec la machine. Chapitre « Eau chaude » : vous pouvez sans problème préparer de l'eau chaude avec la buse Cappuccino. La préparation d'eau chaude fonctionne indépendamment de la buse utilisée.
- it Informazioni importanti relative alle istruzioni per l'uso della Sua nuova macchina automatica per specialità di caffè:** Le allegate istruzioni per l'uso per l'IMPRESSA J9.3 sono valide anche per la Sua IMPRESSA J85.
- Dotazione modificata:** L'ugello acqua calda separato non è in dotazione. Capitolo «Acqua calda»: l'acqua calda può essere preparata senza problemi con l'ugello per cappuccino. La preparazione dell'acqua calda funziona indipendentemente dall'ugello utilizzato.
- nl Belangrijke informatie over de gebruiksaanwijzing van uw nieuwe volautomaat voor koffiespecialiteiten:** De meegeleverde gebruiksaanwijzing voor de IMPRESSA J9.3 geldt ook voor uw IMPRESSA J85.
- Gewijzigde leveringsomvang:** Het afzonderlijke heetwaterpijpe behoort niet tot de leveringsomvang. Hoofdstuk „Heet water“: u kunt met de cappuccinator probleemloos heet water bereiden. De bereiding van heet water werkt onafhankelijk van het gebruikte pijpje.

es Información importante para el modo de empleo de su nueva máquina automática para especialidades de café: Las instrucciones de servicio adjuntas para la IMPRESSA J9.3 también son válidas para la IMPRESSA J85.

Volumen de suministro modificado: El vaporizador de agua caliente separado no va incluido en el volumen de suministro. Capítulo «Agua caliente»: usted podrá preparar fácilmente agua caliente mediante el vaporizador Cappuccino. La preparación de agua caliente funciona de forma independiente del vaporizador utilizado.

pt Informações importantes sobre o manual de instruções da sua nova máquina de café: O manual de instruções fornecido para a IMPRESSA J9.3 é válido também para a sua IMPRESSA J85.

Alteração do material fornecido: O bocal da água quente separado não faz parte do material fornecido. Capítulo “Água quente”: com o bocal para cappuccino pode-se preparar água quente sem problemas. A preparação de água quente funciona independentemente do bocal utilizado.

sv Viktig information om bruksanvisningen till din nya helautomatiska kaffespecialitetsmaskin: Den medföljande bruksanvisningen för IMPRESSA J9.3 gäller även för din IMPRESSA J85.

Ändrad leverans: Det separata varmvattenmunstycket ingår inte i leveransen. Kapitlet ”Varmvatten”: Varmvatten kan enkelt göras i ordning med cappuccino-skummare. Varmvatten kan göras i ordning oberoende av vilket munstycke som används.

ru Важная информация о руководстве по эксплуатации Вашей новой автоматической кофе-машины: Приложенное руководство по эксплуатации для IMPRESSA J9.3 действительно также для Вашей IMPRESSA J85.

Измененный комплект поставки: Отдельная насадка для подачи горячей воды не входит в комплект поставки. Глава «Горячая вода»: Горячую воду можно легко приготовить при помощи насадки для приготовления капучино. Приготовление горячей воды осуществляется независимо от используемой насадки.

pl Ważna informacja dotycząca instrukcji obsługi nowego automatycznego ekspresu do specjalów kawowych: Załączona instrukcja obsługi ekspresu IMPRESSA J9.3 odnosi się także do ekspresu IMPRESSA J85.

Zmieniony zakres dostawy: Oddzielna dysza wrzątku nie jest objęta zakresem dostawy. Rozdział »Wrzątek«: Wrzątek można bez problemu przygotować przy użyciu dyszy cappuccino. Przygotowanie wrzątku jest możliwe niezależnie od stosowanej dyszy.



IMPRESSA J9.3 One Touch TFT Instructions for Use

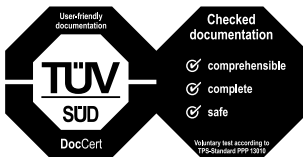

The Instructions for Use has been awarded the seal of approval by the independent German Technical Inspection Agency, TÜV SÜD, due to its easy-to-understand style, its thoroughness and coverage of safety aspects.



Your IMPRESSA J9.3 One Touch TFT

Control elements	4
Important information	6
Proper use	6
For your safety	6
1 Preparing and using for the first time	10
JURA on the Internet.....	10
Setting up the machine	10
Filling the water tank.....	10
Filling the bean container.....	10
First-time use	11
Inserting and activating the filter.....	12
Determining and adjusting the water hardness.....	13
Adjusting the grinder	15
2 Preparation	16
Ways of preparing a beverage	16
Espresso and coffee	17
Preparing two speciality coffees.....	17
Latte macchiato, cappuccino	18
Warm milk and milk foam.....	19
Ground coffee.....	19
Permanently setting the amount of water for the cup size	20
Hot water	21
3 Daily operation	22
Switching on	22
Daily maintenance	22
Switching off	23
4 Permanent settings in programming mode	24
Product settings	25
Maintenance settings	26
Energy-saving mode	27
Automatic switch-off.....	28
Unit for amount of water.....	29
Restore factory settings	29
Language	30
Colour scheme.....	31
Viewing information	31

5	Maintenance	32
	Rinsing the machine	32
	Rinsing the cappuccino frother	33
	Cleaning the cappuccino frother	33
	Dismantling and rinsing the cappuccino frother	34
	Changing the filter	34
	Cleaning the machine	36
	Descaling the machine	37
	Cleaning the bean container.....	39
	Descaling the water tank.....	39
6	Display messages	40
7	Troubleshooting	41
8	Transport and environmentally friendly disposal	43
	Transport / Emptying the system.....	43
	Disposal.....	43
9	Technical data	44
10	Index	45
11	JURA contact details / Legal information	48

Symbol description

Warnings

	CAUTION	Always take note of any information marked with the words CAUTION or
	WARNING	WARNING and a warning sign. The signal word WARNING draws your attention to potential serious injury, and the signal word CAUTION to potential minor injury.
CAUTION	CAUTION	CAUTION draws your attention to potential damage to the machine.

Symbols used

- ▶ **Prompt to take action.** This symbol means that you are being prompted to perform some action.

i **Information** and tips to make it even easier to use your IMPRESSA.

'Espresso' **Display**

Control elements

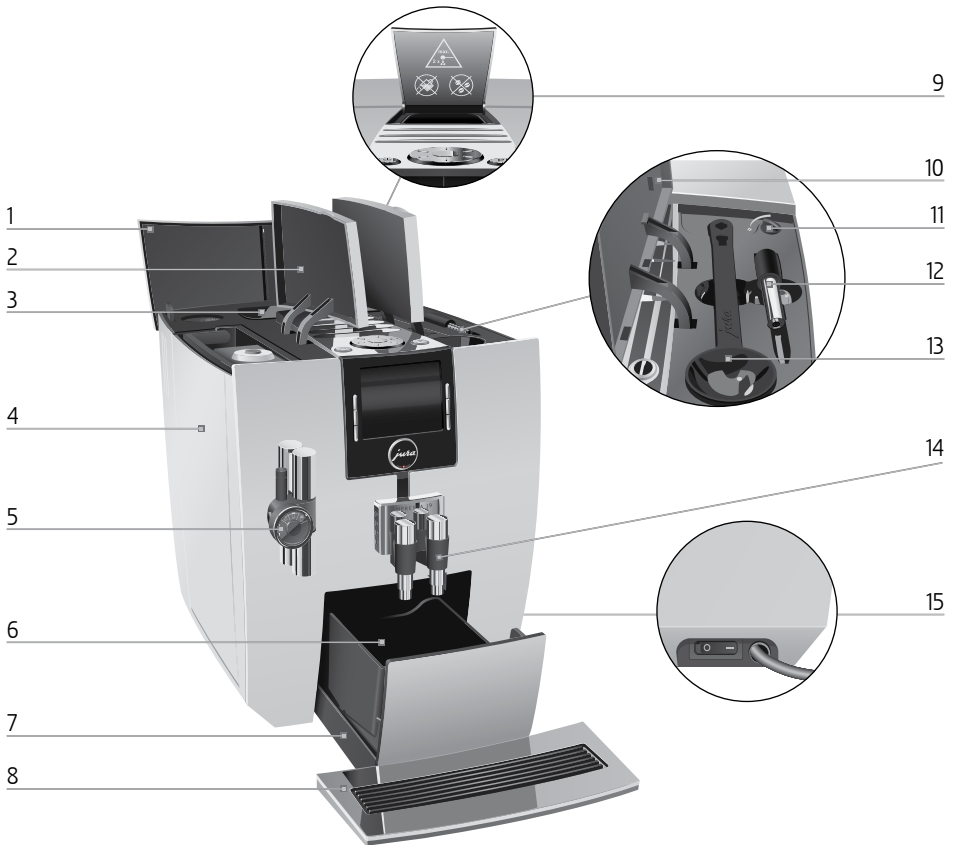



- 1 Bean container cover
- 2 Water tank cover
- 3 Bean container with aroma preservation cover
- 4 Water tank
- 5 Height-adjustable cappuccino frother
- 6 Coffee grounds container
- 7 Drip tray
- 8 Cup platform

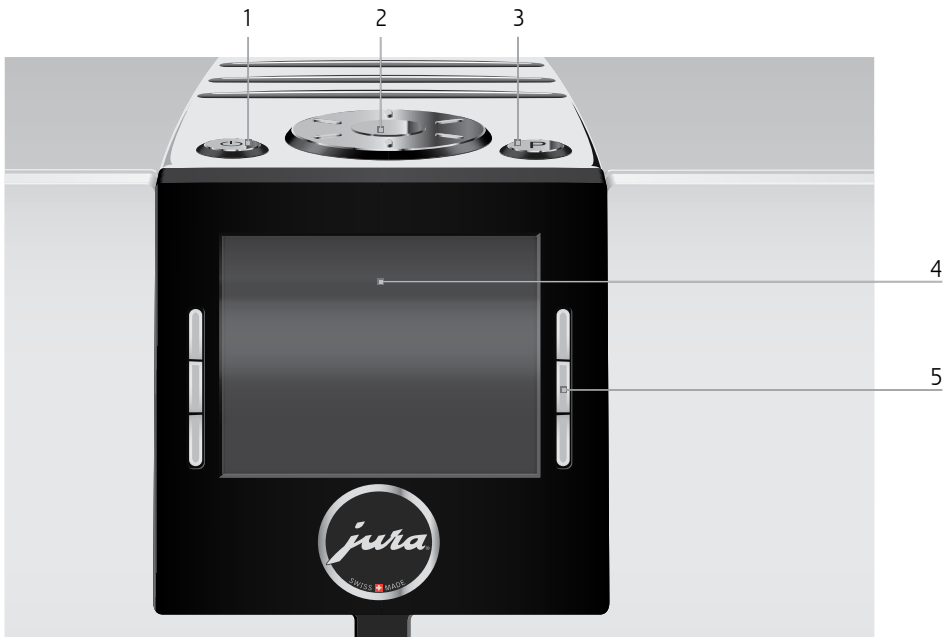

- 9 Filler funnel for ground coffee
- 10 Storage compartment cover
- 11 Grinder adjustment switch
- 12 Hot-water nozzle
- 13 Measuring spoon for ground coffee
- 14 Height- and width-adjustable coffee spout
- 15 Power switch and mains cable (side of machine)



Top of the machine

- 1  On/Off button
- 2  Rotary Switch
- 3  P button (programming)

Front

- 4  Display
- 5  Buttons (button function depends on what is shown in the display)

Important information

Proper use

The machine is designed and intended for private domestic use. It should only be used for coffee preparation and to heat milk and water. Use for any other purpose will be deemed improper. JURA Elektroapparate AG cannot accept any responsibility for the consequences of improper use.

Before using the machine read these instructions for use thoroughly and completely and comply with the instructions they contain. A warranty service is not applicable for damage or defects caused by non-compliance with the instructions for use. Keep these instructions for use close to the machine and pass them on to the next user.

For your safety

Please carefully read and observe the important safety information set out below.



To avoid danger of potentially fatal electric shock:

- Never use a machine which is damaged or has a defective mains cable.
- In the event of signs of damage, for example if there is a smell of burning, unplug the machine immediately from the mains supply and contact JURA service.
- If the mains cable of this machine is damaged, it must be repaired either directly by JURA or by an authorised JURA service centre.
- Make sure that the IMPRESSA and the mains cable are not located close to hot surfaces.
- Be careful to ensure that the mains cable is not trapped and does not rub against sharp edges.

- Never open and repair the machine yourself. Do not modify the machine in any way that is not described in these instructions for use. The machine contains live parts. If opened, there is a danger of potentially fatal injury. Repairs may only be carried out by authorised JURA service centres, using original spare parts and accessories.
- To completely and safely disconnect the machine from the power supply, first switch off the IMPRESSA using the On/Off button and then at the power switch. Only then should you remove the mains plug from the power socket.

There is a risk of scalds or burns on the spouts and the cappuccino frother.

- Place the machine out of the reach of children.
- Do not touch any hot parts. Use the handles provided.
- Ensure that the cappuccino frother is correctly fitted and clean. If incorrectly fitted or if they become blocked, the cappuccino frother or its parts might come off.

A defective machine is not safe and could cause injury or fire. To avoid damage and any associated risk of injury or fire:

- Never allow the mains cable to loosely hang down. The mains cable could pose a tripping hazard or become damaged.
- Protect the IMPRESSA from environmental influences such as rain, frost and direct sunlight.

Important information

- Do not immerse the IMPRESSA, mains cable or connections in water.
- Do not put the IMPRESSA or any individual parts in the dishwasher.
- Switch your IMPRESSA off at the power switch before any cleaning operation. Always wipe the IMPRESSA with a damp cloth rather than a wet one, and protect it from prolonged exposure to water splash.
- Only connect the machine to the mains voltage in accordance with the information on the rating plate. The rating plate is located on the underside of your IMPRESSA. Further technical data is provided in these instructions for use (see Chapter 9 'Technical data').
- Please only use original JURA maintenance products. Use of products that are not explicitly recommended by JURA could damage the IMPRESSA.
- Do not use any coffee beans treated with additives or caramelised coffee beans.
- Only fill the water tank with fresh, cold water.
- Switch the machine off at the power switch if you are going to be absent for a longer period of time.
- Children may not clean or service the machine unless supervised by a responsible person.
- Do not allow children to play with the machine.

- Keep children under the age of 8 away from the machine, or supervise them constantly.
- Children aged 8 and over may only operate the machine without supervision if they have been instructed in how to use it safely. Children must be able to recognise and understand the potential dangers arising from incorrect use.

People, including children, who

- do not have the physical, sensory or mental capabilities to use the machine safely or
- are inexperienced or lack knowledge in how to use the machine safely

must be supervised by a responsible person when using it, or must be instructed in how to use it correctly.

Safety when handling the CLARIS Blue filter cartridge:

- Filter cartridges should be kept out of the reach of children.
- Store filter cartridges in a dry place in the sealed packaging.
- Protect cartridges from heat and direct sunlight.
- Do not use damaged filter cartridges.
- Do not open filter cartridges.

1 Preparing and using for the first time

JURA on the Internet

Visit us on the Internet. You can download **short operating instructions** for your machine from the JURA website (www.jura.com). You will also find interesting and up-to-date information on your IMPRESSA and on every aspect of coffee.

Setting up the machine

When setting up your IMPRESSA, please note the following:

- Place the IMPRESSA on a horizontal surface that is not sensitive to water.
- Choose a spot for your IMPRESSA which protects the machine against overheating. Ensure that the ventilation slots are not covered.

Filling the water tank

To enjoy the perfect cup of coffee we recommend changing the water every day.

CAUTION

Milk, sparkling mineral water or other liquids can damage the water tank or the machine.

- ▶ Only fill the water tank with fresh, cold water.
-
- ▶ Open the water tank cover.
 - ▶ Remove the water tank and rinse it with cold water.
 - ▶ Fill the water tank with fresh, cold water and reinsert the tank.
 - ▶ Close the water tank cover.

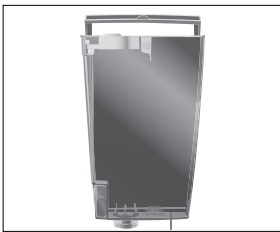

Filling the bean container

The bean container has an aroma preservation cover. This will ensure that your coffee beans retain their aroma for longer.

CAUTION

Coffee beans which have been treated with additives (e.g. sugar), ground coffee or freeze-dried coffee will damage the grinder.

- ▶ Only use untreated coffee beans to fill the bean container.
-
- ▶ Open the bean container cover and remove the aroma preservation cover.

- ▶ Remove any dirt or foreign objects from inside the bean container.
- ▶ Fill the bean container with coffee beans, then close the aroma preservation cover and the bean container cover.

First-time use

⚠ WARNING

If the machine is operated with a defective mains cable, there is a danger of potentially fatal electric shock.

- ▶ Never use a machine which is damaged or has a defective mains cable.

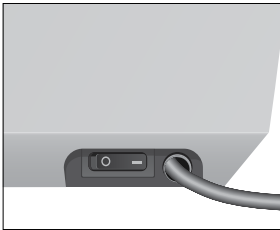



Precondition: The water tank and bean container have been filled.

- ▶ Insert the mains plug into a power socket.
- ▶ Switch on the IMPRESSA using the power switch on the right-hand side of the machine.
- ▶ Press the On/Off button to switch the IMPRESSA on. The JURA logo appears. The display then shows the languages you can choose from.
- i** To display more languages, press the **'Next'** button (bottom right).
- ▶ Press the button that corresponds to the language you want, e.g. **'English'**. **'Saved'** appears briefly on the display to confirm the setting. **'Please press the Rotary Switch.'**, the Rotary Switch lights up.
- ▶ Place a receptacle under the cappuccino frother.
- ▶ Press the Rotary Switch. **'System is filling.'**, the system fills up with water. The operation stops automatically. **'Please press the Rotary Switch.'**





1 Preparing and using for the first time



- ▶ Place a receptacle under the coffee spout.
-  ▶ Press the Rotary Switch.
'Machine is rinsing.', the machine rinses. The operation stops automatically. **'Please select product:'** appears on the display. The IMPRESSA is now ready for use.
-  The display shows the products you can prepare.

Inserting and activating the filter

Your IMPRESSA no longer has to be descaled if you are using the CLARIS Blue filter cartridge. If the water hardness is 10 °dH or more, we recommend using the filter cartridge.

-  If you do not know the hardness of your water, you must find this out first (see Chapter 1 'Preparing and using for the first time – Determining the water hardness').
-  Perform the 'inserting the filter' operation without any interruptions. This will ensure that your IMPRESSA always produces its best.

Precondition: **'Please select product:'** is displayed.

- P** ▶ Press the P button.
'Maintenance status (1/6)'
-  ▶ Turn the Rotary Switch until the programme item **'Maintenance settings (3/6)'** is displayed.
 - ▶ Press the **'Filter'** button.
'Filter'
 - ▶ Press the **'Active'** button.
 - ▶ Press the **'Save'** button.
'Saved' appears briefly on the display.
'Insert filter'
 - ▶ Remove the filter cartridge extension from the Welcome Pack.
 - ▶ Fit the filter extension on top of a CLARIS Blue filter cartridge.
 - ▶ Remove and empty the water tank.



- ▶ Open the filter holder and insert the filter cartridge into the water tank, exerting slight pressure.
- ▶ Close the filter holder. It will click into place audibly.

i After two months, the filter will cease to work. You can check the elapsed time by referring to the date plate on the filter holder in the water tank.

- ▶ Fill the water tank with fresh, cold water and reinsert the tank.
- ▶ Place a receptacle (at least 500 ml) under the cappuccino frother.
- ▶ Press the 'Next' button.
'Filter is being rinsed.', water flows out of the cappuccino frother.



i You can interrupt rinsing of the filter at any time by pressing any button. Press the Rotary Switch  to continue rinsing of the filter.

i The water may be slightly discoloured. This is not harmful to health and does not affect the taste.

Rinsing of the filter stops automatically after approximately 500 ml. The machine heats up. 'Please select product:' appears on the display. The filter is now activated.

Determining and adjusting the water hardness

i If you are using the CLARIS Blue filter cartridge and have activated it in programming mode, you will not be able to adjust the water hardness.

The harder the water is, the more frequently the IMPRESSA needs to be descaled. It is therefore important to adjust the water hardness.

The water hardness can be adjusted on a continuous scale between 1 °dH and 30 °dH.

1 Preparing and using for the first time

Determining the water hardness

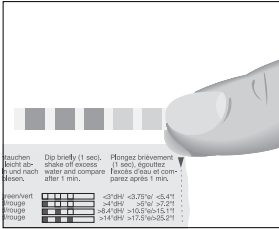

You can find out what the water hardness is by using the Aquadur® test strip supplied as standard.

- ▶ Hold the test strip briefly (for 1 second) under flowing water. Shake off the water.
 - ▶ Wait for about one minute.
 - ▶ You will then be able to read the degree of water hardness from the discolouration of the Aquadur® test strip and the description on the packaging.
- You can now adjust the water hardness.

Adjusting the water hardness

Precondition: 'Please select product:' is displayed.

- P** ▶ Press the P button.
'Maintenance status (1/6)'
-  ▶ Turn the Rotary Switch until the programme item 'Maintenance settings (3/6)' is displayed.
- ▶ Press the 'Water hardness' button.
'Water hardness'
- ▶ Press the '<' or '>' button to set the water hardness.
- ▶ Press the 'Save' button.
'Saved' appears briefly on the display to confirm the setting.
'Maintenance settings (3/6)'
- P** ▶ Press the P button to exit programming mode.
'Please select product:'

Adjusting the grinder

You can adjust the grinder on a continuous scale to suit the degree of roast of your coffee.

CAUTION

If you adjust the consistency of grind when the grinder is not operating, the grinder adjustment switch could be damaged.

- ▶ Only adjust the consistency of grind when the grinder is running.





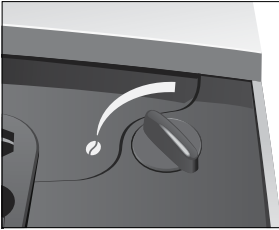

The consistency of grind setting is correct if the coffee flows regularly from the coffee spout. In addition a fine, thick crema forms.

Example: Proceed as follows to change the consistency of grind **during** the preparation of an espresso.

- ▶ Open the storage compartment cover.
- ▶ Place a cup under the coffee spout.
- ▶ Press the 'Espresso' button.
The grinder starts up. 'Espresso' is displayed.
- ▶ Turn the grinder adjustment switch to the desired position **while** the grinder is running.
The espresso is prepared and the consistency of grind is adjusted.
- ▶ Close the storage compartment cover.



2 Preparation

- i** You can stop preparation of a speciality coffee, speciality coffee with milk or hot water at any time. Just press any button.
- i** During the grinding operation you can select the **coffee strength** of individual products by turning the Rotary Switch :  (extra-mild),  (mild),  (normal),  (strong) or  (extra-strong).
- i** During preparation, you can change the preset **amount of water** by turning the Rotary Switch  or pressing the '**<**' and '**>**' buttons.
- i** You can follow the current status of preparation on the display.

You can make permanent settings for all products in programming mode (see Chapter 4 'Permanent settings in programming mode – Product settings').

Ways of preparing a beverage

Only some of the speciality coffees you can prepare are shown on the display at any one time. As soon as you turn the Rotary Switch, more speciality coffees are displayed in the product selector. The product selector disappears automatically after 5 seconds if no preparation is started.

The following speciality coffees are displayed as standard:

- 'Espresso'
- 'Coffee'
- 'Cappuccino'
- 'Latte macchiato'
- 'Hot water'
- '1 portion milk'

Additional speciality coffees in the product selector:

- 'Ristretto'
- '2 espressi'
- '2 coffees'
- '2 ristretti'

Espresso and coffee

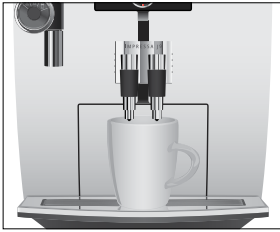

'Espresso' and 'Coffee' are prepared following this model.

Example: Proceed as follows to prepare one coffee.

- ▶ Place a cup under the coffee spout.
- ▶ Press the 'Coffee' button.
Preparation will now begin. The preset amount of water for coffee flows into the cup.
Preparation stops automatically and 'Please select product:' appears on the display.

Preparing two speciality coffees



To prepare **two** speciality coffees, either use the product selector or press the appropriate preparation button twice.

Example: Proceed as follows to prepare **two coffees** (using product selector).

- ▶ Place two cups under the coffee spout.
- ⦿ ▶ Turn the Rotary Switch to view the product selector.
- ⦿ ▶ Turn the Rotary Switch until '2 coffees' is displayed.
- ⦿ ▶ Press the Rotary Switch.
Preparation starts and the preset amount of water for coffee flows into the cups.
Preparation stops automatically and 'Please select product:' appears on the display.

i Proceed as follows to prepare two cups of coffee at the touch of a button: Place two cups under the coffee spout. Press the 'Coffee' button twice (**within two seconds**) to start coffee preparation.

Latte macchiato, cappuccino

Your IMPRESSA can prepare a latte macchiato or cappuccino at the touch of a button. There is no need to move the glass or cup.

Example: Proceed as follows to prepare one latte macchiato.

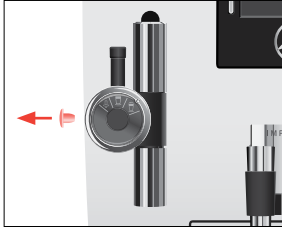

- ▶ Remove the protective cover from the cappuccino frother.
- ▶ Attach the milk pipe to the cappuccino frother. Use the long pipe for a milk carton and the short pipe for a milk container.
- ▶ Insert the other end of the milk pipe into a milk carton or connect it to a milk container.

- ▶ Place a glass under the cappuccino frother.
 - ▶ Turn the setting wheel of the cappuccino frother to the Milk Foam position .
 - ▶ Press the 'Latte macchiato' button.
- 'Latte macchiato', the milk foam is prepared.
- Preparation stops automatically when the preset amount of milk is reached.

i There is a short interval while the hot milk separates from the milk foam. This allows the typical layers of a latte macchiato to form. You can choose the length of this interval in programming mode (see Chapter 4 'Permanent settings in programming mode – Product settings').

Coffee preparation starts. The preset amount of water flows into the glass. Preparation stops automatically and 'Please select product:' appears on the display.

To make sure the cappuccino frother always works properly, rinse and clean it regularly (see Chapter 5 'Maintenance – Rinsing the cappuccino frother').

Warm milk and milk foam

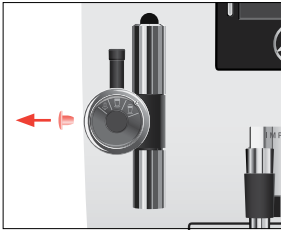

Example: Proceed as follows to prepare milk foam.

- ▶ Remove the protective cover from the cappuccino frother.
- ▶ Attach the milk pipe to the cappuccino frother. Use the long pipe for a milk carton and the short pipe for a milk container.
- ▶ Insert the other end of the milk pipe into a milk carton or connect it to a milk container.

- ▶ Place a cup under the cappuccino frother.
- ▶ Turn the setting wheel of the cappuccino frother to the Milk Foam position .

i If you want to **heat the milk** turn the setting wheel of the cappuccino frother to the Milk position .

- ▶ Press the '1 portion milk' button.

'1 portion milk'

As soon as the machine has heated up, 'Please select product:' appears.

- ▶ Press the '1 portion milk' button again.

'1 portion milk',

the milk foam is prepared. Preparation stops automatically when the preset amount of milk is reached.

'Please select product:' appears on the display.

To make sure the cappuccino frother always works properly, rinse and clean it regularly (see Chapter 5 'Maintenance – Rinsing the cappuccino frother').

Ground coffee

You can choose to use a second coffee variety, for example decaffeinated coffee, with the filler funnel for ground coffee.

- i** Never add more than two level measuring spoons of ground coffee.
- i** Use ground coffee which is not ground too finely. Very fine coffee can block up the system so that the coffee only comes out in drips.
- i** If you did not fill the machine with a sufficient amount of ground coffee, 'Not enough ground coffee' is displayed and the IMPRESSA stops the operation.

2 Preparation

- i** The desired speciality coffee must be prepared within approximately one minute after filling with the ground coffee. Otherwise the IMPRESSA stops the operation and is once more ready for use.

All speciality coffees with ground coffee are prepared following this model.

Example: Proceed as follows to prepare one espresso using ground coffee.



- ▶ Place an espresso cup under the coffee spout.
- ▶ Open the cover of the filler funnel for ground coffee.
'Please add ground coffee.'
- ▶ Place one level measuring spoon of ground coffee into the filler funnel.
- ▶ Close the cover of the filler funnel.
'Please select product.'
- ▶ Press the **'Espresso'** button.
Preparation will now begin. The preset amount of water for espresso flows into the cup. Preparation stops automatically and **'Please select product.'** appears on the display.

Permanently setting the amount of water for the cup size

It is easy to make permanent settings for the amount of water for all speciality coffees and hot water according to the cup size. Adjust the amount once as shown in the following example. Every time you prepare a drink in the future, this amount of water will be dispensed.

The permanent settings for adapting the amount of water to the cup size for all speciality coffees and hot water follow this model.

Example: Proceed as follows to **permanently** set the amount of water for one coffee.

Precondition: **'Please select product.'** is displayed.

- ▶ Place a cup under the coffee spout.
- ▶ Press and **hold** the **'Coffee'** button.
'Coffee' and the fill volume are displayed.
- ▶ **Hold** the **'Coffee'** button down until **'Enough water? Press button'** appears.
- ▶ Release the **'Coffee'** button.
Preparation starts and the coffee flows into the cup.

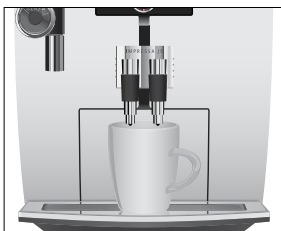

- ▶ Press any button as soon as there is sufficient coffee in the cup.

Preparation stops. 'Saved' appears briefly on the display. The set amount of water for one coffee is permanently stored. 'Please select product:' appears on the display.

- i** You can alter this setting at any time by repeating the above procedure.
- i** You can also permanently set the amount for all speciality coffees and hot water in programming mode (see Chapter 4 'Permanent settings in programming mode – Product settings').

Hot water

To obtain a perfect water flow, use the hot-water nozzle. You can find the hot-water nozzle under the cover of the storage compartment.

The following temperatures can be selected for preparing hot water: 'Low', 'Normal', 'X high'.

⚠ CAUTION

There is a danger of scalding from hot water splashes.

- ▶ Avoid direct contact with the skin.



- ▶ Carefully pull the cappuccino frother down and off.
 - ▶ Open the storage compartment cover, take out the hot-water nozzle and close the cover again.
 - ▶ Attach the hot-water nozzle to the connector.
 - ▶ Place a cup under the hot-water nozzle.
 - ▶ Press the 'Hot water' button.
- 'Hot water' and the temperature are displayed.

- i** By pressing the '<' or '>' button several times (**within approximately 2 seconds**) you can set the temperature to your individual preference. This setting is not saved.

'Hot water', hot water flows into the cup. Preparation stops automatically and 'Please select product:' appears on the display.



3 Daily operation

Switching on

When the IMPRESSA is switched on, it automatically prompts you to perform the rinse operation. Start the rinse operation by pressing the Rotary Switch . In programming mode you can change this setting so that the machine starts the switch-on rinse automatically.



Precondition: Your IMPRESSA is switched on at the power switch.

- ▶ Place a receptacle under the coffee spout.
-  ▶ Press the On/Off button to switch the IMPRESSA on.
‘Welcome to JURA’ appears on the display. The machine heats up.
‘Please press the Rotary Switch.’
-  ▶ Press the Rotary Switch.
The machine rinses. The operation stops automatically and
‘Please select product:’ appears on the display.

Daily maintenance

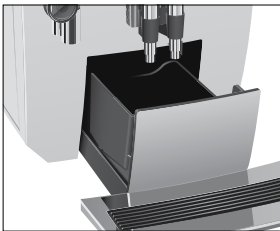

To ensure that you get many years of reliable service out of your IMPRESSA and to guarantee the optimum coffee quality, the machine requires daily maintenance.

- ▶ Pull out the drip tray.
- ▶ Empty the coffee grounds container and the drip tray. Rinse them both with warm water.
- ▶ Dry the metal contacts on the back of the drip tray.
- ▶ Refit the coffee grounds container and the drip tray.
- ▶ Rinse the water tank with clean water.
- ▶ Dismantle and rinse the cappuccino frother (see Chapter 5 ‘Maintenance – Rinsing the cappuccino frother’).
- ▶ Wipe the surface of the machine with a clean, soft, damp cloth (e.g. microfibre cloth).

Switching off



When you switch your IMPRESSA off, the spouts used to prepare a speciality coffee or milk are rinsed.

- ▶ Place one receptacle under the coffee spout and another under the cappuccino frother.
- ▶ Press the On/Off button.

‘Machine is rinsing.’, ‘Milk system is being rinsed.’. The spouts used to prepare a speciality coffee or milk are rinsed. The operation stops automatically and your IMPRESSA is switched off.

- i** When the IMPRESSA is switched off with the On/Off button, the machine consumes less than 0.1 W of standby energy. The machine can be completely disconnected from the power supply using the power switch.

4 Permanent settings in programming mode

Press the P button to enter programming mode. You can navigate through the programme items and permanently save the required settings simply by turning the Rotary Switch and using the variable buttons. The following settings can be made:

Programme item	Sub-item	Explanation
'Maintenance status (1/6)'	'Clean', 'Descale' (only if filter is not activated), 'Change the filter' (only if filter is activated), 'Rinse the coffee system', 'Clean the milk system'	▶ Start the required maintenance programme here.
'Product settings (2/6)'	'Expert mode'	▶ Select your settings for speciality coffees and hot water.
'Maintenance settings (3/6)'	'Filter', 'Water hardness' (only if filter is not activated), 'Rinse the coffee system', 'Rinse the milk system'	▶ Indicate whether you are operating your IMPRESSA with or without a CLARIS Blue filter cartridge. ▶ Adjust the water hardness. ▶ Change the settings for the switch-on rinse and milk system rinse.
'Machine settings 1 (4/6)'	'Save energy', 'Switch off after', 'Units', 'Factory setting'	▶ Select an energy-saving mode. ▶ Set the time after which the IMPRESSA should switch off automatically. ▶ Select the unit for the amount of water. ▶ Reset the permanently set values of all products to the factory settings.
'Machine settings 2 (5/6)'	'Choose language', 'Display', 'Colour scheme'	▶ Select your language and the background colour for the display.
'Information (6/6)'	'Product counter', 'Maintenance counter', 'Version'	▶ Keep track of all speciality coffees prepared and view the number of maintenance programmes performed.

Product settings

In the programme item 'Product settings (2/6)' you can make individual settings for all speciality coffees and hot water. The following settings can be made:

Product	Temperature	Coffee strength	Amount
Ristretto, espresso, coffee	'Normal', 'High'	'extra-mild ☉', 'mild ☉☉', 'normal ☉☉☉', 'strong ☉☉☉☉', 'extra-strong ☉☉☉☉☉'	Volume: '25 ml' – '240 ml'
Two ristretti, two espressi, two coffees	'Normal', 'High'	–	Volume: '25 ml' – '240 ml' (per cup)
Latte macchiato, cappuccino	'Normal', 'High'	'extra-mild ☉', 'mild ☉☉', 'normal ☉☉☉', 'strong ☉☉☉☉', 'extra-strong ☉☉☉☉☉'	Amount of milk: '3 sec.' – '120 sec.' Interval: '0 sec.' – '60 sec.' Volume: '25 ml' – '240 ml'
Milk portion	–	–	'3 sec.' – '120 sec.'
Hot water	'Low', 'Normal', 'X high'	–	'25 ml' – '450 ml'

Example: Proceed as follows to change the amount of milk for a latte macchiato from '16 sec.' to '20 sec.', the interval from '30 sec.' to '40 sec.' and the amount of water from '45 ml' to '40 ml'.

Precondition: 'Please select product:' is displayed.

P ▶ Press the P button.

'Maintenance status (1/6)'

 ▶ Turn the Rotary Switch until the programme item 'Product settings (2/6)' is displayed.

▶ Press the 'Expert mode' button.
'Expert mode'

i Next select the button of the product for which you would like to make settings. No product is prepared at this point.

▶ Press the 'Latte macchiato' button.
'Latte macchiato'

▶ Press the 'Amount of milk' button.

▶ Press the '<' or '>' button to change setting for the amount of milk to '20 sec.'.

4 Permanent settings in programming mode

- ▶ Press the 'Save' button.
'Saved' appears briefly on the display.
- ▶ Press the 'Volume' button.
- ▶ Press the '<' or '>' button to change setting for the fill volume to '40 ml'.
- ▶ Press the 'Save' button.
'Saved' appears briefly on the display.
- ▶ Press the 'Next' button.
- ▶ Press the 'Interval' button.
- ▶ Press the '<' or '>' button to change setting for the interval to '40 sec.'.
- ▶ Press the 'Save' button.
'Saved' appears briefly on the display.
'Latte macchiato'
- P ▶ Press the P button to exit programming mode.
'Please select product:'

Maintenance settings

In the programme item 'Maintenance settings (3/6)' you can make the following settings:

- 'Filter'
 - Activate the CLARIS Blue filter cartridge (see Chapter 1 'Preparing and using for the first time – Inserting and activating the filter').
- 'Water hardness'
 - If you do not have a filter cartridge, you will need to set the water hardness (see Chapter 1 'Preparing and using for the first time – Adjusting the water hardness').
- 'Rinse the coffee system' / 'Manual'
 - The switch-on rinse must be started manually.
- 'Rinse the coffee system' / 'Automatic'
 - The switch-on rinse is started automatically.
- 'Rinse the milk system' / 'After 10 min.'
 - You are prompted to rinse the milk system 10 minutes after preparation of a speciality coffee with milk.
- 'Rinse the milk system' / 'Immediate'
 - You are prompted to rinse the milk system immediately after preparation of a speciality coffee with milk.

Example: Proceed as follows to make the machine prompt you to rinse the milk system **immediately** after preparing a speciality coffee with milk.

Precondition: 'Please select product:' is displayed.

- P ▶ Press the P button.
'Maintenance status (1/6)'
- ⊙ ▶ Turn the Rotary Switch until the programme item 'Maintenance settings (3/6)' is displayed.
 - ▶ Press the 'Rinse the milk system' button.
'Rinse the milk system'
 - ▶ Press the 'Immediate' button.
 - ▶ Press the 'Save' button.
'Saved' appears briefly on the display.
'Maintenance settings (3/6)'
- P ▶ Press the P button to exit programming mode.
'Please select product:'

Energy-saving mode

In the programme item 'Machine settings 1 (4/6)' / 'Save energy' you can permanently set an energy-saving mode (Energy Save Mode, E.S.M.®):

- 'Inactive'
 - All speciality coffees, speciality coffees with milk and hot water can be prepared without having to wait.
 - Before milk preparation, the machine heats up.
- 'Active' (Energy saving of up to 40%)
 - Soon after the last preparation, the IMPRESSA stops heating up. As soon as the energy-saving temperature is reached, this is indicated in the display by the message 'Save energy' – this may take several minutes.
 - The machine heats up before coffee, hot water or milk preparation.

Example: Proceed as follows to change the energy-saving mode from 'Inactive' to 'Active'.

Precondition: 'Please select product:' is displayed.

- P ▶ Press the P button.
'Maintenance status (1/6)'

4 Permanent settings in programming mode

- ▶ Turn the Rotary Switch until the programme item 'Machine settings 1 (4/6)' is displayed.
- ▶ Press the 'Save energy' button.
'Save energy'
- ▶ Press the 'Active' button.
- ▶ Press the 'Save' button.
'Saved' appears briefly on the display.
'Machine settings 1 (4/6)'
- P ▶ Press the P button to exit programming mode.
'Please select product:'

Automatic switch-off

By instructing your IMPRESSA to automatically switch itself off, you can cut down your energy consumption. If this function is activated, your IMPRESSA switches off automatically after the preset time following the last action on the machine.

You can set the automatic switch-off time to 15 minutes or 0.5 – 15 hours.

Precondition: 'Please select product:' is displayed.

- P ▶ Press the P button.
'Maintenance status (1/6)'
- ▶ Turn the Rotary Switch until the programme item 'Machine settings 1 (4/6)' is displayed.
- ▶ Press the 'Switch off after' button.
'Switch off after'
- ▶ Press the '<' or '>' button to change the setting.
- ▶ Press the 'Save' button.
'Saved' appears briefly on the display.
'Machine settings 1 (4/6)'
- P ▶ Press the P button to exit programming mode.
'Please select product:'

Unit for amount of water

You can change the unit for the amount of water from 'ml' to 'oz'.

Example: Proceed as follows to change the unit for the amount of water from 'ml' to 'oz'.

Precondition: 'Please select product:' is displayed.

- P ▶ Press the P button.
'Maintenance status (1/6)'
-  ▶ Turn the Rotary Switch until the programme item 'Machine settings 1 (4/6)' is displayed.
 - ▶ Press the 'Units' button.
'Units'
 - ▶ Press the 'oz' button.
 - ▶ Press the 'Save' button.
'Saved' appears briefly on the display.
'Machine settings 1 (4/6)'
- P ▶ Press the P button to exit programming mode.
'Please select product:'

Restore factory settings

In the programme item 'Machine settings 1 (4/6)' / 'Factory setting' you can reset various settings to their factory settings:

- 'Machine'
 - **All customer settings** (apart from the 'filter') are reset to factory settings. Your IMPRESSA then switches off.
- 'Products'
 - The settings (amount of water, aroma, temperature etc.) for any product can be reset **individually** to the factory settings. The corresponding double product is also reset to the factory settings at the same time.
- 'All products'
 - The settings (amount of water, aroma, temperature etc.) for **all products** are reset to the factory settings.
- 'Display'
 - All display settings are reset to the factory settings.

Example: Proceed as follows to reset the values for 'Espresso' to the factory settings.

Precondition: 'Please select product:' is displayed.

- P ▶ Press the P button.
'Maintenance status (1/6)'

4 Permanent settings in programming mode

- ⊙ ▶ Turn the Rotary Switch until the programme item 'Machine settings 1 (4/6)' is displayed.
- ▶ Press the 'Factory setting' button.
'Factory setting'
- ▶ Press the 'Products' button.
- ▶ Press the 'Espresso' button.
'Espresso' / 'Reset this product to the factory setting?'
- ▶ Press the 'Next' button.
'Saved' appears briefly on the display.
'Factory setting'
- P ▶ Press the P button to exit programming mode.
'Please select product:.'

Language

In this programme item you can set the language used by your IMPRESSA.

- i** If you choose the wrong language by mistake, you can easily reset the machine to 'English': Press the P button to enter programming mode. Use the Rotary Switch ⊙ to select programme item '5/6' and then press the top left-hand button.

Example: Proceed as follows to change the language from 'English' to 'Deutsch'.

Precondition: 'Please select product:.' is displayed.

- P ▶ Press the P button.
'Maintenance status (1/6)'
- ⊙ ▶ Turn the Rotary Switch until the programme item 'Machine settings 2 (5/6)' is displayed.
- ▶ Press the 'Choose language' button.
'Choose language'
- ▶ Press the 'Deutsch' button.
'Gespeichert' appears briefly on the display.
'Geräteeinstellungen 2 (5/6)'
- P ▶ Press the P button to exit programming mode.
'Bitte wählen Sie Ihr Produkt:.'

Colour scheme

In this programme item you can set the background colour for the display of your IMPRESSA.

Precondition: 'Please select product:' is displayed.

- P ▶ Press the P button.
'Maintenance status (1/6)'
-  ▶ Turn the Rotary Switch until the programme item 'Machine settings 2 (5/6)' is displayed.
 - ▶ Press the 'Colour scheme' button.
'Colour scheme'
 - ▶ Press the '<' or '>' button to change the setting.
 - ▶ Press the 'Save' button.
'Saved' appears briefly on the display.
'Machine settings 2 (5/6)'
- P ▶ Press the P button to exit programming mode.
'Please select product:'

i The selected background colour only applies on the selection page of the display showing the speciality coffees.

Viewing information

In the programme item 'Information (6/6)' you can view the following information:

- 'Product counter': Number of prepared speciality coffees, speciality coffees with milk and hot water
- 'Maintenance counter': Maintenance status and number of maintenance programmes performed (cleaning, descaling, changing the filter)
- 'Version': Software version

Precondition: 'Please select product:' is displayed.

- P ▶ Press the P button.
'Maintenance status (1/6)'
-  ▶ Turn the Rotary Switch until the programme item 'Information (6/6)' is displayed.
 - ▶ Press the 'Product counter' button.
The number of speciality coffees prepared is displayed.
 - ▶ Press the 'L' button.
'Information (6/6)'
- P ▶ Press the P button to exit programming mode.
'Please select product:'

5 Maintenance

Your IMPRESSA has the following integrated maintenance programmes:

- Rinsing the machine ('Rinse the coffee system')
- Rinsing the cappuccino frother ('Rinse the milk system')
- Cleaning the cappuccino frother ('Clean the milk system')
- Changing the filter ('Change the filter')
- Cleaning the machine ('Clean')
- Descaling the machine ('Descale')

- i** Clean or descale the machine, rinse the milk system or change the filter when you are prompted to do so.
- i** Press the P button to view a list of the maintenance programmes ('Maintenance status (1/6)'). By referring to the bar you can see how soon each maintenance programme is due. When the bar is completely filled with red, the IMPRESSA will prompt you to perform the maintenance programme.
- i** The IMPRESSA will not prompt you to clean the milk system. In the interests of hygiene, you should clean the milk system **daily** when you have been preparing milk.

Rinsing the machine



You can initiate the rinse operation manually at any time.

Precondition: 'Please select product:' is displayed.

- P** ▶ Place a receptacle under the coffee spout.
- ▶ Press the P button.
- 'Maintenance status (1/6)'
- ▶ Press the 'Rinse the coffee system' button.
- 'Machine is rinsing.', water flows out of the coffee spout.
- The rinse stops automatically and 'Please select product:' appears on the display.

Rinsing the cappuccino frother



After each milk preparation, the IMPRESSA prompts you to rinse the milk system.

Precondition: 'Rinse the milk system' is displayed.

- ▶ Place a receptacle under the cappuccino frother.
 - ▶ Press the Rotary Switch.
- 'Milk system is being rinsed.', water flows out of the cappuccino frother.
- The rinse stops automatically and 'Please select product:' appears on the display.

Cleaning the cappuccino frother

To ensure that the cappuccino frother always works properly, you should clean it **daily** when you have been preparing milk. Your IMPRESSA will **not** prompt you to clean the cappuccino frother.



CAUTION

If the wrong cleaning agent is used, the machine could be damaged and/or traces could be left behind in the water.

- ▶ Use only original JURA maintenance products.

i JURA Cappuccino Cleaner is available from stockists.

Precondition: 'Please select product:' is displayed.

- P** ▶ Press the P button.
- 'Maintenance status (1/6)'
- ▶ Press the 'Clean the milk system' button.
- 'Cleaning agent for milk system'
- ▶ Pour 250 ml of fresh water into a receptacle and add one capful (max. 15 ml) of Cappuccino Cleaner.
 - ▶ Immerse the milk pipe in the receptacle.
 - ▶ Turn the setting wheel of the cappuccino frother to the Milk Foam  or Milk  position.
 - ▶ Place another receptacle under the cappuccino frother.
 - ▶ Press the 'Next' button.
- 'Milk system is being cleaned.', water flows out of the cappuccino frother.
- 'Water for cleaning milk system'
- ▶ Rinse the receptacle thoroughly, fill it with 250 ml of fresh water and immerse the milk pipe in the water.





- ▶ Empty the other receptacle and place it under the cappuccino frother again.
- ▶ Press the 'Next' button.
'Milk system is being cleaned.', the cappuccino frother and the pipe are rinsed with fresh water.
'Please select product:' appears on the display.

Dismantling and rinsing the cappuccino frother

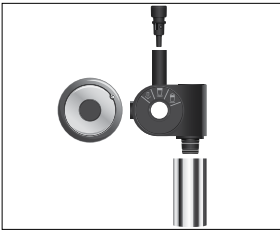

- ▶ Carefully pull the cappuccino frother down and off.
- ▶ Dismantle the cappuccino frother into its individual parts.
- ▶ Rinse all parts of the cappuccino frother thoroughly under running water.
- ▶ Reassemble the cappuccino frother.

- i** Ensure that all individual parts are correctly and firmly connected to ensure correct operation of the cappuccino frother.
- ▶ Firmly attach it to the connector.

Changing the filter

- i** After 50 litres of water have flowed through, the filter will cease to work. Your IMPRESSA will automatically prompt you to change the filter.
- i** After two months, the filter will cease to work. You can check the elapsed time by referring to the date plate on the filter holder in the water tank.
- i** If the CLARIS Blue filter cartridge is not activated in programming mode, you will not be prompted to change the filter.

Precondition: 'Change filter' is displayed.

- P** ▶ Press the P button.

'Maintenance status (1/6)'

- ▶ Press the 'Change the filter' button.
'Change the filter'

- i** If you do not want to start changing the filter just yet, press the 'L' button. The prompt 'Change filter' remains active.

- ▶ Press the 'Next' button.
'Change filter'
- ▶ Remove and empty the water tank.
- ▶ Open the filter holder and remove the old CLARIS Blue filter cartridge and filter extension.
- ▶ Fit the filter extension on top of a **new** filter cartridge.
- ▶ Insert the filter cartridge into the water tank, exerting slight pressure.
- ▶ Close the filter holder. It will click into place audibly.
- ▶ Fill the water tank with fresh, cold water and reinsert the tank.

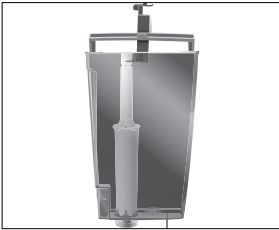

- ▶ Place a receptacle (at least 500 ml) under the cappuccino frother.
- ▶ Turn the setting wheel of the cappuccino frother to the Steam position ☒.
- ▶ Press the 'Next' button.
'Filter is being rinsed.', water flows out of the cappuccino frother.

- i** You can interrupt rinsing of the filter at any time by pressing any button. Press the Rotary Switch  to continue rinsing of the filter.
- i** The water may be slightly discoloured. This is not harmful to health and does not affect the taste.

Rinsing of the filter stops automatically after approximately 500 ml. The machine heats up. 'Please select product:' appears on the display.

Cleaning the machine

After 200 preparations or 80 switch-on rinses, the IMPRESSA will prompt you to clean it.

CAUTION

If the wrong cleaning agent is used, the machine could be damaged and/or traces could be left behind in the water.

- ▶ Use only original JURA maintenance products.

- i** The cleaning programme lasts approximately 20 minutes.
- i** Do not interrupt the cleaning programme. The quality of cleaning will be impaired if you do so.
- i** JURA cleaning tablets are available from stockists.

Precondition: 'Clean machine' is displayed.

- P** ▶ Press the P button.

'Maintenance status (1/6)'

- ▶ Press the 'Clean' button.

'Clean'

- i** If you do not want to start cleaning just yet, press the 'L' button. The prompt 'Clean machine' remains active.

- ▶ Press the 'Next' button.

'Empty coffee grounds container'

- ▶ Empty the drip tray and coffee grounds container and put them back into the machine.

'Please press the Rotary Switch.'

- ▶ Place one receptacle under the coffee spout and another under the cappuccino frother.



- ▶ Press the Rotary Switch.

'Machine is being cleaned.', water flows out of the coffee spout.

The operation is interrupted, 'Add cleaning tablet'.

- ▶ Open the cover of the filler funnel for ground coffee.

- ▶ Insert a JURA cleaning tablet into the filler funnel.

- ▶ Close the cover of the filler funnel.

'Please press the Rotary Switch.'



- ▶ Press the Rotary Switch.
 ‘Machine is being cleaned.’, water flows repeatedly out of the coffee spout and the cappuccino frother.
 The operation is interrupted, ‘Empty coffee grounds container’.
- ▶ Empty the drip tray and coffee grounds container and put them back into the machine.
 Cleaning is now complete. The IMPRESSA is once more ready for use.

Descaling the machine

The IMPRESSA builds up deposits of limescale over time and automatically prompts you to descale it when necessary. The degree of calcification depends on the hardness of your water.

-
- ⚠ CAUTION** If the descaling agent comes into contact with the skin or eyes, this can cause irritation.
- ▶ Avoid contact with the skin or eyes.
 - ▶ Rinse off descaling agent with clean water. Should you get any descaling agent in your eye, see a doctor.
-
- CAUTION** If the wrong descaling agent is used, the machine could be damaged and/or traces could be left behind in the water.
- ▶ Use only original JURA maintenance products.
-
- CAUTION** If the descaling operation is interrupted, there may be damage to the machine.
- ▶ Allow the descaling programme to run to the end.
-
- CAUTION** If the descaling agent comes into contact with sensitive surfaces (e.g. marble), damage cannot be ruled out.
- ▶ Clean up any splashes immediately.
-
- i** The descaling programme lasts approximately 45 minutes.
 - i** JURA descaling tablets are available from stockists.
 - i** If you use a CLARIS Blue filter cartridge and this is activated, you will not be prompted to descale.

Precondition: 'Decalcify machine' is displayed.

- P** ▶ Press the P button.
'Maintenance status (1/6)'
- ▶ Press the 'Descale' button.
'Descale'

i If you do not want to start descaling just yet, press the 'L' button. The prompt 'Decalcify machine' remains active.

- ▶ Press the 'Next' button.
'Empty drip tray'
- ▶ Empty the drip tray and coffee grounds container and put them back into the machine.
'Pour descaling agent into water tank.'
- ▶ Remove and empty the water tank.
- ▶ Completely dissolve the contents of one blister (three JURA descaling tablets) in a receptacle holding 500 ml of water. This may take several minutes.
- ▶ Pour the solution into the empty water tank and insert it into the machine.

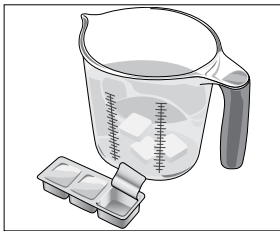

- ▶ Pour the solution into the empty water tank and insert it into the machine.
'Please press the Rotary Switch.'
- ▶ Remove the cappuccino frother.
- ▶ Place a receptacle (at least 500 ml) under the connector of the cappuccino frother.
- ▶ Press the Rotary Switch.



- ▶ Press the Rotary Switch.
'Machine is being descaled.', water flows repeatedly out of the connector of the cappuccino frother. The operation stops automatically, 'Empty drip tray'.
- ▶ Empty the receptacle under the connector of the cappuccino frother.
- ▶ Empty the drip tray and coffee grounds container and put them back into the machine.
'Fill water tank'
- ▶ Remove the water tank and rinse it thoroughly.
- ▶ Fill the water tank with fresh, cold water and reinsert the tank.
'Please press the Rotary Switch.'
- ▶ Refit the cappuccino frother.



- ▶ Place a receptacle under the cappuccino frother and another under the coffee spout.
 - ⏻ ▶ Press the Rotary Switch.
 'Machine is being descaled.', water flows out of the cappuccino frother and the coffee spout.
 'Machine is heating.', 'Machine is rinsing.', water flows out of the coffee spout.
 The operation stops automatically, 'Empty drip tray'.
 - ▶ Empty the drip tray and coffee grounds container and put them back into the machine.
 Descaling is now complete. The IMPRESSA is once more ready for use.
- i** If the descaling operation stops unexpectedly, rinse the water tank thoroughly.

Cleaning the bean container

Coffee beans may be covered with a slight oil film which remains on the walls of the bean container. These traces may negatively affect the coffee result. For this reason clean the bean container from time to time.

Precondition: 'Fill bean container' is displayed.

- ⏻ ▶ Switch the machine off with the On/Off button.
- ⏻ ▶ Switch the machine off at the power switch.
- ▶ Open the bean container cover and remove the aroma preservation cover.
- ▶ Clean the bean container with a soft, dry cloth.
- ▶ Fill the bean container with coffee beans, then close the aroma preservation cover and the bean container cover.

Descaling the water tank

Limescale deposits may form in the water tank. To ensure correct function of the machine, descale the water tank from time to time.

- ▶ Remove the water tank.
- ▶ If you use a CLARIS Blue filter cartridge, remove this.
- ▶ Descale the tank with a mild conventional descaling agent in accordance with the manufacturer's instructions.
- ▶ Rinse out the water tank thoroughly.
- ▶ If you use a CLARIS Blue filter cartridge, insert this again.
- ▶ Fill the water tank with fresh, cold water and reinsert the tank.

6 Display messages

Message	Cause/Result	Action
'Fill water tank'	The water tank is empty. You cannot prepare any products.	▶ Fill the water tank (see Chapter 1 'Preparing and using for the first time – Filling the water tank').
'Empty coffee grounds container'	The coffee grounds container is full. You cannot prepare any products.	▶ Empty the coffee grounds container and the drip tray (see Chapter 3 'Daily operation – Daily maintenance').
'Empty drip tray'	The drip tray is full. You cannot prepare any products.	▶ Empty the drip tray. ▶ Clean and dry the metal contacts on the back of the drip tray.
'Drip tray not fitted'	The drip tray is not inserted correctly or is not inserted at all. You cannot prepare any products.	▶ Fit the drip tray.
'Please press the Rotary Switch.'	The IMPRESSA is prompting you to perform a rinse or continue a maintenance programme that was already started.	▶ Press the Rotary Switch to start the rinse or to continue the maintenance programme.
'Fill bean container'	The bean container is empty. You cannot prepare any products.	▶ Fill the bean container (see Chapter 1 'Preparing and using for the first time – Filling the bean container').
'Rinse the milk system'	The IMPRESSA is prompting you to rinse the milk system.	▶ Press the Rotary Switch to start rinsing the milk system.
'Change filter'	The filter cartridge no longer works.	▶ Replace the CLARIS Blue filter cartridge (see Chapter 5 'Maintenance – Changing the filter').
'Clean machine'	The IMPRESSA is prompting you to clean it.	▶ Perform cleaning (see Chapter 5 'Maintenance – Cleaning the machine').
'Decalcify machine'	The IMPRESSA is prompting you to descale it.	▶ Perform descaling (see Chapter 5 'Maintenance – Descaling the machine').
'Not enough ground coffee'	There is insufficient ground coffee in the machine; the IMPRESSA stops the operation.	▶ The next time you prepare a beverage, add more ground coffee (see Chapter 2 'Preparation – Ground coffee').

7 Troubleshooting

Problem	Cause/Result	Action
When preparing a latte macchiato, the typical three layers do not form.	–	<ul style="list-style-type: none"> ▶ Turn the setting wheel of the cappuccino to the far right and the Milk Foam position . ▶ Change the length of the interval to at least 30 seconds in programming mode (see Chapter 4 ‘Permanent settings in programming mode – Product settings’).
Insufficient foam is produced when the milk is frothed or milk sprays from the cappuccino frother.	The cappuccino frother is dirty.	<ul style="list-style-type: none"> ▶ Rinse and clean the cappuccino frother (see Chapter 5 ‘Maintenance – Rinsing the cappuccino frother’). ▶ Check that the air intake pipe is fitted on the cappuccino frother. ▶ Rinse or replace the air intake pipe. You will find a replacement in the Welcome Pack.
Coffee only comes out in drips when it is being prepared.	Coffee or ground coffee has been ground too finely and is blocking the system. The same filter cartridge may have been used several times or the water hardness set incorrectly in the programming mode.	<ul style="list-style-type: none"> ▶ Put the grinder on a coarser setting or use coarser ground coffee (see Chapter 1 ‘Preparing and using for the first time – Adjusting the grinder’). ▶ Perform descaling (see Chapter 5 ‘Maintenance – Descaling the machine’).
Water hardness cannot be adjusted.	The CLARIS Blue filter cartridge is activated.	<ul style="list-style-type: none"> ▶ Deactivate the filter cartridge in programming mode.
‘Fill bean container’ is not displayed although the bean container is empty.	The bean monitor is dirty.	<ul style="list-style-type: none"> ▶ Clean the bean container (see Chapter 5 ‘Maintenance – Cleaning the bean container’).
‘Empty drip tray’ is always displayed.	The metal contacts of the drip tray are dirty or wet.	<ul style="list-style-type: none"> ▶ Clean and dry the metal contacts on the back of the drip tray.

7 Troubleshooting

Problem	Cause/Result	Action
'Fill water tank' is displayed although the water tank is full.	The water tank float is trapped.	▶ Descale the water tank (see Chapter 5 'Maintenance – Descaling the water tank').
Little or no water or steam comes out of the cappuccino frother. The pump is very quiet.	The connector of the cappuccino frother may be blocked by milk residues or limescale fragments loosened during descaling.	<ul style="list-style-type: none"> ▶ Remove the cappuccino frother. ▶ Unscrew the black connector with the aid of the hexagonal hole on the measuring spoon for ground coffee. ▶ Clean the connector thoroughly. ▶ Screw the connector back on by hand. ▶ Carefully tighten it using the hexagonal hole on the measuring spoon, turning by no more than a quarter of a rotation.
Grinder is making a very loud noise.	There are foreign objects in the grinder.	▶ Contact customer support in your country (see Chapter 11 'JURA contact details / Legal information').
'ERROR 2' is displayed.	If the machine was exposed to the cold for a long period of time, heating is disabled for safety reasons.	▶ Warm the machine at room temperature.
Other 'ERROR' messages are displayed.	–	▶ Switch the IMPRESSA off at the power switch. Contact customer support in your country (see Chapter 11 'JURA contact details / Legal information').

i If you were unable to solve the problem, contact customer support in your country (see Chapter 11 'JURA contact details / Legal information').

8 Transport and environmentally friendly disposal

Transport / Emptying the system

In order to protect the IMPRESSA from frost during transport, the system must be emptied.



Precondition: 'Please select product:' is displayed.

- ▶ Carefully pull the cappuccino frother down and off.
- ▶ Place a receptacle under the connector of the cappuccino frother.
- ▶ Press the '1 portion milk' button.
'Machine is heating.'
- As soon as the machine has heated up, 'Please select product:' appears.
- ▶ Press the '1 portion milk' button again.
'1 portion milk', hot steam is discharged from the connector.
- ▶ Remove and empty the water tank.
- ⌚ ▶ Turn the Rotary Switch until '60 sec.' is displayed.
Steam will continue to be discharged from the connector until the system is empty.
'Fill water tank'
- ⏻ ▶ Press the On/Off button.
The IMPRESSA is switched off.

Disposal

Please dispose of old machines in an environmentally neutral way.



Old machines contain valuable, recyclable materials which should be recycled. Please therefore dispose of old machines via suitable collection systems.

9 Technical data

Voltage	220–240 V ~, 50 Hz
Power	1450 W
Safety test	Ⓢ
Energy consumption 'Save energy' / 'Active'	Approx. 5 Wh
Energy consumption 'Save energy' / 'Inactive'	Approx. 12 Wh
Pump pressure	Static, max. 15 bar
Holding capacity of water tank	2.1 l
Holding capacity of bean container	250 g
Holding capacity of coffee grounds container	Max. 16 portions
Cable length	Approx. 1.1 m
Weight	10.9 kg
Dimensions (W × H × D)	28.5 × 34.2 × 43.3 cm

10 Index

A

- Addresses 48
- Automatic switch-off 28

B

- Bean container
 - Bean container with aroma preservation cover 4
 - Cleaning 39
 - Filling 10
- Bus bar
 - Technical data 44
- Button
 - On/Off button 5
 - P button (programming) 5

C

- Cappuccino 18
- Cappuccino frother
 - Cleaning 33
 - Rinsing 33
- CLARIS Blue filter cartridge
 - Changing 34
 - Inserting and activating the filter 12
- Cleaning
 - Bean container 39
 - Cappuccino frother 33
 - Machine 36
- Coffee 17
- Coffee grounds container 4
- Coffee spout
 - Height- and width-adjustable coffee spout 4
- Consistency of grind
 - Adjusting the grinder 15
 - Grinder adjustment switch 4
- Contact details 48
- Cover
 - Bean container 4
- Cup platform 4
- Customer support 48

D

- Degree of water hardness 13
- Descaling
 - Machine 37
 - Water tank 39
- Determining and adjusting the water hardness 13
- Display 5
- Display messages 40
- Drip tray 4

E

- Emptying the system 43
- Energy-saving mode 27
- Errors
 - Troubleshooting 41
- Espresso 17

F

- Factory settings
 - Restore factory settings 29
- Filler funnel
 - Filler funnel for ground coffee 4
- Filling
 - Bean container 10
 - Water tank 10
- Filter
 - Changing 34
 - Inserting and activating the filter 12
- First-time use 11
- Frother
 - Cappuccino frother 4

G

- Ground coffee 19

H

- Hotline 48
- Hot water 21
- Hot-water nozzle 4

- I**
 - Instant coffee
 - Ground coffee 19
 - Internet 10
- J**
 - JURA
 - Contact details 48
 - Internet 10
- L**
 - Language 30
 - Latte macchiato 18
- M**
 - Machine
 - Cleaning 36
 - Descaling 37
 - Rinsing 32
 - Setting up 10
 - Switching off 23
 - Switching on 22
 - Mains cable 4
 - Maintenance
 - Daily maintenance 22
 - Maintenance 32
 - Messages, display 40
 - Milk foam 19
 - Milk system cleaning
 - Cappuccino frother cleaning 33
 - Milk system rinse
 - Rinsing the cappuccino frother 33
 - Milk, warm 19
- P**
 - Permanently setting the water for the cup size 20
 - Permanent settings in programming mode 24
 - Power switch 4
 - Preparation 16, 18
 - Cappuccino 18
 - Coffee 17
 - Espresso 17
 - Ground coffee 19
 - Latte macchiato 18
 - Milk 19
 - Problems
 - Troubleshooting 41
 - Programming mode 24
 - Automatic switch-off 28
 - Energy-saving mode 27
 - Language 30
 - Maintenance settings 26
 - Product settings 25
 - Restore factory settings 29
 - Unit for amount of water 29
 - Proper use 6
- R**
 - Rinsing
 - Cappuccino frother 33
 - Machine 32
 - Rotary Switch 5

S

- Safety 6
- Safety information 6
- Settings
 - Permanent settings in programming mode 24
- Setting up
 - Setting up the machine 10
- Short operating instructions 10
- Switching off 23
- Switching on 22
- Switch-off
 - Automatic switch-off 28
- Symbol description 3

T

- Technical data 44
- Telephone 48
- Troubleshooting 41

U

- Unit for amount of water 29
- Use, First-time 11

V

- Viewing information 31

W

- Warm milk 19
- Water tank 4
 - Descaling 39
 - Filling 10
- Website 10

11 JURA contact details / Legal information

JURA Elektroapparate AG
Kaffeeweltstrasse 10
CH-4626 Niederbuchsiten
Tel. +41 (0)62 38 98 233

@ You will find additional contact details for your country at www.jura.com.

Directives The machine complies with the following directives:

- 2006/95/EC – Low Voltage Directive
- 2004/108/EC – Electromagnetic Compatibility
- 2009/125/EC – Ecodesign
- 2011/65/EU – RoHS Directive

Technical changes We reserve the right to make technical changes. The diagrams used in these instructions for use are for illustration purposes only and do not represent the original colours of the machine. Some details of your IMPRESSA may vary.

Feedback Your opinion is important to us! Use the contact link at www.jura.com.

Copyright The instructions for use contain information which is protected by copyright. It is not permitted to photocopy these instructions for use or translate them into another language without the prior written consent of JURA Elektroapparate AG.