

# Panasonic

## Operating Instructions Portable Oral Irrigator Model No. EW-DJ10



---

---

<b>English</b>	<b>2</b>	<b>Dansk</b>	<b>80</b>	<b>Česky</b>	<b>154</b>
<b>Deutsch</b>	<b>14</b>	<b>Português</b>	<b>92</b>	<b>Slovensky</b>	<b>166</b>
<b>Français</b>	<b>28</b>	<b>Norsk</b>	<b>105</b>	<b>Magyar</b>	<b>178</b>
<b>Italiano</b>	<b>41</b>	<b>Svenska</b>	<b>117</b>	<b>Română</b>	<b>191</b>
<b>Nederlands</b>	<b>54</b>	<b>Suomi</b>	<b>129</b>	<b>Türkçe</b>	<b>204</b>
<b>Español</b>	<b>67</b>	<b>Polski</b>	<b>141</b>		

Before operating this product, please read the instructions carefully, and save this manual for future use.

## Safety Instructions

All information in this section is provided to instruct you in the correct and safe operation of this appliance so that you can avoid injuries to yourself and others as well as damage to property.

- **The harm or damage that is caused by improper use is described in categories.**

### **Warning**

This indicates “content that may cause death or severe injury”.

### **Caution**

This indicates “content that may cause injury or damage to property”.

- **Content to be observed is described with the following icons. (The following are examples of icons)**

 A circle and slash symbolizes prohibited actions and behaviors.

 A solid circle denotes mandatory actions and instructions to be followed for safe operation.

### **Warning**

#### **Mandatory!**

- **Keep out of the reach of toddlers and infants.**

Failure to do so could result in accidents or trouble, such as an accidental ingestion of the accessories or the parts that can be taken apart.

### **Caution**

#### **Prohibited**

- **Toddlers, infants, people who are unable to operate and people with weak oral senses should not use this appliance.**

Failure to do so could result in injury.

- **Do not use for any purpose other than oral cleaning.**

Doing so could result in injury when the stream of water is pointed toward the eyes, nose, ears, or throat. Consult the dentist if you are receiving oral treatments or have severe periodontal disease.

- **Do not fill the tank with water warmer than 40 °C.**



Doing so could result in burns.

**! Mandatory!**

- **Keep the appliance sanitized and use fresh tap water or warm water when cleaning the mouth.**
- **Make sure to throw out the water inside the tank, and run the appliance for 2 to 3 seconds to drain the water after usage.**

Failure to do so could result in damage to your health if used without keeping it sanitized due to propagation of mold and bacteria. It may also result in odor and malfunction.

- **Observe the caution written on the batteries.**
- **Insert the batteries correctly checking the + and - terminals.**
- **Remove used batteries immediately.**
- **Remove the batteries when the appliance is not to be used for a long period.**
- **Use the batteries by the recommended use-by date.**

Failure to do so may cause overheating or explosion of the batteries, injury or contamination of surroundings due to leakage.

**🚫 Do not dismantle!**

- **Never alter the appliance. Also, do not disassemble or repair it.**

Doing so could result in fire, electric shock, or injury.

## Caution

- This appliance is not intended for use by persons (including children) with reduced physical, sensory or mental capabilities, or lack of experience and knowledge, unless they have been given supervision or instruction concerning use of the appliance by a person responsible for their safety.  
Children should be supervised to ensure that they do not play with the appliance.

## Parts identification

English

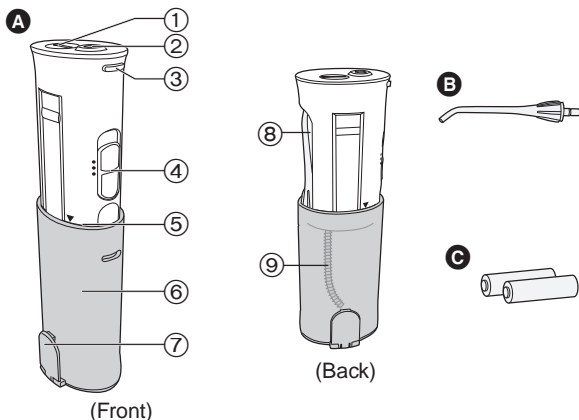

### A Main unit

- ① Battery cover
- ② Nozzle socket
- ③ Nozzle release button
- ④ Switch
- ⑤ Usage line (▼ mark)
- ⑥ Tank

- ⑦ Water supply cap

- ⑧ Nozzle storage compartment

- ⑨ Water suction tube

### B Nozzle (x1)

- C AA size alkaline battery (x2)

### ► Note

There may be some liquid remaining inside the main appliance (tank, water suction tube, etc.), but this is remaining distilled water that was used for the performance (water flow) test, so there are no health concerns.

### ► Before using the appliance

Initially bleeding may occur even with healthy gums. This is caused because the gums are not used to such stimulation. The bleeding will normally stop within 1 or 2 weeks of use. There may be a problem with the gums (periodontal disease, etc.) if the bleeding continues for over 2 weeks. In such cases, stop using the appliance and consult the dentist.

## Insert the alkaline batteries

- Wipe the appliance so no water goes inside.

### 1 Open the battery cover by turning it to OPEN.

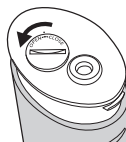

### 2 Insert two AA size alkaline batteries.

- Please use Panasonic alkaline batteries (AA size).  
(It can be used for approximately 30 times full tank usage, or approximately 20 minutes of continuous usage.)
- Do not use rechargeable batteries.  
Doing so may result in the leakage of the battery leading to malfunction.

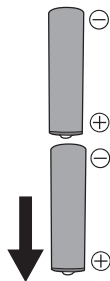

### 3 Close the battery cover by turning it to CLOSE.

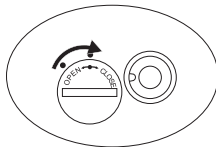

## Using the appliance

English

- Use with tap water or lukewarm water.
- Do not turn the switch to ON before placing the nozzle in your mouth.

**1** Open the water supply cap.

**2** Pull out the white part of main unit up to the usage line (▼ mark).

- It may be hard to pull out the main unit with the water supply cap closed.
- Water pressure will not rise unless the main unit is pulled out to the usage line.
- Be careful since the nozzle might pop out from the storage compartment at this time.

**3** Insert the nozzle into the nozzle socket holding onto the white part of the main unit.

- Insert it securely until it clicks.

**4** Pour in water.

- Always use fresh tap water.
- If the water feels cold, use lukewarm water of up to 40 °C.
- Do not pour in salt, toothpaste, or chemicals.
- To continuously use, make sure the switch is set to OFF.

**5** Close the water supply cap.

- Securely close after pouring in water.

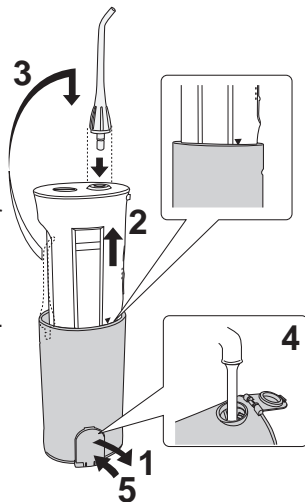



## 6 Place the nozzle in your mouth.

- The water suction tube inside the tank may come out from the water and the flow of the water may stop when the appliance is tilted too much.

## 7 Turn the switch to ON.

- It can be used for approximately 40 seconds with a full tank.

Mode (strength) can be selected.

### 2 (Normal)

- For normal cleaning

### 1 (Soft)

- When you are worried about your gums
- When you feel 2 (Normal) is too strong

- Do not press the tip of the nozzle hard against the teeth or gums.
- Be extra cautious with those who cannot operate the appliance by themselves, such as infants or toddlers, or people with high oral sensitivity.
- Do not drop or handle it roughly.
- Do not operate when the tank is empty except to drain the water from the appliance. Doing so could result in malfunction.

### ► Tips

- Hold the appliance vertically with the nozzle upward.
- Move your face above the sink.
- Close your mouth slightly so the water will not splatter.
- Place the nozzle in your mouth.

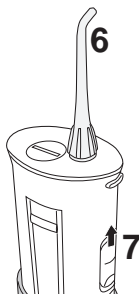

## Cleaning your mouth well

English

- Aim the stream as perpendicular as possible between the teeth or the edge between the teeth and gums.
- Move slowly along the teeth.
- Take extra care between the teeth and around braces.

### Front side of the teeth...

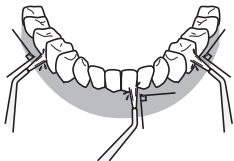

- Apply the stream perpendicular to the teeth.
- Take extra care between the teeth and the edge between the teeth and gums.

### Back side of the teeth...

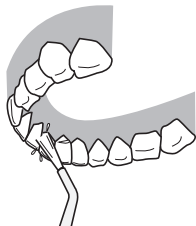

#### For the upper teeth

- Adjust the angle of the nozzle to face upward, and apply the stream perpendicular to the teeth.

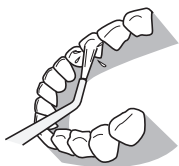

#### For the lower teeth

- Pull your chin down, and apply the stream perpendicular to the teeth.

- Do not apply the stream directly into the periodontal pockets.

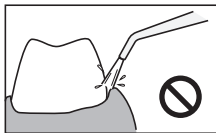
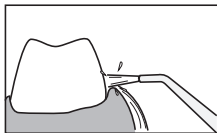



## After using the appliance

- There is a risk of bacteria propagating, so wash thoroughly and dry before storing.

- 1** Open the water supply cap and dispose of the water in the tank.



- 2** Turn the switch to ON, and drain the water inside the appliance.

- Run the appliance for 2 to 3 seconds until no water comes out.



- 3** Turn the switch to OFF.

- 4** Press the nozzle release button, remove the nozzle and place it in the storage compartment.

- 5** Store the main unit.

- Press it in until it clicks.
- Watch out not to clamp your fingers in the upper part of the tank.

- 6** Close the water supply cap.

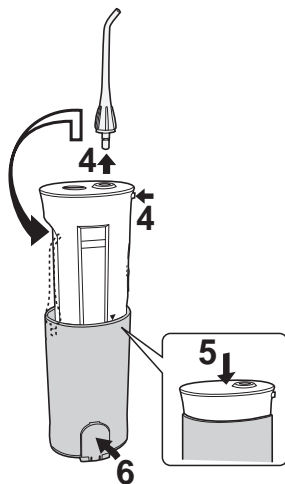

- To store in a bag or similar after using the appliance, wrap it in a towel or similar to absorb any excess water.
- To prevent bacteria propagating, take it out from a bag or similar as soon as possible to dry.

## Maintenance

### a Nozzle

(Remove it while pressing the nozzle release button.)

Wash with water and wipe with a cloth.

- Please replace the nozzle about once every 6 months. If the tip of nozzle gets deformed, please replace with a new nozzle. Failure to do so could result in malfunction.

### b Main unit

Remove the dirt by wiping using a cloth with liquid soap, and wipe off using a dry cloth.

Wash with water if it is very dirty.

- Do not wipe the appliance with thinners, benzine, alcohol etc.
- Doing so could result in malfunction, cracking or discoloration of the parts.
- Do not wash using hot water of over 50 °C.
- Make sure the battery cover is securely closed.
- Do not leave the appliance submerged in water.
- Dry after washing with water.

### c Water suction tube

Wash with water and wipe with a cloth.

- Do not bend the water suction tube.
- Failure to do so could result in malfunction such as disruption in the operation of the water suction tube.

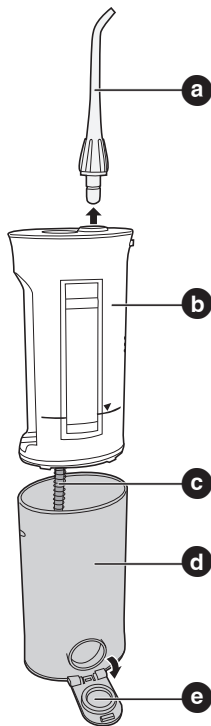

**d** Tank

It will come off when the body is pulled hard while the water supply cap is removed, so perform maintenance of interior as well.

Wash with water and wipe with a cloth.

- Wash the dirt off from inside using a brush or similar, and wipe off with a cloth.
- Dry the tank when not using for a long period.

**e** Water supply cap

Wipe off any grime and dirt.

- Failure to do so could result in water leakage.

- Only use mild detergent.
- Never use thinners, benzene, or alcohol since it may cause malfunction or cracking / discoloration of the parts.

## If you think it is malfunctioning

Check the following.

Symptom	Probable Cause	Action
<b>It does not operate even when the switch is turned on</b>	Batteries are not inserted correctly	Insert the batteries correctly
	Batteries are dead	Replace with new batteries
Symptom	Probable Cause	Action
<b>Water pressure is low</b>	There is dirt stuck in the nozzle	Replace the nozzle
	Mouth of the nozzle is squashed	

Symptom	Probable Cause	Action
<b>Water does not come out</b>	The appliance is tilted too much while in use	Use with the appliance in a vertical state
	The main unit is not fully extended.	Pull out the main unit all the way

If the problem remains even after the appliance is checked and action is taken, terminate usage to prevent any accidents, and request checkup and repair at a store.

## Specifications

Power supply: 3 V DC (two 1.5 V alkaline batteries (AA/LR6))

Battery: AA size alkaline battery (x2)

Pump frequency: 1400 pulse/minute (at normal setting)

Water Pressure:

2 (Normal): 530 kPa (5.4 Kgf/cm<sup>2</sup>)

1 (Soft): 350 kPa (3.6 Kgf/cm<sup>2</sup>)

Operating time:

approx. 40 seconds/full tank or a total of approx. 20 minutes (at normal setting) (at using AA/LR6 alkaline batteries)

Tank volume: 165 ml

Dimensions:

218 (H) x 51 (W) x 68 (D) mm with tank pulled down

142 (H) x 51 (W) x 68 (D) mm with tank closed

Weight: approx. 210 g (without batteries)

Airborne Acoustical Noise: 71 (dB (A) re 1 pW)

Specifications to be changed without notice

## Accessories

Contact the stores close to you.

Check the “appliance product number (EW-DJ10)” and the “replacement nozzle product number” when purchasing.

Replacement nozzle (2 included)

### **EW0955**

With identification ring



## Information for Users on Collection and Disposal of Old Equipment and used Batteries



These symbols on the products, packaging, and/or accompanying documents mean that used electrical and electronic products and batteries should not be mixed with general household waste.

For proper treatment, recovery and recycling of old products and used batteries, please take them to applicable collection points, in accordance with your national legislation and the Directives 2002/96/EC and 2006/66/EC.

By disposing of these products and batteries correctly, you will help to save valuable resources and prevent any potential negative effects on human health and the environment which could otherwise arise from inappropriate waste handling.



For more information about collection and recycling of old products and batteries, please contact your local municipality, your waste disposal service or the point of sale where you purchased the items.



Penalties may be applicable for incorrect disposal of this waste, in accordance with national legislation.

**Cd**

### **For business users in the European Union**

If you wish to discard electrical and electronic equipment, please contact your dealer or supplier for further information.

### **[Information on Disposal in other Countries outside the European Union]**

These symbols are only valid in the European Union. If you wish to discard these items, please contact your local authorities or dealer and ask for the correct method of disposal.

### **Note for the battery symbol (bottom two symbol examples):**

This symbol might be used in combination with a chemical symbol. In this case it complies with the requirement set by the Directive for the chemical involved.

