



IceSLEET™ G4 series

Quick Start Guide

Iceberg-Thermal.com

Box Content

A

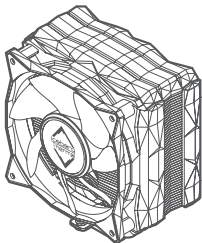

x 1

B



x 4

AMD

C



x 4

D



x 4

E

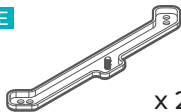

x 2

INTEL

F

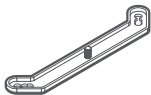

x 2

G



x 4

H

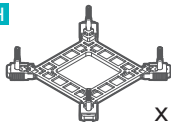

x 1

AMD

AM4

B



E



C

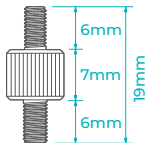

AM3(+)/AM2(+)/FM2(+)/FM1

B



E

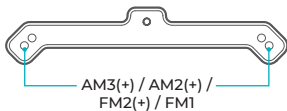

D

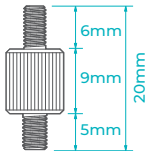

AMD

AM4

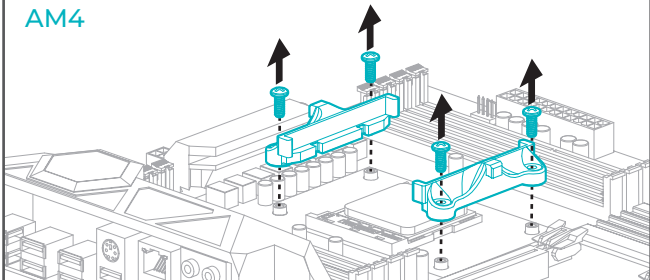

AM3(+) / AM2(+) / FM2(+) / FM1

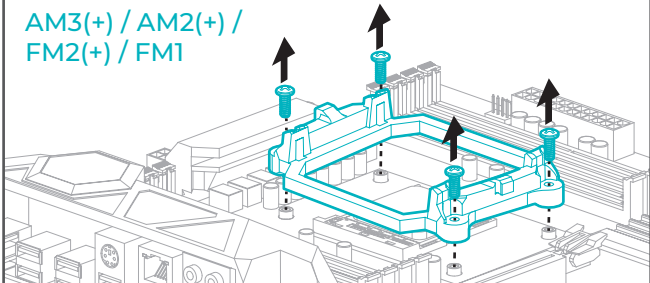

AMD

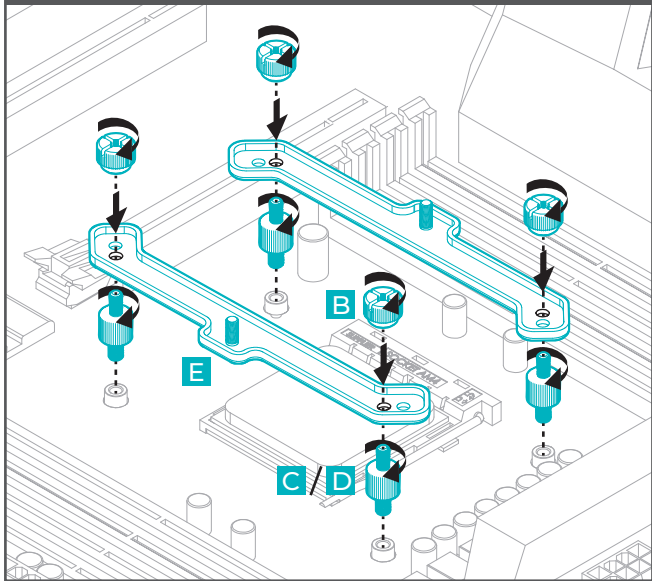

INTEL

B



F

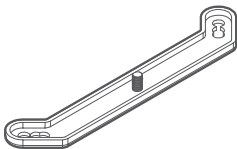

G



H

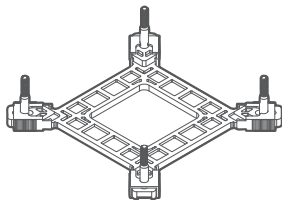

INTEL

F

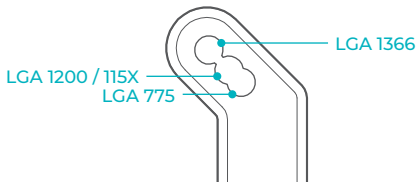

H

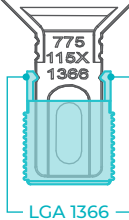
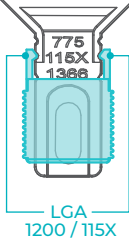
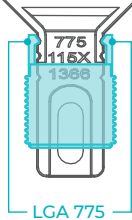

INTEL

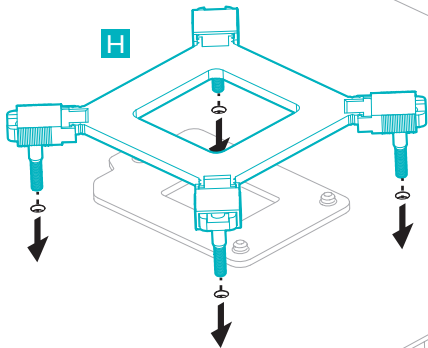

INTEL

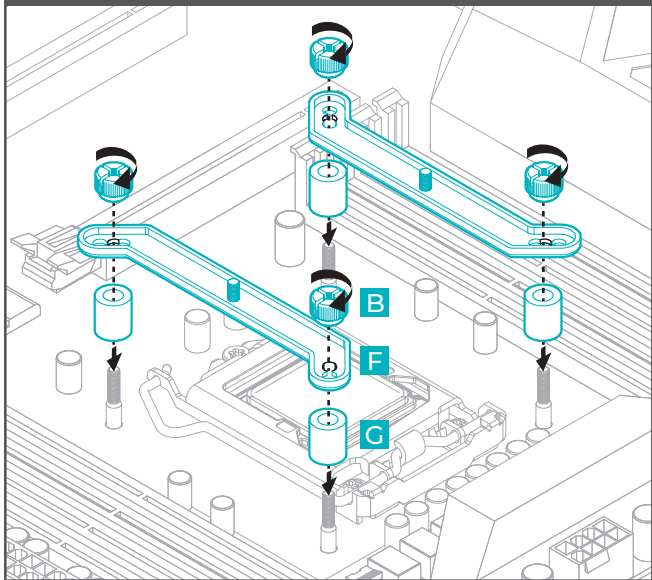

Step 1

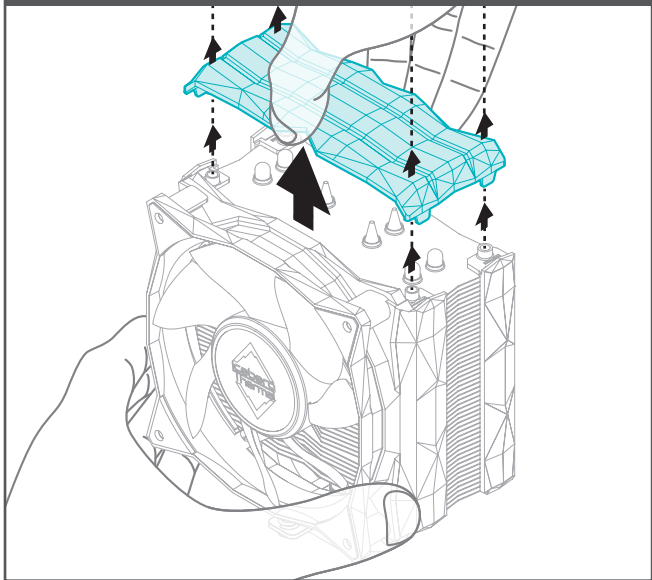

Step 2

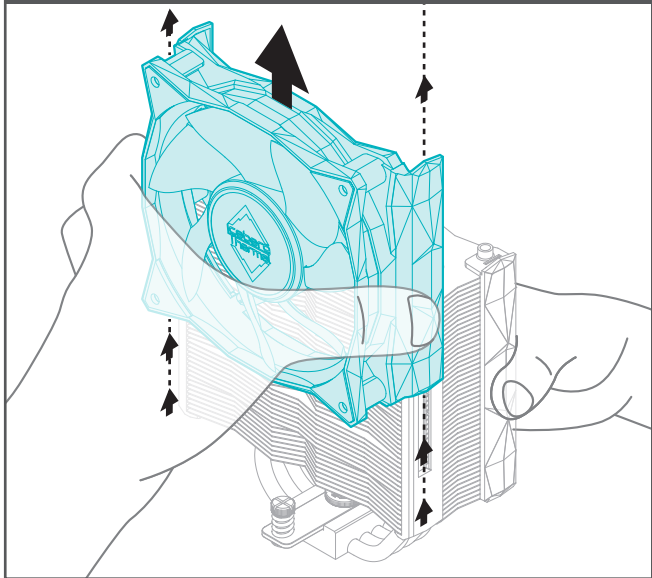

Step 3

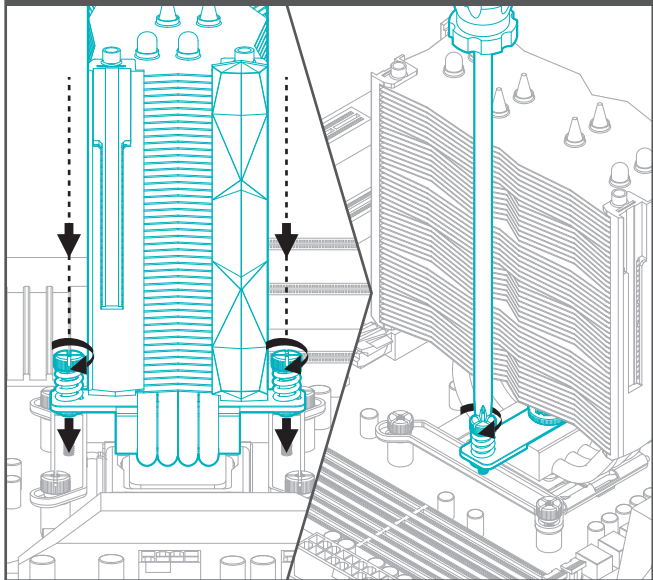

Step 4

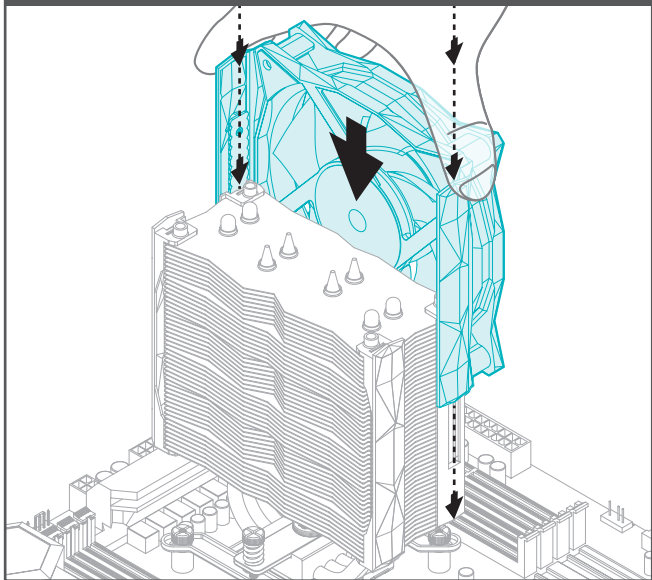

Step 5

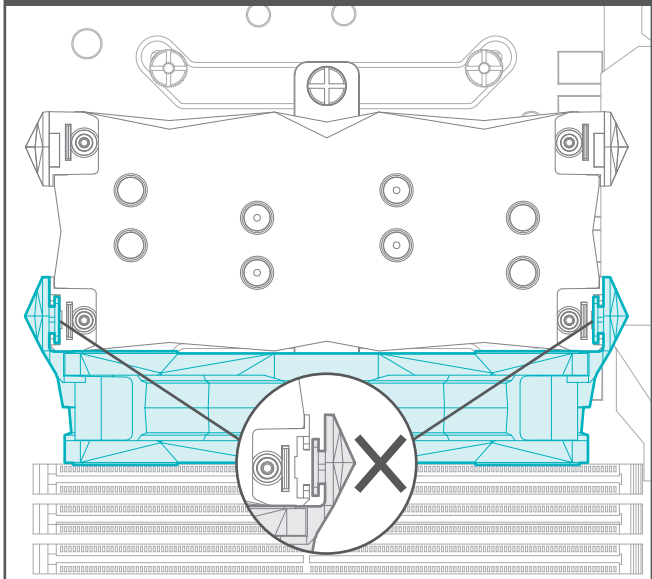

Step 6

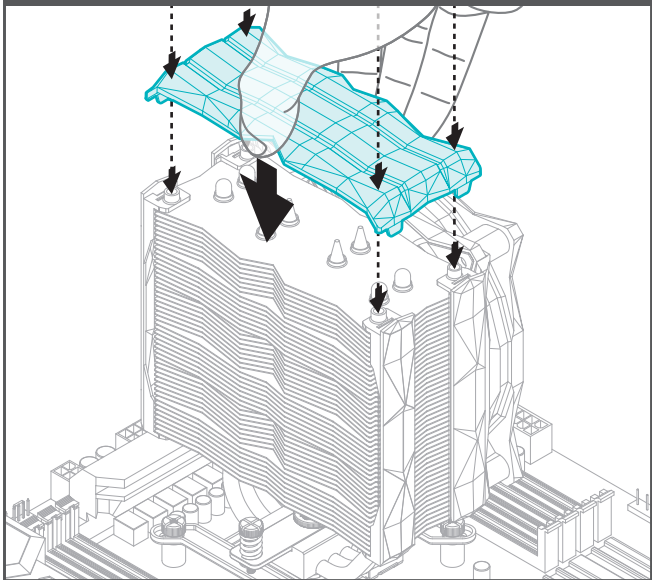

Step 7

