

QUICK START GUIDE

Installation Parts

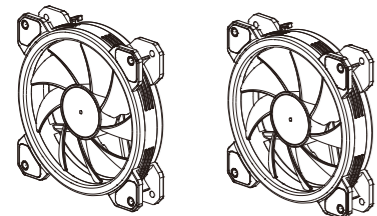

2 x 120mm ARGB PWM Fan

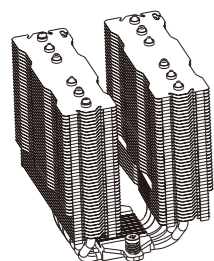

1 x Heatsink

1 x Intel Mounting Set

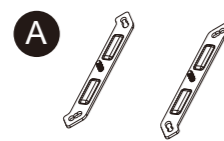

4 x Stand-Off Intel



1 x AMD Mounting Set

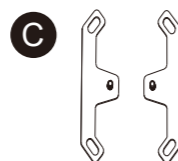

1 x Universal Backplate

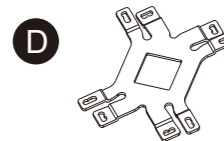

4 x Thumbscrew



4 x Screw



4 x Spacer



4 x Washer



1 x PWM Splitter



2 x Fan Mount Set



1 x GC-Extreme 1g - Thermal Paste



3 (LGA2011 Only) Fasten 4 x Stand-Off Intel B into the socket screw-holders.

4 Insert the 2 brackets of Intel Mounting Set A into 4 x Stand-Off Intel B (LGA2011) or 4 x Screw F (LGA775/1366/115x/1200).

5 Tighten 4 x Thumbscrew E on top.

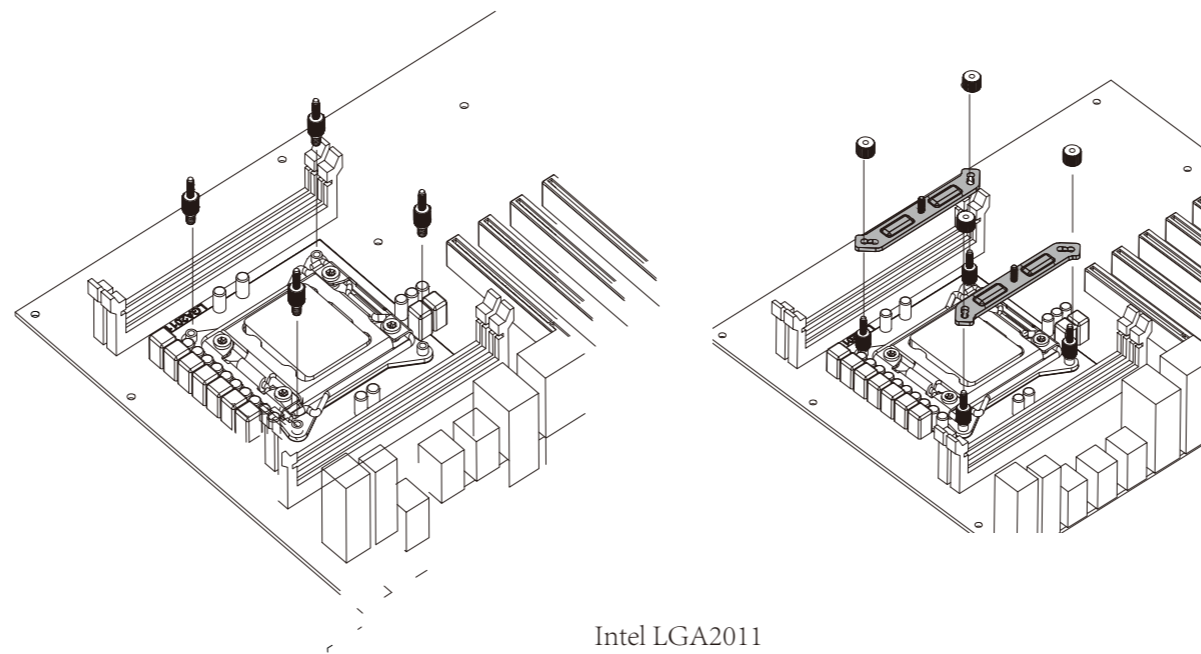

Intel LGA2011

9 Mount 2 x 120mm Fan by inserting 2 x Fan Mount Set J into the fan mounting holes and buckling in heatsink grooves.

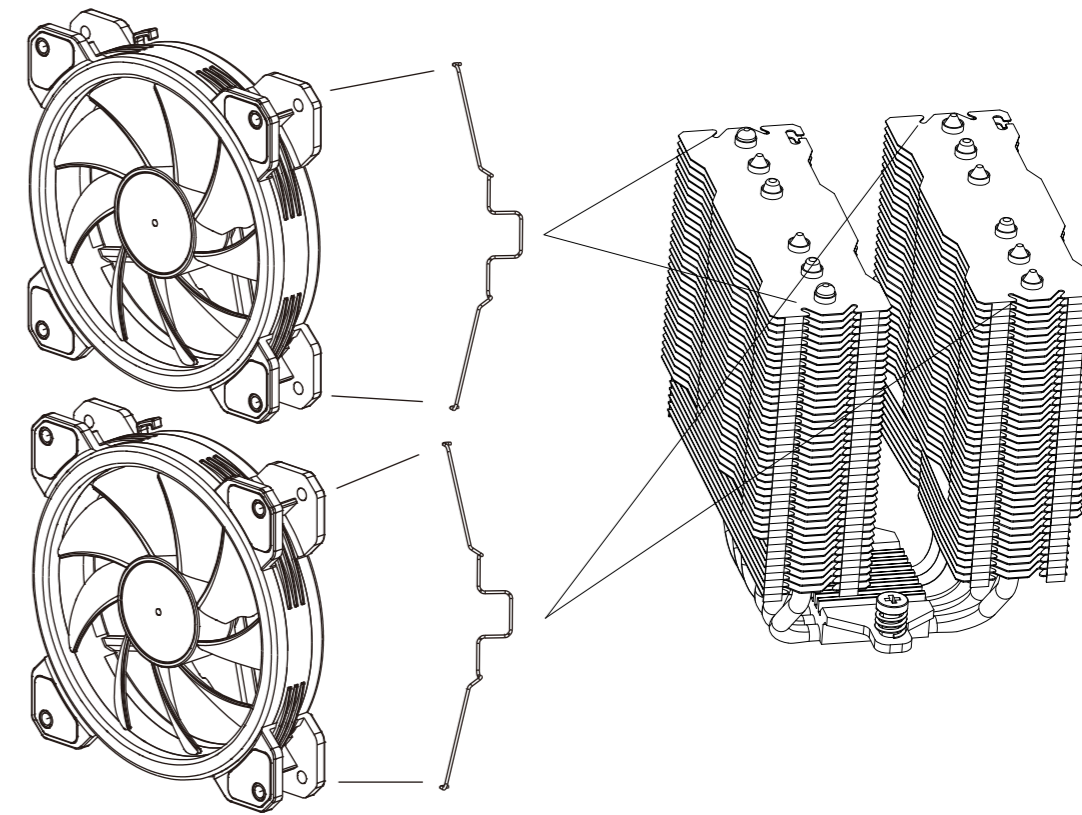

Installation Instructions

1 Insert 4 x Screw F into the screw holes of Universal Backplate D and fasten 4 x Washer H as shown.

2 Insert the Universal Backplate assembly from the motherboard backside and put 4 x Spacer G onto 4 x Screw F.

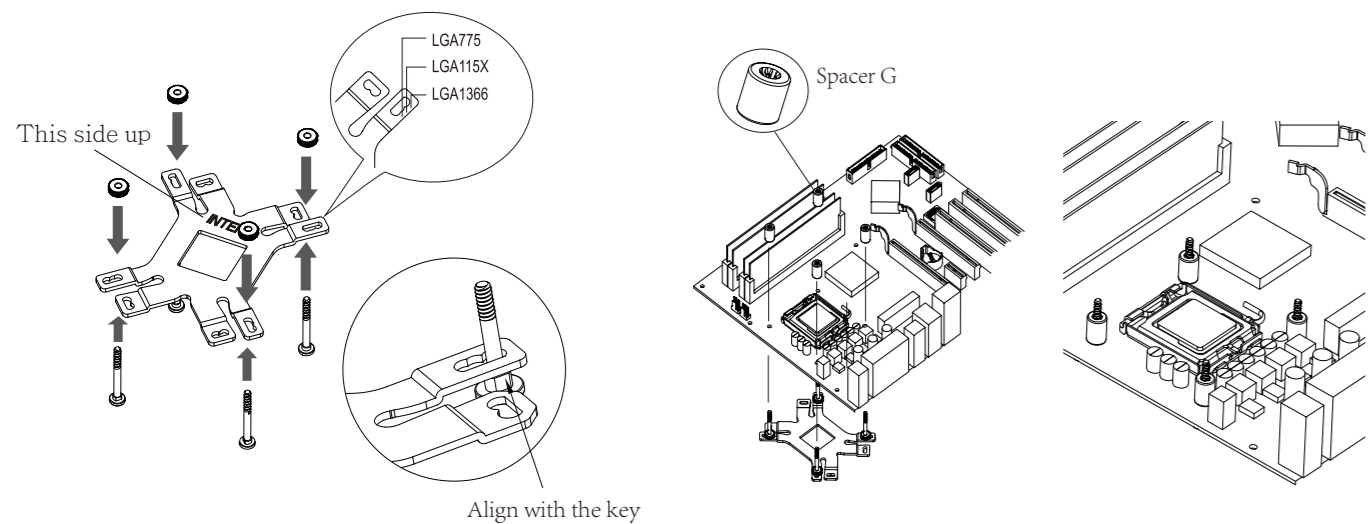

Intel LGA 775/1366/115x/1200

6 Apply Thermal Paste K on CPU surface (a small amount in centre is sufficient).

7 Peel off the protective film from the heatsink base.

8 Place the heatsink on top of CPU. Tighten the spring-screws with a screwdriver as shown.

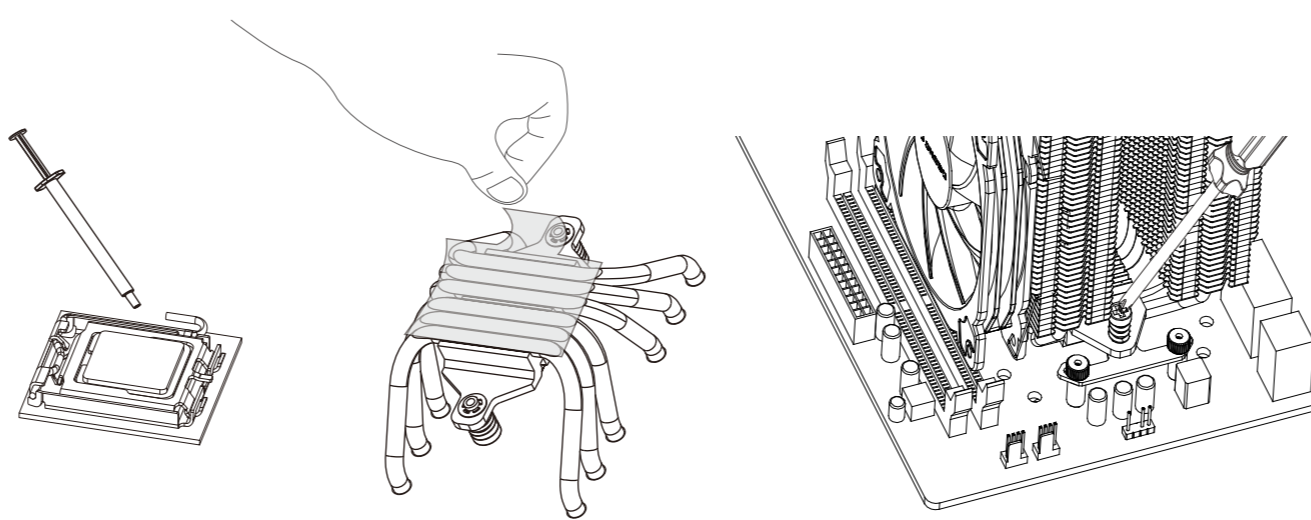

Limits of Warranty:

- Warranty coverage does not include the following:
- A faulty product that leads to harm or damage to other products
- Damage of product as a result of other product components
- Incorrect method of operation or use of product not for intended use
- Any form of alteration to original product
- Inability to install the product as a result of incompatibility with other components.

The Specifications are subject to change without notice.
Please consult our website for further information:
www.gelidsolutions.com

Disclaimer:

In no event shall GELID Solutions its directors or employees be liable for any indirect damages, incidental or consequential damages arising from any defect or error in this manual or product.

© Copyright 2020 All rights reserved by GELID Solutions Limited
All Brand names and Trademarks are the properties of their respective owners.

