



**Cat® S52**  
**User Manual**

## PLEASE READ BEFORE FIRST USE SAFETY PRECAUTIONS

- Please read this manual and the recommended safety precautions carefully to ensure the correct use of this device.
- If used in salt water, rinse the device afterwards, including the audio jack and the USB connector, to avoid salt corrosion.
- Despite its rugged nature; avoid hitting, throwing, crushing, puncturing or bending the device.
- Do not switch on the device in a circumstance when it is prohibited to use devices, or when it may cause interference or danger.
- Never use your device while driving.
- Always follow any device use rules in hospitals and health care facilities, and switch off near medical apparatus.
- Switch off the device or activate aeroplane mode when in an aircraft, as it may cause interference to the vessel's control equipment.
- Switch off your device near high-precision electronic devices as it may affect their performance.
- Do not attempt to disassemble your device or its accessories; only qualified personnel should service or repair it, if needed.
- Do not place the device or its accessories in containers with a strong electromagnetic field.
- Do not place magnetic storage media near the device. Radiation from the device may erase the information stored on it.
- Do not use the device in an environment with flammable gas, such as a gas station, or put the device in a high temperature place.
- Keep the device and its accessories away from young children. Do not allow children to use the device without guidance.
- Only use approved chargers to avoid the risk of explosion.
- Observe any laws or regulations on the use of wireless devices, respecting others' privacy and legal rights.
- For medical implant patients (heart, joints, etc), keep the device 15cm away from the implant and positioned on the opposite side of the implant.
- Strictly follow the relevant instructions of this manual while using the USB cable, otherwise your device or PC may be damaged.
- The full text of the safety instruction is available at the following internet address:  
<https://www.catphones.com/support/>

## LEGAL NOTICE

© 2019 Caterpillar. All Rights Reserved.

CAT, CATERPILLAR, LET'S DO THE WORK, their respective logos, "Caterpillar Yellow", the "Power Edge" and Cat "Modern Hex" trade dress as well as corporate and product identity used herein, are trademarks of Caterpillar and may not be used without permission.

Bullitt Mobile Ltd. is a licensee of Caterpillar Inc.

Bullitt Mobile Ltd.'s and third-party trademarks are the property of their respective owners.

No part of this document may be reproduced or transmitted in any form or by any means without prior written consent of Caterpillar Inc.

The product described in this manual may include copyrighted software and possible licensors. Customers shall not in any manner reproduce, distribute, modify, decompile, disassemble, decrypt, extract, reverse engineer, lease, assign, or sublicense the said software or hardware, unless such restrictions are prohibited by applicable laws or such actions are approved by respective copyright holders under licences.

The contents of this manual are provided "as is". Except as required by applicable laws, no warranties of any kind, either express or implied, including but not limited to the implied warranties of merchantability and fitness for a particular purpose, are made in relation to the accuracy, reliability or contents of this manual.

To the maximum extent permitted by applicable law, in no case shall the manufacturer be liable for any special, incidental, indirect, or consequential damages, or lost profits, business, revenue, data, goodwill or anticipated savings.

The Bluetooth® word mark and logos are registered trademarks owned by the Bluetooth SIG, Inc. and any use of such marks by Bullitt Group Ltd is under licence. All other third-party trademarks and trade names are those of their respective owners.

## NOTICE

Some features of the product and its accessories described herein rely on the software installed, capacities and settings of local network, and may not be activated or may be limited by local network operators or network service providers. Therefore, the descriptions in this manual may not exactly match the purchased product or its accessories.

The manufacturer reserves the right to change or modify any information or specifications contained in this manual without prior notice or obligation.

The manufacturer is not responsible for the legitimacy and quality of any products that you upload or download through this device including text, pictures, music, movies, and non-built-in software with copyright protection. Any consequences arising from the installation or usage of the preceding products on this device is accountable to you.

## **IMPORT AND EXPORT REGULATIONS**

Customers shall comply with all applicable export or import laws and regulations. Customers must obtain all necessary governmental permits and licences to export, re-export or import the product mentioned in this manual including the software and technical data.

# CONTENTS

<b>WELCOME TO THE CAT® S52</b> .....	<b>7</b>
<b>RUGGED CREDENTIALS</b> .....	<b>7</b>
<b>WHAT'S IN THE BOX</b> .....	<b>8</b>
<b>KEY FUNCTIONS</b> .....	<b>8</b>
<b>GETTING STARTED</b> .....	<b>9</b>
INSTALLING SIM CARD(S) AND MEMORY CARD .....	9
<b>CHARGING THE BATTERY</b> .....	<b>10</b>
<b>IMPORTANT INFORMATION REGARDING FUTURE USE OF THE BATTERY</b> .....	<b>10</b>
<b>POWERING YOUR DEVICE ON/OFF</b> .....	<b>10</b>
<b>TOUCHSCREEN</b> .....	<b>11</b>
<b>HOME SCREEN</b> .....	<b>11</b>
<b>LOCKING AND UNLOCKING THE SCREEN</b> .....	<b>11</b>
LOCKING THE SCREEN .....	11
UNLOCKING THE PHONE .....	11
<b>DISPLAY</b> .....	<b>12</b>
DISPLAY LAYOUT .....	12
NOTIFICATIONS AND STATUS INFORMATION .....	12
<b>NOTIFICATION PANEL</b> .....	<b>13</b>
<b>SHORTCUT ICONS</b> .....	<b>13</b>
<b>WIDGETS</b> .....	<b>14</b>
<b>FOLDERS</b> .....	<b>14</b>
<b>WALLPAPERS</b> .....	<b>14</b>
<b>TRANSFERRING MEDIA TO AND FROM YOUR DEVICE</b> .....	<b>15</b>
<b>USING FLIGHT MODE</b> .....	<b>15</b>
<b>MAKING A PHONE CALL</b> .....	<b>15</b>
<b>CONTACTS</b> .....	<b>16</b>
<b>USING THE ON-SCREEN KEYBOARD</b> .....	<b>18</b>
DISPLAYING THE KEYBOARD PANEL .....	18
USING THE LANDSCAPE KEYBOARD .....	18
CUSTOMISING YOUR KEYBOARD SETTINGS .....	18
<b>WI-FI®</b> .....	<b>18</b>
<b>SMS AND MMS</b> .....	<b>19</b>
<b>BLUETOOTH®</b> .....	<b>20</b>
<b>TAKING PHOTOS AND RECORDING VIDEOS</b> .....	<b>21</b>
<b>ENJOYING MUSIC</b> .....	<b>23</b>
<b>LISTENING TO FM RADIO</b> .....	<b>24</b>
<b>USING GOOGLE SERVICES</b> .....	<b>24</b>

<b>USING GOOGLE PLAY STORE .....</b>	<b>25</b>
<b>SYNCHRONISING INFORMATION .....</b>	<b>26</b>
<b>USING OTHER APPS .....</b>	<b>28</b>
<b>MANAGING THE DEVICE .....</b>	<b>29</b>
<b>SETTING THE DATE AND TIME .....</b>	<b>29</b>
<b>PERSONALISING THE DISPLAY .....</b>	<b>30</b>
<b>SETTING YOUR RINGTONE .....</b>	<b>30</b>
<b>SETTING PHONE SERVICES .....</b>	<b>31</b>
<b>USING NFC .....</b>	<b>31</b>
<b>PROTECTING THE DEVICE .....</b>	<b>31</b>
<b>MANAGING APPS.....</b>	<b>32</b>
<b>RESETTING THE DEVICE .....</b>	<b>33</b>
<b>APPENDIX .....</b>	<b>34</b>
VIEWING THE E-LABEL.....	34
PREVENTION OF HEARING LOSS.....	34
HEARING AID COMPATIBILITY (HAC).....	34
EMERGENCY CALL .....	35
CE SAR COMPLIANCE.....	35
FCC REGULATION .....	36
RF EXPOSURE INFORMATION (SAR) .....	36
DISPOSAL AND RECYCLING INFORMATION .....	37
REDUCTION OF HAZARDOUS SUBSTANCES.....	37
EU REGULATORY CONFORMANCE .....	37
EU COMPLIANCE STATEMENT .....	38
SPECTRUM AND POWER TABLE .....	38
CAT S52 SPECIFICATION .....	39
DECLARATION OF CONFORMITY .....	40

## WELCOME TO THE CAT® S52

The Cat® S52 is the unique blend of our thinnest and sleekest ever design whilst still being tough. Pocket friendly at just 9.69mm thin and 210g light, expose it to all weathers and conditions or just slip it in your pocket and forget about it.

The Cat® S52's camera is best-in-class. With fast and accurate focusing thanks to its dual pixel Sony sensor, and its bright f/1.8 aperture and large 1.4µm pixel size that delivers great low-light performance. (copy bank line 14) Packing a fast charging, 3100mAh battery, enough to take you through even the most action packed of days and beyond from a single charge.

Designed to be used just as it is, with no need to add a case. Offering a superior level of rugged protection that cannot be matched by a mainstream device in a case, it's the phone that life won't break. Use it with confidence without the stress or fear of breakage from everyday drops and mishaps.

## RUGGED CREDENTIALS

### DROPPING YOUR DEVICE:

- Do: Use your device up to a height of 1.5 metres – it's drop proof within this height range.
- Don't: Throw it with force, or drop from above the 1.5 metre range – it's durable, but not indestructible.

### WATERPROOFING:

- Do: Use your device in damp and wet conditions. Ensure all components and covers are properly closed before using in water. The device can withstand a depth of 1.5 metres, for up to 35 minutes.
- Don't: Attempt to use it for longer than 35 minutes in 1.5 metres depth or beyond a 1.5 metre depth.

### DUSTPROOF AND SCRATCHPROOF:

- Do: Use your device in dirty, dusty environments. The Cat® S52 is certified IP68, an industry standard measure for durability.

### EXTREME TEMPERATURES:

- Do: Use your device within the operational temperature range of -25° C to + 55° C. It can also handle extreme changes in temperature: shifting between cold and hot, or vice versa very quickly.
- Don't: Use it outside the range of 0° C to + 45° C without the use of protective gloves.

## WHAT'S IN THE BOX

- Device
- Quick start guide
- Warranty
- USB power cable and charging power adapter
- Factory-fitted screen protector (already on device)

### Note:

Your device comes with a factory-fitted screen protector. Please ensure that the screen protector remains in place. Removal of the screen protector may mean that any subsequent damage requiring repairs will be considered to be 'Out of Warranty'.

Please visit <https://www.catphones.com/screen-protectors> should you require a replacement screen protector.

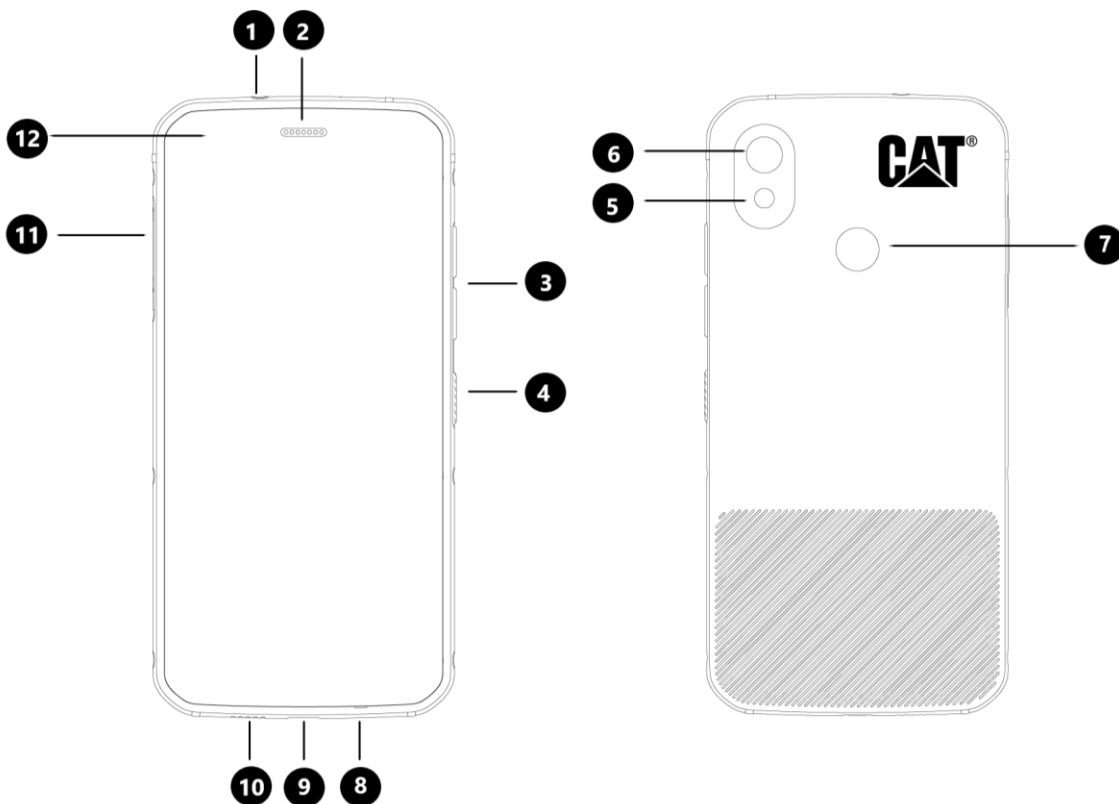

1. Headset Jack
2. Earpiece
3. Volume Up/Down Keys
4. Power button
5. Flash
6. Rear Camera

7. Fingerprint Scanner
8. Microphone
9. USB Port
10. Speaker
11. SIM/SD door
12. Front Camera

## KEY FUNCTIONS

### VOLUME UP/DOWN KEY

- Volume – press the Volume Up key to increase, or the Volume Down key to decrease the volume of the call, ringtone, media or alarm



- Screenshot – press Power and Volume Down keys simultaneously (Screenshots are saved in the photo album)
- Camera app – press Volume Up or Down key to take photo.

## GETTING STARTED

### INSTALLING SIM CARD(S) AND MEMORY CARD

1. Place your device on a flat, clean surface with the display facing upwards.
2. Use your fingertip to pull out the SIM/SD door and the SIM/SD tray.
3. Place the SIM card in the SIM 1/ SIM 2 tray with gold pins of the SIM card (facing down).
4. If you would like to use a microSD card, place this on the microSD tray with gold pins of the memory card also facing down.
5. Carefully insert the tray back into the SIM card slot and reposition the door.

#### NOTE

- Push the SIM/SD door back in until it is fixed securely.

Some devices take two SIM cards.

When two SIM cards are inserted, both SIM card slots can support 4G/3G service.

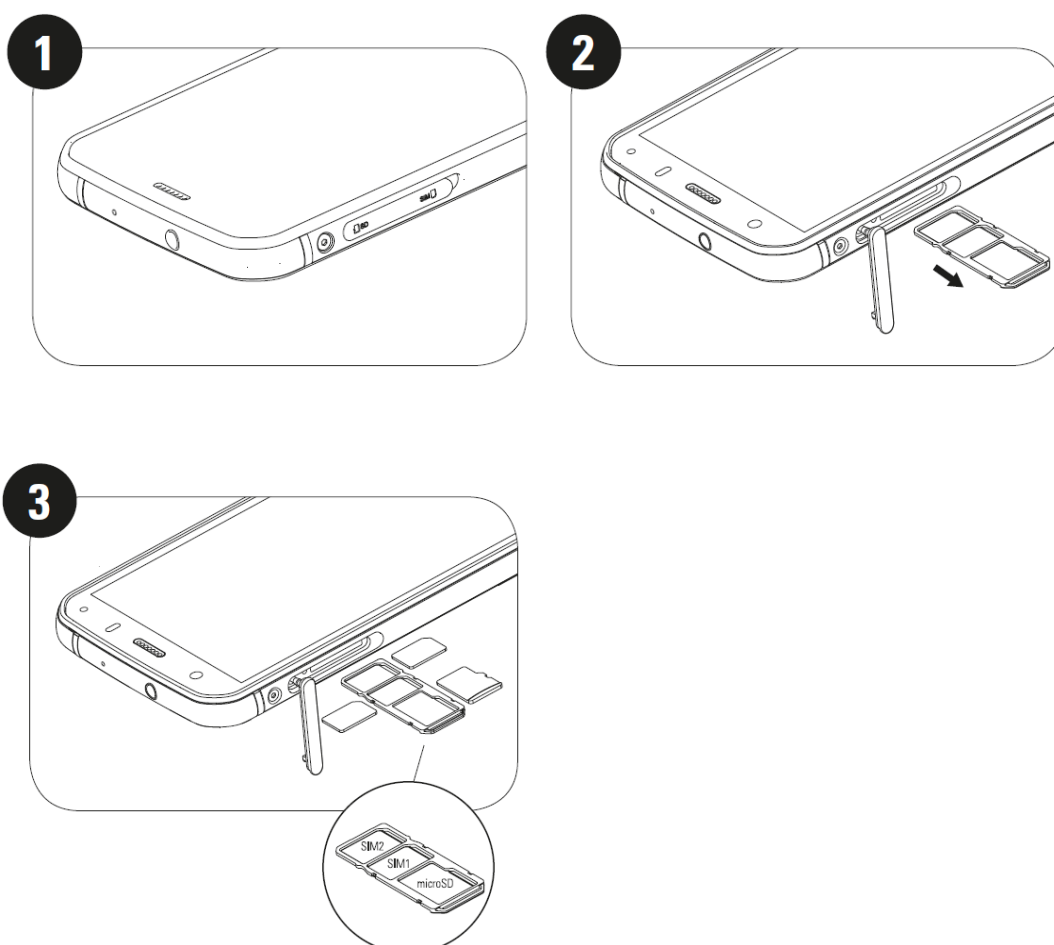

## CHARGING THE BATTERY

The S52 battery cannot be removed from the device. To charge it:

### 1. Connect the USB power cable to the charging power adapter.

Only use Cat® phone approved chargers and cables. Unapproved equipment may cause damage to the device or the battery and it will void the warranty.

### 2. Battery indicator changes from red to green when charging is completed.

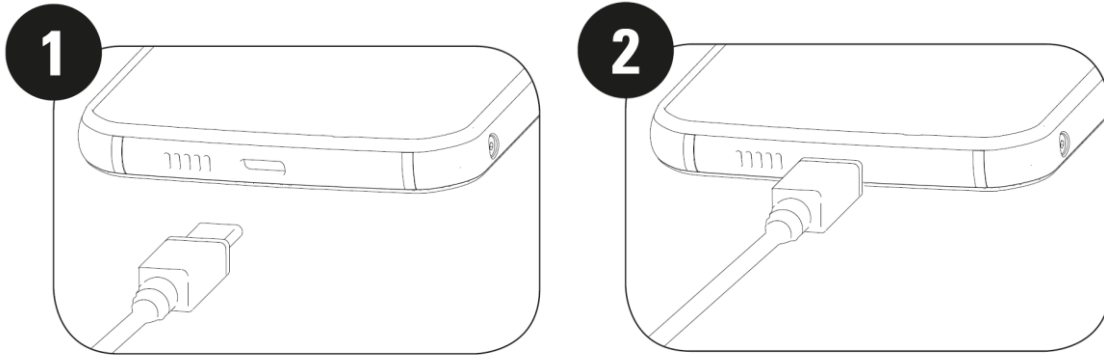

## IMPORTANT INFORMATION REGARDING FUTURE USE OF THE BATTERY

When the battery power level is low, the device displays a prompt. When the battery power is almost exhausted, your device will power off automatically. The time required to charge the battery depends on its age and the environmental temperature.

If the battery is completely exhausted, your device may not power on immediately after charging starts. Allow the battery to charge for a few minutes before attempting to turn it on. The on-screen charge animation may not be displayed during this period.

## POWERING YOUR DEVICE ON/OFF

### POWER ON

- Press and hold the Power Key to turn on your phone.

The first time you turn on your phone, you will see a Welcome Screen. Select your preferred language and tap START to continue the set-up.

- Press and hold to open the power off options (Power off/ Restart/ Screenshot) when the device is on.
- Press to lock or wake the screen when the device is idle.
- Press twice to open the Camera app when the device is locked.

### NOTE:

- A Wi-Fi or Data connection is required to access data and services.
- If personal identification number (PIN) protection is enabled on your SIM Card, you will be asked to enter your PIN before the Welcome Screen.

- A Google™ account is required to use some of the Google services on your device. You will be asked to sign in with your existing Google account, or set up a new account later.
- You may also record one or several of your fingerprints using the fingerprint scanner on the rear of the device. This provides a secure way to unlock your device. You must also define a PIN code or pattern as a secondary method for unlocking your device.

## POWER OFF

1. Press and hold the Power Key to open the Power Off options menu.
2. Tap Power off.

## TOUCHSCREEN

### TOUCHSCREEN ACTIONS

- **Tap:** Use your finger to select an item, confirm a selection or start an app on the screen.
- **Tap and hold:** Tap an item with your finger and continue to press until the screen responds (e.g. to open the options menu for the active screen, tap the screen and hold until the menu appears).
- **Swipe:** Move your finger across the screen either vertically or horizontally (e.g. swipe left or right to switch between pictures).
- **Drag:** To move an item, tap and hold it with your fingertip then drag it to any part of the screen.

## HOME SCREEN

The Home Screen is the starting point for accessing your device's features. It displays app icons, widgets, shortcuts and more.

You can customise your Home Screen with different wallpapers and adjust it to display your preferred items.

## LOCKING AND UNLOCKING THE SCREEN

### LOCKING THE SCREEN

1. If your device is turned on, press the **Power** Key to lock the screen. You can still receive messages and calls if the screen is locked.
2. If the device is left undisturbed for a certain period, the screen will lock automatically. You can adjust the length of this in the setting menu.

### UNLOCKING THE PHONE

- Use the fingerprint sensor to unlock. You will be prompted to configure this during the set-up wizard. If you want to add more fingerprints go to Settings – Security & Location – Fingerprint
- Press the **Power** key to wake up the screen. Then drag the unlock icon  upwards to unlock the screen. Enter pattern or PIN code if pre-set.

### NOTE:

When enrolling your fingerprints please make sure that you press your finger hard against the sensor. Failure to do so may see inconsistent results when using the fingerprint sensor.

## DISPLAY

### DISPLAY LAYOUT

#### NOTIFICATIONS AND STATUS INFORMATION

The Status Bar appears at the top of every screen. This displays notification icons, such as missed calls or received messages (on the left) and phone status icons, such as battery status (on the right), along with the current time.

#### STATUS ICONS



#### NOTIFICATIONS ICONS

<b>4G</b>	Connected to 4G mobile network		Cellular signal
<b>LTE</b>	Connected to LTE mobile network		Vibrate mode
<b>3G</b>	Connected to 3G mobile network		Location service is being used
<b>G</b>	Connected to GPRS mobile network		Battery is full
<b>E</b>	Connected to EDGE mobile network		Battery is charging
<b>H</b>	Connected to HSDPA mobile network		FM radio is turned on
<b>H+</b>	Connected to HSPA+ mobile network		Airplane mode
<b>R</b>	Roaming		Connected to a Wi-Fi network
	VoLTE		Upcoming event
	VoWiFi		Connected to a Bluetooth device
	Mobile network signal strength		Missed call
	NFC enabled		Speakerphone is activated
	New email message		Phone microphone is muted
	Alarm is set		Downloading data
	Data is syncing		New text message
	Problem with sign-in or sync		A Screenshot is captured



## NAVIGATION BAR

The navigation bar is located at the bottom of the screen. While the device is in full screen mode, please swipe up from the bottom of the device to make the navigation bar appears.

- If you would like to access recently used apps, please swipe up from the bar.



The bar contains two main soft buttons:

 Back Button	<ul style="list-style-type: none"><li>• Tap to return to the previous screen.</li></ul>
 Home Button	<ul style="list-style-type: none"><li>• Tap to return to the home screen</li><li>• Tap and hold to activate Google assistant</li></ul>

## NOTIFICATION PANEL

You will get a notification when you receive a new message, miss a call, or have an upcoming event. Open the notification panel to see alarms, wireless network operators or to view a message, reminder or event notification.

### OPENING THE NOTIFICATION PANEL

1. When a new icon appears, swipe down the notification panel and then drag down to open the notification panel.
2. Tap a notification to open the related app.

### CLOSING THE NOTIFICATION PANEL

1. To close the notification panel, slide the bottom of the panel upwards.
2. To close a notification (without viewing), hold the notification and drag it to the left/right of the screen.

#### NOTE:

- Notifications preferences can be changed in **Settings > Apps & notifications**.

## SHORTCUT ICONS

### ADDING A NEW HOME SCREEN ITEM

1. From the Home Screen, swipe  up twice.
2. To add an item to your Home Screen, drag its icon to your chosen position.

### MOVING A HOME SCREEN ITEM

1. Tap and hold an app icon on the Home Screen until it moves.
2. Without lifting your finger, drag the icon to the chosen position on the screen, then release it.

#### NOTE:

- There must be enough space for an icon to fit on the Home Screen panel.

## REMOVING A HOME SCREEN ITEM

1. Tap and hold an app icon on the Home Screen until it moves.
2. Without lifting your finger, drag the icon to Remove, then release.

## WIDGETS

A widget lets you preview, or use an app. You can place widgets on your Home Screen as icons or preview windows. Several widgets are already installed on your phone, while more can be downloaded from **Google Play**.

### ADDING A WIDGET

1. Tap and hold the Home Screen.
2. Tap the Widgets option to see what is available.
3. Drag your chosen widget to the Home Screen.

### REMOVING A WIDGET

1. Tap and hold the widget icon on the Home Screen until it moves.
2. Without lifting your finger, drag the icon to **Remove** at the top of the screen, then release.

## FOLDERS

### CREATING A FOLDER

You can group certain apps on your Home Screen by dragging an icon or shortcut and releasing it on top of another. This will create a new folder that you can add to as you choose.

### RENAMING A FOLDER

1. Tap a folder to open it.
2. Enter a new folder name in the title bar.
3. Then touch the screen anywhere outside of the folder.

## WALLPAPERS

### CHANGING YOUR WALLPAPER

1. Tap and hold the Home Screen.
  1. Tap **Wallpapers**.
  2. Scroll through the available options.
  3. Tap **Set Wallpaper** on chosen image – then choose whether to set it as **Lock Screen wallpaper**, **Home Screen** wallpaper or both.

## TRANSFERRING MEDIA TO AND FROM YOUR DEVICE

Transfer your favourite music and pictures between your device and PC in Media Device MTP mode.

1. Connect your device to your PC with the USB power cable.
2. Open the notification panel and the USB connection options. Tap **Charging this device via USB** to access more options.
3. Tap **File transfer** to share files to/from your PC.
4. Your device should be displayed as a removable device displaying the phone's internal storage. If a memory card is inserted, microSD card will also be visible. Copy the chosen files to your device.

Your device will be displayed as a removable device, showing the phone's internal storage. If a memory card is inserted, the microSD card details will also be visible.

### NOTE:

- If you are using a MAC, the drivers must be downloaded from: <http://www.android.com/filetransfer/>

## USING FLIGHT MODE

Some locations may require you to switch off data connections. Instead of turning off your device, you can set it to Flight Mode.

1. From the **Home Screen**, swipe down the notification panel and tap  to switch on Flight mode.

### NOTE:

- You can also access Flight Mode from the **Setting** menu.

## MAKING A PHONE CALL



There are multiple ways to place a call. You can either:

1. Dial a number into the keypad.
2. Select a number from your contacts list.
3. Select a number from a web page or document that contains a phone number.

### NOTE:

- When you're on a call, you can either answer incoming calls or send them to your voicemail. You can also set up conference calls with several participants.
- When you're on a call, press the Home button to return to the Home Screen and use other functions. To return to the calling screen, drag the notification bar down and tap **Current call**.



### MAKING A PHONE CALL WITH THE KEYPAD

1. From the **Home Screen**, tap . Then tap  to show the keypad.
2. Tap the numeric keys to dial the phone number.



3. After you enter the number, or select the contact, tap .

Tip: Your device supports the **SmartDial** function. As you type a number into the keypad, it automatically searches your contacts and lists options for ones that match the number. You can close the keypad to view more possible matches.

## MAKING A PHONE CALL FROM CONTACTS

1. From the Home Screen, swipe  up twice > **Contacts** to display the contact list. From the keypad, tap the  tab to see the contact list.
2. Select a contact.
3. Tap the phone number to call the contact.

## MAKING A PHONE CALL FROM THE CALL LOG

1. Swipe  up twice > **Phone**  tab to see a list of latest calls. If you cannot find the desired contact, tap  > **Call history** to display all call history.
2. Select a contact from the list and tap to make a call.

## ANSWERING AND REJECTING A PHONE CALL

When you receive a phone call, the incoming call screen will show the caller ID, and any additional caller information that you have entered in Contacts.

- To answer a call, tap **ANSWER**.
- To reject the call, tap **DECLINE**.
- To reject the call and send a message directly to the caller, tap the call notification banner and then tap . Select one of the available template message options or tap Write your own to compose a personal message.

## ENDING A PHONE CALL

During a phone call, press **Hang up**  to hang up.

# CONTACTS

The Contacts app lets you save and manage information about your contacts.

## OPENING THE CONTACTS APP

When you set up the device, **Contacts** will display a message outlining how to start adding contacts. To open the app, do one of the following:

- From the **Home Screen**, swipe  up twice and then **Contacts** .



- All of your contacts are displayed alphabetically in a scrolling list. Tap on them to see more details.

## COPYING CONTACTS

You can copy your contacts from the SIM card or saved in internal storage or a memory card.

1. In the contacts list, tap  > **Settings** > **Import**.

2. Do one of the following:

- To import contacts from the SIM card:

Tap **SIM card**. Select the contact(s) and tap **IMPORT** to import the selected contact(s).

- To import contacts from the internal storage or memory card:

Tap **.vcf file**. Select the location where to import the contacts and tap the \*.vcf file to import the contacts.

## BACK UP CONTACTS

You can copy contacts to internal storage.

1. In the contacts list, tap  > **Settings** > **Export**.

2. Select the location where to save the contacts and tap **SAVE**.

## ADD A NEW CONTACT

1. In the contacts list, tap  to add a new contact.

2. Enter the contact's name, and then add any detailed information such as phone number or address.

3. Tap **Save** to store the contact information.

## ADDING A NEW CONTACT TO YOUR FAVOURITES

1. Tap the contact you want to add to Favourites.

2. Tap  at the top right corner.

## SEARCHING FOR A CONTACT

1. In the contacts list, tap **Search contacts** to search for a contact.

2. Enter the name of the contact for which you are searching. As you type, contacts with matching names appear below the search box.

## EDITING A CONTACT

You can always make changes to the information you have stored for a contact.

1. In the contacts list, tap the contact you want to edit.

2. Tap **Edit contact**.
3. Make the desired changes to the contact information, then tap **Save**. To cancel any changes press **X**.

## DELETING A CONTACT

1. In the contacts list, tap the contact you want to delete.
2. Tap  > Delete.
3. Tap Delete again to confirm.

## USING THE ON-SCREEN KEYBOARD



### DISPLAYING THE KEYBOARD PANEL

Some apps open the keyboard automatically. In others, tap a text field to open the keyboard. Press the Back button to hide the keyboard.

### USING THE LANDSCAPE KEYBOARD

If you find it difficult to use the keyboard in portrait orientation, simply turn the device sideways. The screen will now display the keyboard in landscape orientation, providing you with a wider keyboard layout.



### CUSTOMISING YOUR KEYBOARD SETTINGS

1. From the **Home Screen**, swipe  up twice > **Settings**  > **System** > **Languages & input**.
2. Do any of the following:
  - Tap Virtual keyboard to configure the Google keyboard and Google voice typing settings.
  - Tap Physical keyboard to configure the external keyboard settings.
  - Tap Advanced to access the input assistance related settings.

## WI-FI®

Access to wireless access points (hotspots) is required to use Wi-Fi on your device.

### TURNING ON WI-FI AND CONNECTING TO A WIRELESS NETWORK

1. Swipe  up twice from the **Home Screen** > **Settings**  > **Network & Internet**.
2. Tap **Wi-Fi** and slide the Wi-Fi switch to the right .
3. Choose a Wi-Fi network to connect to from the list.
4. If you select an open network, the device will connect automatically. If you select a network that is secured, you must enter a password and tap **Connect**.

#### NOTE:

- You will not have to re-enter the password for a secured network if you have connected to it before, unless the device has been reset to its default settings, or if the Wi-Fi password has been changed.



- Obstacles blocking the Wi-Fi signal will reduce its strength.

Tip: On the Wi-Fi settings screen, tap **+ Add network** to add an invisible Wi-Fi network.

## SMS AND MMS

### OPENING MESSAGING

To open the app, do one of the following:

- Tap  on the **Home Screen**.
- Swipe  up twice from the **Home Screen > Messages** .

### CREATING AND SENDING A TEXT MESSAGE



You can create a new text message or open an ongoing message thread.

1. Tap **Start Chat** to start a new text message or tap an existing message thread to open it.
2. Enter a phone number or contact name into the To field. When you type, the **SmartDial** will attempt to match it with the device's contacts. Either tap a suggested recipient or continue to type. If you want to open an existing message thread, simply tap it.
3. Tap the text box to compose your message. If you press the **← Back** button while composing a message, it will save as a draft in the message list. Tap the message to resume.
4. When your message is ready to send, tap .

#### NOTE:

- As you view and send additional messages, a message thread is created.

### CREATING AND SENDING A MULTIMEDIA MESSAGE

1. On the messaging screen, tap **Start Chat**.
2. Enter a phone number or contact name into the To field, or scroll down the contact list to find the contact you wish to message. Tap to start a group conversation.
3. Tap the text box to compose a message.
4. Tap  again and select the type of media file. Select the file to attach.
5. Your device is now in multimedia mode. Once you're done, tap .

### OPENING AND REPLYING TO A MESSAGE

1. In the message list, tap a text or multimedia message thread to open it.
2. Tap the text box to compose a message.
3. When ready, tap .

## CUSTOMISING THE MESSAGE SETTINGS

In the message list, tap  > **Settings** to customise your message settings. Choose from:



**Default SMS app:** Specify the default SMS app (**Messages** is default)

## BLUETOOTH®

Your Cat® S52 device has Bluetooth. It can create a wireless connection with other Bluetooth devices, so you can share files with your friends, talk hands-free with a Bluetooth headset, or even transfer photos from your device to a PC.

If you are using Bluetooth, remember to stay within 10 metres of the Bluetooth device you want to connect to. Be aware that obstacles like walls or other electronic equipment may interfere with the Bluetooth connection.

### TURNING ON BLUETOOTH

1. Swipe  up twice from **Home Screen** > **Settings** > **Connected devices**.
2. Tap **Connection preference** > **Bluetooth** and slide the switch  to the right to enable the function.

When Bluetooth is turned on, the Bluetooth icon  appears in the notification bar.

### PAIRING AND CONNECTING A BLUETOOTH DEVICE

Bluetooth lets you do the following:

- Use a hands-free Bluetooth device.
- Use a mono or stereo Bluetooth headset.
- Control what plays through the Bluetooth headset remotely.

Before you use Bluetooth, you need to pair your device with another Bluetooth device as follows:

1. Ensure that the Bluetooth function on your device is enabled.
2. Tap **+ Pair new device**. Your Ca®t S52 will then search for Bluetooth devices in range.
3. Tap the device you want to pair with.
4. Follow the on-screen instructions to complete the connection.

#### NOTE:



- Once a partnership has been created, you will no longer have to enter a password if you connect to that Bluetooth device again.

### SENDING FILES VIA BLUETOOTH

With Bluetooth, you can share pictures, videos, or music files with family and friends. To send files via Bluetooth:

1. Tap the file you want to send.
2. Tap  > **Bluetooth**, then select a paired device.

### DISCONNECTING OR UNPAIRING A BLUETOOTH DEVICE

1. Swipe  up twice from **Home Screen** > **Settings** > **Connected devices**.
2. Tap **Previously connected devices**.
3. Tap  and then tap **FORGET** to confirm the disconnection.

## TAKING PHOTOS AND RECORDING VIDEOS



You can use your Cat® S52 to shoot and share pictures and videos.

### OPENING YOUR CAMERA AND TAKING A PHOTO

To open the camera app, do the following:

- Tap  on the Home Screen.
- By default, the app opens in Camera mode. If not, tap **Photo** at bottom of the screen.

#### NOTE:

- Press the Back or Home button to close the camera.
- To switch between front and rear camera, tap .
- Compose your photo within the photo capture screen.
- Tap the screen to focus on a specific area.
- Pinch to zoom in/out of the subject.
- Tap  to change the camera settings; set a self-timer, adjust the anti-flicker or adjust the image properties.
- Tap  to take your photo.
- you can also take photos by pressing the **Volume up/down** keys.



### VIEWING PHOTOS

To view your photos, do one of the following:

- When in the **Camera** app, tap the thumbnail of the latest captured photo in the bottom right hand corner to access the gallery app.





#### NOTE:

- To go back to Camera view, press the Back button or swipe to the right until the capture screen appears again.







- Swipe  up twice from **Home Screen** > **Photos**  to view all photos and videos.

## EDIT AND SHARE PHOTOS

As you browse through your photos, the following options are available:

- Share: Tap  to share your photos through various apps available on your device.
- Edit: Tap  to edit your photos with a range of options available.
- Search: Tap  to search the photo on Google for related information.
- Delete: Tap  to delete the photos you don't want.

## SHOOTING A VIDEO

1. Tap  on the Home Screen.
  - By default, the app opens in Camera mode.
2. Swipe the left to switch to Video mode.
  - To switch between front and rear camera, tap .
3. Tap  to start recording.
4. While recording, do one of the following:
  - Pinch to zoom in/out on the subject.
  - Tap  to pause the recording. Tap again to resume.
  - Tap  to take a photo.
5. Tap  to stop shooting.



## VIEWING YOUR VIDEOS

To view a video after recording, tap the thumbnail of the latest captured video in the bottom right hand corner to access the gallery app.

## USING PHOTOS

The **Photos** app automatically searches for pictures and videos saved to your device or memory card. Select the album/folder and play as a slideshow, or select items to share with other apps.

## OPENING PHOTOS



Swipe  up twice from **Home Screen > Photos**  to open the application. The Photos app categorises your pictures and videos by storage location and stores these files in folders. Tap a folder to view the pictures or videos inside.

## VIEWING A PHOTO

1. In **Photos**, tap a folder to view the photos inside.
2. Tap the picture to view it in full-screen mode, then swipe left or right to view the previous or next picture.
3. To zoom in on the image, pinch two fingers apart from each other at the location of the screen where you want to zoom in. In zoom mode, swipe your finger up or down and left or right.

Tip: The picture viewer supports rotation function. Tap the  after you rotated the device, the picture will adjust itself to the rotation.

## CROPPING A PICTURE IN PHOTOS

1. When viewing a picture, tap .
2. Tap  and use the cropping tool to select the portion of the picture to crop.
  - Drag from the inside of the cropping tool to move it.
  - Drag an edge or a corner of the cropping tool to resize the image.
3. Tap **Done > Save copy** to save the cropped picture.
  - To discard the changes, press the **Back button** and tap **DISCARD**.



## ENJOYING MUSIC

Music files can be transferred from a PC onto your Cat® S52 so you can listen to music wherever you are.

### COPYING MUSIC TO YOUR DEVICE

1. Connect your device to a computer with the USB cable and select **File Transfer** on the device.
2. On the PC, navigate to the USB drive and open it.
3. Create a folder in the root directory of your device or in the SD card (for example, Music).
4. Copy your music from the PC to the new folder.
5. To safely remove your device from the PC, wait until the music has finished copying, then eject the drive as required by your PC's operating system. Disconnect the USB cable.

### OPENING GOOGLE PLAY MUSIC

- Tap the Google app on the Home Screen, then tap **Play Music** .
- Tap , then tap Music library. It contains five tabs: PLAYLISTS, ARTISTS, ALBUMS, SONGS, and GENRES.

## PLAYING MUSIC

1. Tap a category on the Music library screen.
2. Tap the song you want to play.





Tip: When listening to music, press the **Back** button to use another app and continue listening. To return to the music controls, open the notification panel and tap the song.

## LISTENING TO FM RADIO

You can listen to FM radio stations in the **FM Radio** app.

Firstly, connect the headset to the audio jack before opening the app. Then tap **> FM Radio**  to launch the app.

### CHOOSE FROM THE FOLLOWING OPTIONS:



- To manually tune a frequency, tap **<** or **>**.
- To scan the radio stations automatically, tap  **>** , and select your preferred topic from the list.
- To add the current radio station to your favourites list, tap .
- To turn off the radio, tap , and press the **Back button** to exit the app.

## USING GOOGLE SERVICES

You must sign in to a Google account to use Gmail, Google Calendar, and to download and use other Google apps.

### CREATING A GOOGLE ACCOUNT

If you chose not to create a Google account during set up, it's easy to create one:

1. Swipe  up twice from **Home Screen** **>** **Settings** .
2. Tap **Accounts** **>** **Add account**.
3. Tap **Google** , then follow the on-screen instructions.

### USING GMAIL

During set-up, you may have configured your device to an existing Gmail account. The first time you open the **Gmail** app on your phone, your Inbox will contain the messages from this account.

### OPENING GMAIL





Swipe  up from **Home Screen** > Gmail .



## SWITCHING BETWEEN ACCOUNTS

Tap the account selection box in the top right of the screen, then tap the account you want to view.

## CREATING AND SENDING AN EMAIL

1. On the Inbox screen, tap (  ).
2. Enter the message recipient's email address in the **To** field.
  - To send the email to several recipients, separate the email addresses with spaces.
  - To **Cc** or **Bcc** other recipients, tap **V** to display the **Cc/Bcc** fields.
3. Enter the email subject and compose your message.
  - If you want to add a picture attachment, tap  > **Attach file**, to select a file.
4. To send, tap .

## REPLYING OR FORWARDING EMAIL

1. Select the email on the Inbox screen.
2. Tap  to reply, or tap  to select **Reply all** or **Forward**.

## CUSTOMISING YOUR GMAIL SETTINGS

3. On the Gmail home screen, tap  > **Settings**.
4. Choose General settings, or an email account.
5. Tap an option and change the necessary settings.

## USING GOOGLE PLAY STORE

Download and install apps and games from the Play Store onto your device.

### OPENING GOOGLE PLAY STORE

Swipe  up twice from **Home Screen** > **Play Store** .



### SEARCHING FOR APPS

To find apps on the **Play Store** home screen, you can:

- List apps by category: Tap a category and scroll through.

- Use Search: Enter search keywords in the field.
- To view your installed apps, tap  > **My apps & games**.

## INSTALLING AN APP

1. Swipe  up twice from **Home Screen** > **Play Store** .
2. Tap a category, and then tap the item you want to download for added information.
3. To install the item, tap **Install**.

### NOTE:

You can check the progress of a download in the notification panel.

## UNINSTALLING AN APP

1. On the **Play Store** home screen, tap  > **My apps & games**.
2. Select tab **INSTALLED**.
3. Choose the app you want to uninstall and tap **Uninstall**.
4. Tap **OK** to remove the app from your device.

### NOTE:

Apps can also be managed by going to the main phone **Settings** > **Apps & notifications**. They can also be uninstalled directly from the **App drawer** by holding your finger on the app and dragging it up to **Uninstall**.

## SYNCHRONISING INFORMATION

Some apps (for example, Gmail and Calendar) on your Cat® S52 provide access to the same information that you can add, view and edit on other devices. If you add, change or delete information in any of these apps on other devices, the updated information will also appear on your device.

This is made possible through over-the-air data synchronisation. The process occurs in the background and does not interfere with your device. When your device is synchronising, a data synchronisation icon will be shown in the notification bar.

## MANAGING YOUR ACCOUNTS

You can synchronise contacts, email and other information on your device with multiple Google accounts or other accounts, depending on the apps you have installed.

For example, adding a personal Google account means your personal email, contacts, and calendar entries are always available. You can also add a work account, so your work-related emails, contacts and calendar entries are kept separate.

## ADDING AN ACCOUNT

1. Swipe  up twice from **Home Screen > Settings** .
2. Tap **Accounts**. The screen will show your current synchronisation settings and a list of your current accounts being used in related applications.

**NOTE:**

- In some cases, account details may need to be obtained from your network administrator support. For example, you may need to know the account's domain or server address.

3. Tap **+ Add account**.
4. Tap the account type to add.
5. Follow the on-screen instructions to enter the required and optional information about your account. Most accounts require a username and password, but the details depend on the kind of account and the configuration of the service to which you are connecting to.
6. When you are finished, your account will be added to the list in the **Accounts** settings screen.

## REMOVING AN ACCOUNT

An account and all information associated with it can be removed from your device, including email, contacts, settings, etc. Some accounts, however, cannot be removed, such as the first account you signed into on your device. If you attempt to remove certain accounts, be aware that all personal information associated with it will be deleted.



1. On the **Accounts** settings screen, tap the account to delete.
2. Tap **REMOVE ACCOUNT**, then again when prompted to confirm.

## CUSTOMISING YOUR ACCOUNT SYNCHRONISATION

Background data use and synchronisation options can be configured for all the applications on your device. You can also configure the kind of data synchronised for each account. Some applications, such as Contacts and Gmail, can synchronise data from multiple applications.

Synchronising is two-directional for some accounts and changes made to the information on your device are made to the copy of that information on the web. Some accounts support only one-way synchronisation and the information on your device is read-only.

## CHANGING AN ACCOUNT'S SYNCHRONISATION SETTINGS



1. On the **Accounts** settings screen, tap the account.
2. Tap **Account sync**. The data and synchronisation screen will open, displaying a list of information that the account can synchronise.
3. Enable the items you want to sync by:
  - Sliding the respective data switch to the right  .
  - To disable automatic sync, slide the respective data switch to the left  .

## USING OTHER APPS



### USING THE CALENDAR

Use **Calendar** to create and manage events, meetings and appointments. Depending on your synchronisation settings, the calendar on the device stays in synchronisation with the calendar on your other devices.

### OPENING THE CALENDAR

Swipe  up twice from **Home Screen** > **Calendar**  to open the app. Tap to display the various view and settings options.

### CREATING AN EVENT

1. On any calendar view, tap  > **Event**, to start adding an event.
2. Enter the event title, location, or the contacts.
  - If there is a time frame for the event, tap the beginning and end date, and times.
  - If it is a special occasion such as a birthday or a day-long event, slide the All-day switch to the right .
3. Set the time of your event reminder, invite people, set a colour and add any notes or attachments.
4. Once all information is entered and settings are complete, tap **Save**.



### SETTING AN EVENT REMINDER

1. On any calendar view, tap an event to view its details.
2. Tap  to start editing the event.
3. Tap **Add notification** to set the reminder for the event.
4. Tap **Save** to save it.

### USING THE ALARM

You can set a new alarm or modify an existing alarm.

### OPENING THE ALARM

Swipe  up twice from **Home Screen** > **Clock**  > to use your device alarm.

### ADDING AN ALARM

1. On the alarm list screen, tap  to add an alarm.
2. To set your alarm, do the following:

- Set the hour and minutes by navigating around the dial, tap **OK**.
- To set repeat mode, tap the **Repeat** check box. Tap one or more options.
- To set the ringtone, tap , then select an option.
- If you want your device to vibrate when the alarm sounds, tap the **Vibrate** check box.
- To add an alarm label, tap **Label**. Enter the label, then tap **OK**.



**NOTE:**

- By default, the alarm is automatically activated.

## CALCULATOR

Your Cat® S52 is equipped with a calculator that has both a standard and advanced mode.

### OPENING THE CALCULATOR

1. Swipe  up twice from **Home Screen** > Calculator  to open the app.
2. Swipe left or rotate the device to horizontal to access the Advanced calculator mode.

## MANAGING THE DEVICE

To configure your device, swipe  up twice from **Home Screen** > **Settings** .

### SETTING THE DATE AND TIME

When you first turn on your device, there is an option to update the time and date automatically, using the time provided by your network.

**NOTE:**

You cannot set the date, time and time zone manually if using the automatic option.

If you wish to set the date and time settings manually, do the following:

1. On the Settings screen, tap **System** > **Date & time**.
2. Tap **Automatic date & time** and select **Off**. Slide the Automatic time zone switches to the left  to disable the functions.
3. Tap **Set date**, then select the desired date and tap **OK**.
4. Tap **Set time**. On the set time screen, tap the hour or minute field and move the pointer up or down to set the time. Tap **OK** when the configuration is complete.
5. Tap **Select time zone**, and then select the desired time zone from the list.
6. Enable or disable the Use 24-hour format function to switch between 24-hour and 12-hour formats.

## PERSONALISING THE DISPLAY

### ADJUSTING THE SCREEN BRIGHTNESS

1. On the **Settings** screen, tap **Display > Brightness level**.
2. Drag the slider left to make the screen darker, or right to make it brighter.
3. Lift your finger off the slider to save your settings automatically.

Tip: Slide the Adaptive Brightness switch to the right to enable the device to automatically adjust the brightness of the screen depending on the light level around you.

### AUTO-ROTATE SCREEN

To enable the display to rotate when you turn your device between landscape and portrait, tap **Advanced** and slide the Auto-rotate switch to the right  .

### ADJUSTING THE IDLE TIME BEFORE THE SCREEN TURNS OFF

If your device is idle for a period of time, the screen will turn off to save battery power. To set a longer or shorter idle time:



1. On the **Settings** screen, tap **Display > Advanced > Sleep**.
2. Select the duration you want the screen to be illuminated for before it turns off.

#### NOTE:

When your device is asleep, use the fingerprint sensor or press **Power** to wake the screen.

## SETTING YOUR RINGTONE

### TURNING ON SILENT MODE

- Press the Volume down key until  appears on the screen. Then tap the first icon to select  .
- All sounds except media and alarms will be silenced.

### ADJUSTING THE RINGTONE VOLUME

You can adjust the ringtone volume from the **Home Screen**, or from any app (except during a call or when playing music or videos). Press the **Volume up/down key** to adjust the ringtone volume to your chosen level. You can also adjust the ringtone volume on the **Settings** screen.

1. On the **Settings** screen, tap **Sound**.
2. In **Ring volume**, drag the slider to adjust the volume level.

### CHANGING THE RINGTONE

1. On the **Settings** screen, tap **Sound**.
2. Tap **Phone ringtone**.

3. Select the ringtone you want to use. A preview plays when selected.

4. Tap **OK**.

## SETTING THE DEVICE TO VIBRATE FOR INCOMING CALLS

On the **Settings** screen, tap **Sound > Advance**. Then slide the **Also vibrate for calls** switch to the right .

## SETTING PHONE SERVICES

### TURNING ON DATA ROAMING

1. On the **Settings** screen, tap **Network & Internet > Mobile network**.

2. Slide the Roaming switch to the right .

NOTE:

- Remember that accessing data services while roaming may incur considerable additional charges. Check with your network service provider about data roaming fees.

### DISABLE DATA SERVICE

1. On the **Settings** screen, tap **Network & Internet > Mobile network**.

2. Slide the Mobile data switch to the left .

## USING NFC

NFC allows the exchange of data between two NFC-enabled devices, when both devices are either touching or no more than a few centimetres apart.

### ACTIVATING THE NFC FUNCTION

1. On the **Settings** screen, tap **Connected devices**.

2. Slide the NFC switch to the right .

3. The Android™ Beam function will also be enabled automatically.

### BEAMING CONTENT VIA NFC

1. Enable the NFC and Android Beam functions.

2. Open the content to be shared (you can share web content, YouTube videos, contacts and much more)

3. Place the devices back-to-back, when prompted Tap to beam, tap your screen.

## PROTECTING THE DEVICE

### ENABLE YOUR SIM CARD PIN

1. On the **Settings** screen, tap **Security & location > Advanced >SIM card lock**.
2. Slide the Lock SIM card switch to the right.
3. Enter the SIM card PIN, then tap **OK**. To change the SIM card PIN at any time, tap Change SIM PIN.

**NOTE:**

You can dial emergency numbers any time from your device.

## **PROTECTING THE DEVICE WITH A SCREEN LOCK**

To keep the data on your Cat® S52 more secure you can use a screen lock method.

1. On the **Settings** screen, tap **Security & location > Screen lock**.
2. Select the one of the available options.
  - **Swipe:** Swipe the lock icon up to unlock the screen.
  - **Pattern:** Trace the correct unlock pattern to unlock the screen.
  - **PIN:** Enter a PIN number to unlock the screen.
  - **Password:** Enter a password to unlock the screen.
  - **Fingerprint:** Put your fingertip on the fingerprint scanner to unlock the screen
3. Follow the on-screen instructions to complete the set-up of your chosen screen lock method.

**NOTE**

When adding your fingerprint, it is important to place your fingerprint against the sensor firmly. You will also need to enrol all of your fingerprint, the center, left and right side as well as the top of your fingertip. This will ensure that the sensor works accurately.

The fingerprint that you store can also be used to access some apps that requires additional security. If this is available, the app will notify you of this when you next log in.

## **MANAGING APPS**

### **VIEWING AN INSTALLED APP**

1. On the **Settings** screen, tap **Apps & notifications**.
2. In the apps list, do any of the following:
  - Tap an app to view its details directly.
  - Tap **Notifications** to configure the notification settings.
  - Tap **Advanced > App permissions** to adjust what information the app can access.
  - Tap **Advanced > Default apps** to set, or clear default apps.
  - Tap **Advanced > Emergency alerts** to change your emergency alert settings.
  - Tap **Advanced > Special app access** to configure which apps can access special features listed here.



## RESETTING THE DEVICE

### BACKING UP PERSONAL SETTINGS

Your personal settings can be backed up to Google servers with a Google account. If you replace your device, the backed-up settings will be transferred onto a new device the first time it is signed into from a Google account.

1. On the **Settings** screen, tap **System > Backup**.
2. Slide the **Back up to Google Drive** switch to the right .

### RESTORING FACTORY DATA

If you restore the factory data, your device will reset to the settings that were configured at the factory. All of your personal data from the internal device storage, including account information, the system and application settings, and any downloaded applications will be erased.

Resetting your device does not erase any system software updates that have been downloaded or any files on a microSD card, such as music or photos.

1. On the **Settings** screen, tap **System > Advanced > Reset options > Erase all data (factory reset)**.
2. When prompted, tap **RESET PHONE**, and then tap **ERASE EVERYTHING**. The device will reset to the original factory settings, and then restart.

# APPENDIX

## OPERATING TEMPERATURE

- Keep the ambient temperature between 0°C and 40°C while the device is being charged. Keep the ambient temperature between -25°C to 55°C for using the device powered by a battery. Please wear protective gloves while using it outside the range of 0°C to + 45°C.

## CHARGER OUTPUT

- Output rating of charger 5V/2.0A, 9V/1.7A

## VIEWING THE E-LABEL

To view the regulatory information on your device, do the following:

1. From the Home Screen, tap > Settings.
2. On the Settings screen, tap About phone > Regulatory information.

## PREVENTION OF HEARING LOSS



To prevent possible hearing damage, do not listen at high volume levels for long periods.

## HEARING AID COMPATIBILITY (HAC)

### REGULATIONS FOR WIRELESS DEVICES US VARIANT ONLY

#### WHAT IS HEARING AID COMPATIBILITY?

The Federal Communications Commission has implemented rules and a rating system designed to enable people who wear hearing aids to more effectively use these wireless telecommunications devices. The standard for compatibility of digital wireless phones with hearing aids is set forth in American National Standard Institute (ANSI) standard C63.19. There are two sets of ANSI standards with ratings from one to four (four being the best rating): an “M” rating for reduced interference making it easier to hear conversations on the phone when using the hearing aid microphone, and a “T” rating that enables the phone to be used with hearing aids operating in the telecoil mode thus reducing unwanted background noise.

This device has been tested and rated for use with hearing aids, with some of the wireless technologies that it uses. However, there may be newer wireless technologies used in the device that have not been tested yet for use with hearing aids. It is important to try the different features on your device thoroughly and in different locations whilst using a hearing aid or cochlear implant to determine if there is any interfering noise. Consult your service provider or the device manufacturer for information on hearing aid compatibility. If you have any questions about return or exchange policies, consult your service provider or phone retailer.

- The U.S. Federal Communications Commission (FCC) has established requirements for digital wireless mobile devices to be compatible with hearing aids and other hearing assistive devices.
- The wireless telephone industry has developed a rating system to assist hearing device users, reviewing the compatibility of mobile devices with hearing devices.
- The ratings are not guaranteed. Results will vary depending on the user’s hearing device and hearing loss. If a user’s hearing devices happens to be vulnerable to interference, the user may not be able to use a rated phone device successfully. Testing the mobile device with a hearing device is the best way to evaluate if it is suitable for a user’s personal needs.

- The FCC has adopted HAC rules for digital wireless phones. These rules require certain devices to be tested and rated under the American National Standard Institute (ANSI) C63.19-2011 hearing aid compatibility standards. The ANSI standard for hearing aid compatibility contains two types of ratings:
- M-Ratings: Phones rated M3 or M4 meet FCC requirements and are likely to generate less interference to hearing devices than mobile devices that are not labelled. M4 is the better/higher of the two ratings.
- T-Ratings: Phones rated T3 or T4 meet FCC requirements and are likely to work better with a hearing device's telecoil ("T Switch" or "Telephone Switch") than unrated phones. T4 is the better/ higher of the two ratings. (Note not all hearing devices have telecoils in them.) The tested M-Rating and T-Rating for this device (FCC ID: ZL5S52E), M3 and T4.

## EMERGENCY CALL

This device can be used for emergency calls in the service area. The connection, however, cannot be guaranteed in all conditions. The device should not be relied on solely for essential communications.

## CE SAR COMPLIANCE

This device meets the EU requirements (1999/519/EC) on the limitation of exposure of the general public to electromagnetic fields by way of health protection.

The limits are part of extensive recommendations for the protection of the general public. These recommendations have been developed and checked by independent scientific organizations through regular and thorough evaluations of scientific studies. The unit of measurement for the European Council's recommended limit for mobile devices is the "Specific Absorption Rate" (SAR), and the SAR limit is 2.0 W/ kg averaged over 10 gram of tissue. It meets the requirements of the International Commission on Non-Ionizing Radiation Protection (ICNIRP).

For body worn operation, this device has been tested and meets the ICNIRP exposure guidelines and the European Standard EN 62209-2, for use with dedicated accessories. Use of other accessories which contain metals may not ensure compliance with ICNIRP exposure guidelines.

SAR is measured with the device at a separation of 5 mm to the body, while transmitting at the highest certified output power level in all of the device's frequency bands.

The highest reported SAR values under the CE regulatory for the phone are listed below:

Head SAR: 1.07W/kg, Body SAR: 1.32W/kg

To reduce exposure to RF energy, use a hands-free accessory or other, similar options to keep this device away from your head and body. The device must be carried 5mm from the body to ensure exposure levels remain at or below the as-tested levels. Choose the belt clips, holsters, or other similar body-worn accessories which do not contain metallic components to support operation in this manner. Cases with metal parts may change the RF performance of the device, including its compliance with RF exposure guidelines in a manner that has not been tested or certified. Thus, use of such accessories should be avoided.

### **To reduce the level of exposure to radiation, please do the following:**

- Use the mobile phone in good reception conditions to reduce the amount of radiation received (in particular in underground car parks and on train or car journeys).
- Use a hand free kit
- For pregnant women, please keep the device away from the stomach
- Use the device away from genital parts

## **FCC REGULATION**

This mobile phone complies with part 15 of the FCC Rules. Operation is subject to the following two conditions:

- (1) This device may not cause harmful interference, and (2) this device must accept any interference received, including interference that may cause undesired operation.

This mobile phone has been tested and found to comply with the limits for a Class B digital device, pursuant to Part 15 of the FCC Rules. These limits are designed to provide reasonable protection against harmful interference in a residential installation. This equipment generates, uses and can radiate radio frequency energy and, if not installed and used in accordance with the instructions, may cause harmful interference to radio communications.

However, there is no guarantee that interference will not occur in a particular installation. If this equipment does cause harmful interference to radio or television reception, which can be determined by turning the equipment off and on, the user is encouraged to try to correct the interference by one or more of the following measures:

- Reorient or relocate the receiving antenna.
- Increase the separation between the equipment and receiver.
- Connect the equipment into an outlet on a circuit different from that to which the receiver is connected.
- Consult the dealer or an experienced radio/TV technician for help.

### **FCC NOTE:**

Caution: Changes or modifications not expressly approved by the party responsible for compliance could void the user's authority to operate the equipment.

## **RF EXPOSURE INFORMATION (SAR)**

This mobile phone is designed and manufactured not to exceed the emission limits for exposure to radio frequency (RF) energy set by the Federal Communications Commission of the United States.

During SAR testing, this device was set to transmit at its highest certified power level in all tested frequency bands, and placed in positions that simulate RF exposure in usage against the head with no separation, and near the body with the separation of 10 mm. Although the SAR is determined at the highest certified power level, the actual SAR level of the device while operating can be well below the maximum value. This is because the phone is designed to operate at multiple power levels so as to use only the power required to reach the network. In general, the closer you are to a wireless base station antenna, the lower the power output.

The exposure standard for wireless devices employing a unit of measurement is known as the Specific Absorption Rate, or SAR.

The SAR limit set by the FCC is 1.6 W/kg.

This mobile phone is compliant with SAR for general population /uncontrolled exposure limits in ANSI/IEEE C95.1-1992 and had been tested in accordance with the measurement methods and procedures specified in IEEE1528. The FCC has granted an Equipment Authorization for this model phone with all reported SAR levels evaluated as in compliance with the FCC RF exposure guidelines. SAR information on this model phone is on file with the FCC and can be found under the Display Grant section of [www.fcc.gov/oet/ea/fccid](http://www.fcc.gov/oet/ea/fccid) after searching on FCC ID: ZL5S52E.

The highest reported SAR values under the FCC regulatory for the phone are listed below:

Head SAR: 1.09 W/kg,

Body SAR: 0.88 W/kg,

Wireless Router SAR: 1.14 W/kg

While there may be differences between the SAR levels of various phones and at various positions, they all meet the government requirements.

SAR compliance for body-worn operation is based on a separation distance of 10 mm between the unit and the human body. Carry this device at least 10 mm away from your body to ensure RF exposure level compliant or lower to the reported level. To support body-worn operation, choose the belt clips or holsters, which do not contain metallic components, to maintain a separation of 10 mm between this device and your body.

RF exposure compliance with any body-worn accessory, which contains metal, was not tested and certified, and as such body-worn accessories should be avoided.

### **DISPOSAL AND RECYCLING INFORMATION**

This symbol on the device (and any included batteries) indicates that they should not be disposed of as normal household garbage. Do not dispose of the device or batteries as unsorted municipal waste. The device (and any batteries) should be handed over to a certified collection point for recycling or proper disposal at the end of their life.



For more detailed information about the recycling of the device or batteries, contact your local city office, the household waste disposal service, or the retail store where you purchased this device.

The disposal of the device is subject to the Waste from Electrical and Electronic Equipment (WEEE) directive of the European Union. The reason for separating WEEE and batteries from other waste is to minimize the potential environmental impacts on human health from any of the hazardous substances that may be present.

### **REDUCTION OF HAZARDOUS SUBSTANCES**

This device is compliant with the EU Registration, Evaluation, Authorization and Restriction of Chemicals (REACH) Regulation (EU Regulation (EC) No 1907/2006 (REACH) of the European Parliament and of the Council) and the EU Restriction of Hazardous Substances (RoHS).

Directive (Directive 2011/65/EU (RoHS) and its amendment directive (EU) 2015/863 of the European Parliament and of the Council). For more information about the REACH compliance of the device, visit the Web site [www.catphones.com/certification](http://www.catphones.com/certification). It is recommended to visit the Web site regularly for up-to-date information.

### **EU REGULATORY CONFORMANCE**

Hereby, the manufacturer declares that this device is compliant with the essential requirements and other relevant provisions of

Directive 2014/53/EU. For the declaration of conformity, visit the website: [www.catphones.com/support/](http://www.catphones.com/support/)

## EU COMPLIANCE STATEMENT

This device is restricted to indoor use only when operating in the 5150 to 5350 MHz frequency range. Restrictions in: Belgium (BE), Bulgaria (BG), Czech Republic (CZ), Denmark (DK), Germany (DE), Estonia (EE), Ireland (IE), Greece (EL), Spain (ES), France (FR), Croatia (HR), Italy (IT), Cyprus (CY), Latvia (LV), Lithuania (LT), Luxembourg (LU), Hungary (HU), Malta (MT), Netherlands (NL), Austria (AT), Poland (PL), Portugal (PT), Romania (RO), Slovenia (SI), Slovakia (SK), Finland (FI), Sweden (SE), United Kingdom (UK), Switzerland (CH), Norway (NO), Iceland (IS), Liechtenstein (LI) and Turkey (TR).

## SPECTRUM AND POWER TABLE

Bands	Conducted Power(dB)
GSM 900	33
GSM 1800	30
WCDMA B1	24
WCDMA B5	24
WCDMA B8	24
FDD-LTE B1	24
FDD-LTE B3	24
FDD-LTE B5	24
FDD-LTE B7	24.5
FDD-LTE B8	24
FDD-LTE B20	24
FDD-LTE B28	24
FDD-LTE B38	24.5
WiFi: 2400 - 2483.5 MHz	20
WiFi: 5150 - 5250 MHz	19
WiFi: 5250 - 5350 MHz	19
WiFi: 5470 - 5725 MHz	19
WiFi: 5745 - 5825 MHz	19
Bluetooth: 2400 - 2483.5 MHz	9.5
NFC: 13.56 MHz	7.09 dBuA/m

### NOTE:

Observe the national local regulations in the location where the device is to be used. This device may be restricted for use in some or all member states of the European Union (EU).

Some bands may not be available in all countries or all areas. Please contact the local carrier for more details.

Maximum radio-frequency power transmitted in the frequency bands in which the radio equipment operates:

The maximum power for all bands is less than the highest limit value specified in the related Harmonised Standard.

The frequency bands and transmitting power nominal limits applicable to this radio equipment are as follows:

Google, Android, Google Play and other marks are trademarks of Google LLC.

**CAT® S52 SPECIFICATION**

<b>Operation System</b>	Android 9 Pie
<b>Processor</b>	QCT SDM630, Octa Core
<b>Memory</b>	<ul style="list-style-type: none"><li>• Internal Memory: 64GB eMMC / 4GB RAM LPDDR4</li><li>• External Memory: SDXC, Class 10/Ultra high speed/up to 200GB</li></ul>
<b>Cellular Network</b>	LTE: 1/ 2/ 3/ 4/ 5/ 7/ 8/ 20/ 28/ 38 WCDMA: 1/ 2/ 4/ 5/ 8 GSM; 850/ 900/ 1800/ 1900
<b>Display</b>	Size 5.65" HD+ with wet finger & glove support, GG6
<b>Camera</b>	<ul style="list-style-type: none"><li>• Rear Camera: 12MP Dual cell PDAF single LED flash</li><li>• Front Camera: 8MP</li></ul>
<b>Sensor</b>	<ul style="list-style-type: none"><li>• Ambient Light</li><li>• Accelerometer</li><li>• Gyroscope</li><li>• Compass</li><li>• Proximity</li></ul>
<b>Connectivity</b>	<ul style="list-style-type: none"><li>• Audio jack: 3.5mm</li><li>• Bluetooth: 5.0</li><li>• USB: USB 2.0 (Type C)</li><li>• WiFi 802.11 a/b/g/n/ac</li><li>• GPS, aGPS, GLONASS, Gaileo, EGNOS, SBAS</li><li>• FM Radio with RDS</li><li>• NFC</li><li>• SIM type: Nano SIM</li></ul>
<b>Battery</b>	3100mAH
<b>Others</b>	Ingress Protection: IP68 Drop: 1.5m
<b>Dimensions</b>	158.11 x 76.70 x 9.89mm
<b>Weights</b>	210g

\* Design and specifications are subject to change without prior notice.

## DECLARATION OF CONFORMITY

### Manufacturer:

Name: Bullitt Mobile Limited

Address: One Valpy, Valpy Street, Reading, RG1 1AR, Berkshire, UK

### Radio Equipment:

Model: S52

Object of the Declaration: Rugged Smart Phone

Software version: LTE\_D0201121.1\_S52

Supplied Accessories and Components: AC Adapter, USB cable, Earphone

We, Bullitt Mobile Limited, declare under our sole responsibility that the product described above is in conformity with the relevant Union harmonization legislations:

**RE Directive (2014/53/EU), RoHS Directive (2011/65/EU) and (EU)2015/863**

The following harmonized standards and/or other relevant standards have been applied:

1. **Health and Safety (Article 3.1(a) of the RE Directive)**
  - EN 62311:2008, EN 62479:2010
  - EN 50360:2017, EN 62209-1:2016
  - EN 50566:2017, EN 62209-2:2010+A1:2019, EN 50663:2017
  - EN 60950-1:2006/A11:2009+A1:2010+A12:2011+A2:2013
  - EN 50332-1 :2013, EN50332-2 :2013
2. **Electromagnetic compatibility (Article 3.1 (b) of the RE Directive)**
  - Draft EN 301 489-1 V2.2.0, EN 301 489-3 V2.1.1
  - Draft EN 301 489-17 V3.2.0, EN 301 489-19 V2.1.1, Draft EN 301 489-52 V1.1.0
  - EN 55032:2015/AC:2016 Class B, EN 55035:2017
3. **Radio frequency spectrum usage (Article 3.2 of the RE Directive)**
  - EN 301 511 V12.5.1
  - EN 301 908-1 V11.1.1, EN 301 908-2 V11.1.2, EN 301 908-13 V11.1.2
  - EN 300 328 V2.2.2, EN 301 893 V2.1.1
  - EN 300 440 V2.2.1
  - EN 303 413 V1.1.1
  - EN 300 330 V2.1.1
  - EN 303 345-1 V1.1.1 / Draft EN 303 345-3 V0.0.10

The notified body (Name: **Telefication**, ID: **0560**) performed the conformity assessment according to Annex III, Module B of the Radio Equipment Directive 2014/53/EU and issued the EU-type examination certificate (Ref. No.: 192140457/AA/00) covering the essential requirements of article(s) 3.1a, 3.1b, 3.2.

**Signed for and on behalf of:** Bullitt Mobile Limited

**Address:** One Valpy, Valpy Street, Reading, RG1 1AR, Berkshire, UK

**Date:** October 17, 2019

**Name:** Arlen Huang, Function: Director of Quality, **Signature:**







© 2019 Caterpillar. All Rights Reserved. CAT, CATERPILLAR, LET'S DO THE WORK, their respective logos, "Caterpillar Yellow", the "Power Edge" and Cat "Modern Hex" trade dress as well as corporate and product identity used herein, are trademarks of Caterpillar and may not be used without permission. [www.cat.com](http://www.cat.com) / [www.caterpillar.com](http://www.caterpillar.com)

Bullitt Mobile Ltd. is a licensee of Caterpillar Inc.

Bullitt Mobile Ltd.'s and third-party trademarks are the property of their respective owners.