



Maintenance and Service Guide

SUMMARY

This guide provides information about spare parts, removal and replacement of parts, security, backing up, and more.

© Copyright 2022 HP Development Company, L.P.

AMD is a trademark of Advanced Micro Devices, Inc. Bluetooth is a trademark owned by its proprietor and used by HP Inc. under license. The terms HDMI, HDMI High-Definition Multimedia Interface, and the HDMI Logo are trademarks or registered trademarks of HDMI Licensing Administrator, Inc. Intel, Core, and Iris are trademarks of Intel Corporation or its subsidiaries in the U.S. and/or other countries. Microsoft and Windows are either registered trademarks or trademarks of Microsoft Corporation in the United States and/or other countries. USB Type-C and USB-C are registered trademarks of USB Implementers Forum. Miracast® and Wi-Fi are registered trademarks of Wi-Fi Alliance.

The information contained herein is subject to change without notice. The only warranties for HP products and services are set forth in the express warranty statements accompanying such products and services. Nothing herein should be construed as constituting an additional warranty. HP shall not be liable for technical or editorial errors or omissions contained herein.

First Edition: May 2022

Document Part Number: N12015-001

Product notice

This guide describes features that are common to most models. Some features may not be available on your computer.

Not all features are available in all editions or versions of Windows. Systems may require upgraded and/or separately purchased hardware, drivers, software or BIOS update to take full advantage of Windows functionality. Windows is automatically updated, which is always enabled. High-speed internet and Microsoft account required. ISP fees may apply and additional requirements may apply over time for updates. See <http://www.windows.com>. **If your product ships with Windows in S Mode:** Windows in S Mode works exclusively with apps from the Microsoft Store within Windows. Certain default settings, features, and apps cannot be changed. Some accessories and apps that are compatible with Windows may not work (including some antivirus, PDF writers, driver utilities, and accessibility apps), and performance may vary, even if you switch out of S Mode. If you switch to Windows, you cannot switch back to S Mode. Learn more at [Windows.com/SmodeFAQ](https://www.windows.com/SmodeFAQ).

To access the latest user guides, go to <http://www.hp.com/support>, and follow the instructions to find your product. Then select **Manuals**.

Software terms

By installing, copying, downloading, or otherwise using any software product preinstalled on this computer, you agree to be bound by the terms of the HP End User License Agreement (EULA). If you do not accept these license terms, your sole remedy is to return the entire unused product (hardware and software) within 14 days for a full refund subject to the refund policy of your seller.

For any further information or to request a full refund of the price of the computer, please contact your seller.

Safety warning notice

Reduce the possibility of heat-related injuries or of overheating the computer by following the practices described.

⚠ WARNING! To reduce the possibility of heat-related injuries or of overheating the computer, do not place the computer directly on your lap or obstruct the computer air vents. Use the computer only on a hard, flat surface. Do not allow another hard surface, such as an adjoining optional printer, or a soft surface, such as pillows or rugs or clothing, to block airflow. Also, do not allow the AC adapter to come into contact with the skin or a soft surface, such as pillows or rugs or clothing, during operation. The computer and the AC adapter comply with the user-accessible surface temperature limits defined by applicable safety standards.

Table of contents

1 Product description	1
2 Components	4
Right	4
Left	5
Display	6
Low blue light mode (select products only)	6
Keyboard area	7
Touchpad	7
Touchpad settings	7
Adjusting touchpad settings	7
Turning on the touchpad	7
Touchpad components	8
Special keys	8
Labels	10
3 Illustrated parts catalog	12
Computer major components	12
Display assembly subcomponents	14
Miscellaneous parts	15
4 Removal and replacement procedures preliminary requirements	19
Tools required	19
Service considerations	19
Plastic parts	19
Cables and connectors	19
Drive handling	19
Electrostatic discharge information	20
Generating static electricity	20
Preventing electrostatic damage to equipment	21
Personal grounding methods and equipment	21
Grounding the work area	22
Recommended materials and equipment	22
Cleaning your computer	23
Enabling HP Easy Clean (select products only)	23
Removing dirt and debris from your computer	23
Cleaning your computer with a disinfectant	24
Caring for wood veneer (select products only)	25
Packaging and transporting guidelines	25
Accessing support information	25

5 Removal and replacement procedures for authorized service provider parts	28
Component replacement procedures.....	28
Preparation for disassembly	28
Bottom cover	28
Battery	29
WLAN module	30
Solid-state drive	32
RTC battery	33
USB/audio board	34
Speaker	35
Touchpad	36
Heat sink	37
Power connector cable	39
System board.....	40
Display assembly.....	42
Top cover with keyboard.....	49
6 Computer Setup (BIOS), TPM, and HP Sure Start	51
Using Computer Setup.....	51
Navigating and selecting in Computer Setup	51
Restoring factory settings in Computer Setup	51
Updating the BIOS.....	52
Determining the BIOS version	52
Preparing for a BIOS update	52
Downloading a BIOS update	53
Installing a BIOS update	53
Changing the boot order using the f9 prompt	53
TPM BIOS settings (select products only)	54
Using HP Sure Start (select products only)	54
7 Backing up, restoring, and recovering	55
Backing up information and creating recovery media.....	55
Using Windows tools for backing up	55
Using the HP Cloud Recovery Download Tool to create recovery media (select products only).....	55
Restoring and recovering your system	55
Creating a system restore	56
Restoring and recovery methods	56
Recovering using HP Recovery media	56
Changing the computer boot order.....	57
Using HP Sure Recover (select products only)	57
8 Using HP PC Hardware Diagnostics	58
Using HP PC Hardware Diagnostics Windows (select products only)	58
Using an HP PC Hardware Diagnostics Windows hardware failure ID code	58
Accessing HP PC Hardware Diagnostics Windows.....	58
Accessing HP PC Hardware Diagnostics Windows from HP Help and Support (select products only).....	58
Accessing HP PC Hardware Diagnostics Windows from HP Support Assistant	59
Accessing HP PC Hardware Diagnostics Windows from the Start menu (select products only).....	59

Downloading HP PC Hardware Diagnostics Windows	59
Downloading the latest HP PC Hardware Diagnostics Windows version from HP	59
Downloading the HP PC Hardware Diagnostics Windows from the Microsoft Store.....	59
Downloading HP Hardware Diagnostics Windows by product name or number (select products only)	60
Installing HP PC Hardware Diagnostics Windows	60
Using HP PC Hardware Diagnostics UEFI	60
Using an HP PC Hardware Diagnostics UEFI hardware failure ID code	60
Starting HP PC Hardware Diagnostics UEFI.....	61
Downloading HP PC Hardware Diagnostics UEFI to a USB flash drive	61
Downloading the latest HP PC Hardware Diagnostics UEFI version	61
Downloading HP PC Hardware Diagnostics UEFI by product name or number (select products only).....	62
Using Remote HP PC Hardware Diagnostics UEFI settings (select products only)	62
Downloading Remote HP PC Hardware Diagnostics UEFI	62
Downloading the latest Remote HP PC Hardware Diagnostics UEFI version	62
Downloading Remote HP PC Hardware Diagnostics UEFI by product name or number	62
Customizing Remote HP PC Hardware Diagnostics UEFI settings	62
9 Specifications	64
Computer specifications	64
35.6 cm (14.0in) display specifications	65
10 Statement of memory volatility	66
Current BIOS steps	66
Nonvolatile memory usage	68
Questions and answers	70
Using HP Sure Start (select products only)	72
11 Power cord set requirements	73
Requirements for all countries.....	73
Requirements for specific countries and regions	73
12 Recycling.....	75
Index	76

1 Product description

This table provides detailed product information.

Table 1-1 Product components and their descriptions

Category	Description
Product Name	HP ProBook Fortis 14 inch G10 Notebook PC
Processors	Intel® processors Intel Core® i5-1230U (1.0 GHz base frequency, up to 4.4 GHz with Intel Turbo Boost Technology, 10 MB cache, 10 cores) Intel Core i3-1210U (1.0 GHz base frequency, up to 2.8 GHz with Intel Turbo Boost Technology, 10 MB cache, 6 cores)
Graphics	Internal graphics Intel® Iris® Xe
Display	35.6 cm (14.0 in), light emitting diode (LED), antiglare, narrow bezel, embedded DisplayPort (eDP), 250 nits Full high definition (FHD) (1920 × 1080), ultra wide viewing angle (UWVA) FHD, UWVA, touch-on panel (TOP) High definition (HD) (1366 × 768), standard viewing angle (SVA)
Memory	Integrated memory supporting 32 GB of RAM, nonupgradeable LPDDR4X-4266
Primary storage	Solid-state drive (M.2 2230, PCIe) 256 GB 128 GB
Audio and video	HD camera 720p Dual-array microphone Dual speakers
Wireless network	Wireless local area network (WLAN) <ul style="list-style-type: none">Intel® AX211 Wi-Fi® 6e Bluetooth® 5.2 WLANIntel 9560 802.11b/g/n/a/ac (2 × 2) and Bluetooth 5 Support for Miracast™ Support for UEFI Wi-Fi Supports HP Connection Optimizer Supports HP Extended Range Wireless LAN Supports dynamic antenna gain
Wired network	RTK GBE Ethernet Controller (Non-DASH QFN32) RTL8111HSH-CG

Table 1-1 Product components and their descriptions (continued)

Category	Description
Ports	Audio-out (headphone)/audio-in (microphone) combo jack
	HDMI™ v1.4b
	AC Smart Pin adapter plug, 4.5 mm
	(2) USB 3.1 Gen 1 Type A
	USB Type-C® 3.1 Gen 1, supports:
	- Power delivery - Data transfer
Keyboard/pointing devices	Notebook keyboard
	Spill resistant
	Clickpad
Power requirements	Battery
	3 cell, 42 Whr, long-life polymer
	HP Fast Charge Technology
	AC adapters
	45 W, non-power correction factor (nPFC), standard barrel, 1.8 m (6 ft)
	45 W, nPFC, right angle, standard barrel, LA MERCO
	45 W, nPFC, USB Type-C
	Power cord
	C5, 1.0 m (3.3 ft), conventional
Operating system	Windows® 10 Enterprise 64
	Windows 10 Enterprise 64 LTSC 2109
	Windows 11 Enterprise 64
	Windows 11 Home 64
	Windows 11 Home 64 Single Language
	Windows 11 Home 64 Single Language Africa Market CCC
	Windows 11 Home 64 StF MSNA for Higher Education
	Windows 11 Home 64 StF MSNA for Higher Education Strategic
	Windows 11 Pro 64
	Windows 11 Pro 64 Downgrade Windows 10 Pro 64
	Windows 11 Pro 64 Downgrade Windows 10 Pro 64 StF MSNA Standard
	Windows 11 Pro 64 Downgrade Windows 10 Pro 64 StF MSNA Strategic
	Windows 11 Pro 64 Downgrade Windows 10 Pro 64 Value
	Windows 11 Pro 64 StF MSNA Standard
	Windows 11 Pro 64 StF MSNA Strategic

Table 1-1 Product components and their descriptions (continued)

Category	Description
	Windows 11 Pro 4 Value
	FreeDOS 3.0
Serviceability	End user replaceable parts
	AC adapter

2 Components



Your computer features top-rated components. This chapter provides details about your components, where they are located, and how they work.

Right

Use the illustration and table to identify the components on the right side of the computer.



Table 2-1 Right-side components and their descriptions

Component	Description
(1) 	<p>Audio-out (headphone)/Audio-in (microphone) combo jack</p> <p>WARNING! To reduce the risk of personal injury, adjust the volume before putting on headphones, earbuds, or a headset. For additional safety information, see the <i>Regulatory, Safety, and Environmental Notices</i>.</p> <p>To access this guide:</p> <ul style="list-style-type: none">▲ Select the Search icon (select products only) in the taskbar, type <code>HP Documentation</code> in the search box, and then select HP Documentation. <p>NOTE: When a device is connected to the jack, the computer speakers are disabled.</p>
(2) 	<p>USB SuperSpeed 5 Gbps port</p> <p>NOTE: Use a standard USB Type-A charging cable or cable adapter (purchased separately) when charging a small external device.</p>
(3)	<p>Security cable slot</p> <p>NOTE: The security cable is designed to act as a deterrent, but it might not prevent the computer from being mishandled or stolen.</p>

Left

Use the illustration and table to identify the components on the left side of the computer.

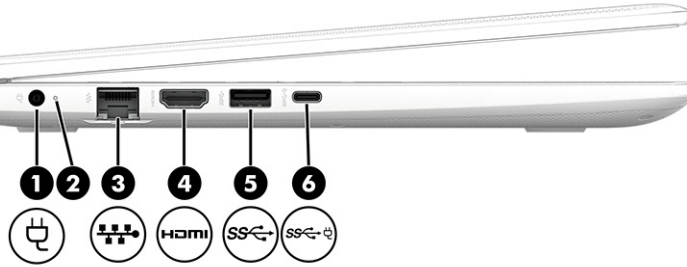







Table 2-2 Left-side components and their descriptions

Component	Description
(1) 	Power connector Connects an AC adapter.
(2) 	Battery light When AC power is connected: <ul style="list-style-type: none"> White: The battery charge is greater than 90 percent. Amber: The battery charge is from 0 to 90 percent. Off: The battery is not charging. When AC power is disconnected (battery not charging): <ul style="list-style-type: none"> Blinking amber: The battery has reached a low battery level. When the battery has reached a critical battery level, the battery light begins blinking rapidly. Off: The battery is not charging.
(3) 	RJ-45 (network) jack/status lights Connects a network cable. <ul style="list-style-type: none"> Green (left): The network is connected. Amber (right): Activity is occurring on the network.
(4) 	HDMI port Connects an optional video or audio device, such as a high-definition television, any compatible digital or audio component, or a high-speed High Definition Multimedia Interface (HDMI) device.
(5) 	USB SuperSpeed 5 Gbps port Connects a USB device, provides high-speed data transfer, and (for select products) charges small devices (such as a smartphone) when the computer is on or in Sleep mode. NOTE: Use a standard USB Type-A charging cable or cable adapter (purchased separately) when charging a small external device.
(6) 	USB Type-C power connector and SuperSpeed 5 Gbps port Connects an AC adapter that has a USB Type-C connector, supplying power to the computer and, if needed, charging the computer battery.

– and –

Table 2-2 Left-side components and their descriptions (continued)

Component	Description
	Connects a USB device, provides high-speed data transfer, and (for select products) charges small devices (such as a smartphone) when the computer is on or in Sleep mode.
	NOTE: Use a standard USB Type-C charging cable or cable adapter (purchased separately) when charging a small external device.

Display

Use the illustration and table to identify the display components.

Low blue light mode (select products only)

Your computer display is shipped from the factory in low blue light mode for improved eye comfort and safety. Also, blue light mode automatically adjusts blue light emissions when you are using the computer at night or for reading.

⚠ WARNING! To reduce the risk of serious injury, read the *Safety & Comfort Guide*. It describes proper workstation setup and proper posture, health, and work habits for computer users. The *Safety & Comfort Guide* also provides important electrical and mechanical safety information. The *Safety & Comfort Guide* is available on the web at <http://www.hp.com/ergo>.

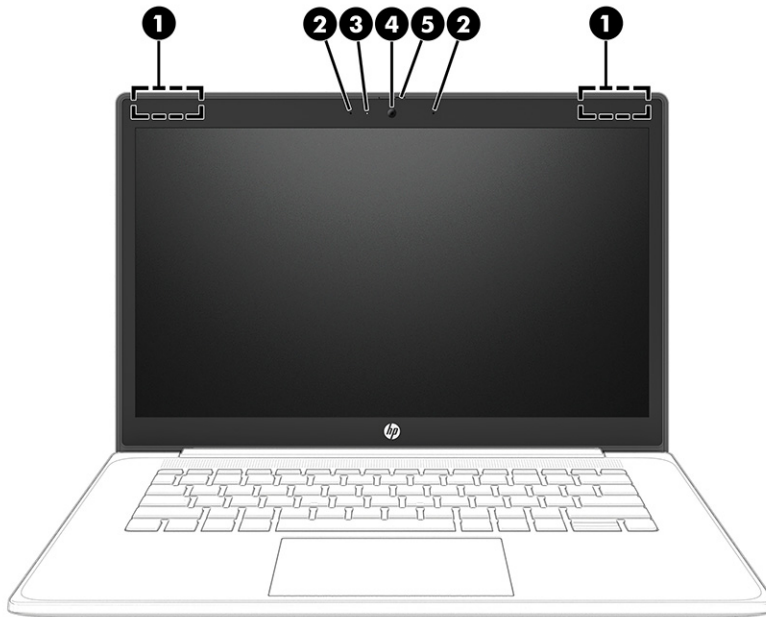

Table 2-3 Display components and their descriptions

Component	Description
(1) WLAN antennas*	Send and receive wireless signals to communicate with wireless local area networks (WLANs).

Table 2-3 Display components and their descriptions (continued)

Component	Description
(2) Internal microphones	Record sound.
(3) Camera light	On: The camera is in use.
(4) Camera	Allows you to video chat, record video, and record still images. Some cameras also allow a facial recognition logon to Windows, instead of a password logon. NOTE: Camera functions vary depending on the camera hardware and software installed on your product.
(5) Camera privacy cover	By default, the camera lens is uncovered, but you can slide the camera privacy cover to block the camera's view. To use the camera, slide the camera privacy cover in the opposite direction to reveal the lens.

*The antennas are not visible from the outside of the computer. For optimal transmission, keep the areas immediately around the antennas free from obstructions.

For wireless regulatory notices, see the section of the *Regulatory, Safety, and Environmental Notices* that applies to your country or region.

To access this guide:

- ▲ Select the **Search** icon (select products only) in the taskbar, type `HP Documentation` in the search box, and then select **HP Documentation**.

Keyboard area

Keyboards can vary by language.



NOTE: The keyboard, including the function keys and power key (select products only), is disabled in stand, tent, and tablet modes. To enable the keyboard, including the power key, change to the clamshell mode.

Touchpad

The touchpad settings and components are described here.

Touchpad settings

You learn how to adjust the touchpad settings and components here.

Adjusting touchpad settings

Use these steps to adjust touchpad settings and gestures.

1. Select the **Search** icon (select products only) in the taskbar, type `touchpad settings` in the search box, and then press `enter`.
2. Choose a setting.

Turning on the touchpad

Follow these steps to turn on the touchpad.

1. Select the **Search** icon (select products only) in the taskbar, type `touchpad settings` in the search box, and then press `enter`.
2. Using an external mouse, click the **Touchpad** button.

If you are not using an external mouse, press the `Tab` key repeatedly until the pointer rests on the **touchpad** button. Then press the `spacebar` to select the button.

Touchpad components

Use the illustration and table to identify the touchpad components.

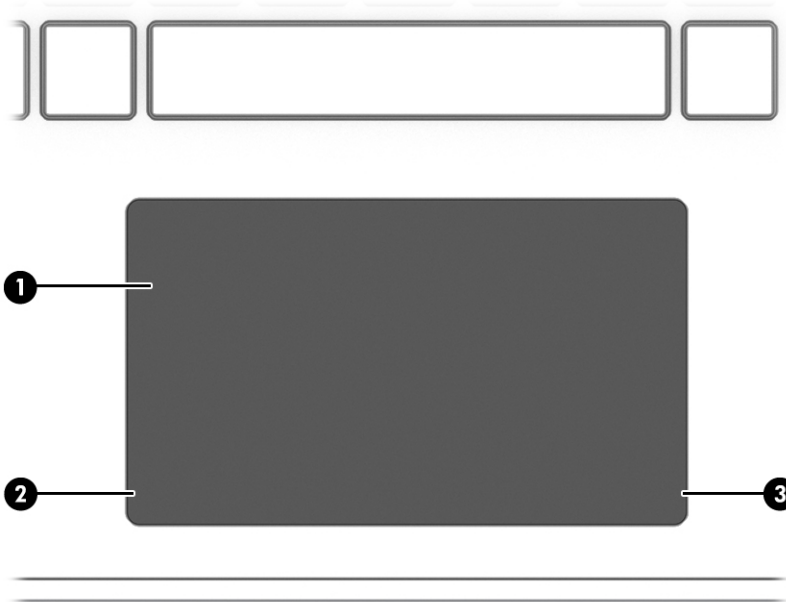

Table 2-4 Touchpad components and their descriptions

Component	Description
(1) Touchpad zone	Reads your finger gestures to move the pointer or activate items on the screen.
(2) Left touchpad button	Functions like the left button on an external mouse.
(3) Right touchpad button	Functions like the right button on an external mouse.

Special keys

Use the illustration and table to identify the special keys.

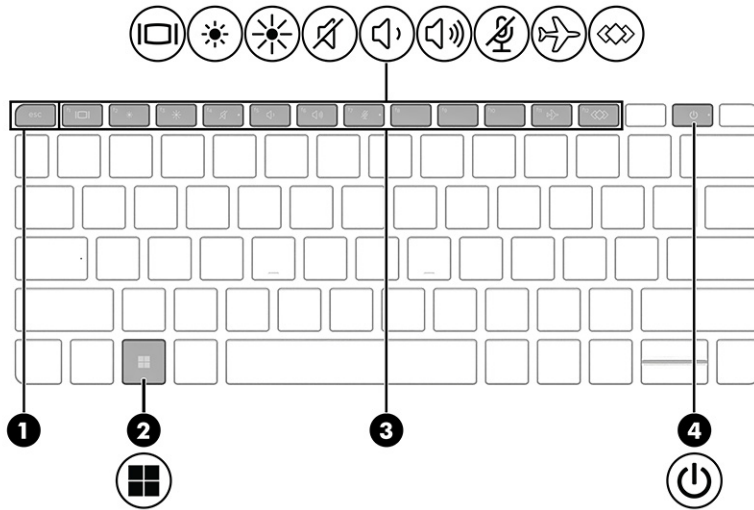





Table 2-5 Special keys and their descriptions

Component	Description
(1) <code>esc</code> key	Displays system information when pressed in combination with the <code>fn</code> key.
(2) Windows key	Opens the Start menu. NOTE: Pressing the Windows key again will close the Start menu.
(3) Action keys	Execute frequently used system functions.
(4)  Power key	<ul style="list-style-type: none"> When the computer is off, press the key briefly to turn on the computer. When the computer is on, press the key briefly to initiate Sleep. When the computer is in the Sleep state, press the key briefly to exit Sleep (select products only). When the computer is in Hibernation, press the key briefly to exit Hibernation. <p>IMPORTANT: Pressing and holding down the power key results in the loss of unsaved information.</p> <p>If the computer has stopped responding and shutdown procedures are ineffective, press and hold the power key for at least 4 seconds to turn off the computer.</p> <p>To learn more about your power settings, use the Power icon.</p> <ul style="list-style-type: none"> Right-click the Power icon  and then, depending on your product, select Power and sleep settings or Power Options.

Labels

The labels affixed to the computer provide information you might need when you troubleshoot system problems or travel internationally with the computer. Labels might be in paper form or imprinted on the product.

 **IMPORTANT:** Check the following locations for the labels described in this section: the bottom of the computer, inside the battery bay, under the service door, on the back of the display, or on the bottom of a tablet kickstand.

- Service label—Provides important information to identify your computer. When contacting support, you might be asked for the serial number, the product number, or the model number. Locate this information before you contact support.

Your service label will resemble one of the examples shown below. Refer to the illustration that most closely matches the service label on your computer.

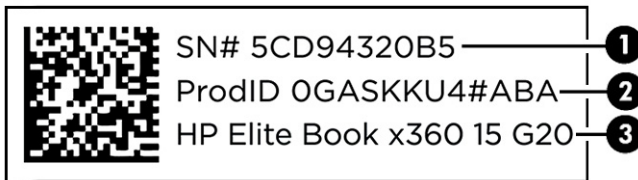

Table 2-6 Service label components

Component
(1) Serial number
(2) Product ID
(3) HP product name

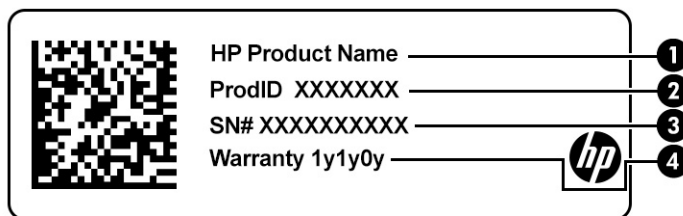

Table 2-7 Service label components

Component
(1) HP product name
(2) Product ID
(3) Serial number
(4) Warranty period

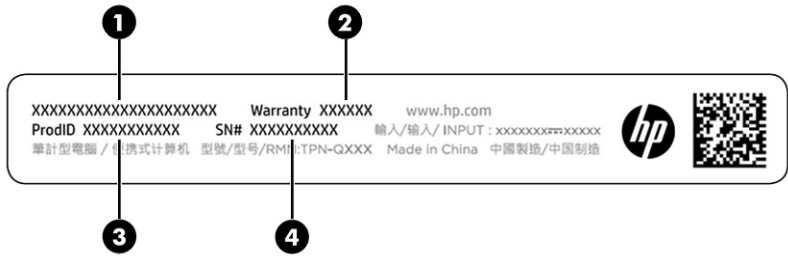

Table 2-8 Service label components

Component	
(1)	HP product name
(2)	Warranty period
(3)	Product ID
(4)	Serial number

- Regulatory labels—Provide regulatory information about the computer.
- Wireless certification labels—Provide information about optional wireless devices and the approval markings for the countries or regions in which the devices have been approved for use.

3 Illustrated parts catalog

Use this chapter to determine the spare parts that are available for the computer.

Computer major components

To identify the computer major components, use this illustration and table.

 **NOTE:** HP continually improves and changes product parts. For complete and current information about supported parts for your computer, go to <http://partsurfer.hp.com>, select your country or region, and then follow the on-screen instructions.

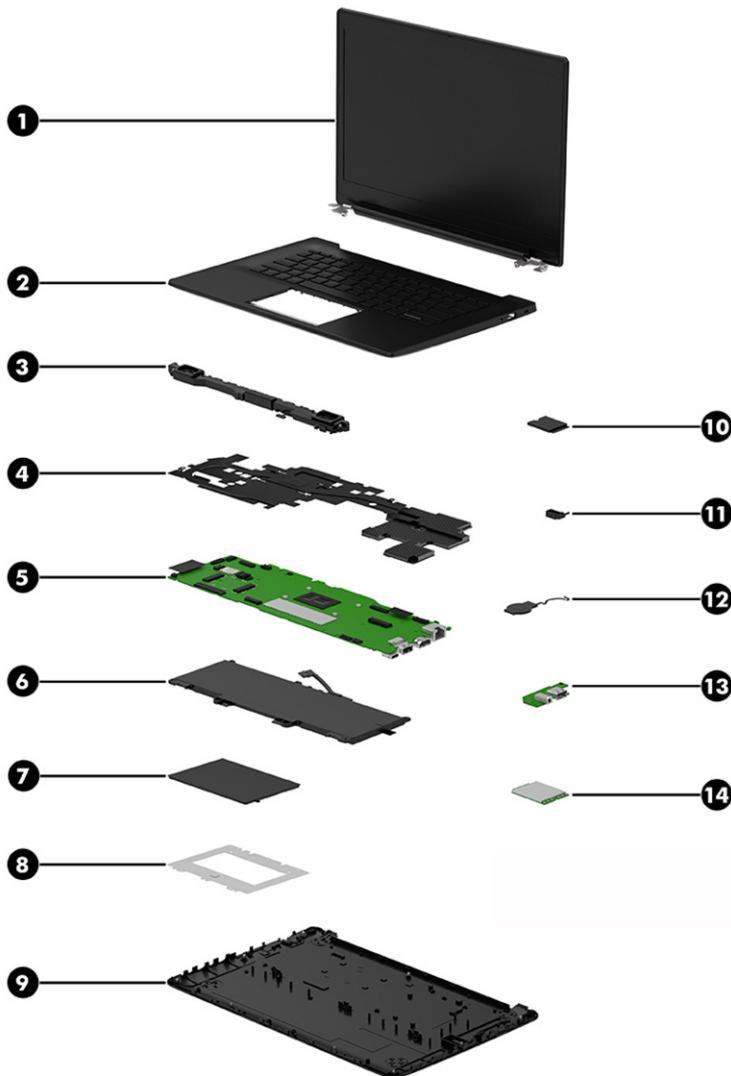

Table 3-1 Computer major component descriptions and part numbers

Item	Component	Spare part number
(1)	Display assembly NOTE: Display assemblies are available only as subcomponents. For spare part information, see Display assembly subcomponents on page 14 .	
(2)	Top cover with keyboard NOTE: For a detailed list of country codes, see Top cover with keyboard on page 49 .	N14832-xx1
(3)	Speaker	N07104-001
(4)	Heat sink NOTE: Thermal grease is available as spare part number M86388-001.	N20164-001
(5)	System board (includes integrated processor) NOTE: All system board spare part kits include replacement thermal material. All system boards use the following part numbers: xxxxxx-001: Non-Windows operating systems xxxxxx-601: Windows operating system	
	Intel Core i5-1230U processor and 8 GB of system memory	N15444-xx1
	Intel Core i3-1210U processor and 8 GB of system memory	N15443-xx1
	Intel Core i3-1210U processor and 4 GB of system memory	N15442-xx1
(6)	Battery (3 cell, 42 Whr)	M73474-005
(7)	Touchpad NOTE: The touchpad cable is available in the Cable Kit as spare part number N20852-001.	N00689-001
(8)	Touchpad bracket	not available as a spare part
(9)	Bottom cover	N14831-001
(10)	Solid-state drive (PCIe, 2230) NOTE: The solid-state drive cover is available in the Bracket Kit as spare part number N07102-001.	
	256 GB	M11042-002
	128 GB	M11040-002
(11)	Power connector NOTE: The power connector bracket is available in the Bracket Kit as spare part number N07102-001.	N02674-001
(12)	RTC battery	L43797-001
(13)	USB/audio board NOTE: The USB/audio board cable is available in the Cable Kit as spare part number N20852-001. The USB/audio board bracket is available in the Bracket Kit as spare part number N07102-001.	N07103-001
(14)	WLAN module Intel 9560 802.11b/g/n/a/ac (2 × 2) and Bluetooth 5	L22634-002

Table 3-1 Computer major component descriptions and part numbers (continued)

Item	Component	Spare part number
	Intel AX211 Wi-Fi 6e Bluetooth 5.2 WLAN	M53366-002

Display assembly subcomponents

To identify the display assembly subcomponents, use this illustration and table.

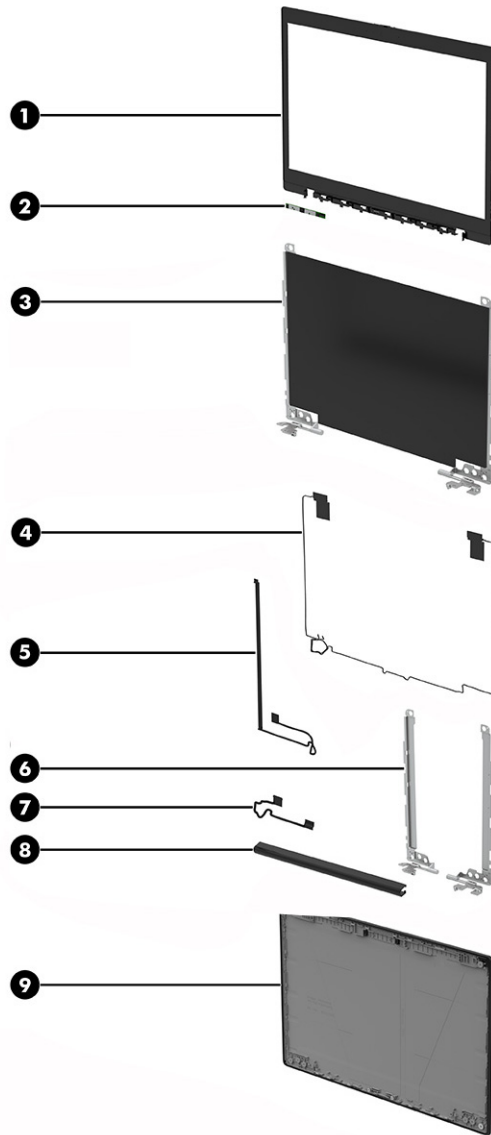

Table 3-2 Display component descriptions and part numbers

Item	Component	Spare part number
(1)	Bezel	N07100-001

Table 3-2 Display component descriptions and part numbers (continued)

Item	Component	Spare part number
(2)	Camera module	N07105-001
(3)	Display panel (includes hinge brackets)	
	FHD, antiglare, UWVA, nontouch	N08932-001
	FHD, antiglare, UWVA, touch-on panel (TOP)	N08933-001
	HD, antiglare, SVA, nontouch	N08935-001
(4)	WLAN antenna and cables	N07099-001
(5)	Camera cable (in Cable Kit)	N07101-001
(6)	Hinge brackets (included in the Hinge Kit)	N00687-001
(7)	Display cable	N07110-001
(8)	Hinge cover (included in the Hinge Kit, includes tape)	N00687-001
(9)	Display back cover	N00685-001

Miscellaneous parts

To identify the miscellaneous parts, use this table.

Table 3-3 Miscellaneous part descriptions and part numbers

Component	Spare part number
AC adapter	
120 W, power factor correction (PFC), 4.5 mm	M95377-001
65 W, non-power factor correction (nPFC), 3 pin, 4.5 mm	710412-001
65 W, nPFC, USB-C®, 1.8 m (6.0 ft)	L32392-001
45 W, nPFC, 4.5 mm	741727-001
45 W, nPFC, USB-C	860210-850
45 W, nPFC, wall mount, 1.8 m (6.0 ft)	L32390-001
65 W USB-C AC adapter + 1.8 m (6.0 ft) power cord	
Argentina	L43180-001
Denmark	L43180-004
Europe (Austria, Belgium, Finland, France, Germany, the Netherlands, Norway, and Sweden)	L43180-005
Israel	L43180-006
Italy	L43180-008
North America	L43180-010
South Africa	L43180-012
Switzerland	L43180-013

Table 3-3 Miscellaneous part descriptions and part numbers (continued)

Component	Spare part number
United Kingdom	L43180-016
45 W USB-C AC adapter + 1.8 m (6.0 ft) power cord	
Argentina	L43182-001
Denmark	L43182-004
Europe (Austria, Belgium, Finland, France, Germany, the Netherlands, Norway, and Sweden)	L43182-005
Israel	L43182-006
Italy	L43182-008
North America	L43182-010
South Africa	L43182-012
Switzerland	L43182-013
United Kingdom	L43182-016
Screw Kit (for use with HP USB-C Dock G5)	L64089-001
Screw Kit (primary kit for computer)	N00688-001
WLAN Plastic Kit (includes switch cover gasket, fan gasket, NI/CU boss gasket, and WLAN insulator with adhesive)	N07109-001
Bracket Kit (includes memory cover, left I/O bracket, USB-C bracket, solid-state drive cover, audio board bracket, touchpad dimple, and power connector cable bracket)	N07102-001
USB-C-to-RJ-45 (network) adapter	918779-001
USB-C-to-VGA adapter	831751-001
USB 3.0-to-Gigabit adapter	914031-001
USB-C-to-USB 3.0 adapter	814618-001
USB-C-to-USB-A adapter	L65254-001
USB-C-to-DisplayPort adapter	831753-001
HDMI-to-DVI-D adapter	691227-001
HDMI-to-VGA adapter	701943-001
USB-C-to-HDMI 2.0 adapter	935325-001
USB-C (male)-to-USB-C (male) adapter	L65253-001
USB-C-to-USB-A hub	916838-001
HP external AC adapter adapter, 7.4 mm	734734-001
HP Sure Key Cable Lock	L65088-001
HP Nano Lock	918431-001
USB laser mouse	674318-001
USB travel mouse	757770-001
Bluetooth travel mouse	L62043-001
HP USB-C Mini Dock	935327-001

Table 3-3 Miscellaneous part descriptions and part numbers (continued)

Component	Spare part number
HP USB-C Dock (with cable)	L64086-001
HP USB-C/A Universal Dock (with cable)	L64087-001
USB-C/A Universal Dock	L64088-001
HP USB-C Dock	L65256-001
HP Business 17.3 Laptop Backpack	M55004-001
HP Prelude Pro 15.6 Backpack	M03617-001
HP Business 14.1 Laptop Case	M55007-001
USB external DVD+RW drive	747080-001
Power cord (C5, conventional, 1.0 m [3.3 ft])	
Argentina	L19357-001
Denmark	L19360-001
Europe (Austria, Belgium, Finland, France, Germany, the Netherlands, Norway, and Sweden)	L19361-001
Israel	L19362-001
Italy	L19364-001
North America	L19367-001
South Africa	L19369-001
Switzerland	L19370-001
United Kingdom	L19373-001
Power cord (C5, conventional, 1.8 m [6.0 ft])	
Argentina	L19357-002
Denmark	L19360-002
Europe (Austria, Belgium, Finland, France, Germany, the Netherlands, Norway, and Sweden)	L19361-002
Israel	L19362-002
Italy	L19364-002
North America	L19367-002
South Africa	L19369-002
Switzerland	L19370-002
United Kingdom	L19373-002
Power cord (C5, premium, duckhead, 1.0 m [3.3 ft])	
Argentina	L36815-001
Denmark	L36817-001
Europe (Austria, Belgium, Finland, France, Germany, the Netherlands, Norway, and Sweden)	L36818-001
Israel	L36819-001
Italy	L44788-001

Table 3-3 Miscellaneous part descriptions and part numbers (continued)

Component	Spare part number
North America	L36822-001
South Africa	L36824-001
Switzerland	L36825-001
United Kingdom	L36828-001

4 Removal and replacement procedures preliminary requirements

Use this information to properly prepare to disassemble and reassemble the computer.

Tools required

You need the following tools to complete the removal and replacement procedures:

- Tweezers
- Nonconductive, nonmarking pry tool
- Magnetic Phillips P1 screwdriver

Service considerations

The following sections include some of the considerations that you must keep in mind during disassembly and assembly procedures.

 **NOTE:** As you remove each subassembly from the computer, place the subassembly (and all accompanying screws) away from the work area to prevent damage.

Plastic parts

Using excessive force during disassembly and reassembly can damage plastic parts.

Cables and connectors

Handle cables with extreme care to avoid damage.

 **IMPORTANT:** When servicing the computer, be sure that cables are placed in their proper locations during the reassembly process. Improper cable placement can damage the computer.

Apply only the tension required to unseat or seat the cables during removal and insertion. Handle cables by the connector whenever possible. In all cases, avoid bending, twisting, or tearing cables. Be sure that cables are routed so that they cannot be caught or snagged as you remove or replace parts. Handle flex cables with extreme care; these cables tear easily.

Drive handling

Note the following guidelines when handling drives.

 **IMPORTANT:** Drives are fragile components. Handle them with care. To prevent damage to the computer, damage to a drive, or loss of information, observe these precautions:

- Before removing or inserting a hard drive, shut down the computer. If you are unsure whether the computer is off or in Hibernation, turn the computer on, and then shut it down through the operating system.
 - Before handling a drive, be sure that you are discharged of static electricity. While handling a drive, avoid touching the connector.
 - Before removing an optical drive, be sure that a disc is not in the drive, and be sure that the optical drive tray is closed.
 - Handle drives on surfaces covered with at least 2.54 cm (1 inch) of shock-proof foam.
 - Avoid dropping drives from any height onto any surface.
 - After removing a hard drive or an optical drive, place it in a static-proof bag.
 - Avoid exposing an internal hard drive to products that have magnetic fields, such as monitors or speakers.
 - Avoid exposing a drive to temperature extremes or liquids.
 - If a drive must be mailed, place the drive in a bubble pack mailer or other suitable form of protective packaging, and label the package “FRAGILE.”
-

Electrostatic discharge information

A sudden discharge of static electricity from your finger or other conductor can destroy static-sensitive devices or microcircuitry. Often the spark is neither felt nor heard, but damage occurs. An electronic device exposed to electrostatic discharge (ESD) might not appear to be affected at all and can work perfectly throughout a normal cycle. The device might function normally for a while, but it has been degraded in the internal layers, reducing its life expectancy.

Networks built into many integrated circuits provide some protection, but in many cases, the discharge contains enough power to alter device parameters or melt silicon junctions.

 **IMPORTANT:** To prevent damage to the device when you remove or install internal components, observe these precautions:

- Keep components in their electrostatic-safe containers until you are ready to install them.
 - Before touching an electronic component, discharge static electricity by using the guidelines described in [Personal grounding methods and equipment on page 21](#).
 - Avoid touching pins, leads, and circuitry. Handle electronic components as little as possible.
 - If you remove a component, place it in an electrostatic-safe container.
-

Generating static electricity

Follow these static electricity guidelines:

- Different activities generate different amounts of static electricity.
- Static electricity increases as humidity decreases.

Table 4-1 Static electricity occurrence based on activity and humidity

Event	Relative humidity		
	55%	40%	10%
Walking across carpet	7,500 V	15,000 V	35,000 V
Walking across vinyl floor	3,000 V	5,000 V	12,000 V
Motions of bench worker	400 V	800 V	6,000 V
Removing DIPs (dual in-line packages) from plastic tube	400 V	700 V	2,000 V
Removing DIPs from vinyl tray	2,000 V	4,000 V	11,500 V
Removing DIPs from polystyrene foam	3,500 V	5,000 V	14,500 V
Removing bubble pack from PCB (printed circuit board)	7,000 V	20,000 V	26,500 V
Packing PCBs in foam-lined box	5,000 V	11,000 V	21,000 V
Multiple electric components can be packaged together in plastic tubes, trays, or polystyrene foam.			

 **NOTE:** As little as 700 V of static electricity can degrade a product.

Preventing electrostatic damage to equipment

Many electronic components are sensitive to ESD. Circuitry design and structure determine the degree of sensitivity.

The following packaging and grounding precautions are necessary to prevent static electricity damage to electronic components:

- To avoid hand contact, transport products in static-safe containers such as tubes, bags, or boxes.
- Protect all electrostatic parts and assemblies with conductive or approved containers or packaging.
- Keep electrostatic-sensitive parts in their containers until they arrive at static-free stations.
- Place items on a grounded surface before removing them from their container.
- Always be properly grounded when touching a sensitive component or assembly.
- Avoid contact with pins, leads, or circuitry.
- Place reusable electrostatic-sensitive parts from assemblies in protective packaging or conductive foam.

Personal grounding methods and equipment

Using certain equipment can prevent static electricity damage to electronic components.

- **Wrist straps** are flexible straps with a maximum of $1\text{ M}\Omega \pm 10\%$ resistance in the ground cords. To provide proper ground, a strap must be worn snug against bare skin. The ground cord must be connected and fit snugly into the banana plug connector on the grounding mat or workstation.
- You can use **heel straps, toe straps, and boot straps** at standing workstations. These straps are compatible with most types of shoes or boots. On conductive floors or dissipative floor mats, use them on both feet with a maximum of $1\text{ M}\Omega \pm 10\%$ resistance between the operator and ground.

Table 4-2 Static shielding protection levels

Static shielding protection levels	
Method	Voltage
Antistatic plastic	1,500
Carbon-loaded plastic	7,500
Metallized laminate	15,000

Grounding the work area

To prevent static damage at the work area, follow these precautions:

- Cover the work surface with approved static-dissipative material.
- Use a wrist strap connected to a properly grounded work surface and use properly grounded tools and equipment.
- Use static-dissipative mats, foot straps, or air ionizers to give added protection.
- Handle electrostatic sensitive components, parts, and assemblies by the case or PCB laminate. Handle them only at static-free work areas.
- Turn off power and input signals before inserting and removing connectors or test equipment.
- Use fixtures made of static-safe materials when fixtures must directly contact dissipative surfaces.
- Keep the work area free of nonconductive materials, such as ordinary plastic assembly aids and polystyrene foam.
- Use conductive field service tools, such as cutters, screwdrivers, and vacuums.
- Avoid contact with pins, leads, or circuitry.

Recommended materials and equipment

HP recommends certain materials and equipment to prevent static electricity:

- Antistatic tape
- Antistatic smocks, aprons, or sleeve protectors
- Conductive bins and other assembly or soldering aids
- Conductive foam
- Conductive tabletop workstations with ground cord of $1\text{ M}\Omega \pm 10\%$ resistance
- Static-dissipative table or floor mats with hard tie to ground
- Field service kits
- Static awareness labels
- Wrist straps and footwear straps providing $1\text{ M}\Omega \pm 10\%$ resistance

- Material handling packages
- Conductive plastic bags
- Conductive plastic tubes
- Conductive tote boxes
- Opaque shielding bags
- Transparent metallized shielding bags
- Transparent shielding tubes

Cleaning your computer

Cleaning your computer regularly removes dirt and debris so that your device continues to operate at its best. Use the following information to safely clean the external surfaces of your computer.

Enabling HP Easy Clean (select products only)

HP Easy Clean helps you to avoid accidental input while you clean the computer surfaces. This software disables devices such as the keyboard, touch screen, and touchpad for a preset amount of time so that you can clean all computer surfaces.

1. Start HP Easy Clean in one of the following ways:
 - Select the **Start** menu, and then select **HP Easy Clean**.
– or –
 - Select the **HP Easy Clean** icon in the taskbar.
– or –
 - Select **Start**, and then select the **HP Easy Clean** tile.
2. Now that your device is disabled for a short period, see [Removing dirt and debris from your computer on page 23](#) for the recommended steps to clean the high-touch, external surfaces on your computer. After you remove the dirt and debris, you can also clean the surfaces with a disinfectant. See [Cleaning your computer with a disinfectant on page 24](#) for guidelines to help prevent the spread of harmful bacteria and viruses.

Removing dirt and debris from your computer

Here are the recommended steps to clean dirt and debris from your computer.

For computers with wood veneer, see [Caring for wood veneer \(select products only\) on page 25](#).

1. Wear disposable gloves made of latex (or nitrile gloves, if you are latex-sensitive) when cleaning the surfaces.
2. Turn off your device and unplug the power cord and other connected external devices. Remove any installed batteries from items such as wireless keyboards.

 **CAUTION:** To prevent electric shock or damage to components, never clean a product while it is turned on or plugged in.

3. Moisten a microfiber cloth with water. The cloth should be moist, but not dripping wet.

 **IMPORTANT:** To avoid damaging the surface, avoid abrasive cloths, towels, and paper towels.

4. Wipe the exterior of the product gently with the moistened cloth.

 **IMPORTANT:** Keep liquids away from the product. Avoid getting moisture in any openings. If liquid makes its way inside your HP product, it can cause damage to the product. Do not spray liquids directly on the product. Do not use aerosol sprays, solvents, abrasives, or cleaners containing hydrogen peroxide or bleach that might damage the finish.

5. Start with the display (if applicable). Wipe carefully in one direction, and move from the top of the display to the bottom. Finish with any flexible cables, like power cord, keyboard cable, and USB cables.
6. Be sure that surfaces have completely air-dried before turning the device on after cleaning.
7. Discard the gloves after each cleaning. Clean your hands immediately after you remove the gloves.

See [Cleaning your computer with a disinfectant on page 24](#) for recommended steps to clean the high-touch, external surfaces on your computer to help prevent the spread of harmful bacteria and viruses.

Cleaning your computer with a disinfectant

The World Health Organization (WHO) recommends cleaning surfaces, followed by disinfection, as a best practice for preventing the spread of viral respiratory illnesses and harmful bacteria.

After cleaning the external surfaces of your computer using the steps in [Removing dirt and debris from your computer on page 23](#), [Caring for wood veneer \(select products only\) on page 25](#), or both, you might also choose to clean the surfaces with a disinfectant. A disinfectant that is within HP's cleaning guidelines is an alcohol solution consisting of 70% isopropyl alcohol and 30% water. This solution is also known as rubbing alcohol and is sold in most stores.

Follow these steps when disinfecting high-touch, external surfaces on your computer:

1. Wear disposable gloves made of latex (or nitrile gloves, if you are latex-sensitive) when cleaning the surfaces.
2. Turn off your device and unplug the power cord and other connected external devices. Remove any installed batteries from items such as wireless keyboards.

 **CAUTION:** To prevent electric shock or damage to components, never clean a product while it is turned on or plugged in.

3. Moisten a microfiber cloth with a mixture of 70% isopropyl alcohol and 30% water. The cloth should be moist, but not dripping wet.

 **CAUTION:** Do not use any of the following chemicals or any solutions that contain them, including spray-based surface cleaners: bleach, peroxides (including hydrogen peroxide), acetone, ammonia, ethyl alcohol, methylene chloride, or any petroleum-based materials, such as gasoline, paint thinner, benzene, or toluene.

 **IMPORTANT:** To avoid damaging the surface, avoid abrasive cloths, towels, and paper towels.

4. Wipe the exterior of the product gently with the moistened cloth.

 **IMPORTANT:** Keep liquids away from the product. Avoid getting moisture in any openings. If liquid makes its way inside your HP product, it can cause damage to the product. Do not spray liquids directly

on the product. Do not use aerosol sprays, solvents, abrasives, or cleaners containing hydrogen peroxide or bleach that might damage the finish.

5. Start with the display (if applicable). Wipe carefully in one direction, and move from the top of the display to the bottom. Finish with any flexible cables, like power cord, keyboard cable, and USB cables.
6. Be sure that surfaces have completely air-dried before turning the device on after cleaning.
7. Discard the gloves after each cleaning. Clean your hands immediately after you remove the gloves.

Caring for wood veneer (select products only)

Your product might feature high-quality wood veneer. As with all natural wood products, proper care is important for best results over the life of the product. Because of the nature of natural wood, you might see unique variations in the grain pattern or subtle variations in color, which are normal.

- Clean the wood with a dry, static-free microfiber cloth or chamois.
- Avoid cleaning products containing substances such as ammonia, methylene chloride, acetone, turpentine, or other petroleum-based solvents.
- Do not expose the wood to sun or moisture for long periods of time.
- If the wood becomes wet, dry it by dabbing with an absorbent, lint-free cloth.
- Avoid contact with any substance that might dye or discolor the wood.
- Avoid contact with sharp objects or rough surfaces that might scratch the wood.

See [Removing dirt and debris from your computer on page 23](#) for the recommended steps to clean the high-touch, external surfaces on your computer. After you remove the dirt and debris, you can also clean the surfaces with a disinfectant. See [Cleaning your computer with a disinfectant on page 24](#) for sanitizing guidelines to help prevent the spread of harmful bacteria and viruses.

Packaging and transporting guidelines

Follow these grounding guidelines when packaging and transporting equipment:

- To avoid hand contact, transport products in static-safe tubes, bags, or boxes.
- Protect ESD-sensitive parts and assemblies with conductive or approved containers or packaging.
- Keep ESD-sensitive parts in their containers until the parts arrive at static-free workstations.
- Place items on a grounded surface before removing items from their containers.
- Always be properly grounded when touching a component or assembly.
- Store reusable ESD-sensitive parts from assemblies in protective packaging or nonconductive foam.
- Use transporters and conveyors made of antistatic belts and roller bushings. Be sure that mechanized equipment used for moving materials is wired to ground and that proper materials are selected to avoid static charging. When grounding is not possible, use an ionizer to dissipate electric charges.

Accessing support information

To find the HP support that you need, use this information.

Table 4-3 Support information locations



Service consideration	Path to access information
Records of reported failure incidents stored on the computer	<p>Windows:</p> <p>Pre-operating system failures are logged in the BIOS Event Log. To view the BIOS Event Log:</p> <ol style="list-style-type: none">1. Press the power button.2. Immediately and repeatedly press esc when the power button light turns white. <p>NOTE: If you do not press esc at the appropriate time, you must restart the computer and again repeatedly press esc when the power button light turns white to access the utility.</p> <ol style="list-style-type: none">3. Press f10 to enter the BIOS setup.4. (On commercial products) Under the Main tab, select BIOS event log, and then select View BIOS Event Log. <p>- or -</p> <p>(On consumer products) Under the Main tab, select System Log.</p> <p>Post-operating system failures are logged in the Event Viewer.</p> <ol style="list-style-type: none">1. Turn on the computer and allow the operating system to open.2. Select the search icon  in the taskbar.3. Type <code>Event Viewer</code>, and then press enter.4. Select the log from the left panel. Details display in the right panel. <p>Chrome:</p> <ol style="list-style-type: none">1. Go to support.google.com/chrome.2. Search <code>collect Chrome device logs</code>.
Technical bulletins	<p>To locate technical bulletins:</p> <ol style="list-style-type: none">1. Go to www.hp.com.2. Place the cursor over Problem solving to display more options.3. Select Support & Troubleshooting.4. Type the serial number, product number, or product name to go to the product support page.5. Select Advisories to view technical bulletins.
Repair professionals	<p>To locate repair professionals:</p> <ol style="list-style-type: none">1. Go to www.hp.com.2. Place the cursor over Support resources to display more options.3. Select Authorized service providers.
Component and diagnosis information, failure detection, and required action	<p>To locate diagnosis information and actions:</p> <ol style="list-style-type: none">1. Go to http://www.hp.com/go/techcenter/pcdiags.2. Select Get Support.

Table 4-3 Support information locations (continued)

Service consideration	Path to access information
	3. Near the bottom of the window, select Notebook PCs , and then select your location.

5 Removal and replacement procedures for authorized service provider parts

This chapter provides removal and replacement procedures for authorized service provider parts.

 **IMPORTANT:** Only an authorized service provider should access the components described in this chapter. Accessing these parts can damage the computer or void the warranty.

 **NOTE:** Details about your computer, including model, serial number, product key, and length of warranty, are on the service tag at the bottom of your computer.

Component replacement procedures

To remove and replace computer components, use the procedures described in this section.

 **NOTE:** HP continually improves and changes product parts. For complete and current information about supported parts for your computer, go to <http://partsurfer.hp.com>, select your country or region, and then follow the on-screen instructions.

Make special note of each screw size and location during removal and replacement.

Preparation for disassembly

To remove and replace computer components, use these procedures:

For initial safety procedures, see [Removal and replacement procedures preliminary requirements on page 19](#).

1. Turn off the computer. If you are unsure whether the computer is off or in Hibernation, turn the computer on, and then shut it down through the operating system.
2. Disconnect the power from the computer by unplugging the power cord from the computer.
3. Disconnect all external devices from the computer.

Bottom cover

To remove the bottom cover, use this procedure and illustration.

Table 5-1 Bottom cover description and part number

Description	Spare part number
Bottom cover	N14831-001

Before removing the bottom cover, prepare the computer for disassembly (see [Preparation for disassembly on page 28](#)).

Remove the bottom cover:

1. Remove the nine captive Phillips screws (1) that secure the bottom cover to the computer.

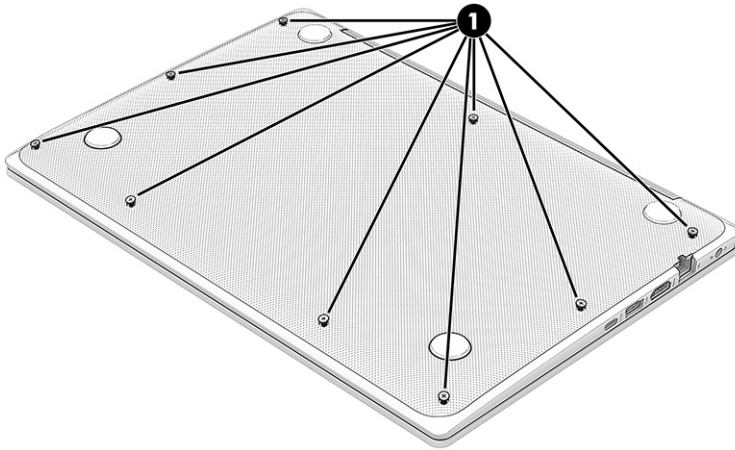

2. Starting near the hinges, use a nonmarking, nonconductive tool to release the edges of the cover from the computer.

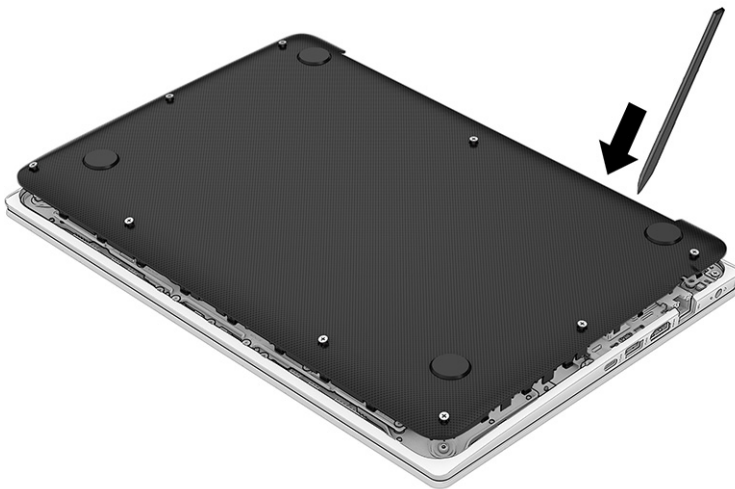

To replace the bottom cover, reverse the removal procedures.

Battery

To remove the battery, use this procedure and illustration.

Table 5-2 Battery description and part number

Description	Spare part number
Battery, 3 cell, 42 Whr	M73474-005

⚠ WARNING! To avoid personal injury and damage to the product:

- Do *not* puncture, twist, or crack the battery.

- Do *not* cause an external puncture or rupture to the battery. They can cause a short inside the battery, which can result in battery thermal runaway.
- Do *not* handle or touch the battery enclosure with sharp objects such as tweezers or pliers, which might puncture the battery.
- Do *not* compress or squeeze the battery case with tools or heavy objects stacked on top of the case. These actions can apply undue force on the battery.
- Do *not* touch the connectors with any metallic surface or object, such as metal tools, screws, or coins, which can cause shorting across the connectors.

Before removing the battery, follow these steps:

1. Prepare the computer for disassembly (see [Preparation for disassembly on page 28](#)).
2. Remove the bottom cover (see [Bottom cover on page 28](#)).

⚠ WARNING! To reduce potential safety issues, use only the user-replaceable battery provided with the computer, a replacement battery provided by HP, or a compatible battery purchased from HP.

📄 IMPORTANT: Removing a battery that is the sole power source for the computer can cause loss of information. To prevent loss of information, save your work or shut down the computer through Windows before you remove the battery.

Remove the battery:

1. Disconnect the battery cable from the system board (1).
2. Remove the seven Phillips M2.0 × 4.0 screws (2) that secure the battery to the computer.
3. Remove the battery from the computer (3).

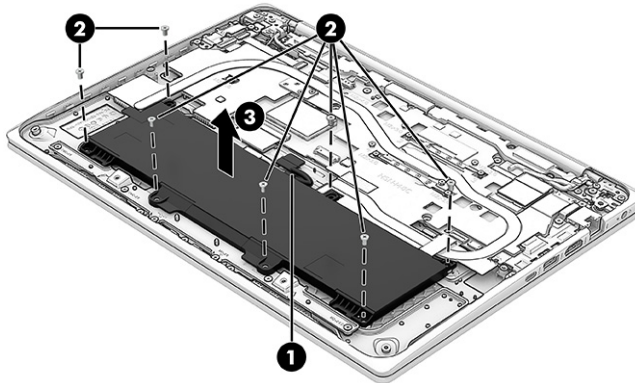

To install the battery, reverse the removal procedures.

WLAN module

To remove the WLAN module, use this procedure and illustration.

Table 5-3 WLAN module descriptions and part numbers

Description	Spare part number
Intel 9560 802.11b/g/n/a/ac (2 × 2) and Bluetooth 5	L22634-002
Intel AX211 Wi-Fi 6e Bluetooth 5.2 WLAN	M53366-002

 **IMPORTANT:** To prevent an unresponsive system, replace the wireless module only with a wireless module authorized for use in the computer by the governmental agency that regulates wireless devices in your country or region. If you replace the module and then receive a warning message, remove the module to restore device functionality, and then contact technical support.

Before removing the WLAN module, follow these steps:

1. Prepare the computer for disassembly (see [Preparation for disassembly on page 28](#)).
2. Remove the bottom cover (see [Bottom cover on page 28](#)).
3. Disconnect the battery cable from the system board (see [Battery on page 29](#)).

Remove the WLAN module:

1. Remove the plastic that covers the antennas (1).
2. Carefully disconnect the two antenna cables from the module (2).
3. Remove the Phillips M2.0 × 2.5 screw (3), and then remove the WLAN module (4).

 **NOTE:** Models have either one or two WLAN antennas. On models with two antennas, the #1 white WLAN antenna cable connects to the WLAN module #1 Main terminal. The #2 black WLAN antenna cable connects to the WLAN module #1 Aux terminal.

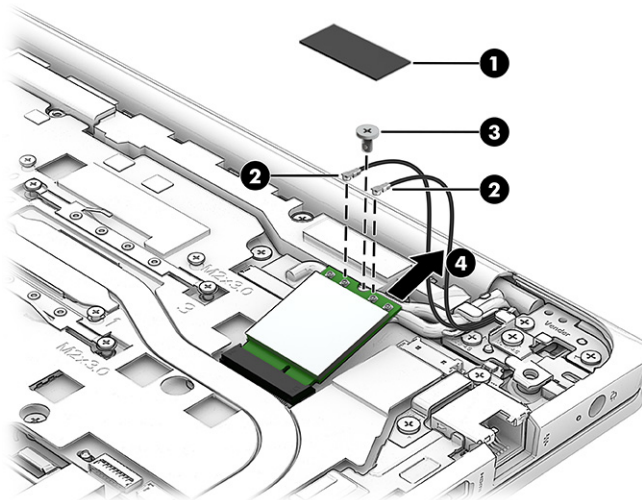

4. If the WLAN antenna is not connected to the terminal on the WLAN module, install a protective sleeve on the antenna connector, as shown in the following illustration.

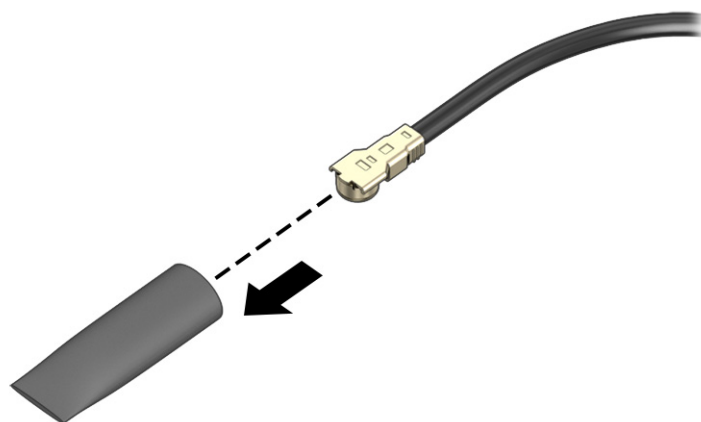

To install the WLAN module, reverse this procedure.

Solid-state drive

To remove the M.2 solid-state drive, use this procedure and illustration.

Table 5-4 Solid-state drive descriptions and part numbers

Description	Spare part number
256 GB, PCIe	M11042-002
128 GB, PCIe	M11040-002
Solid-state drive cover (in Bracket Kit)	N07102-001

Before removing the solid-state drive, follow these steps:

1. Prepare the computer for disassembly (see [Preparation for disassembly on page 28](#)).
2. Remove the bottom cover (see [Bottom cover on page 28](#)).
3. Disconnect the battery cable from the system board (see [Battery on page 29](#)).

Remove the solid-state drive:

1. Remove the Phillips M2.0 × 2.5 screw **(1)** that secures the drive to the computer.

2. Pull the drive away from the socket to remove it (2).

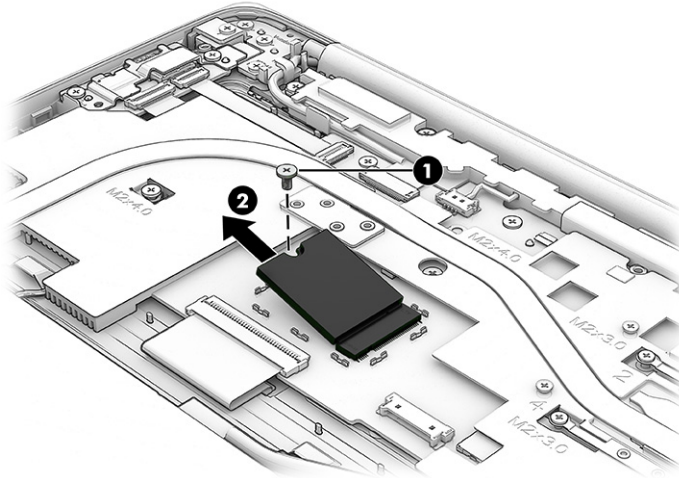

To install the solid-state drive, reverse the removal procedures.

 **NOTE:** Solid-state drives are designed with a notch to prevent incorrect insertion.

RTC battery

To remove the RTC battery, use this procedure and illustration.

Table 5-5 RTC battery description and part number

Description	Spare part number
RTC battery	L43797-001

Before removing the RTC battery, follow these steps:

1. Prepare the computer for disassembly (see [Preparation for disassembly on page 28](#)).
2. Remove the bottom cover (see [Bottom cover on page 28](#)).
3. Remove the battery (see [Battery on page 29](#)).

Remove the RTC battery:

1. Disconnect the battery cable from the system board (1).
2. Remove the tape that secures the cable to the computer (2).

3. Use a tool to release the battery from the computer (3).

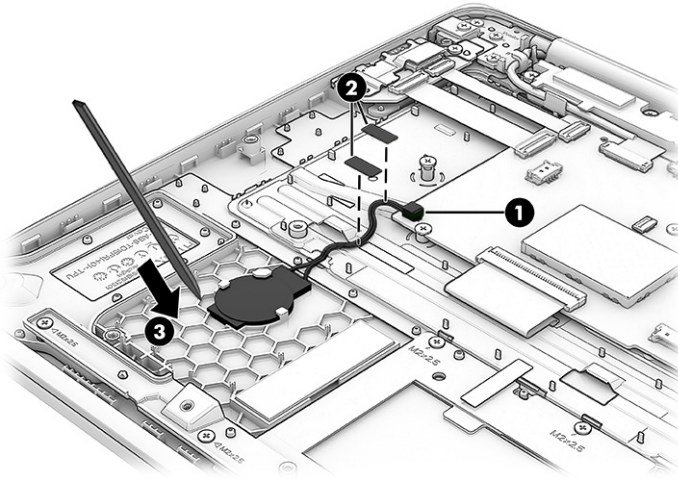

To install the RTC battery, reverse this procedure.

USB/audio board

To remove the USB/audio board, use this procedure and illustration.

Table 5-6 USB/audio board description and part number

Description	Spare part number
USB/audio board	N07103-001
USB/audio board cable (included in Cable Kit)	N20852-001
USB/audio board bracket (in Bracket Kit)	N07102-001

Before removing the USB/audio board, follow these steps:

1. Prepare the computer for disassembly (see [Preparation for disassembly on page 28](#)).
2. Remove the bottom cover (see [Bottom cover on page 28](#)).
3. Disconnect the battery cable from the system board (see [Battery on page 29](#)).

Remove the USB/audio board:

1. Disconnect the two cables from the ZIF connectors on the USB/audio board (1).
2. Remove the two Phillips M2.0 × 4.0 screws (2) that secure the board to the computer, and then remove the bracket from the board (3).

3. Lift the back of the board up, and then pull it into the computer to remove it (4).

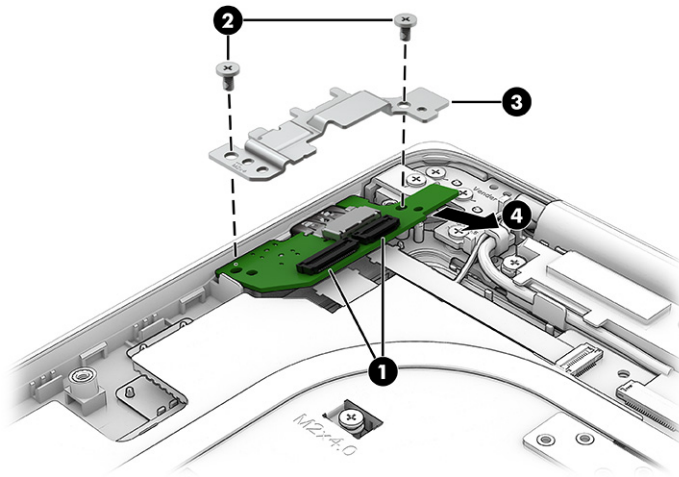

To install the USB/audio board, reverse this procedure.

Speaker

To remove the speaker, use this procedure and illustration.

Table 5-7 Speaker description and part number

Description	Spare part number
Speaker	N07104-001

Before removing the speaker, follow these steps:

1. Prepare the computer for disassembly (see [Preparation for disassembly on page 28](#)).
2. Remove the bottom cover (see [Bottom cover on page 28](#)).
3. Disconnect the battery cable from the system board (see [Battery on page 29](#)).

Remove the speaker:

1. Disconnect the speaker cable from the system board (1).
2. Remove display cable from the clip on the left side of the speaker (2).
3. Remove the four Phillips M2.0 × 6.0 screws from the speaker (3).

4. Remove the speaker from the computer (4).

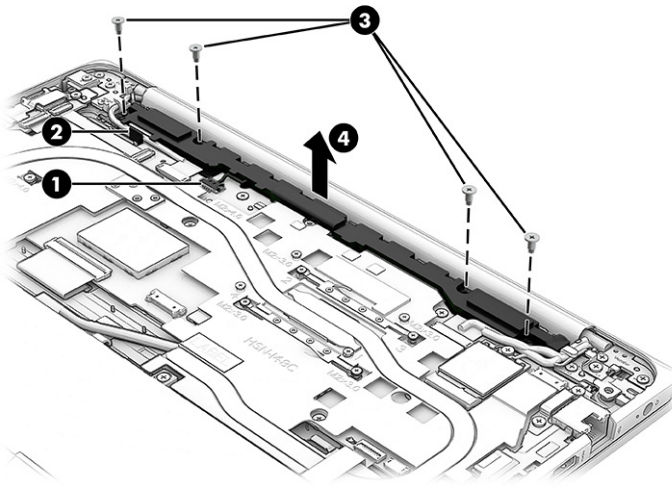

To install the speakers, reverse this procedure.

Touchpad

To remove the touchpad, use this procedure and illustration.

Table 5-8 Touchpad description and part number

Description	Spare part number
Touchpad	N00689-001
Touchpad cable (in Cable Kit)	N20852-001

Before removing the touchpad, follow these steps:

1. Prepare the computer for disassembly (see [Preparation for disassembly on page 28](#)).
2. Remove the bottom cover (see [Bottom cover on page 28](#)).
3. Remove the battery (see [Battery on page 29](#)).

Remove the touchpad:

1. Remove the six Phillips M2.0 × 2.5 screws (1) that secure the touchpad bracket to the computer.

2. Remove the bracket (2).

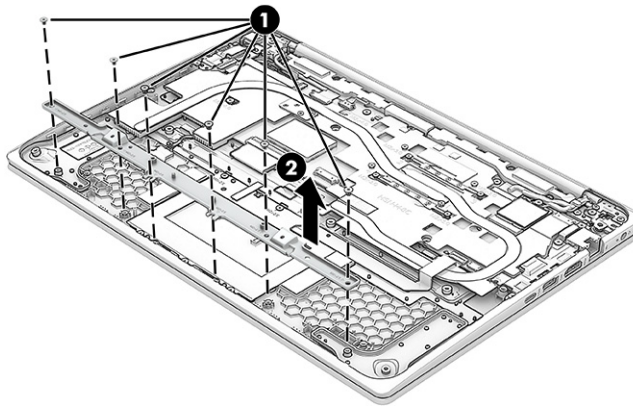

3. Disconnect the cable from the ZIF connector on the touchpad (1).
4. Lift the cable off the screw at the upper-right of the touchpad (2).
5. Peel the grounding tape off the touchpad (3).
6. Remove the six Phillips M2.0 × 2.5 screws (4) that secure the touchpad to the computer.
7. Remove the touchpad from the computer (5).

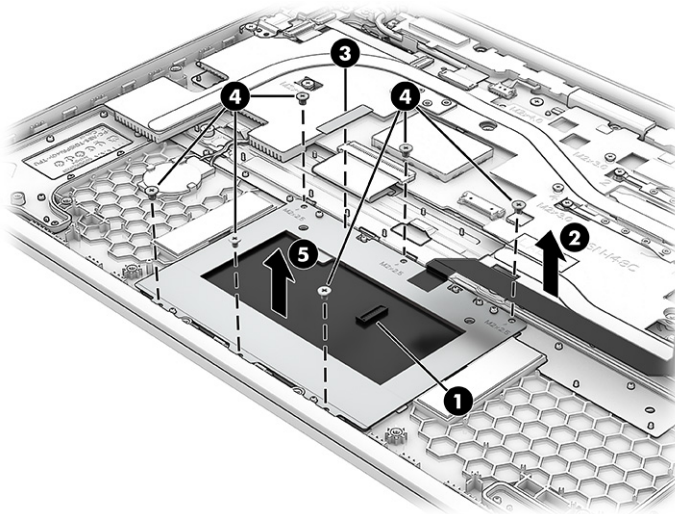

To install the touchpad, reverse this procedure.

Heat sink

To remove the heat sink, use these procedures and illustrations.

Table 5-9 Heat sink descriptions and part numbers

Description	Spare part number
Heat sink	N20164-001
Heat sink thermal grease	M86388-001

Before removing the heat sink, follow these steps:

1. Prepare the computer for disassembly (see [Preparation for disassembly on page 28](#)).
2. Remove the bottom cover (see [Bottom cover on page 28](#)).
3. Disconnect the battery cable from the system board (see [Battery on page 29](#)).

Remove the heat sink:

1. Remove the four Phillips M2.0 × 4.0 screws (1) that secure the USB bracket to the computer, and then remove the bracket (2).

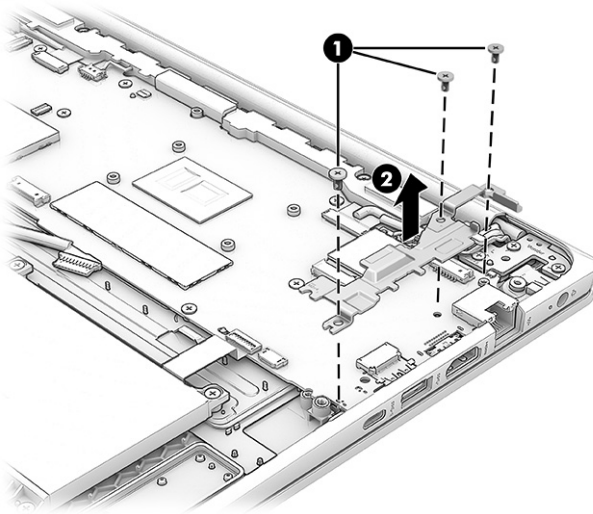

2. Remove the four Phillips M2.0 × 3.0 screws (1) from the middle of the heat sink.
3. Remove the Phillips M2.0 × 3.0 screw (2) from the left side of the heat sink.
4. Lift the top of the heat sink up to about 30°, and then pull the heat sink toward the top of the computer so that it slides out from under the USB bracket on the right side of the computer (3).

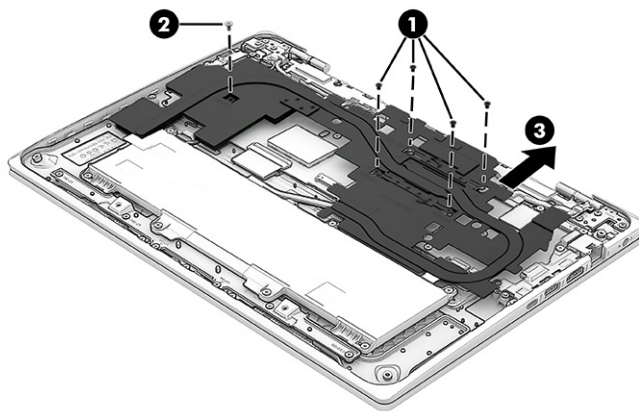

5. Thoroughly clean the thermal material from the surfaces of the heat sink and the system board components each time the heat sink is removed. Replacement thermal material is included with the

heat sink and system board spare part kits. The following illustration shows the replacement thermal material locations.

Thermal paste is used on the heat sink **(1)** and system board component **(2)** as shown in the following illustration.

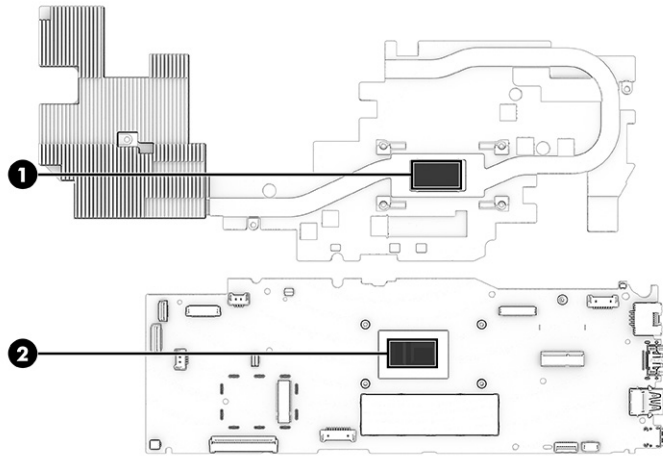

To install the heat sink, reverse this procedure.

Power connector cable

To remove the power connector cable, use this procedure and illustration.

Table 5-10 Power connector cable description and part number

Description	Spare part number
Power connector cable	N02674-001
Power connector bracket (in Bracket Kit)	N07102-001

Before removing the power connector cable, follow these steps:

1. Prepare the computer for disassembly (see [Preparation for disassembly on page 28](#)).
2. Remove the bottom cover (see [Bottom cover on page 28](#)).
3. Disconnect the battery cable from the system board (see [Battery on page 29](#)).

Remove the power connector cable:

1. Disconnect the cable from the system board **(1)**.
2. Remove the Phillips M2.0 × 4.0 screw **(2)** that secures the power connector cable to the computer.

3. Remove the power connector cable from the computer (3).

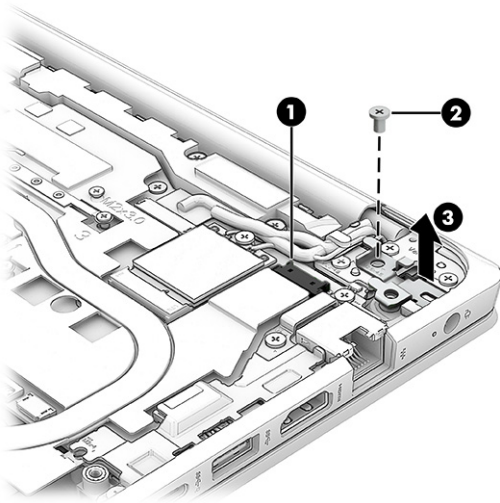

To install the power connector cable, reverse this procedure.

System board

To remove the system board, use these procedures and illustrations.

Table 5-11 System board descriptions and part numbers

Description	Spare part number
System board (includes processor):	
All system boards use the following part numbers:	
xxxxxx-001: Non-Windows operating system	
xxxxxx-601: Windows operating system	
Intel Core i5-1230U processor and 8 GB of system memory	N15444-xx1
Intel Core i3-1210U processor and 8 GB of system memory	N15443-xx1
Intel Core i3-1210U processor and 4 GB of system memory	N15442-xx1

Before removing the system board, follow these steps:

1. Prepare the computer for disassembly (see [Preparation for disassembly on page 28](#)).
2. Remove the bottom cover (see [Bottom cover on page 28](#)).
3. Disconnect the battery cable from the system board (see [Battery on page 29](#)).

When you replace the system board, be sure to remove the following components from the defective system board and install them on the replacement system board:

- WLAN module (see [WLAN module on page 30](#))
- Solid-state drive (see [Solid-state drive on page 32](#))

- Heat sink (see [Heat sink on page 37](#))

Remove the system board:

1. Disconnect the following cables from the system board:

- USB/audio board cable (ZIF) (1)
- Display cable (ZIF) (2)
- Speaker cable (3)
- Power connector cable (4)
- Touchpad cable (ZIF) (5)
- Keyboard cable (reverse ZIF) (6)
- RTC battery cable (7)

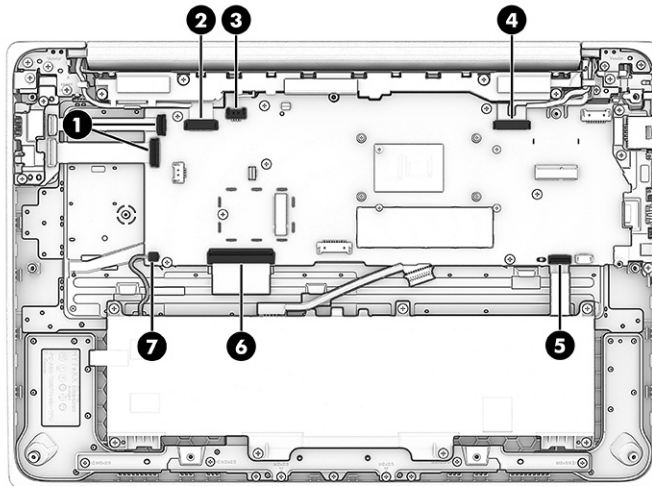

2. Remove the five Phillips M2.0 × 4.0 screws (1) that secure the system board and USB bracket to the computer. Four screws secure the USB bracket.
3. Remove the USB bracket (2).
4. Remove the six Phillips M2.5 × 3.0 screws (3) that secure the system board to the computer.

5. Lift the left side of the system board up, and then pull the board to the left to remove it from the computer (4).

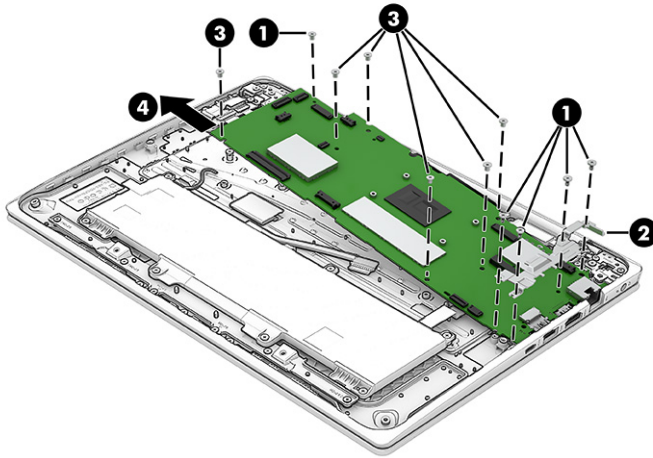

To install the system board, reverse this procedure.

Display assembly

To remove and disassemble the display assembly, use these procedures and illustrations.

Before removing the display panel, follow these steps:

1. Prepare the computer for disassembly (see [Preparation for disassembly on page 28](#)).
2. Remove the bottom cover (see [Bottom cover on page 28](#)).
3. Disconnect the battery cable from the system board (see [Battery on page 29](#)).

Remove the display assembly:

1. Disconnect the following cables from the system board:
 - (1) WLAN antennas
 - (2) Camera cable
 - (3) Display cable

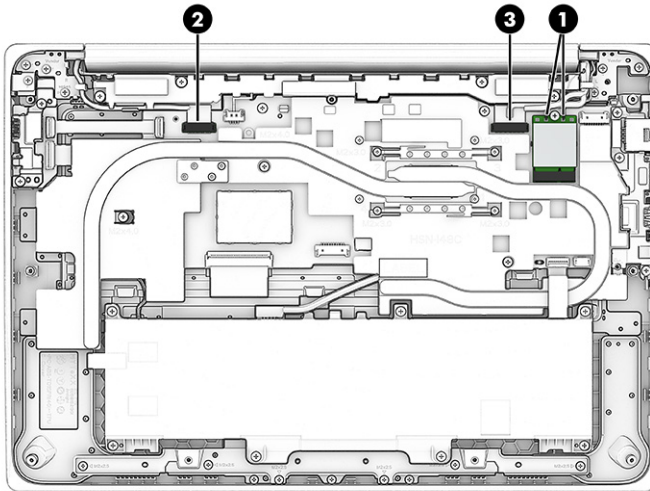

2. Remove the seven Phillips M2.5 × 5.0 screws (1) that secure the display assembly to the computer.
3. Open the computer (2), and separate it from the display (3).

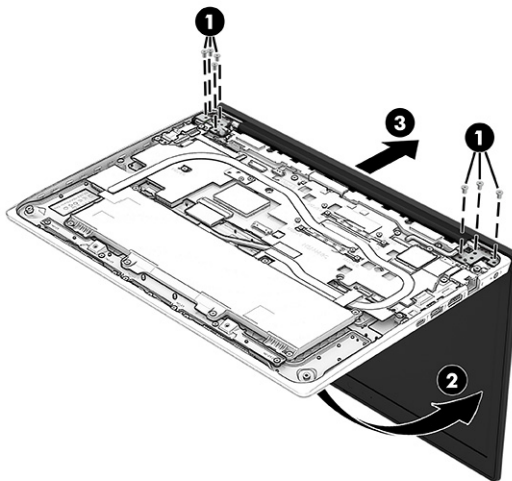

4. Slide the hinge cover to the right, and then remove it from the display.

 **NOTE:** When installing the hinge cover, align the cover with the marks, press onto the bezel, and then slide the cover left until it clicks into place.

The hinge cover is available in the Hinge Kit as spare part number N00687-001.

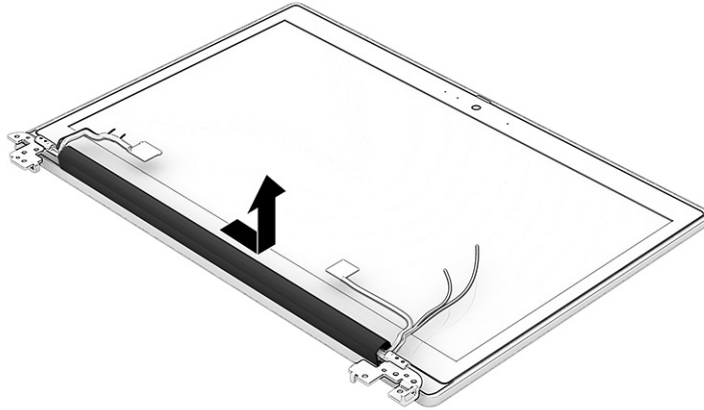

5. If you need to remove the display bezel:

- a.** Remove the two Phillips M2.0 × 4.0 screws **(1)** that secure the bezel to the display.
- b.** Insert a thin tool under the bezel and pull it around the entire bezel to release it **(2)**.
- c.** Remove the display bezel **(3)** from the display assembly.

The bezel is available as spare part number N07100-001.

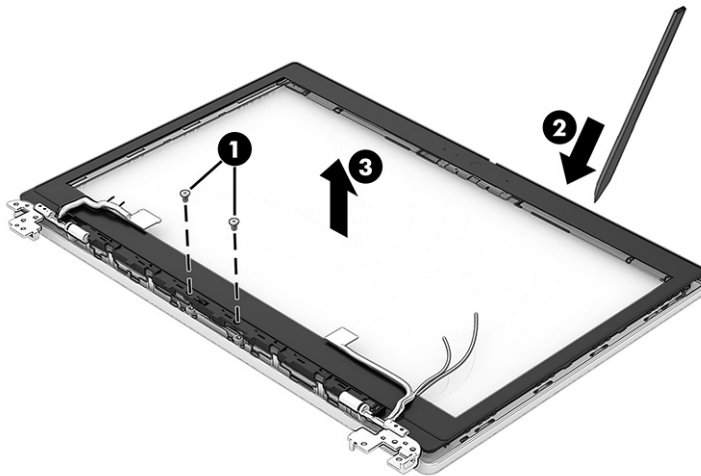

6. If you need to remove the camera module:

- ▲ Disconnect the cable from the ZIF connector on the camera module (1), and then carefully release the module from the display (2). (The module is attached with double-sided adhesive.) The camera module is available as spare part number N07105-001.

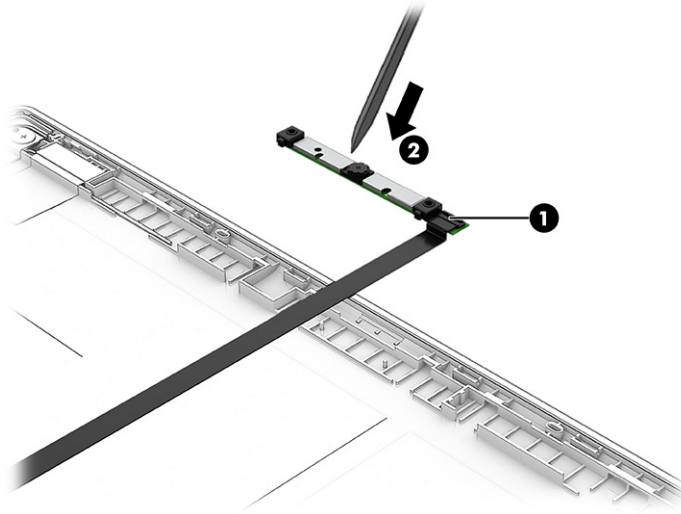

7. If you need to remove the display panel:

 **NOTE:** The display panel comes with the hinge brackets installed. The brackets are secured to the panel using adhesive pull tape.

- a. Remove the four Phillips M2.5 × 2.5 screws (1) from each hinge.

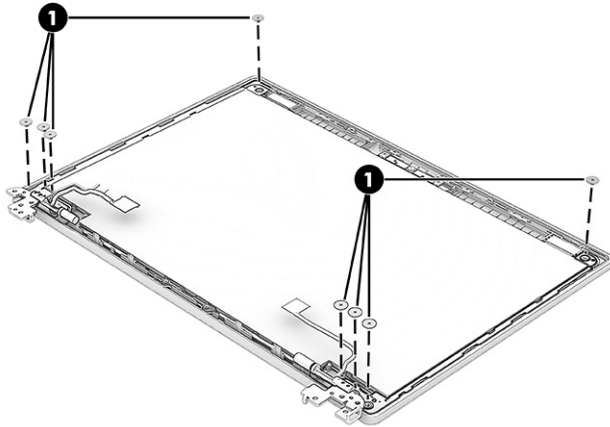

- b. The display panel is secured to the display rear cover with tape that is installed under the panel. First, remove the tape of the left and right sides of the panel, and then lift the bottom of the panel up to access and remove more tape.

To remove the panel, use tweezers to grasp the end of the tape on the left and right sides of the panel (1). While turning the tweezers, wrap the tape around the tweezers (2) as you continue to pull the tape out from behind the display panel. You must pull the tape multiple times before it is completely removed.

- c. Lift the panel off the display assembly and place it next to the display (3).

 **NOTE:** You have to pull on the tape multiple times before it is completely removed.

Display panels are available as the following spare part numbers:

N08932-001: FHD, antiglare, UWVA, nontouch

N08933-001: FHD, antiglare, UWVA, Touch-on panel (TOP)

N08935-001: HD, antiglare, SVA, nontouch

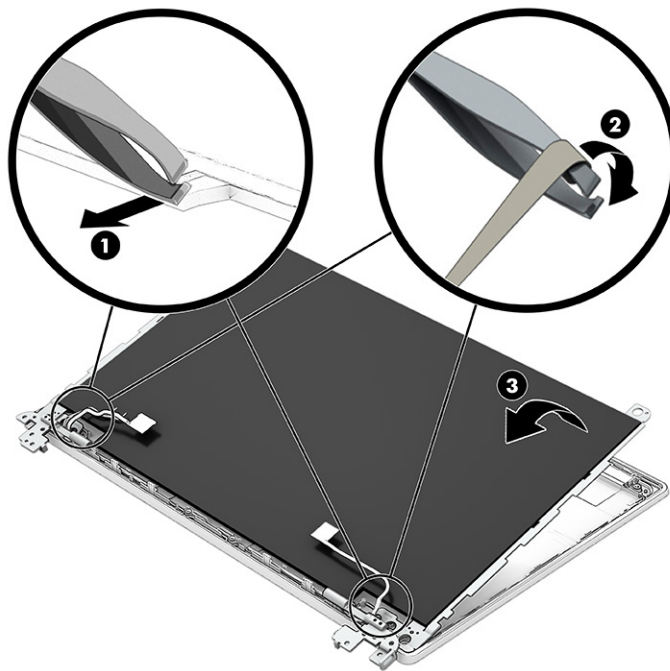

- d. If you need to remove the display cable, peel the tape off the connector on the back of the panel (1), disconnect the cable from the panel (2), and then remove the cable from the left hinge and clips in the display rear cover (3). The display cable is available as spare part number N07110-001.

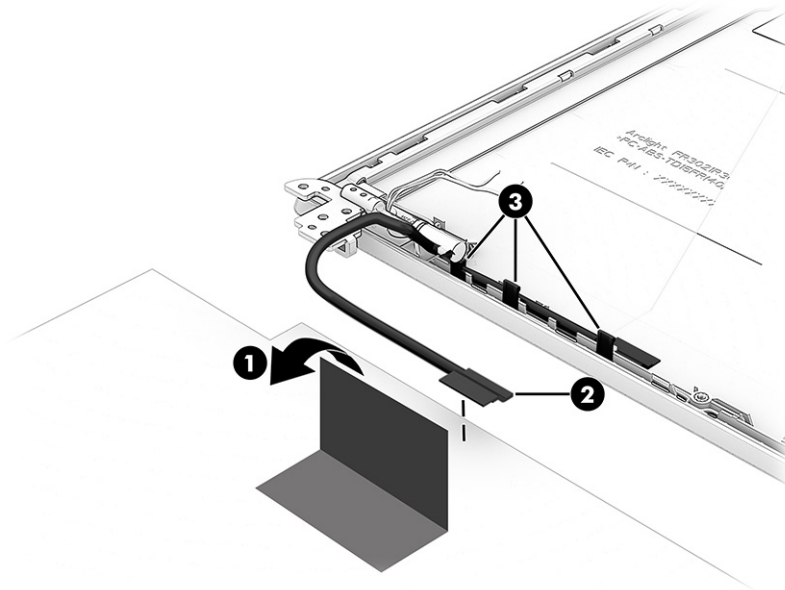

- e. When installing a display panel, use the following illustration to determine proper display panel adhesive installation locations along the entire length of both hinge brackets.



NOTE: Replacement display panels come with the bracket installed. To install the panel, screw the bracket onto the display back cover, install pull tape onto bracket, and then align the panel on the top of the display back cover with the bracket.

After installation, if the panel is misaligned or you can see tape from the assembled display near the bezel, you must disassemble and reassemble the panel to correct.

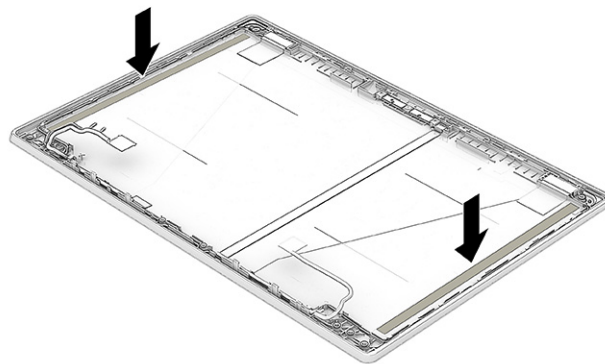

8. If you need to remove the hinges from the display rear cover:
- Remove the four Phillips M2.5 × 2.5 screws (1) from each hinge.
 - Remove the display hinges from the display rear cover (2).

The display hinges are available in the Hinge Kit as spare part number N00687-001.

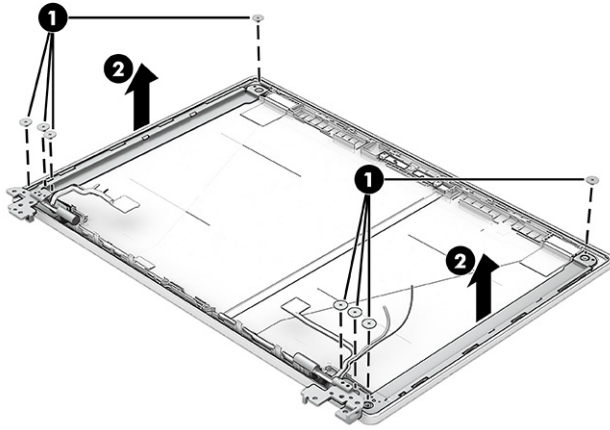

9. If you need to remove the camera cable from the display rear cover:

- a.** Disconnect the cable from the camera module (1).
- b.** Peel the cable off the inside of the display rear cover (2), and then remove the cable from the clips along the bottom of the display rear cover (3). The camera cable is available in the Cable Kit as spare part number N07101-001.

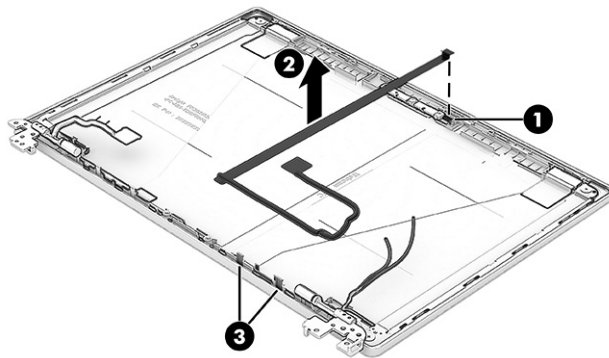

10. If you need to remove the WLAN antennas:

- a.** Remove the cables from their routing along the sides and bottom of the display rear cover (1).

- b. Peel the antennas off the top of the display rear cover (2). The WLAN antennas are available as spare part number N07099-001.

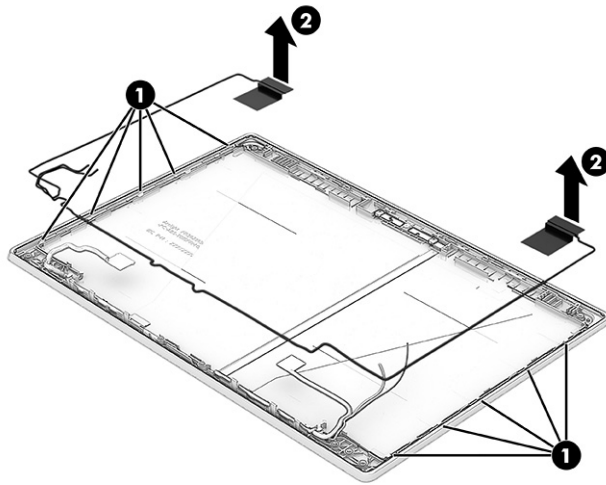

The display rear cover is available spare part numbers N00685-001.

To reassemble and replace the display assembly, reverse these procedures.

Top cover with keyboard

The top cover with keyboard remains after removing all other spare parts from the computer. In this section, the first table provides the main spare part number for the top cover/keyboard. The second table provides the country codes.

Table 5-12 Top cover with keyboard descriptions and part numbers

Description	Spare part number
Top cover with keyboard	N14832-xx1

Table 5-13 Spare part country codes

For use in country or region	Spare part number	For use in country or region	Spare part number	For use in country or region	Spare part number
Belgium	-A41	Hungary	-211	Saudi Arabia	-171
Brazil	-201	Iceland	-DD1	Slovenia	-BA1
Bulgaria	-261	India	-D61	South Korea	-AD1
Chile	-161	Israel	-BB1	Spain	-071
Czech Republic/Slovakia	-FL1	Italy	-061	Switzerland	-BG1
Denmark	-081	Japan	-291	Taiwan	-AB1
Denmark, Finland, and Norway	-DH1	The Netherlands	-B31	Thailand	-281
French Canada	-DB1	Northern Africa	-FP1	Turkey	-141
Finland/Sweden	-B71	Norway	-091	Turkey-F	-541

Table 5-13 Spare part country codes (continued)

For use in country or region	Spare part number	For use in country or region	Spare part number	For use in country or region	Spare part number
France	-051	Portugal	-131	Ukraine	-BD1
Germany	-041	Romania	-271	United Kingdom	-031
Greece	-151	Russia	-251	United States	-001

6 Computer Setup (BIOS), TPM, and HP Sure Start

HP provides several tools to help set up and protect your computer.

Using Computer Setup

Computer Setup, or Basic Input/Output System (BIOS), controls communication between all the input and output devices on the system (such as hard drives, display, keyboard, mouse, and printer). Computer Setup includes settings for types of devices installed, the startup sequence of the computer, and amount of system and extended memory.

 **NOTE:** Use extreme care when making changes in Computer Setup. Errors can prevent the computer from operating properly.

To start Computer Setup, turn on or restart the computer, and when the HP logo appears, press **f10** to enter Computer Setup.

Navigating and selecting in Computer Setup

You can navigate and select in Computer Setup using one or more methods.

- To select a menu or a menu item, use the **tab** key and the keyboard arrow keys and then press **enter**, or use a pointing device to select the item.
- To scroll up and down, select the up arrow or the down arrow in the upper-right corner of the screen, or use the up arrow key or the down arrow key on the keyboard.
- To close open dialog boxes and return to the main Computer Setup screen, press **esc**, and then follow the on-screen instructions.

To exit Computer Setup, choose one of the following methods:

- To exit Computer Setup menus without saving your changes, select **Main**, select **Ignore Changes and Exit**, and then select **Yes**.

 **NOTE:** If you are using arrow keys to highlight your choice, you must then press **enter**.

- To save your changes and exit Computer Setup menus, select **Main**, select **Save Changes and Exit**, and then select **Yes**.

 **NOTE:** If you are using arrow keys to highlight your choice, you must then press **enter**.

Your changes go into effect when the computer restarts.

Restoring factory settings in Computer Setup

To return all settings in Computer Setup to the values that were set at the factory, follow these steps.

 **NOTE:** Restoring defaults will not change the hard drive mode.

1. Start Computer Setup. See [Using Computer Setup on page 51](#).
2. Select **Main**, select **Apply Factory Defaults and Exit**, and then select **Yes**.

 **NOTE:** If you are using arrow keys to highlight your choice, you must then press **enter**.

 **NOTE:** On select products, the selections might display **Restore Defaults** instead of **Apply Factory Defaults and Exit**.

Your changes go into effect when the computer restarts.

 **NOTE:** Your password settings and security settings are not changed when you restore the factory settings.

Updating the BIOS

Updated versions of the BIOS might be available on the HP website. Most BIOS updates on the HP website are packaged in compressed files called *SoftPaqs*.

Some download packages contain a file named *Readme.txt*, which contains information regarding installing and troubleshooting the file.

Determining the BIOS version

To decide whether you need to update Computer Setup (BIOS), first determine the BIOS version on your computer.

If you are already in Windows, you can access BIOS version information (also known as *ROM date* and *System BIOS*) by pressing **fn+esc** (select products only). Or you can use Computer Setup.

1. Start Computer Setup. See [Using Computer Setup on page 51](#).
2. Select **Main**, and then select **System Information**.
3. To exit Computer Setup menus without saving your changes, select **Main**, select **Ignore Changes and Exit**, and then select **Yes**.

 **NOTE:** If you are using arrow keys to highlight your choice, you must then press **enter**.

To check for later BIOS versions, see [Preparing for a BIOS update on page 52](#).

Preparing for a BIOS update

Be sure to follow all prerequisites before downloading and installing a BIOS update.

 **IMPORTANT:** To reduce the risk of damage to the computer or an unsuccessful installation, download and install a BIOS update only when the computer is connected to reliable external power using the AC adapter. Do not download or install a BIOS update while the computer is running on battery power, docked in an optional docking device, or connected to an optional power source. During the download and installation, follow these instructions:

Do not disconnect power on the computer by unplugging the power cord from the AC outlet.

Do not shut down the computer or initiate Sleep.

Do not insert, remove, connect, or disconnect any device, cable, or cord.

Downloading a BIOS update

After you review the prerequisites, you can check for and download BIOS updates.

1. Select the **Search** icon (select products only) from the taskbar, type `support`, and then select the HP Support Assistant app.
– or –
Select the question mark icon (select products only) in the taskbar.
2. Select **Updates**, and then select **Check for updates and messages**.
3. Follow the on-screen instructions.
4. At the download area, follow these steps:
 - a. Identify the most recent BIOS update and compare it to the BIOS version currently installed on your computer. Make a note of the date, name, or other identifier. You might need this information to locate the update later, after it has been downloaded to your hard drive.
 - b. Follow the on-screen instructions to download your selection to the hard drive.

Make a note of the path to the location on your hard drive where the BIOS update is downloaded. You will need to access this path when you are ready to install the update.



NOTE: If you connect your computer to a network, consult the network administrator before installing any software updates, especially system BIOS updates.

Installing a BIOS update

BIOS installation procedures vary. Follow any instructions that are displayed on the screen after the download is complete. If no instructions are displayed, follow these steps.

1. Select the **Search** icon (select products only) from the taskbar, type `file`, and then select **File Explorer**.
2. Select your hard drive designation. The hard drive designation is typically Local Disk (C:).
3. Using the hard drive path you recorded earlier, open the folder that contains the update.
4. Double-click the file that has an `.exe` extension (for example, `filename.exe`).

The BIOS installation begins.
5. Complete the installation by following the on-screen instructions.



NOTE: After a message on the screen reports a successful installation, you can delete the downloaded file from your hard drive.

Changing the boot order using the f9 prompt

To dynamically choose a boot device for the current startup sequence, follow these steps.

1. Access the Boot Device Options menu:
 - Turn on or restart the computer, and when the HP logo appears, press **f9** to enter the Boot Device Options menu.
2. Select a boot device, press **enter**, and then follow the on-screen instructions.

TPM BIOS settings (select products only)

TPM provides additional security for your computer. You can modify the TPM settings in Computer Setup (BIOS).

 **IMPORTANT:** Before enabling Trusted Platform Module (TPM) functionality on this system, you must ensure that your intended use of TPM complies with relevant local laws, regulations and policies, and approvals or licenses must be obtained if applicable. For any compliance issues arising from your operation or usage of TPM that violates the previously mentioned requirement, you shall bear all the liabilities wholly and solely. HP will not be responsible for any related liabilities.

 **NOTE:** If you change the TPM setting to Hidden, TPM is not visible in the operating system.

To access TPM settings in Computer Setup:

1. Start Computer Setup. See [Using Computer Setup on page 51](#).
2. Select **Security**, select **TPM Embedded Security**, and then follow the on-screen instructions.

Using HP Sure Start (select products only)

Select computer models are configured with HP Sure Start, a technology that monitors the computer's BIOS for attacks or corruption. If the BIOS becomes corrupted or is attacked, HP Sure Start automatically restores the BIOS to its previously safe state, without user intervention.

HP Sure Start is configured and already enabled so that most users can use the HP Sure Start default configuration. Advanced users can customize the default configuration.

To access the latest documentation on HP Sure Start, go to <http://www.hp.com/support>. Select **Find your product**, and then follow the on-screen instructions.

7 Backing up, restoring, and recovering

You can use Windows tools or HP software to back up your information, create a restore point, reset your computer, create recovery media, or restore your computer to its factory state. Performing these standard procedures can return your computer to a working state faster.

 **IMPORTANT:** If you will be performing recovery procedures on a tablet, the tablet battery must be at least 70% charged before you start the recovery process.

 **IMPORTANT:** For a tablet with a detachable keyboard, connect the tablet to the keyboard base before beginning any recovery process.

Backing up information and creating recovery media

These methods of creating recovery media and backups are available on select products only.

Using Windows tools for backing up

HP recommends that you back up your information immediately after initial setup. You can do this task either using Windows Backup locally with an external USB drive or using online tools.

 **IMPORTANT:** Windows is the only option that allows you to back up your personal information. Schedule regular backups to avoid information loss.

 **NOTE:** If computer storage is 32 GB or less, Microsoft® System Restore is disabled by default.

Using the HP Cloud Recovery Download Tool to create recovery media (select products only)

You can use the HP Cloud Recovery Download Tool to create HP Recovery media on a bootable USB flash drive.

For details:

▲ Go to <http://www.hp.com>, search for HP Cloud Recovery, and then select the result that matches the type of computer that you have.

 **NOTE:** If you cannot create recovery media yourself, contact support to obtain recovery discs. Go to <http://www.hp.com/support>, select your country or region, and then follow the on-screen instructions.

 **IMPORTANT:** HP recommends that you follow the [Restoring and recovery methods on page 56](#) to restore your computer before you obtain and use the HP recovery discs. Using a recent backup can return your machine to a working state sooner than using the HP recovery discs. After the system is restored, reinstalling all the operating system software released since your initial purchase can be a lengthy process.

Restoring and recovering your system

You have several tools available to recover your system both within and outside of Windows if the desktop cannot load.

HP recommends that you attempt to restore your system using the [Restoring and recovery methods on page 56](#).

Creating a system restore

System Restore is available in Windows. The System Restore software can automatically or manually create restore points, or snapshots, of the system files and settings on the computer at a particular point.

When you use System Restore, it returns your computer to its state at the time you made the restore point. Your personal files and documents should not be affected.

Restoring and recovery methods

After you run the first method, test to see whether the issue still exists before you proceed to the next method, which might now be unnecessary.

1. Run a Microsoft System Restore.
2. Run Reset this PC.



NOTE: The options **Remove everything** and then **Fully clean the drive** can take several hours to complete and leave no information on your computer. It is the safest way to reset your computer before you recycle it.

3. Recover using HP Recovery media. For more information, see [Recovering using HP Recovery media on page 56](#).

For more information about the first two methods, see the Get Help app:

Select the **Start** button, select **All apps** (select products only), select the **Get Help** app, and then enter the task you want to perform.



NOTE: You must be connected to the internet to access the Get Help app.

Recovering using HP Recovery media

You can use HP Recovery media to recover the original operating system and software programs that were installed at the factory. On select products, it can be created on a bootable USB flash drive using the HP Cloud Recovery Download Tool.

For details, see [Using the HP Cloud Recovery Download Tool to create recovery media \(select products only\) on page 55](#).



NOTE: If you cannot create recovery media yourself, contact support to obtain recovery discs. Go to <http://www.hp.com/support>, select your country or region, and then follow the on-screen instructions.

To recover your system:

- ▲ Insert the HP Recovery media, and then restart the computer.



NOTE: HP recommends that you follow the [Restoring and recovery methods on page 56](#) to restore your computer before you obtain and use the HP recovery discs. Using a recent backup can return your machine to a working state sooner than using the HP recovery discs. After the system is restored, reinstalling all the operating system software released since your initial purchase can be a lengthy process.

Changing the computer boot order

If your computer does not restart using the HP Recovery media, you can change the computer boot order, the order of devices listed in BIOS for startup information. You can select an optical drive or a USB flash drive, depending on the location of your HP Recovery media.

 **IMPORTANT:** For a tablet with a detachable keyboard, connect the tablet to the keyboard base before beginning these steps.

To change the boot order:

1. Insert the HP Recovery media.
2. Access the system **Startup** menu.
 - For computers or tablets with keyboards attached, turn on or restart the computer or tablet, quickly press **esc**, and then press **f9** for boot options.
 - For tablets without keyboards, turn on or restart the tablet, quickly press and hold the volume up button, and then select **f9**.

– or –

Turn on or restart the tablet, quickly press and hold the volume down button, and then select **f9**.
3. Select the optical drive or USB flash drive from which you want to boot, and then follow the on-screen instructions.

Using HP Sure Recover (select products only)

Select computer models are configured with HP Sure Recover, a PC operating system (OS) recovery solution built into the hardware and software. HP Sure Recover can fully restore the HP OS image without installed recovery software.

Using HP Sure Recover, an administrator or user can restore the system and install:

- Latest version of the operating system
- Platform-specific device drivers
- Software applications, in the case of a custom image

To access the latest documentation for HP Sure Recover, go to <http://www.hp.com/support>. Follow the on-screen instructions to find your product and locate your documentation.

8 Using HP PC Hardware Diagnostics

You can use the HP PC Hardware Diagnostics utility to determine whether your computer hardware is running properly. The three versions are HP PC Hardware Diagnostics Windows, HP PC Hardware Diagnostics UEFI (Unified Extensible Firmware Interface), and (for select products only) Remote HP PC Hardware Diagnostics UEFI, a firmware feature.

Using HP PC Hardware Diagnostics Windows (select products only)

HP PC Hardware Diagnostics Windows is a Windows-based utility that allows you to run diagnostic tests to determine whether the computer hardware is functioning properly. The tool runs within the Windows operating system to diagnose hardware failures.

If HP PC Hardware Diagnostics Windows is not installed on your computer, first you must download and install it. To download HP PC Hardware Diagnostics Windows, see [Downloading HP PC Hardware Diagnostics Windows on page 59](#).

Using an HP PC Hardware Diagnostics Windows hardware failure ID code

When HP PC Hardware Diagnostics Windows detects a failure that requires hardware replacement, a 24-digit failure ID code is generated for select component tests. For interactive tests, such as keyboard, mouse, or audio and video palette, you must perform troubleshooting steps before you can receive a failure ID.

- ▲ You have several options after you receive a failure ID:
 - Select **Next** to open the Event Automation Service (EAS) page, where you can log the case.
– or –
 - Scan the QR code with your mobile device, which takes you to the EAS page, where you can log the case.
– or –
 - Select the box next to the 24-digit failure ID to copy your failure code and send it to support.

Accessing HP PC Hardware Diagnostics Windows

After HP PC Hardware Diagnostics Windows is installed, you can access it from HP Support Assistant or the Start menu.

Accessing HP PC Hardware Diagnostics Windows from HP Help and Support (select products only)

After HP PC Hardware Diagnostics Windows is installed, follow these steps to access it from HP Help and Support.

1. Select the **Start** button, and then select **HP Help and Support**.
2. Select **HP PC Hardware Diagnostics Windows**.
3. When the tool opens, select the type of diagnostic test that you want to run, and then follow the on-screen instructions.



NOTE: To stop a diagnostic test, select **Cancel**.

Accessing HP PC Hardware Diagnostics Windows from HP Support Assistant

After HP PC Hardware Diagnostics Windows is installed, follow these steps to access it from HP Support Assistant.

1. Select the **Search** icon (select products only) from the taskbar, type `support`, and then select **HP Support Assistant**.

– or –
Select the question mark icon (select products only) in the taskbar.
2. Select **Troubleshooting and fixes** (select products only) or **Fixes & Diagnostics**.
3. Select **Diagnostics**, and then select **HP PC Hardware Diagnostics Windows**.
4. When the tool opens, select the type of diagnostic test that you want to run, and then follow the on-screen instructions.



NOTE: To stop a diagnostic test, select **Cancel**.

Accessing HP PC Hardware Diagnostics Windows from the Start menu (select products only)

After HP PC Hardware Diagnostics Windows is installed, follow these steps to access it from the Start menu.

1. Select the **Start** button, and then select **All apps** (select products only).
2. Select **HP PC Hardware Diagnostics Windows**.
3. When the tool opens, select the type of diagnostic test that you want to run, and then follow the on-screen instructions.



NOTE: To stop a diagnostic test, select **Cancel**.

Downloading HP PC Hardware Diagnostics Windows

The HP PC Hardware Diagnostics Windows downloading instructions are provided in English only. You must use a Windows computer to download this tool because only .exe files are provided.

Downloading the latest HP PC Hardware Diagnostics Windows version from HP

To download HP PC Hardware Diagnostics Windows from HP, follow these steps.

1. Go to <http://www.hp.com/go/techcenter/pcdiags>. The HP PC Diagnostics home page is displayed.
2. Select **Download HP Diagnostics Windows**, and then select the specific Windows diagnostics version to download to your computer or a USB flash drive.

The tool downloads to the selected location.

Downloading the HP PC Hardware Diagnostics Windows from the Microsoft Store

You can download the HP PC Hardware Diagnostics Windows from the Microsoft Store.

1. Select the Microsoft Store app on your desktop.
– or –
Select the **Search** icon (select products only) in the taskbar, and then type `Microsoft Store`.
2. Enter `HP PC Hardware Diagnostics Windows` in the **Microsoft Store** search box.
3. Follow the on-screen directions.

The tool downloads to the selected location.

Downloading HP Hardware Diagnostics Windows by product name or number (select products only)

You can download HP PC Hardware Diagnostics Windows by product name or number.



NOTE: For some products, you might have to download the software to a USB flash drive by using the product name or number.

1. Go to <http://www.hp.com/support>.
2. Select **Software and Drivers**, select your type of product, and then enter the product name or number in the search box that is displayed.
3. In the **Diagnostics** section, select **Download**, and then follow the on-screen instructions to select the specific Windows diagnostics version to be downloaded to your computer or USB flash drive.

The tool downloads to the selected location.

Installing HP PC Hardware Diagnostics Windows

To install HP PC Hardware Diagnostics Windows, navigate to the folder on your computer or the USB flash drive where the .exe file downloaded, double-click the .exe file, and then follow the on-screen instructions.

Using HP PC Hardware Diagnostics UEFI

HP PC Hardware Diagnostics UEFI (Unified Extensible Firmware Interface) allows you to run diagnostic tests to determine whether the computer hardware is functioning properly. The tool runs outside the operating system so that it can isolate hardware failures from issues that are caused by the operating system or other software components.



NOTE: For some products, you must use a Windows computer and a USB flash drive to download and create the HP UEFI support environment because only .exe files are provided. For more information, see [Downloading HP PC Hardware Diagnostics UEFI to a USB flash drive on page 61](#).

If your PC does not start in Windows, you can use HP PC Hardware Diagnostics UEFI to diagnose hardware issues.

Using an HP PC Hardware Diagnostics UEFI hardware failure ID code

When HP PC Hardware Diagnostics UEFI detects a failure that requires hardware replacement, a 24-digit failure ID code is generated.

For assistance in solving the problem:

- ▲ Select **Contact HP**, accept the HP privacy disclaimer, and then use a mobile device to scan the failure ID code that appears on the next screen. The HP Customer Support - Service Center page appears with your failure ID and product number automatically filled in. Follow the on-screen instructions.

– or –

Contact support, and provide the failure ID code.

 **NOTE:** To start diagnostics on a convertible computer, your computer must be in notebook mode, and you must use the attached keyboard.

 **NOTE:** If you need to stop a diagnostic test, press `esc`.

Starting HP PC Hardware Diagnostics UEFI

To start HP PC Hardware Diagnostics UEFI, follow this procedure.

1. Turn on or restart the computer, and quickly press `esc`.
2. Press `f2`.

The BIOS searches three places for the diagnostic tools, in the following order:

- a. Connected USB flash drive

 **NOTE:** To download the HP PC Hardware Diagnostics UEFI tool to a USB flash drive, see [Downloading the latest HP PC Hardware Diagnostics UEFI version on page 61](#).

- b. Hard drive

- c. BIOS

3. When the diagnostic tool opens, select a language, select the type of diagnostic test you want to run, and then follow the on-screen instructions.

Downloading HP PC Hardware Diagnostics UEFI to a USB flash drive

Downloading HP PC Hardware Diagnostics UEFI to a USB flash drive can be useful in some situations.

- HP PC Hardware Diagnostics UEFI is not included in the preinstallation image.
- HP PC Hardware Diagnostics UEFI is not included in the HP Tool partition.
- The hard drive is damaged.

 **NOTE:** The HP PC Hardware Diagnostics UEFI downloading instructions are provided in English only, and you must use a Windows computer to download and create the HP UEFI support environment because only `.exe` files are provided.

Downloading the latest HP PC Hardware Diagnostics UEFI version

To download the latest HP PC Hardware Diagnostics UEFI version to a USB flash drive, follow this procedure.

1. Go to <http://www.hp.com/go/techcenter/pcdiags>. The HP PC Diagnostics home page is displayed.
2. Select **Download HP Diagnostics UEFI**, and then select **Run**.

Downloading HP PC Hardware Diagnostics UEFI by product name or number (select products only)

You can download HP PC Hardware Diagnostics UEFI by product name or number (select products only) to a USB flash drive.



NOTE: For some products, you might have to download the software to a USB flash drive by using the product name or number.

1. Go to <http://www.hp.com/support>.
2. Enter the product name or number, select your computer, and then select your operating system.
3. In the **Diagnostics** section, follow the on-screen instructions to select and download the specific UEFI Diagnostics version for your computer.

Using Remote HP PC Hardware Diagnostics UEFI settings (select products only)

Remote HP PC Hardware Diagnostics UEFI is a firmware (BIOS) feature that downloads HP PC Hardware Diagnostics UEFI to your computer. It can then execute the diagnostics on your computer, and it might upload results to a preconfigured server.

For more information about Remote HP PC Hardware Diagnostics UEFI, go to <http://www.hp.com/go/techcenter/pcdiags>, and then select **Find out more**.

Downloading Remote HP PC Hardware Diagnostics UEFI

HP Remote PC Hardware Diagnostics UEFI is also available as a SoftPaq that you can download to a server.

Downloading the latest Remote HP PC Hardware Diagnostics UEFI version

You can download the latest HP PC Hardware Diagnostics UEFI version to a USB flash drive.

1. Go to <http://www.hp.com/go/techcenter/pcdiags>. The HP PC Diagnostics home page is displayed.
2. Select **Download Remote Diagnostics**, and then select **Run**.

Downloading Remote HP PC Hardware Diagnostics UEFI by product name or number

You can download HP Remote PC Hardware Diagnostics UEFI by product name or number.



NOTE: For some products, you might have to download the software by using the product name or number.

1. Go to <http://www.hp.com/support>.
2. Select **Software and Drivers**, select your type of product, enter the product name or number in the search box that is displayed, select your computer, and then select your operating system.
3. In the **Diagnostics** section, follow the on-screen instructions to select and download the **Remote UEFI** version for the product.

Customizing Remote HP PC Hardware Diagnostics UEFI settings

Using the Remote HP PC Hardware Diagnostics setting in Computer Setup (BIOS), you can perform several customizations.

- Set a schedule for running diagnostics unattended. You can also start diagnostics immediately in interactive mode by selecting **Execute Remote HP PC Hardware Diagnostics**.
- Set the location for downloading the diagnostic tools. This feature provides access to the tools from the HP website or from a server that has been preconfigured for use. Your computer does not require the traditional local storage (such as a hard drive or USB flash drive) to run remote diagnostics.
- Set a location for storing the test results. You can also set the user name and password that you use for uploads.
- Display status information about the diagnostics run previously.

To customize Remote HP PC Hardware Diagnostics UEFI settings, follow these steps:

1. Turn on or restart the computer, and when the HP logo appears, press **f10** to enter Computer Setup.
2. Select **Advanced**, and then select **Settings**.
3. Make your customization selections.
4. Select **Main**, and then **Save Changes and Exit** to save your settings.

Your changes take effect when the computer restarts.

9 Specifications

This chapter provides specifications for your computer system.

Computer specifications

This section provides specifications for your computer. When traveling with your computer, the computer dimensions and weights, as well as input power ratings and operating specifications, provide helpful information.

Table 9-1 Computer specifications

	Metric	U.S.
Dimensions		
Width	335.95 mm	13.23 in
Depth	229.95 mm	9.05 in
Height	21.9 mm	0.86 in
Weight	1.66 kg	3.66 lbs
Input power		
Operating voltage and current	5 V dc @ 2 A / 12 V dc @ 3 A / 15 V dc @ 3 A – 45 W USB-C	
	5 V dc @ 3 A / 9 V dc @ 3 A / 12 V dc @ 3.75 A / 15 V dc @ 3 A – 45 W USB-C	
	5 V dc @ 3 A / 9 V dc @ 3 A / 10 V dc @ 3.75 A / 12 V dc @ 3.75 A / 15 V dc @ 3 A / 20 V dc @ 2.25 A – 45 W USB-C	
	9.5 V dc @ 3.33 A – 65 W	
Temperature		
Operating	5°C to 35°C	41°F to 95°F
Nonoperating	–20°C to 60°C	–4°F to 140°F
Relative humidity (noncondensing)		
Operating	10% to 90%	
Nonoperating	5% to 95%	
Maximum altitude (unpressurized)		
Operating	–15 m to 3,048 m	–50 ft to 10,000 ft
Nonoperating	–15 m to 12,192 m	–50 ft to 40,000 ft
NOTE: Applicable product safety standards specify thermal limits for plastic surfaces. The device operates well within this range of temperatures.		

35.6 cm (14.0in) display specifications

This section provides specifications for your display.

Table 9-2 Display specifications

	Metric	U.S.
Active diagonal size	35.6 cm	14.0 in
Resolution	1920 × 1080 (FHD) 1366 × 768 (HD)	
Surface treatment	Antiglare (nontouch)	
Brightness	250 nits	
Viewing angle	UWVA SVA	
Backlight	LED	
Display panel interface	eDP	

10 Statement of memory volatility

For general information regarding nonvolatile memory in HP business computers, and to restore nonvolatile memory that can contain personal data after the system has been turned off and the hard drive has been removed, use these instructions.

HP business computer products that use Intel®-based or AMD®-based system boards contain volatile DDR memory. The amount of nonvolatile memory present in the system depends upon the system configuration. Intel-based and AMD-based system boards contain nonvolatile memory subcomponents as originally shipped from HP, with the following assumptions:

- No subsequent modifications were made to the system.
- No applications, features, or functionality were added to or installed on the system.

Following system shutdown and removal of all power sources from an HP business computer system, personal data can remain on volatile system memory (DIMMs) for a finite period of time and also remains in nonvolatile memory. Use the following steps to remove personal data from the computer, including the nonvolatile memory found in Intel-based and AMD-based system boards.

 **NOTE:** If your tablet has a keyboard base, connect to the keyboard base before beginning steps in this chapter.

Current BIOS steps

Use these instructions to restore nonvolatile memory.

1. Follow these steps to restore the nonvolatile memory that can contain personal data. Restoring or reprogramming nonvolatile memory that does not store personal data is neither necessary nor recommended.

- a. Turn on or restart the computer, and then quickly press **esc**.

 **NOTE:** If the system has a BIOS administrator password, type the password at the prompt.

- b. Select **Main**, select **Apply Factory Defaults and Exit**, and then select **Yes** to load defaults. The computer restarts.

- c. During the restart, press **esc** while the "Press the ESC key for Startup Menu" message is displayed at the bottom of the screen.

 **NOTE:** If the system has a BIOS administrator password, type the password at the prompt.

- d. Select the **Security** menu, select **Restore Security Settings to Factory Defaults**, and then select **Yes** to restore security level defaults. The computer reboots.

- e. During the reboot, press **esc** while the "Press the ESC key for Startup Menu" message is displayed at the bottom of the screen.

 **NOTE:** If the system has a BIOS administrator password, type the password at the prompt.

- f. If an asset or ownership tag is set, select the **Security** menu and scroll down to the **Utilities** menu. Select **System IDs**, and then select **Asset Tracking Number**. Clear the tag, and then make the selection to return to the prior menu.
- g. If a DriveLock password is set, select the **Security** menu, and scroll down to **Hard Drive Utilities** under the **Utilities** menu. Select **Hard Drive Utilities**, select **DriveLock**, and then clear the check box for **DriveLock password on restart**. Select **OK** to proceed.
- h. Select the **Main** menu, and then select **Reset BIOS Security to factory default**. Select **Yes** at the warning message. The computer reboots.
- i. During the reboot, press **esc** while the "Press the ESC key for Startup Menu" message is displayed at the bottom of the screen.



NOTE: If the system has a BIOS administrator password, type the password at the prompt.

- j. Select the **Main** menu, select **Apply Factory Defaults and Exit**, select **Yes** to save changes and exit, and then select **Shutdown**.
 - k. Reboot the system. If the system has a Trusted Platform Module (TPM), fingerprint reader, or both, one or two prompts will appear—one to clear the TPM and the other to Reset Fingerprint Sensor. Press or tap **f1** to accept or **f2** to reject.
 - l. Remove all power and system batteries for at least 24 hours.
2. Complete one of the following:
- Remove and retain the storage drive.
– or –
 - Clear the drive contents by using a third-party utility designed to erase data from an SSD.
– or –
 - Clear the contents of the drive by using the following BIOS Setup Secure Erase command option steps:



NOTE: If you clear data using Secure Erase, you cannot recover it.

- a. Turn on or restart the computer, and then quickly press **esc**.
- b. Select the **Security** menu and scroll down to the **esc** menu.
- c. Select **Hard Drive Utilities**.
- d. Under **Utilities**, select **Secure Erase**, select the hard drive storing the data you want to clear, and then follow the on-screen instructions to continue.
– or –
Clear the contents of the drive using the following Disk Sanitizer commands steps:
 - i. Turn on or restart the computer, and then quickly press **esc**.
 - ii. Select the **Security** menu and scroll down to the **Utilities** menu.
 - iii. Select **Hard Drive Utilities**.

- iv. Under **Utilities**, select **Disk Sanitizer**, select the hard drive with the data that you want to clear, and then follow the on-screen instructions to continue.

 **NOTE:** The amount of time it takes for Disk Sanitizer to run can take several hours. Plug the computer into an AC outlet before starting.

Nonvolatile memory usage

Use this table to troubleshoot nonvolatile memory usage.

Table 10-1 Troubleshooting steps for nonvolatile memory usage

Nonvolatile memory type	Amount (Size)	Does this memory store customer data?	Does this memory retain data when power is removed?	What is the purpose of this memory?	How is data entered into this memory?	How is this memory write-protected?
HP Sure Start flash (select models only)	8 MB	No	Yes	Provides protected backup of critical System BIOS code, EC firmware, and critical computer configuration data for select platforms that support HP Sure Start. For more information, see Using HP Sure Start (select products only) on page 72.	Data cannot be written to this device via the host processor. The content is managed solely by the HP Sure Start Embedded Controller.	This memory is protected by the HP Sure Start Embedded Controller.
Real Time Clock (RTC) battery backed-up CMOS configuration memory	256 bytes	No	Yes	Stores system date and time and noncritical data.	RTC battery backed-up CMOS is programmed using Computer Setup (BIOS), or by changing the Windows date & time.	This memory is not write-protected.
Controller (NIC) EEPROM	64 KB (not customer accessible)	No	Yes	Stores NIC configuration and NIC firmware.	NIC EEPROM is programmed using a utility from the NIC vendor that can be run from DOS.	A utility must be used to write data to this memory and is available from the NIC vendor. Writing data to this ROM in an inappropriate manner will render the NIC nonfunctional.
DIMM Serial Presence Detect (SPD)	256 bytes per memory module, 128 bytes	No	Yes	Stores memory module information.	DIMM SPD is programmed by the memory vendor.	Data cannot be written to this memory when the module is installed in a computer.

Table 10-1 Troubleshooting steps for nonvolatile memory usage (continued)

Nonvolatile memory type	Amount (Size)	Does this memory store customer data?	Does this memory retain data when power is removed?	What is the purpose of this memory?	How is data entered into this memory?	How is this memory write-protected?
configuration data	programmable (not customer accessible)					The specific write-protection method varies by memory vendor.
System BIOS	9 MB	Yes	Yes	Stores system BIOS code and computer configuration data.	System BIOS code is programmed at the factory. Code is updated when the system BIOS is updated. Configuration data and settings are entered using the Computer Setup (BIOS) or a custom utility.	NOTE: Writing data to this ROM in an inappropriate manner can render the computer nonfunctional. A utility must be used for writing data to this memory and is available on the HP website; go to http://www.hp.com/support . Select Find your product , and then follow the on-screen instructions.
Intel Management Engine Firmware (present only in select Elite or Z models. For more information, go to http://www.hp.com/support . Select Identify your product for manuals and specific product information , and then follow the on-screen instructions.)	1.5 MB or 7 MB	Yes	Yes	Stores Management Engine Code, Settings, Provisioning Data and iAMT third-party data store.	Management Engine Code is programmed at the factory. Code is updated via Intel secure firmware update utility. Unique Provisioning Data can be entered at the factory or by an administrator using the Management Engine (MEBx) setup utility. The third-party data store contents can be populated by a remote management console or local applications that have been registered by an administrator to have access to the space.	The Intel chipset is configured to enforce hardware protection to block all direct read-write access to this area. An Intel utility must be used for updating the firmware. Only firmware updates digitally signed by Intel can be applied using this utility.
Bluetooth flash (select products only)	2 megabits	No	Yes	Stores Bluetooth configuration and firmware.	Bluetooth flash is programmed at the factory. Tools for writing data to this memory are not publicly available but can be obtained from the silicon vendor.	A utility must be used for writing data to this memory and is made available through newer versions of the driver whenever the flash requires an upgrade.
802.11 WLAN EEPROM	4 kilobits to 8 kilobits	No	Yes	Stores configuration and calibration data.	802.11 WLAN EEPROM is programmed at the factory. Tools for writing data to this memory are not made public.	A utility must be used for writing data to this memory and is typically not made available to the public unless a firmware upgrade is necessary

Table 10-1 Troubleshooting steps for nonvolatile memory usage (continued)

Nonvolatile memory type	Amount (Size)	Does this memory store customer data?	Does this memory retain data when power is removed?	What is the purpose of this memory?	How is data entered into this memory?	How is this memory write-protected?
						to address a unique issue.
Camera (select products only)	64 kilobits	No	Yes	Stores camera configuration and firmware.	Camera memory is programmed using a utility from the device manufacturer that can be run from Windows.	A utility must be used for writing data to this memory and is typically not made available to the public unless a firmware upgrade is necessary to address a unique issue.
Fingerprint reader (select products only)	512 KB flash	Yes	Yes	Stores fingerprint templates.	Fingerprint reader memory is programmed by user enrollment in HP ProtectTools Security Manager.	Only a digitally signed application can make the call to write to the flash.

Questions and answers

Use this section to answer your questions about nonvolatile memory.

1. How can the BIOS settings be restored (returned to factory settings)?

 **IMPORTANT:** The restore defaults feature does not securely erase any information on your hard drive. See question and answer 6 for steps to securely erase information.

The restore defaults feature does not reset the Custom Secure Boot keys. See question and answer 7 for information about resetting the keys.

- Turn on or restart the computer, and then quickly press **esc**.
- Select **Main**, and then select **Apply Factory Defaults and Exit**.
- Follow the on-screen instructions.
- Select **Main**, select **Save Changes and Exit**, and then follow the on-screen instructions.

2. What is a UEFI BIOS, and how is it different from a legacy BIOS?

The Unified Extensible Firmware Interface (UEFI) BIOS is an industry-standard software interface between the platform firmware and an operating system (OS). It replaces the older BIOS architecture but supports much of the legacy BIOS functionality.

Like the legacy BIOS, the UEFI BIOS provides an interface to display the system information and configuration settings and to change the configuration of your computer before an OS is loaded. BIOS provides a secure runtime environment that supports a Graphic User Interface (GUI). In this environment, you can use either a pointing device (touch screen, touchpad, pointing stick, or USB mouse) or the keyboard to navigate and make menu and configuration selections. The UEFI BIOS also contains basic system diagnostics.

The UEFI BIOS provides functionality beyond that of the legacy BIOS. In addition, the UEFI BIOS works to initialize the computer's hardware before loading and executing the OS; the runtime environment allows the loading and execution of software programs from storage devices to provide more functionality, such as advanced hardware diagnostics (with the ability to display more detailed system information) and advanced firmware management and recovery software.

HP has provided options in Computer Setup (BIOS) to allow you to run in legacy BIOS, if required by the operating system. Examples of this requirement would be if you upgrade or downgrade the OS.

3. Where is the UEFI BIOS located?

The UEFI BIOS is located on a flash memory chip. You must use a utility to write to the chip.

4. What kind of configuration data is stored on the DIMM Serial Presence Detect (SPD) memory module? How would this data be written?

The DIMM SPD memory contains information about the memory module, such as size, serial number, data width, speed and timing, voltage, and thermal information. This information is written by the module manufacturer and stored on an EEPROM. You cannot write to this EEPROM when the memory module is installed in a computer. Third-party tools do exist that can write to the EEPROM when the memory module is not installed in a computer. Various third-party tools are available to read SPD memory.

5. What is meant by “Restore the nonvolatile memory found in Intel-based system boards”?

This message relates to clearing the Real Time Clock (RTC) CMOS memory that contains computer configuration data.

6. How can the BIOS security be reset to factory defaults and erase the data?

 **IMPORTANT:** Resetting results in the loss of information.

These steps do not reset Custom Secure Boot Keys. See question and answer 7 for information about resetting the keys.

- a. Turn on or restart the computer, and then quickly press **esc**.
- b. Select **Main**, and then select **Reset Security to Factory Defaults**.
- c. Follow the on-screen instructions.
- d. Select **Main**, select **Save Changes and Exit**, and then follow the on-screen instructions.

7. How can the Custom Secure Boot Keys be reset?

Secure Boot is a feature to ensure that only authenticated code can start on a platform. If you enabled Secure Boot and created Custom Secure Boot Keys, disabling Secure Boot does not clear the keys. You must also select to clear the Custom Secure Boot Keys. Use the same Secure Boot access procedure that you used to create the Custom Secure Boot Keys, but select to clear or delete all Secure Boot Keys.

- a. Turn on or restart the computer, and then quickly press **esc**.

- b. Select the **Security** menu, select **Secure Boot Configuration**, and then follow the on-screen instructions.
- c. At the **Secure Boot Configuration** window, select **Secure Boot**, select **Clear Secure Boot Keys**, and then follow the on-screen instructions to continue.

Using HP Sure Start (select products only)

Select computer models are configured with HP Sure Start, a technology that continuously monitors your computer's BIOS for attacks or corruption.

If the BIOS becomes corrupted or is attacked, HP Sure Start restores the BIOS to its previously safe state, without user intervention. Those select computer models ship with HP Sure Start configured and enabled. HP Sure Start is configured and already enabled so that most users can use the HP Sure Start default configuration. Advanced users can customize the default configuration.

To access the latest documentation on HP Sure Start, go to <http://www.hp.com/support>.

11 Power cord set requirements

This chapter provides power cord requirements for countries and regions.

The wide-range input feature of the computer permits it to operate from any line voltage from 100 V ac to 120 V ac, or from 220 V ac to 240 V ac.

The three-conductor power cord set included with the computer meets the requirements for use in the country or region where the equipment is purchased.

Power cord sets for use in other countries or regions must meet the requirements of the country and region where the computer is used.

Requirements for all countries

These power cord requirements are applicable to all countries and regions.

- The length of the power cord set must be at least **1.0 m** (3.3 ft) and no more than **2.0 m** (6.5 ft).
- All power cord sets must be approved by an acceptable accredited agency responsible for evaluation in the country or region where the power cord set will be used.
- The power cord sets must have a minimum current capacity of 10 A and a nominal voltage rating of 125 V ac or 250 V ac, as required by the power system of each country or region.
- The appliance coupler must meet the mechanical configuration of an EN 60 320/IEC 320 Standard Sheet C13 connector for mating with the appliance inlet on the back of the computer.

Requirements for specific countries and regions

To determine power cord requirements for specific countries and regions, use this table.

Table 11-1 Power cord requirements for specific countries and regions

Country/region	Accredited agency	Applicable note number
Argentina	IRAM	1
Australia	SAA	1
Austria	OVE	1
Belgium	CEBEC	1
Brazil	ABNT	1
Canada	CSA	2
Chile	IMQ	1
Denmark	DEMKO	1
Finland	FIMKO	1
France	UTE	1
Germany	VDE	1

Table 11-1 Power cord requirements for specific countries and regions (continued)

Country/region	Accredited agency	Applicable note number
India	BIS	1
Israel	SII	1
Italy	IMQ	1
Japan	JIS	3
Netherlands	KEMA	1
New Zealand	SANZ	1
Norway	NEMKO	1
People's Republic of China	CCC	4
Saudi Arabia	SASO	7
Singapore	PSB	1
South Africa	SABS	1
South Korea	KTL	5
Sweden	SEMKO	1
Switzerland	SEV	1
Taiwan	BSMI	6
Thailand	TISI	1
United Kingdom	ASTA	1
United States	UL	2

1. The flexible cord must be Type H05VV-F, three-conductor, 0.75 mm² conductor size. Power cord set fittings (appliance coupler and wall plug) must bear the certification mark of the agency responsible for evaluation in the country or region where it will be used.
2. The flexible cord must be Type SVT/SJT or equivalent, No. 18 AWG, three-conductor. The wall plug must be a two-pole grounding type with a NEMA 5-15P (15 A, 125 V ac) or NEMA 6-15P (15 A, 250 V ac) configuration. CSA or C-UL mark. UL file number must be on each element.
3. The appliance coupler, flexible cord, and wall plug must bear a T mark and registration number in accordance with the Japanese Dentori Law. The flexible cord must be Type VCTF, three-conductor, 0.75 mm² or 1.25 mm² conductor size. The wall plug must be a two-pole grounding type with a Japanese Industrial Standard C8303 (7 A, 125 V ac) configuration.
4. The flexible cord must be Type RVV, three-conductor, 0.75 mm² conductor size. Power cord set fittings (appliance coupler and wall plug) must bear the CCC certification mark.
5. The flexible cord must be Type H05VV-F three-conductor, 0.75 mm² conductor size. KTL logo and individual approval number must be on each element. Approval number and logo must be printed on a flag label.
6. The flexible cord must be Type HVCTF three-conductor, 1.25 mm² conductor size. Power cord set fittings (appliance coupler, cable, and wall plug) must bear the BSMI certification mark.
7. For 127 V ac, the flexible cord must be Type SVT or SJT 3-conductor, 18 AWG, with plug NEMA 5-15P (15 A, 125 V ac), with UL and CSA or C-UL marks. For 240 V ac, the flexible cord must be Type H05VV-F three-conductor, 0.75 mm² or 1.00 mm² conductor size, with plug BS 1363/A with BSI or ASTA marks.

12 Recycling

When a nonrechargeable or rechargeable battery has reached the end of its useful life, do not dispose of the battery in general household waste. Follow the local laws and regulations in your area for battery disposal.

HP encourages customers to recycle used electronic hardware, HP original print cartridges, and rechargeable batteries. For more information about recycling programs, see the HP website at <http://www.hp.com/recycle>.

Index

- A**
 - AC adapters, spare part
 - numbers 15
 - audio-out (headphone)/audio-in (microphone) combo jack, identifying 4
 - audio, product description 1
- B**
 - backup, creating 55
 - backups 55
 - battery
 - illustrated 13
 - spare part number 13
 - battery light 5
 - BIOS
 - determining version 52
 - downloading an update 52, 53
 - updating 52
 - Bluetooth label 10
 - boot order
 - changing using the f9 prompt 53
 - boot order, changing 57
 - bottom cover
 - illustrated 13
 - removal 28
 - spare part number 13, 28
 - buttons
 - left touchpad 8
 - right touchpad 8
- C**
 - camera 7
 - identifying 7
 - camera light, identifying 7
 - camera module
 - illustrated 15
 - spare part number 15
 - camera privacy cover, identifying 7
 - caring for your computer 23
 - cautions
 - electrostatic discharge 19, 20
 - cleaning your computer 23
 - caring for wood veneer 25
 - disinfecting 24
 - HP Easy Clean 23
 - removing dirt and debris 23
 - components
 - display 6
 - keyboard area 7
 - left side 5
 - right side 4
 - computer major components 12
 - Computer Setup
 - navigating and selecting 51
 - restoring factory settings 51
 - starting 51
 - computer specifications 64
 - connector, power 5
- D**
 - display
 - specifications 64, 65
 - display assembly
 - illustrated 13
 - spare part numbers 13
 - subcomponents 14
 - display back cover
 - illustrated 15
 - spare part number 15
 - display bezel
 - illustrated 14
 - spare part number 14
 - display cable
 - illustrated 15
 - spare part number 15
 - display components 6
 - display panel
 - illustrated 15
 - product description 1
 - spare part number 15
- E**
 - electrostatic discharge (ESD) 19, 20
 - preventing damage 19-21
 - esc key, identifying 9
- G**
 - graphics, product description 1
 - grounding methods 19-21
 - guidelines
 - packaging 19, 25
 - transporting 19, 25
 - workstation 19
- H**
 - hard drive
 - product description 1
 - specifications 64
 - HDMI port, identifying 5
 - heat sink
 - illustrated 13
 - removal 37
 - spare part number 13
 - spare part numbers 37
 - HP PC Hardware Diagnostics UEFI
 - downloading 61
 - failure ID code 60
 - starting 61
 - using 60
 - HP PC Hardware Diagnostics Windows
 - accessing 58, 59
 - downloading 59
 - failure ID code 58
 - installing 60
 - using 58
 - HP Recovery media
 - recovery 56
 - HP Sure Recover 57
 - HP Sure Start 66, 72
- I**
 - illustrated parts catalog 12
- J**
 - jacks
 - audio-out (headphone)/audio-in (microphone) combo 4
 - network 5
 - RJ-45 (network) 5
- K**
 - keyboard
 - product description 2
 - keys
 - esc 9
 - power 9
 - Windows 9

L

labels

- Bluetooth 10
- regulatory 10
- serial number 10
- service 10
- wireless certification 10
- WLAN 10

left side components 5

lights

- AC adapter and battery 5
- battery 5
- camera 7
- RJ-45 (network) 5

low blue light mode 6

M

memory

- nonvolatile 66
- volatile 66

memory module

- product description 1

microphone

- product description 1

microphones, identifying 7

model name 1

N

network jack, identifying 5

nonvolatile memory 66

O

operating system, product description 2

P

packaging guidelines 19, 25

pointing device, product description 2

ports

- HDMI 5
- product description 2
- USB SuperSpeed 4, 5
- USB Type-C power connector and SuperSpeed port 5

power connector

- identifying 5
- identifying USB Type-C 5

power connector cable

- removal 39
- spare part number 39

power cord

- requirements for all countries 73
- requirements for specific countries and regions 73
- set requirements 73

power cords, spare part numbers 15

power key, identifying 9

power requirements, product description 2

primary storage

- product description 1

processor

- product description 1

product description

- audio 1
- display panel 1
- graphics 1
- hard drive 1
- keyboard 2
- memory module 1
- microphone 1
- operating system 2
- pointing device 2
- ports 2
- power requirements 2
- primary storage 1
- processors 1
- product name 1
- serviceability 3
- solid-state drive 1
- video 1
- wireless 1

product name 1

product name and number, computer 10

R

recovery 55

- discs 56
- media 56
- USB flash drive 56

recovery media 55

- creating using HP Cloud Recovery Download Tool 55
- creating using Windows tools 55

regulatory information

- regulatory label 10
- wireless certification labels 10

Remote HP PC Hardware Diagnostics

- UEFI settings customizing 62

using 62

removal and replacement

- procedures 28
- solid-state drive 32

removing personal data from volatile system memory 66

restoring 55

restoring and recovery methods 56

right side components 4

RJ-45 (network) jack, identifying 5

RJ-45 (network) lights, identifying 5

RTC battery

- illustrated 13
- spare part number 13

S

Screw Kit, spare part number 15

security cable slot, identifying 4

serial number, computer 10

service labels, locating 10

serviceability, product description 3

setup utility

- navigating and selecting 51
- restoring factory settings 51

slots

- security cable 4

solid-state drive

- illustrated 13
- product description 1
- removal and replacement 32
- spare part number 13

spare part country codes 49

speaker

- illustrated 13
- removal 35
- spare part number 13
- spare part numbers 35

special keys, using 8

specifications

- computer 64
- display 64, 65
- hard drive 64

static electricity 19, 20

support information 25

Sure Start

- using 54

system board

- illustrated 13
- removal 40
- spare part number 13
- spare part numbers 40

- system memory, removing personal data from volatile 66
- system restore 56
- system restore point, creating 55
- removal 30
- spare part number 13
- spare part numbers 30
- workstation guidelines 19

T

- top cover with keyboard
 - illustrated 13
 - spare part number 13
 - spare part numbers 49
- touchpad
 - illustrated 13
 - removal 36
 - settings 7
 - spare part number 13, 36
- touchpad buttons
 - identifying 8
- touchpad zone, identifying 8
- TPM settings 54
- transporting guidelines 19, 25
- traveling with the computer 10

U

- USB SuperSpeed port,
 - identifying 4, 5
- USB Type-C power connector and SuperSpeed port, identifying 5
- USB/audio board
 - illustrated 13
 - removal 34
 - spare part number 13, 34

V

- video, product description 1

W

- Windows
 - backup 55
 - recovery media 55
 - system restore point 55
- Windows key, identifying 9
- Windows tools, using 55
- wireless antennas
 - illustrated 15
 - spare part number 15
- wireless antennas, identifying 6
- wireless certification label 10
- wireless, product description 1
- WLAN antennas, identifying 6
- WLAN device 10
- WLAN label 10
- WLAN module
 - illustrated 13