

Alchemy 2.0 Magnetic RGB LED strip



Daisy chain with BitFenix RGB accessories



Daisy chain with BitFenix RGB LED strips

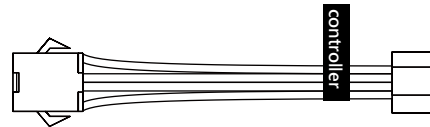

Connect to control board on BitFenix cases

Connect to control box

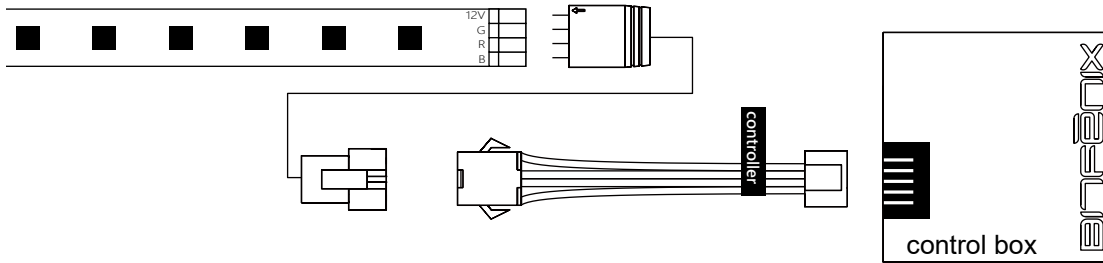

Connect to control board on BitFenix cases

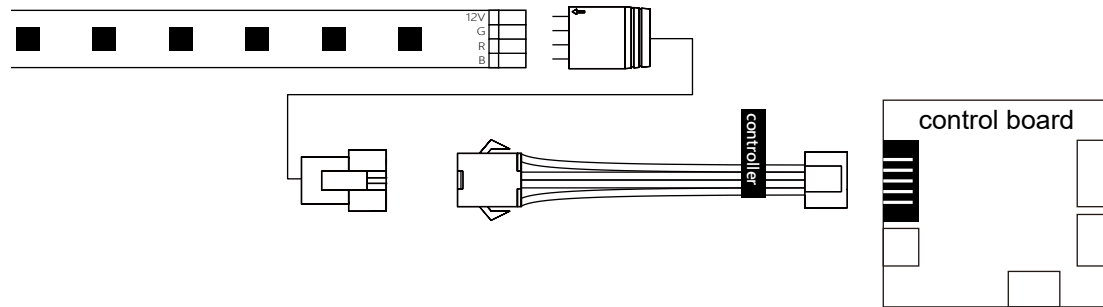

Daisy chain with BitFenix RGB LED strips

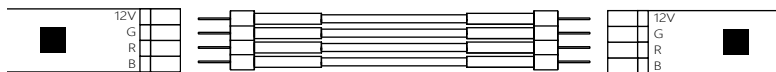

Daisy chain with BitFenix RGB LED accessories

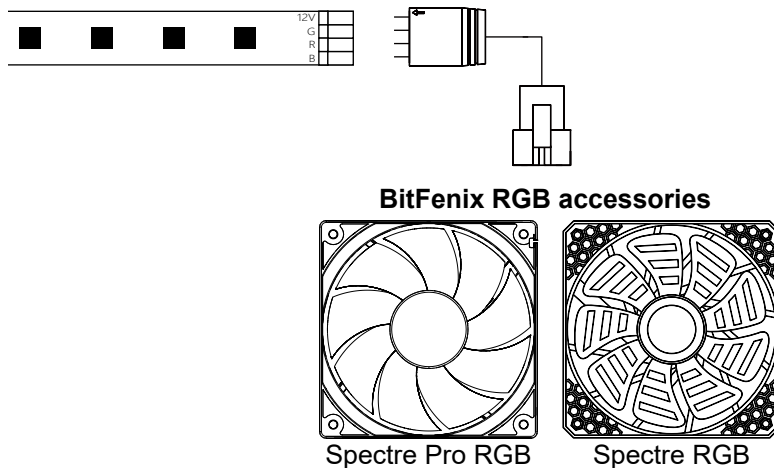

Connect to motherboard

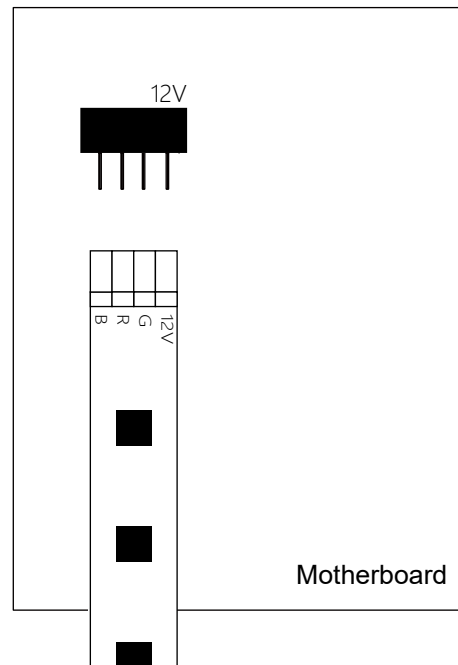

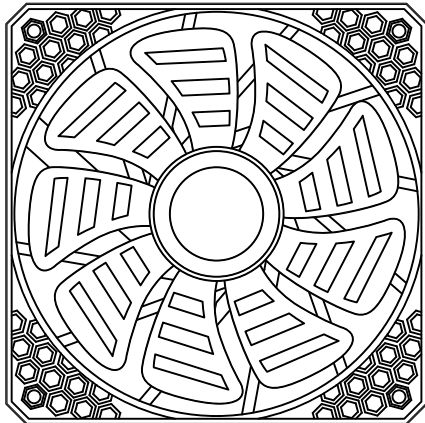

Spectre Pro RGB

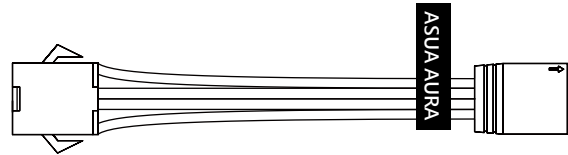

Connect to RGB LED connector on motherboard

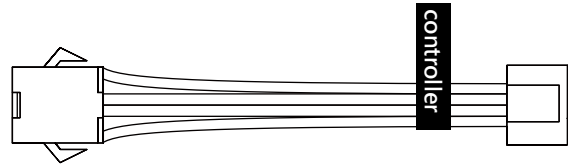

Connect to control board on BitFenix cases

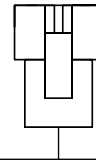

**Connect to control board
on BitFenix cases or RGB
LED connector on
motherboard**

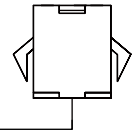

**Daisy chain with Bitfenix
RGB accessories**

■ Connect to control box

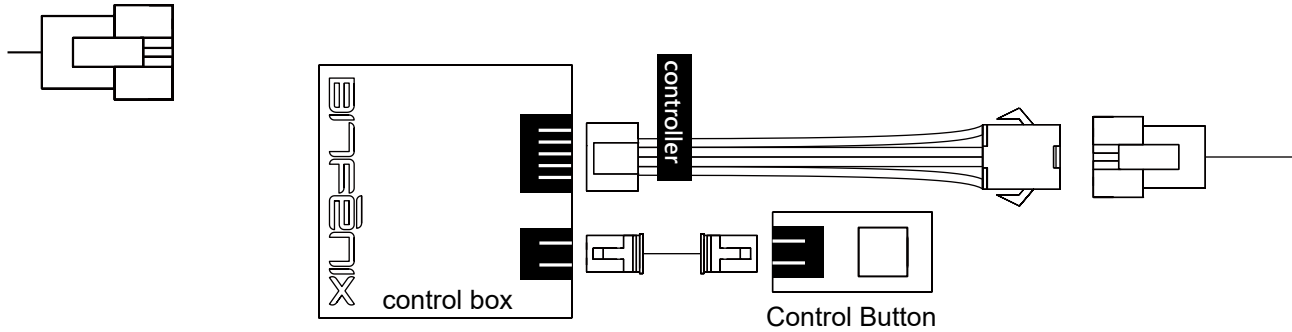

■ Connect to control board on BitFenix cases

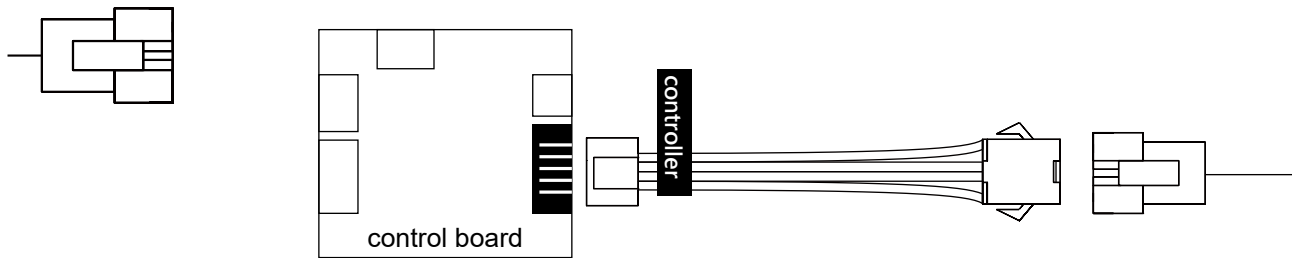

■ Daisy chain with BitFenix RGB accessories

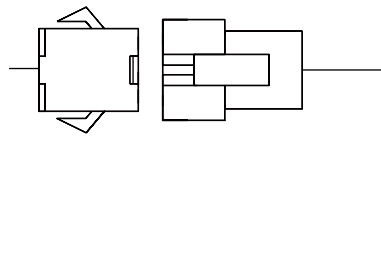

BitFenix RGB accessories

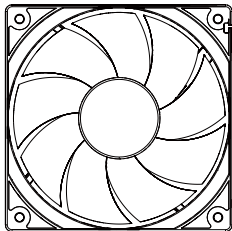

Spectre Pro RGB

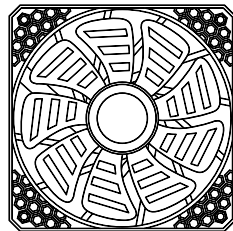

Spectre RGB



RGB LED strip

■ Connect to motherboard

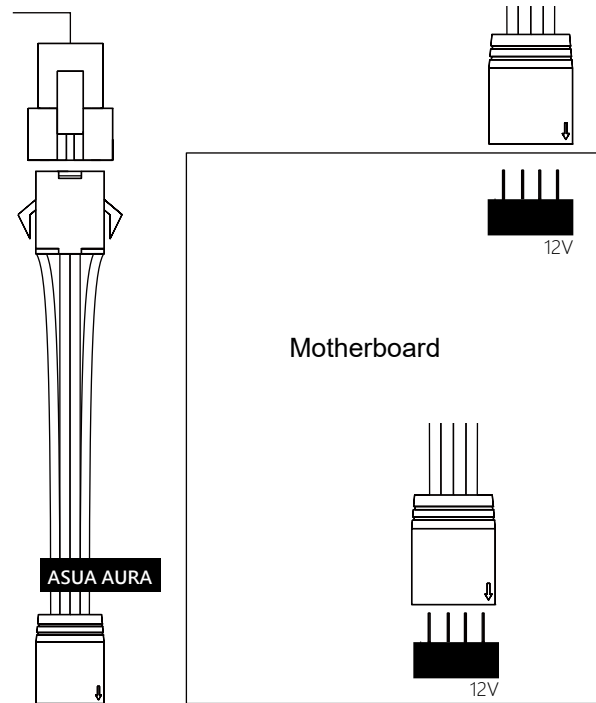

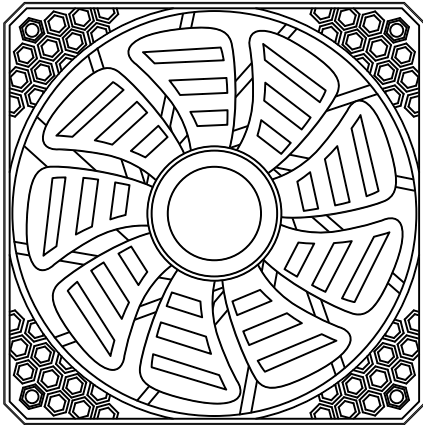

Spectre Pro RGB

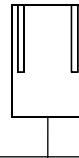

**Connect to fan header
on motherboard for
power**

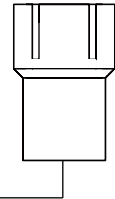

**Daisy chain with BitFenix
RGB accessories for power**

■ Connect to fan header on Motherboard

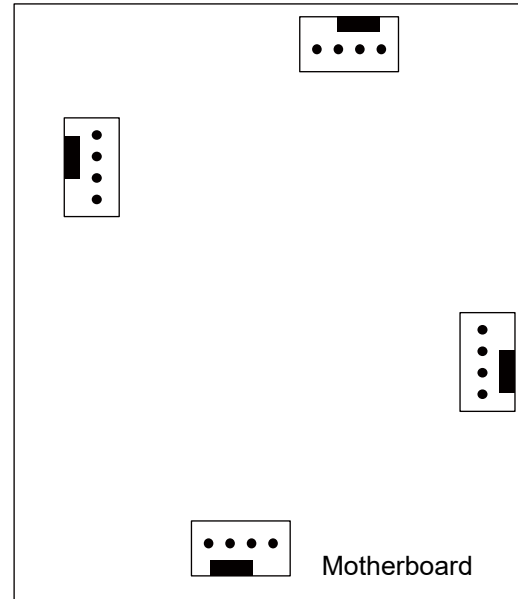
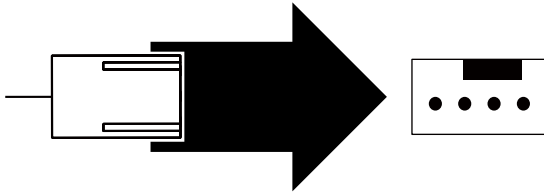

■ Daisy chain with BitFenix RGB accessories

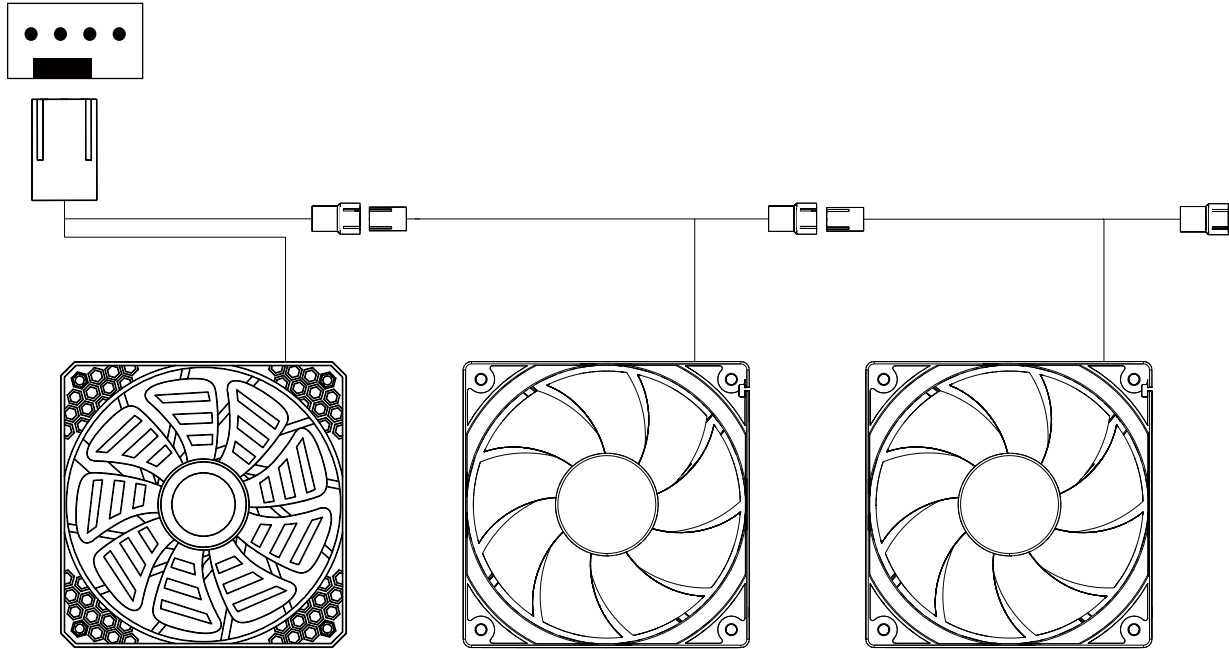

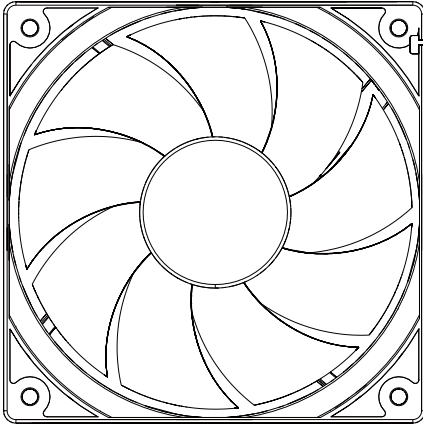

Spectre RGB

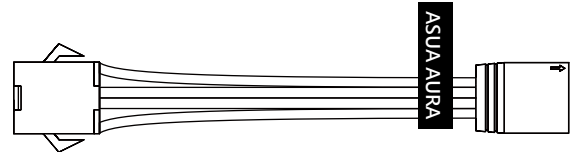

Connect to RGB LED connector on motherboard

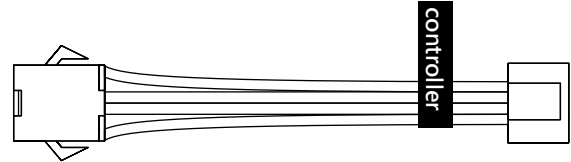

Connect to control board on BitFenix cases

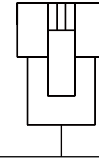

Connect to control board on BitFenix cases or RGB LED connector on motherboard

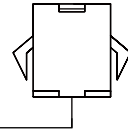

Daisy chain with BitFenix RGB accessories

■ Connect to control box

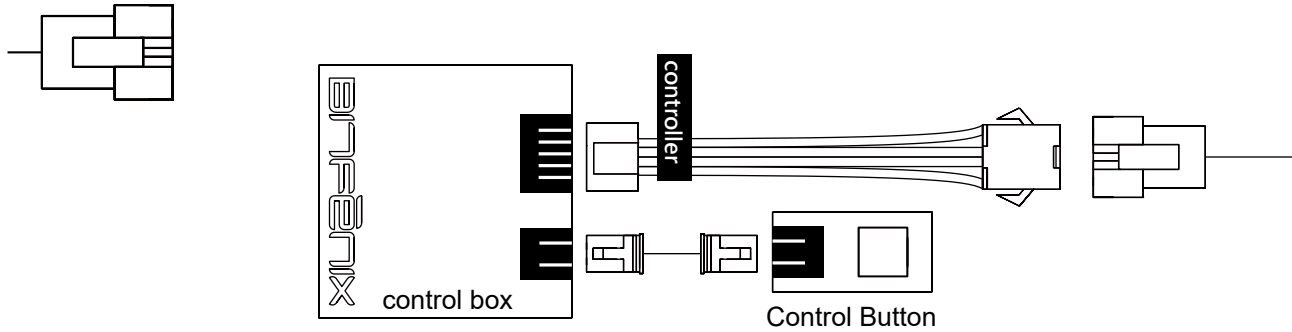

■ Connect to control board on BitFenix cases

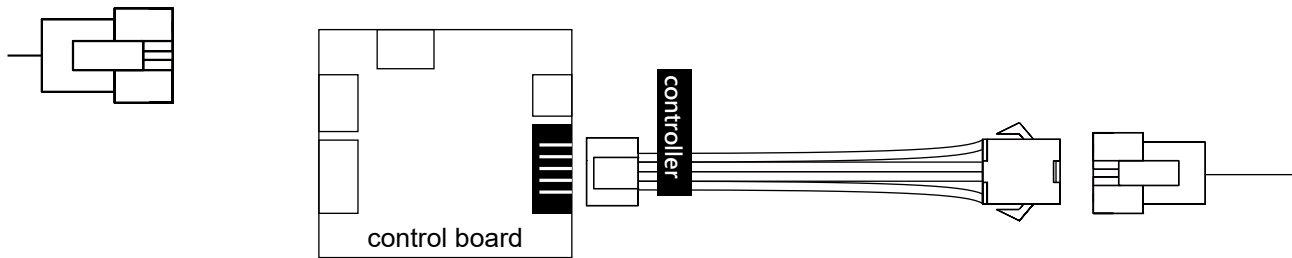

Daisy chain with BitFenix RGB accessories

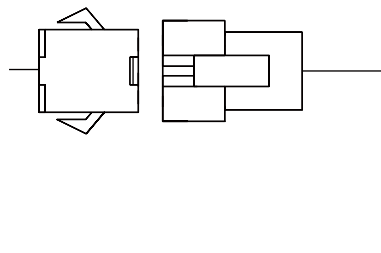

BitFenix RGB accessories

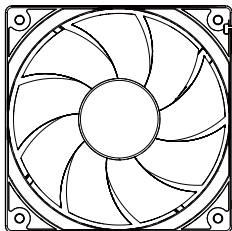

Spectre Pro RGB

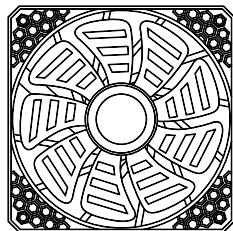

Spectre RGB



RGB LED strip

Connect to motherboard

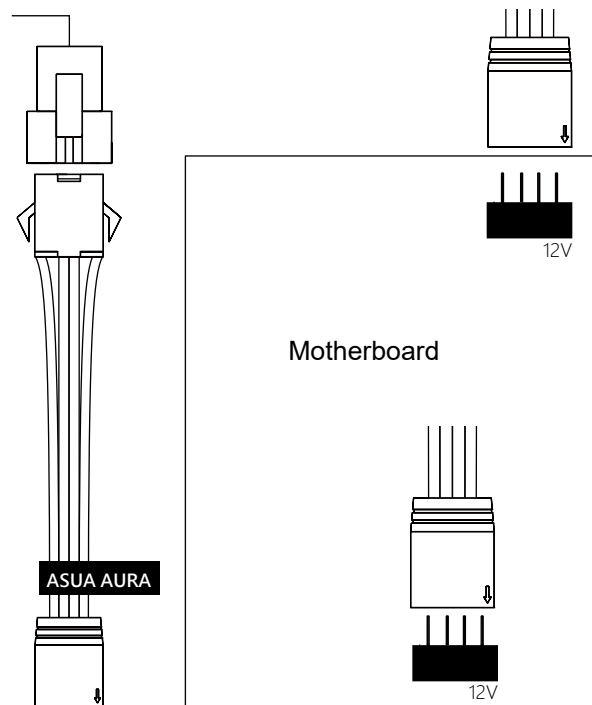

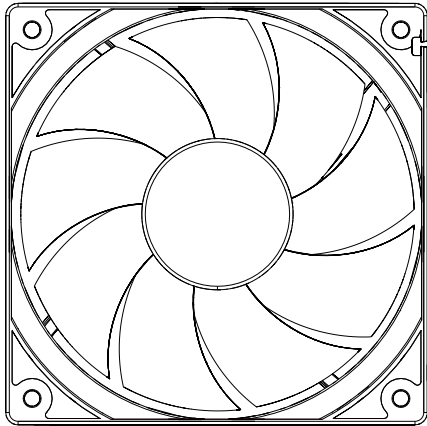

Spectre Pro RGB

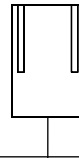

**Connect to fan header
on motherboard for
power**

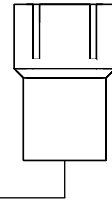

**Daisy chain with BitFenix
RGB accessories for power**

■ Connect to fan header on Motherboard

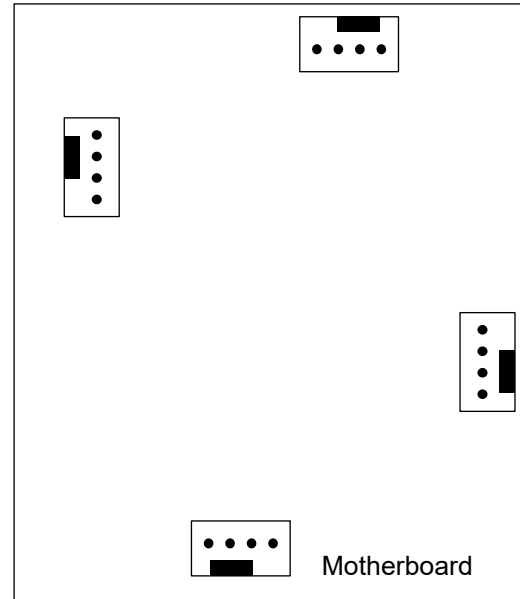
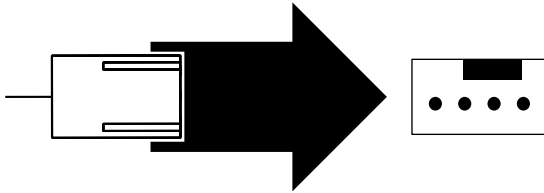

■ Daisy chain with BitFenix RGB accessories

