

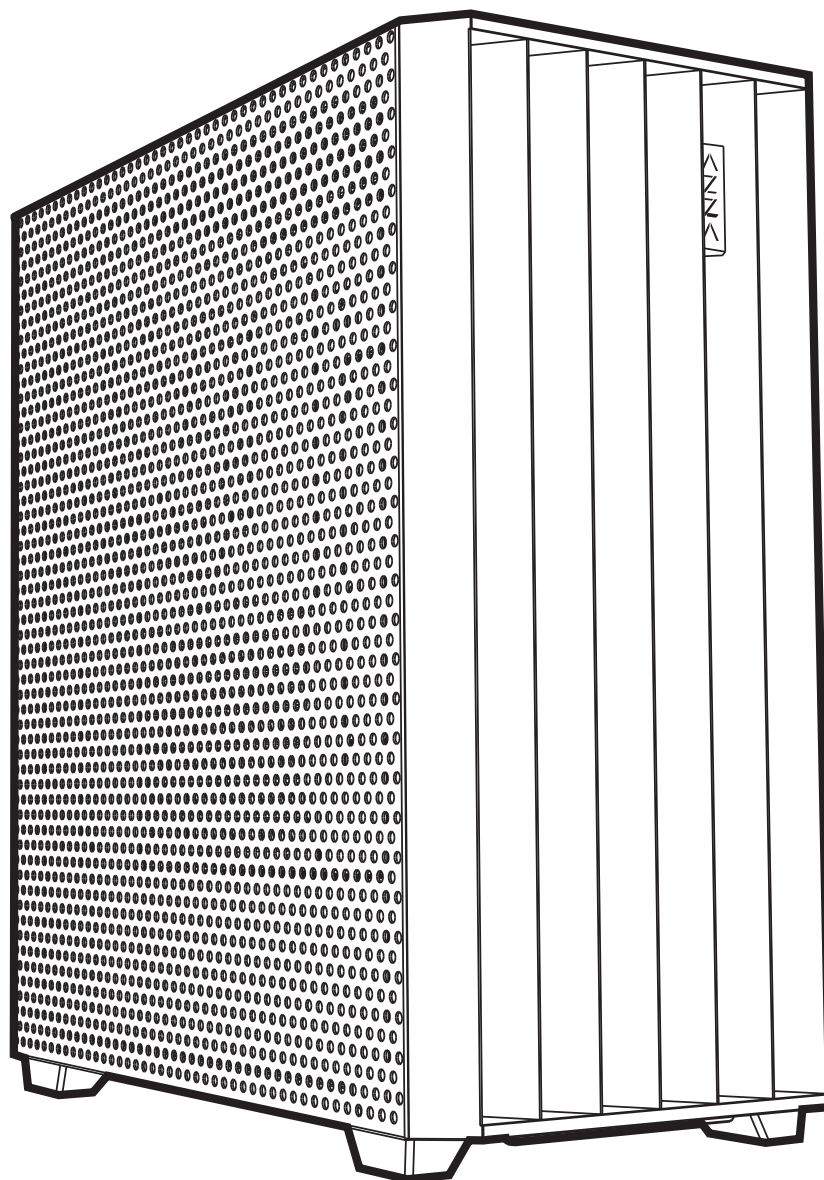

LEGIONNAIRE

Gaming case



USER MANUAL

1. Specifications
2. Chassis Parts
3. Control Panel Functions
4. 3.5"/2.5" HDD/SSD Installation
5. Remove the Front Panel Instructions
6. Cooling System Installation
7. Master Fan & Sub-fan Installation
8. PSU Fans Installation
9. Fan Installation
10. RGB Lighting Switching

Specifications

Model	
Model Name:	Legionaire
Model Number:	CSAZ-470
Specifications	
Type:	ATX Mid Tower
Color:	Black/Black(interior)
Side Panel Window:	Left side panel:slidable iron mesh side panel
Max CPU Cooler Height:	UP to 170 mm
Max Video Card Length:	Up to 400 mm long video card
Power Supply:	Not included
Motherboard Compatibility:	E-ATX 、 ATX 、 Micro ATX 、 ITX
Expansion	
External 5.25" Drive Bays:	0
Internal 2.5" Drive Bays:	Up to 4
Internal 3.5" Drive Bays:	Up to 2
Expansion Slots:	7
Top Ports:	Power button, LED button, HD Audio, USB 3.0 x 2
Physical Specifications	
Case Dimension (HxWxD)	483x220x440mm/19x8.7x17.3 inches
Weight:	6.1Kg /13.5lbs
Features	
Mesh side panel:	The full mesh side windows allow for clear visuals to inner components and increased air intake, having maximum airflow performance.
Addressable RGB Light Effects:	ARGB fans are controlled using the LED button. All addressable RGB devices can sync with the motherboard,allowing the motherboard software to control lighting directly.
Available Fan Ports:	3x120mm or 3x140mm fan ports in the front (3x120mm LFO-3812D addressable ARGB fan included) 3x120mm or 2x140mm fan ports on the top 1x120mm fan port in the rear (1x120mm LFO-3812D addressable ARGB PWM fan included) 2x120mm fan ports on the Power Supply Shroud
Water Cooling:	Supports radiators up to 280/360mm in the front Supports radiators up to 240/280mm in the top
Dust Filters:	Removable (magnetic) dustproof net on the top, dust filter on bottom of chassis.
Power Supply Support:	Bottom mounted ATX Power Supply

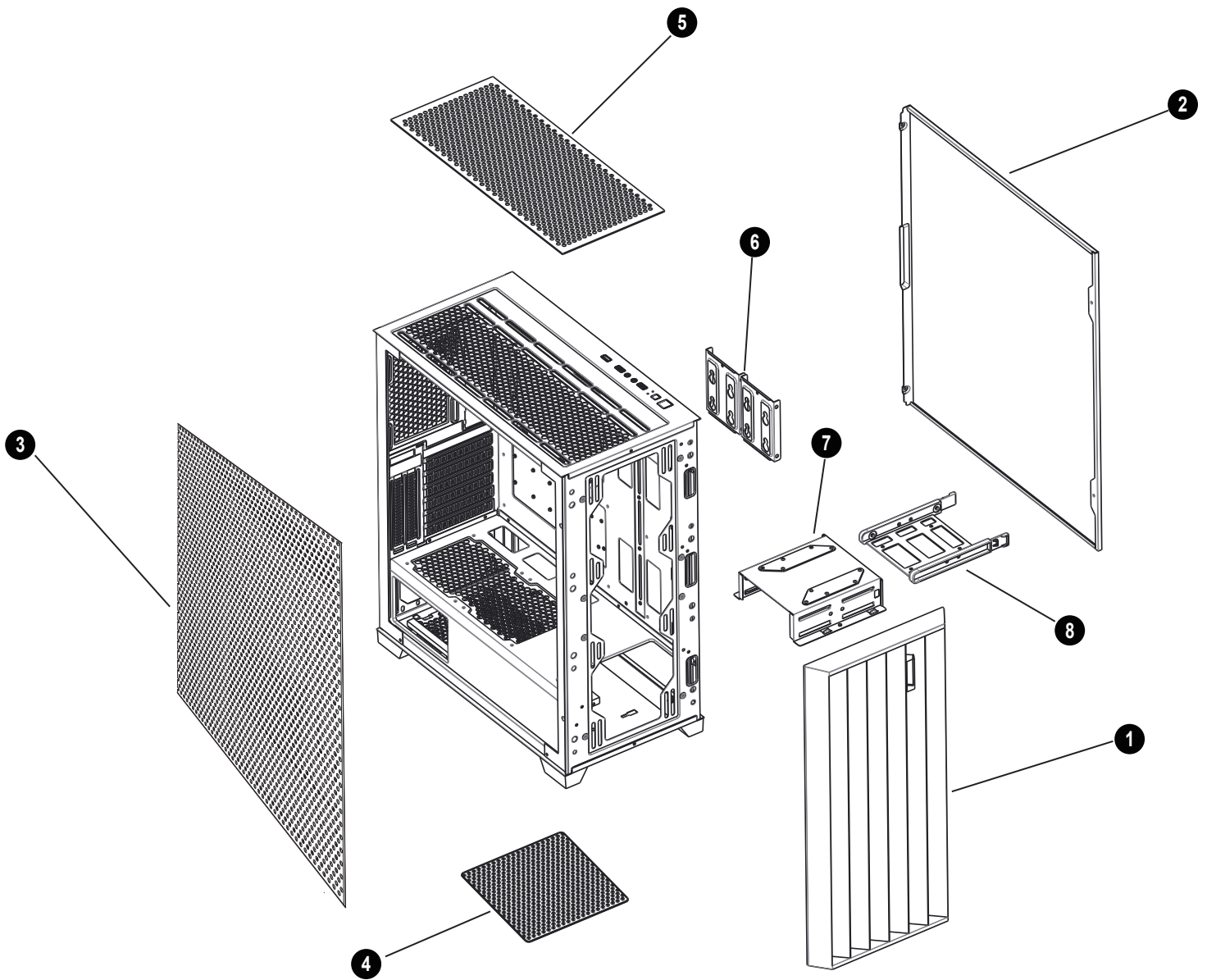

Chassis Parts



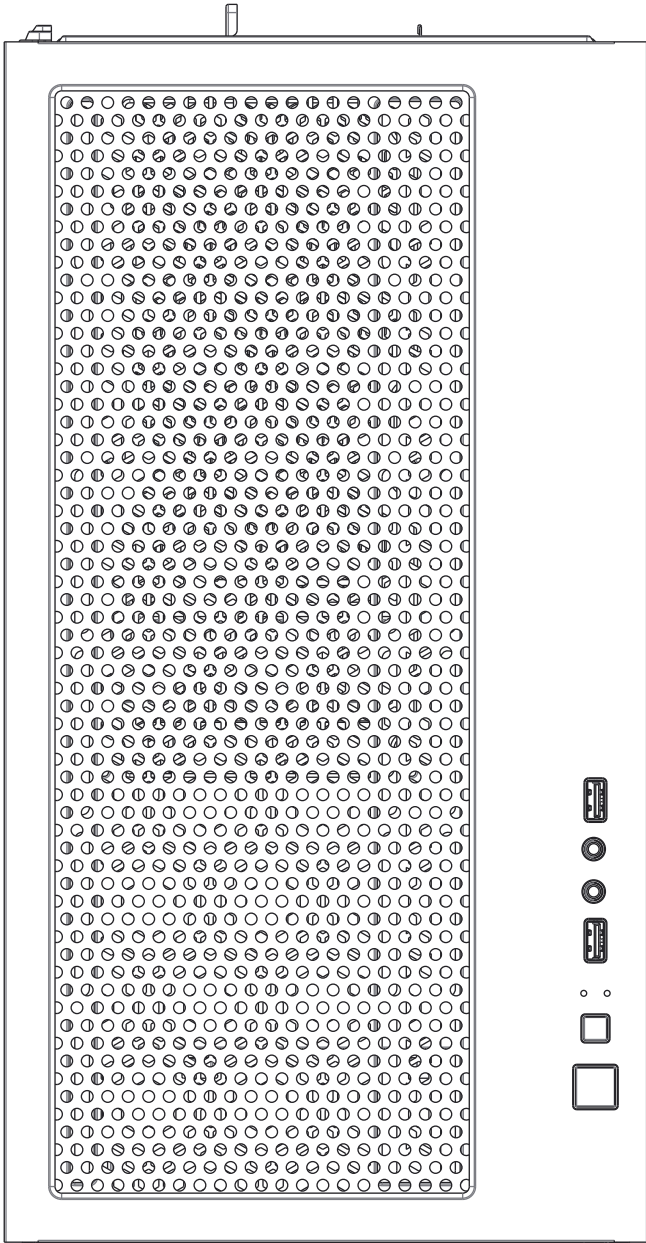

1	Front panel
2	Metal side panel
3	Mesh side panel
4	Removable dust filter
5	Removable magnetic mesh
6	2.5" SSD tray x 2
7	Hard disk cage
8	3.5" HDD/ 2.5" SSD brackets

Control Panel Functions



	POWER
	LED
	Mic
	Audio

	USB 3.0
	USB 3.0

3.5" / 2.5" HDD/SSD Installation

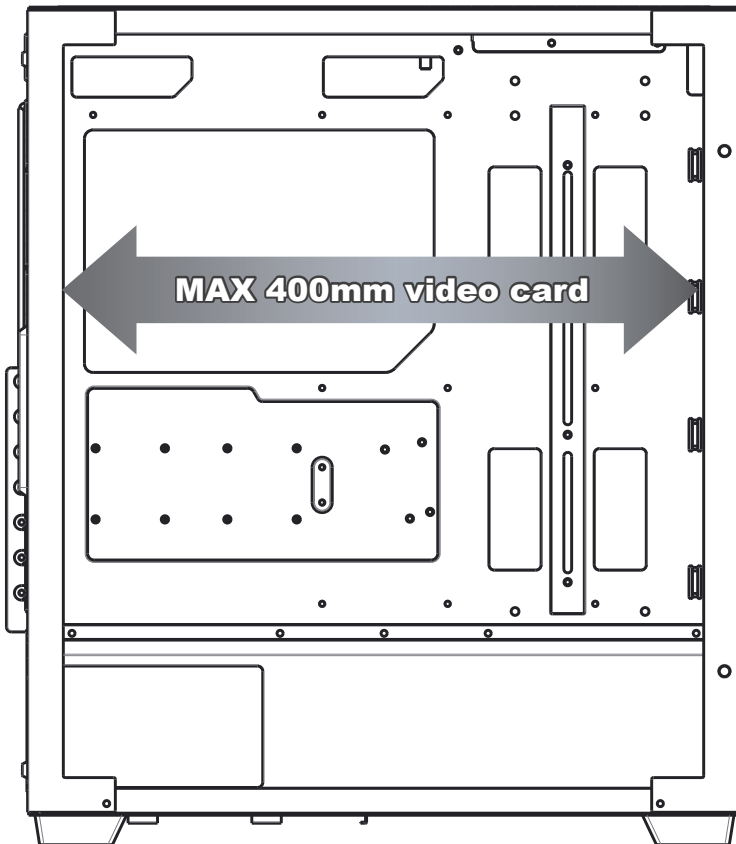

- Supports up to 400mm long video cards.



or

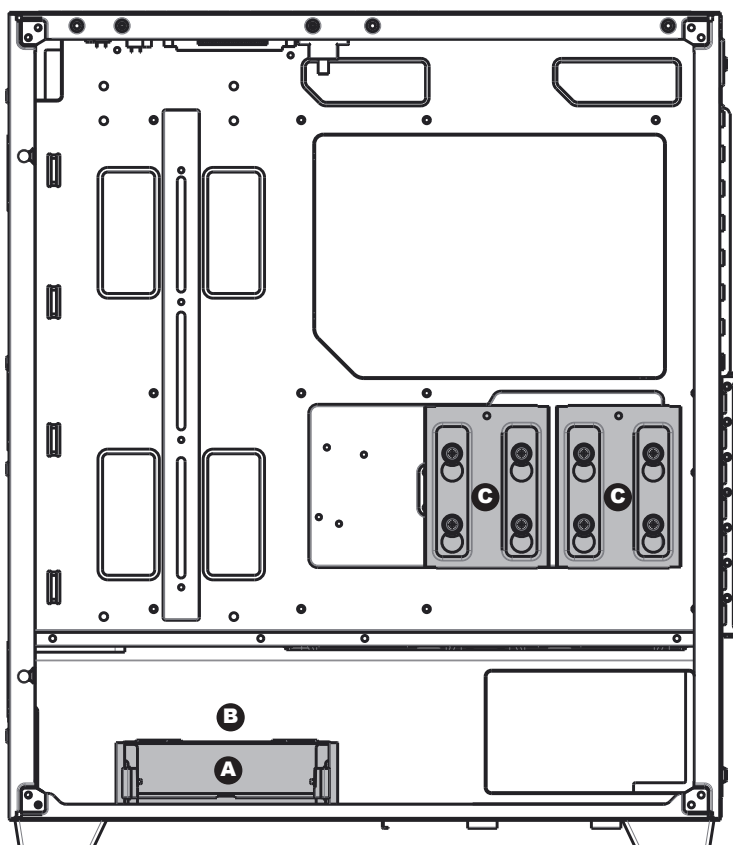

- Multifunctional hard disk bracket support
3.5" HDD or 2.5" SSD x 1 (**A**)
- Multifunctional hard disk bracket support
2.5" SSD x 2 (**C**)
- Multifunctional hard disk cage support
3.5" HDD or 2.5" SSD x 1 (**B**)

Remove the Front Panel Instructions

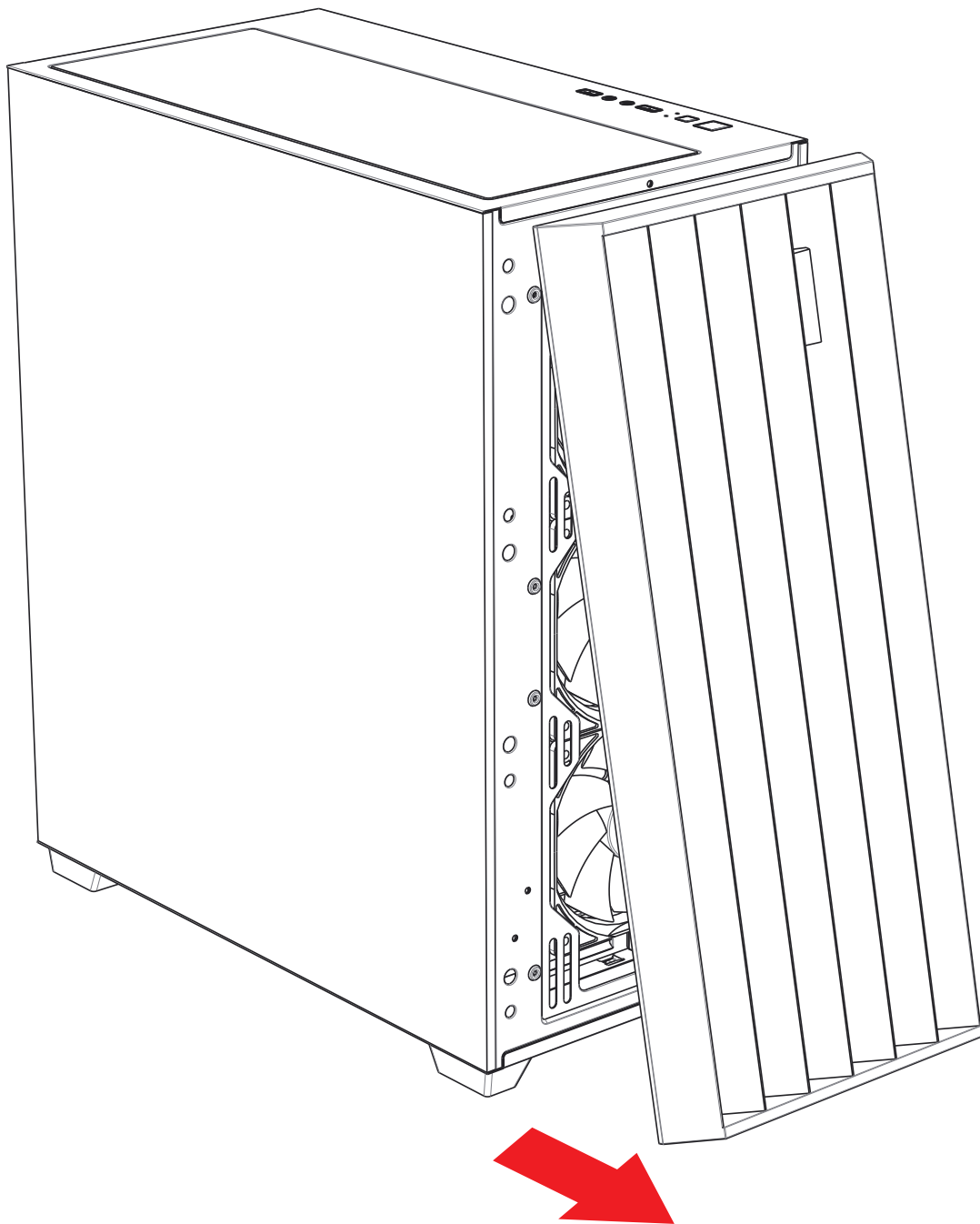

Front

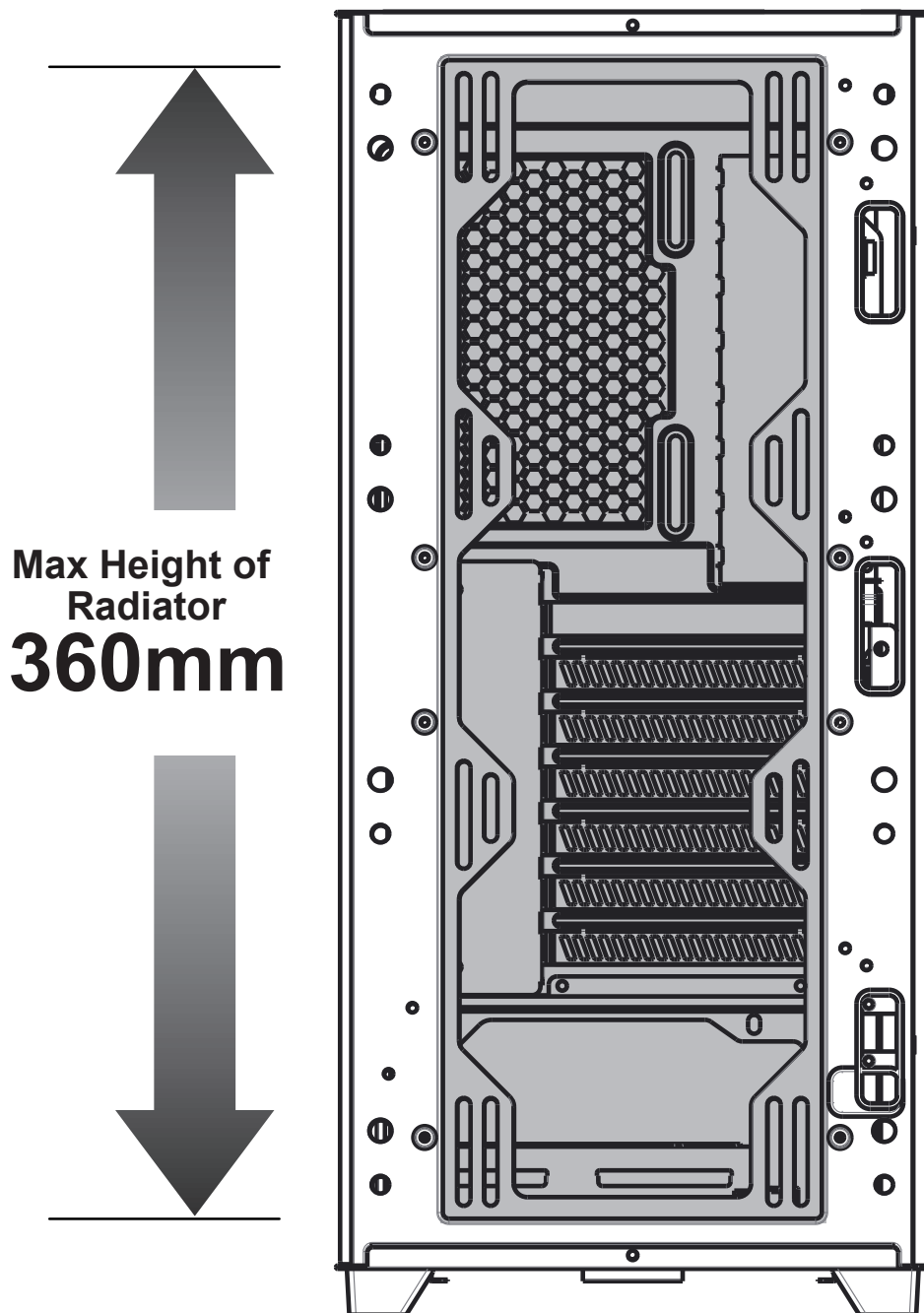

Max Height of
Radiator
360mm

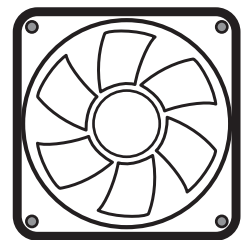

120mm x3

or

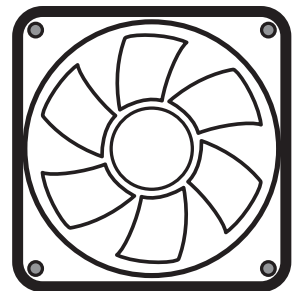

140mm x3

Top

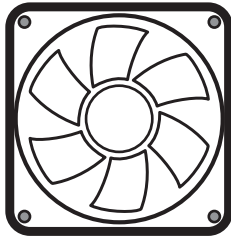

120mm x3

or

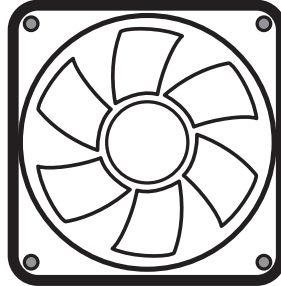

140mm x2

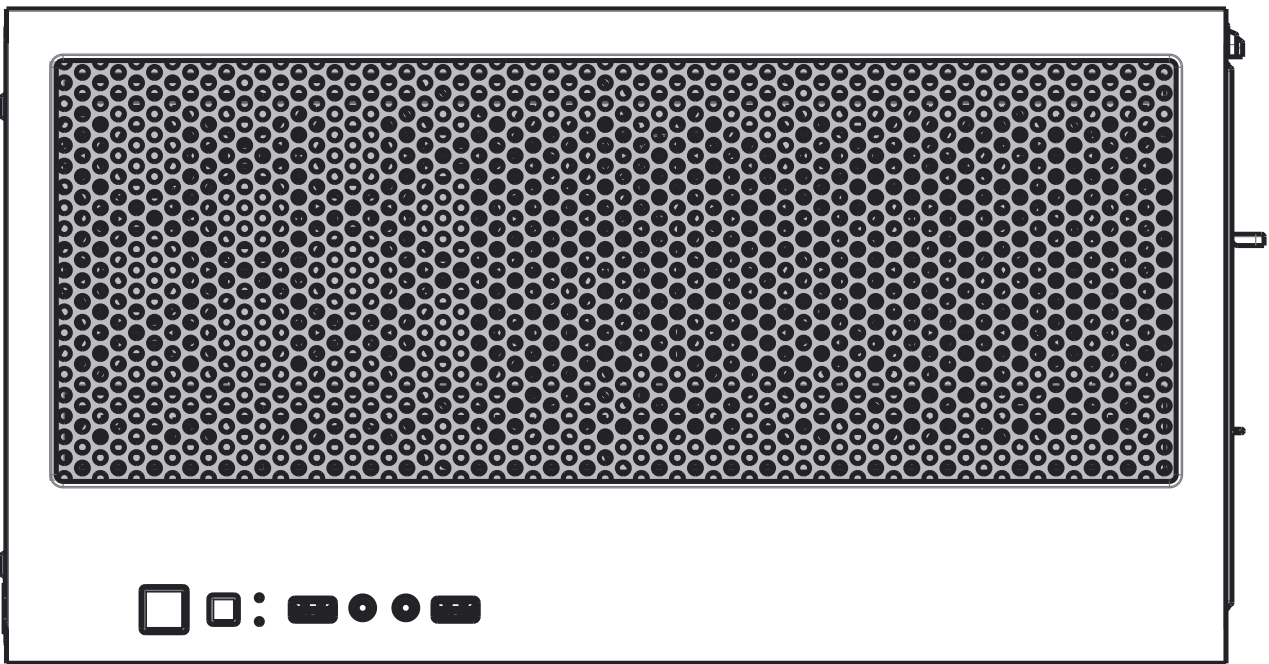

Rear

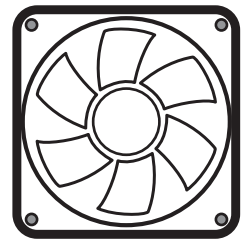
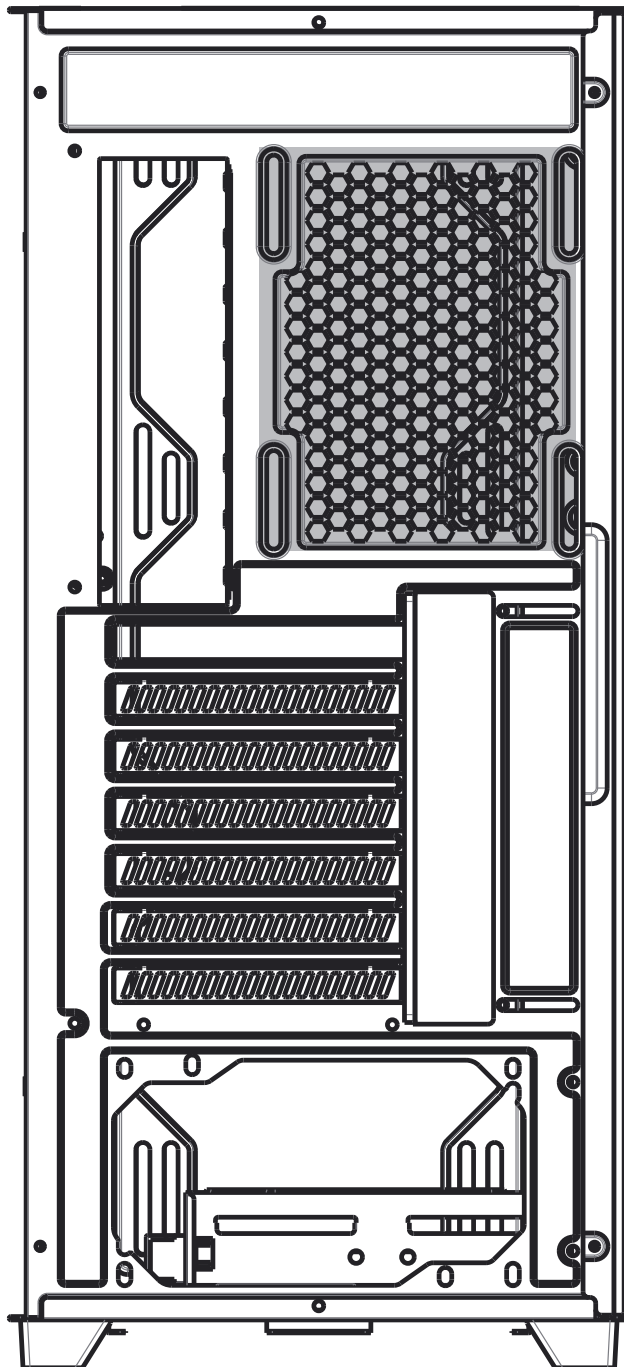

120mm x1

Master Fan & Sub-fan Installation

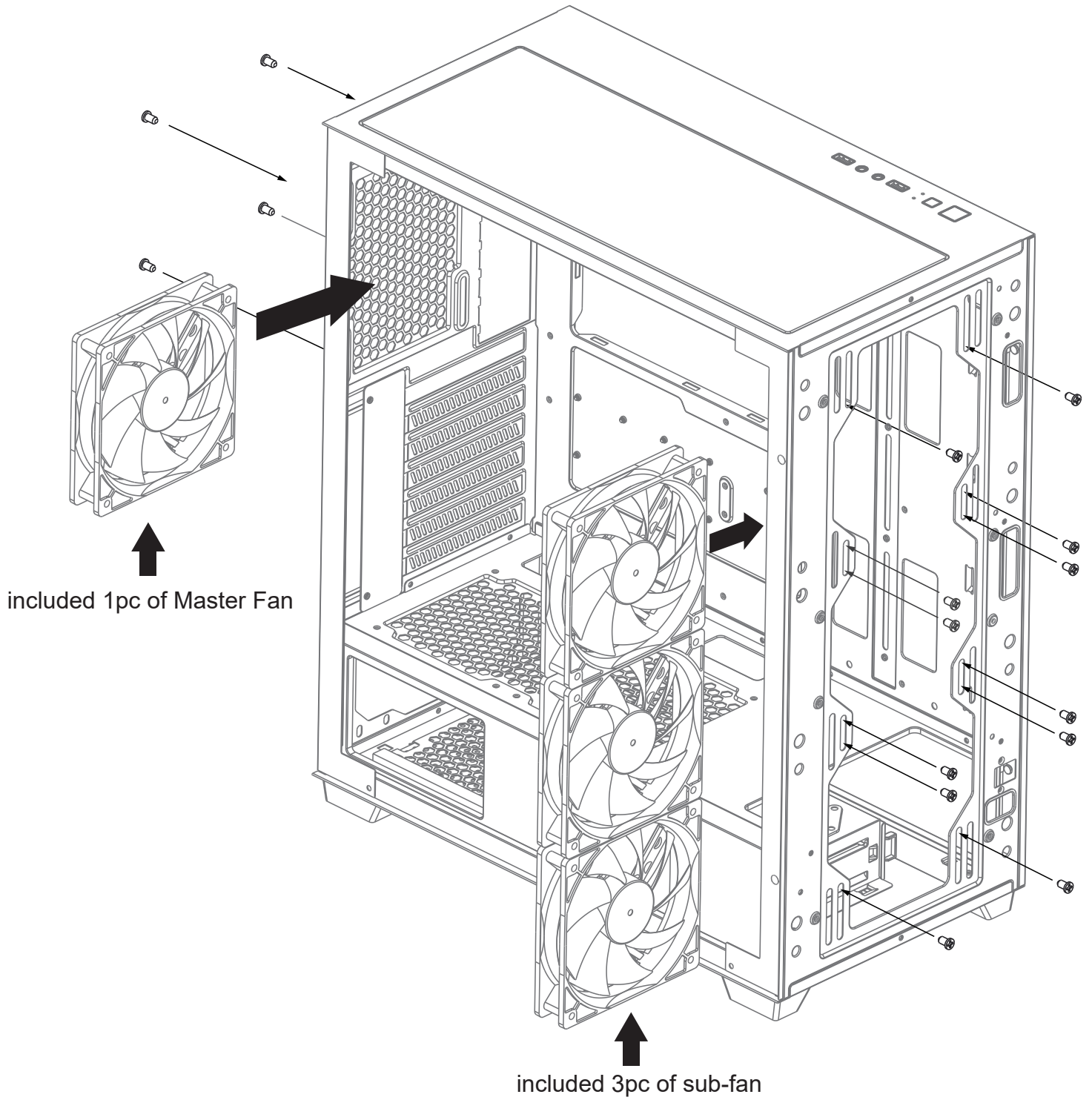

PSU Fans Installation

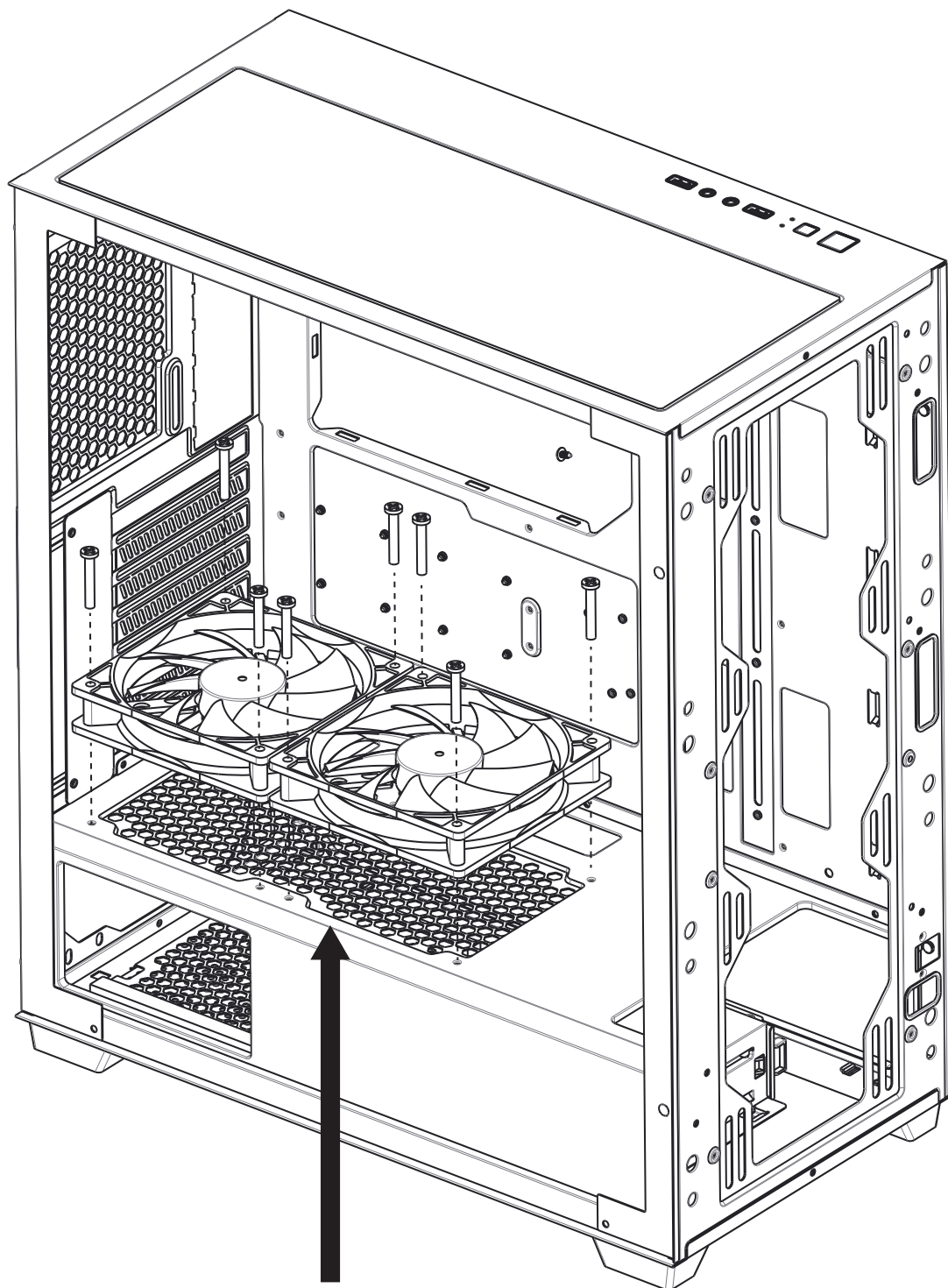

2x120mm fan ports on the Power Supply Shroud

Fan Installation

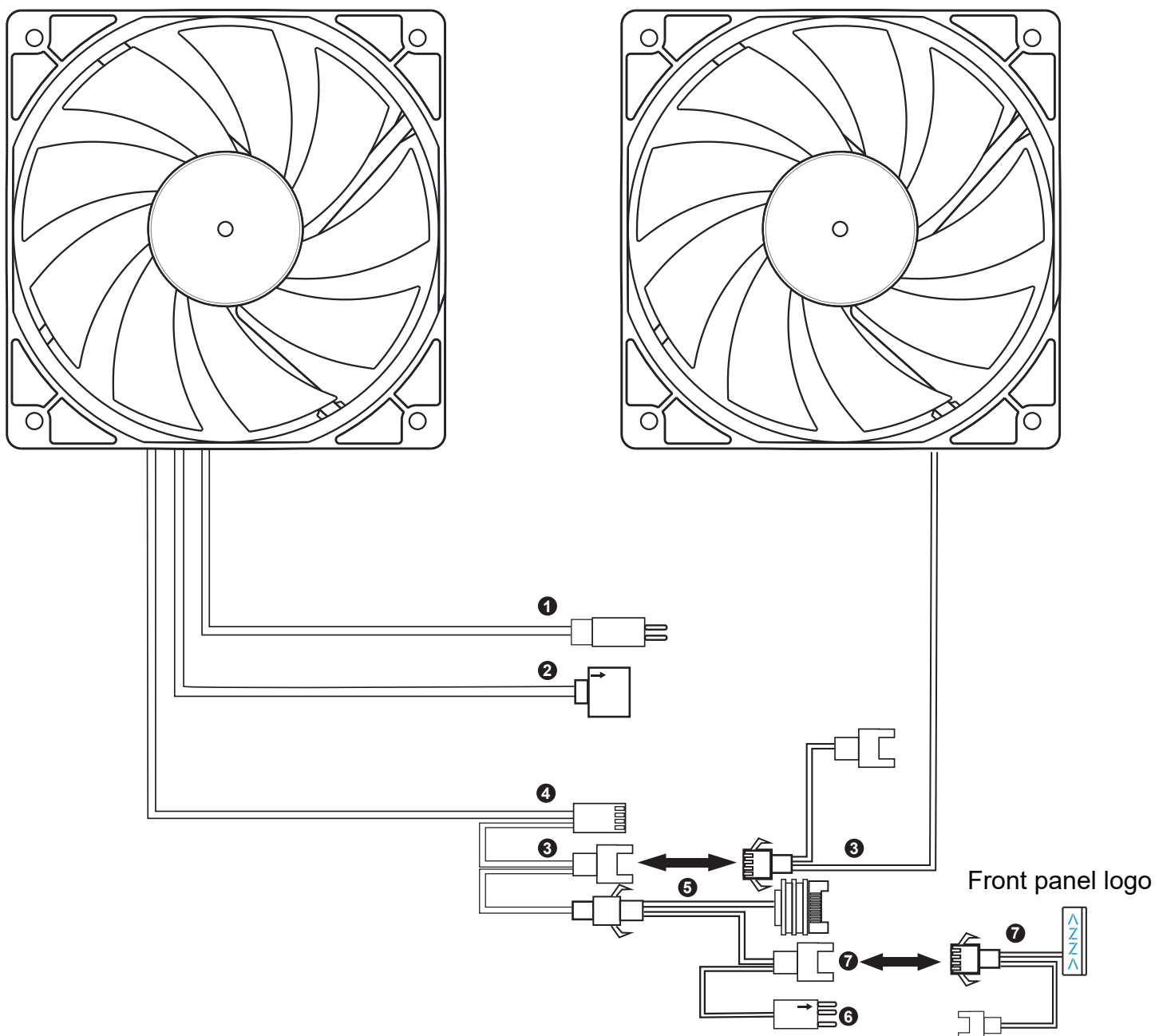

	CONNECTOR	CONNECTION
①	Reset (LED) S/W (2pin)	LED Button
②	ARGB LED 5V (3pin) female connector	The 5V/3pin ARGB socket of the motherboard
③	Fan Connector	The master Fan connect to the sub-fan
④	Fan Connector PWM (4pin)	CHA_FANx socket of the motherboard
⑤	SATA	Power Supply
⑥	ARGB LED 5V (3pin) male connector	Other 5V/3pin ARGB devices
⑦	Logo ARGB LED connector	The last sub-fan female connector

※ Before the fan starts, please make sure the PWM connector ④ and SATA connector ⑤ each are connected.

※ Press the LED button to cycle through different RGB lighting modes, all ARGB devices are controlled by the LED button. (make sure the other 3pin ARGB devices are connected with ⑥)

※ Ensure ② insert the motherboard, hold the LED button for 3 seconds to switch the RGB control function between motherboard RGB software and LED button.

RGB Lighting Switching

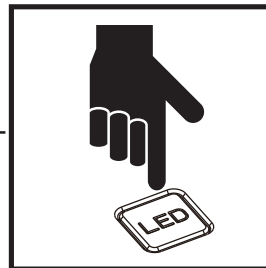
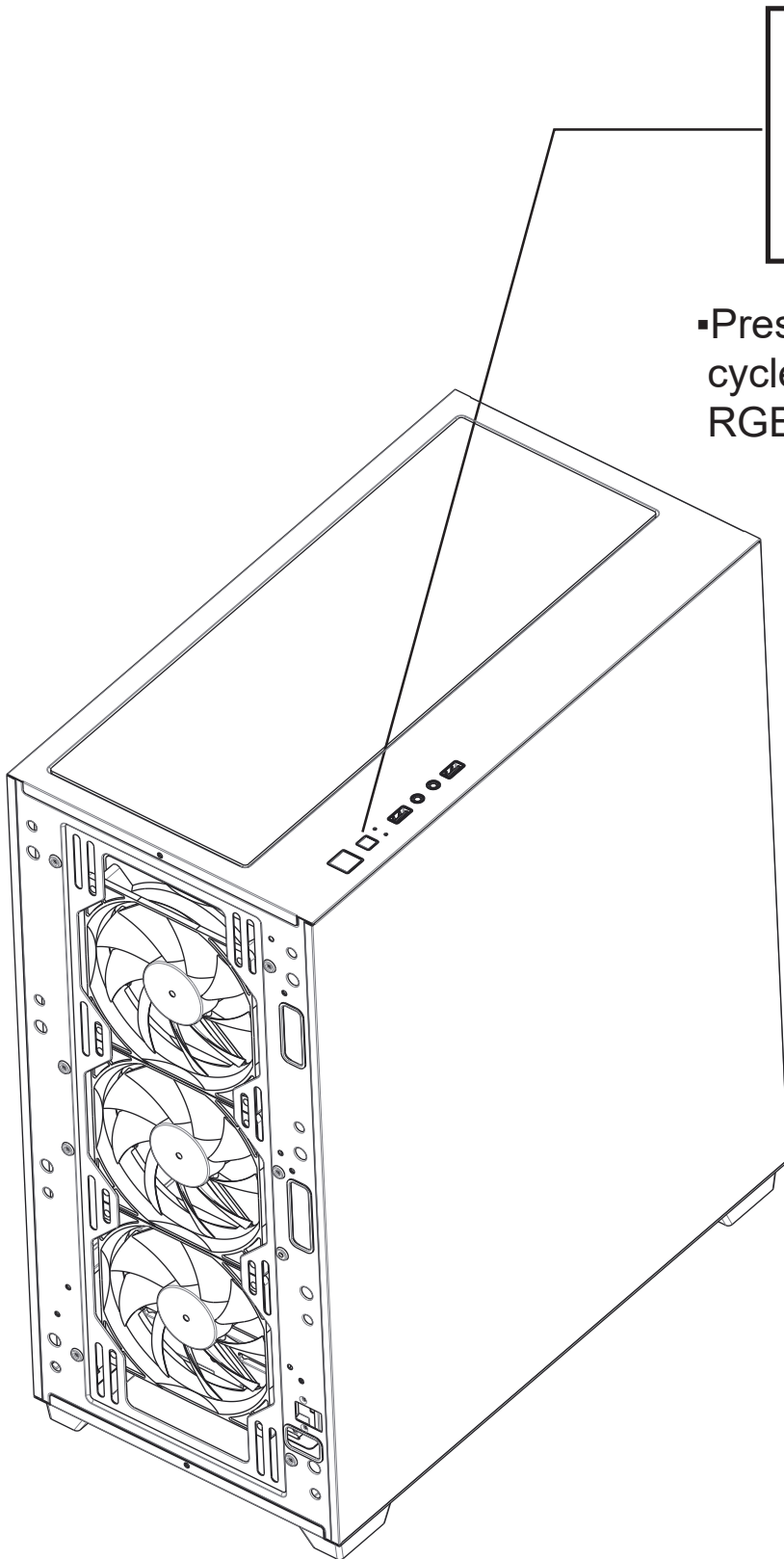

- Press the LED button to cycle through different RGB lighting modes.