



FOR THOSE WHO DARE
JOIN
REPUBLIC OF GAMERS
THE WORLD
ROG
REPUBLIC OF GAMERS
ROG
REPUBLIC OF GAMERS

ROG SWIFT PG32UQR

USER GUIDE

First Edition

May 2023

Copyright © 2023 ASUSTeK COMPUTER INC. All Rights Reserved.

No part of this manual, including the products and software described in it, may be reproduced, transmitted, transcribed, stored in a retrieval system, or translated into any language in any form or by any means, except documentation kept by the purchaser for backup purposes, without the express written permission of ASUSTeK COMPUTER INC. ("ASUS").

Product warranty or service will not be extended if: (1) the product is repaired, modified or altered, unless such repair, modification or alteration is authorized in writing by ASUS; or (2) the serial number of the product is defaced or missing.

ASUS PROVIDES THIS MANUAL "AS IS" WITHOUT WARRANTY OF ANY KIND, EITHER EXPRESS OR IMPLIED, INCLUDING BUT NOT LIMITED TO THE IMPLIED WARRANTIES OR CONDITIONS OF MERCHANTABILITY OR FITNESS FOR A PARTICULAR PURPOSE. IN NO EVENT SHALL ASUS, ITS DIRECTORS, OFFICERS, EMPLOYEES OR AGENTS BE LIABLE FOR ANY INDIRECT, SPECIAL, INCIDENTAL, OR CONSEQUENTIAL DAMAGES (INCLUDING DAMAGES FOR LOSS OF PROFITS, LOSS OF BUSINESS, LOSS OF USE OR DATA, INTERRUPTION OF BUSINESS AND THE LIKE), EVEN IF ASUS HAS BEEN ADVISED OF THE POSSIBILITY OF SUCH DAMAGES ARISING FROM ANY DEFECT OR ERROR IN THIS MANUAL OR PRODUCT.

SPECIFICATIONS AND INFORMATION CONTAINED IN THIS MANUAL ARE FURNISHED FOR INFORMATIONAL USE ONLY, AND ARE SUBJECT TO CHANGE AT ANY TIME WITHOUT NOTICE, AND SHOULD NOT BE CONSTRUED AS A COMMITMENT BY ASUS. ASUS ASSUMES NO RESPONSIBILITY OR LIABILITY FOR ANY ERRORS OR INACCURACIES THAT MAY APPEAR IN THIS MANUAL, INCLUDING THE PRODUCTS AND SOFTWARE DESCRIBED IN IT.

Products and corporate names appearing in this manual may or may not be registered trademarks or copyrights of their respective companies, and are used only for identification or explanation and to the owners' benefit, without intent to infringe.

Contents

Contents	iii
Notices	iv
Safety information	v
Care & Cleaning	vi
Takeback Services	vii
Product information for EU energy label	vii
Chapter 1: Product introduction	
1.1 Welcome!	1-1
1.2 Package contents	1-1
1.3 Monitor introduction	1-2
1.3.1 Front view	1-2
1.3.2 Back view	1-3
1.3.3 GamePlus function	1-4
1.3.4 GameVisual function	1-6
1.3.5 Other Function(s)	1-7
Chapter 2: Setup	
2.1 Attaching the arm/base	2-1
2.2 Cable management	2-2
2.3 Detaching the arm/base (for VESA wall mount)	2-3
2.4 Adjusting the monitor	2-4
2.5 Connecting the cables	2-5
2.6 Turning on/off the monitor	2-6
Chapter 3: General instructions	
3.1 OSD (On-Screen Display) menu	3-1
3.1.1 How to reconfigure	3-1
3.1.2 OSD function introduction	3-2
3.2 Aura	3-10
3.3 Specifications summary	3-11
3.4 Outline dimensions	3-13
3.5 Troubleshooting (FAQ)	3-14
3.6 Supported operating modes	3-15

Notices

Federal Communications Commission Statement

This device complies with Part 15 of the FCC Rules. Operation is subject to the following two conditions:

- This device may not cause harmful interference, and
- This device must accept any interference received including interference that may cause undesired operation.

This equipment has been tested and found to comply with the limits for a Class B digital device, pursuant to Part 15 of the FCC Rules. These limits are designed to provide reasonable protection against harmful interference in a residential installation. This equipment generates, uses and can radiate radio frequency energy and, if not installed and used in accordance with the instructions, may cause harmful interference to radio communications. However, there is no guarantee that interference will not occur in a particular installation. If this equipment does cause harmful interference to radio or television reception, which can be determined by turning the equipment off and on, the user is encouraged to try to correct the interference by one or more of the following measures:

- Reorient or relocate the receiving antenna.
- Increase the separation between the equipment and receiver.
- Connect the equipment into an outlet on a circuit different from that to which the receiver is connected.
- Consult the dealer or an experienced radio/TV technician for help.



The use of shielded cables for connection of the monitor to the graphics card is required to assure compliance with FCC regulations. Changes or modifications to this unit not expressly approved by the party responsible for compliance could void the user's authority to operate this equipment.

Canadian Department of Communications Statement

This digital apparatus does not exceed the Class B limits for radio noise emissions from digital apparatus set out in the Radio Interference Regulations of the Canadian Department of Communications.

This class B digital apparatus complies with Canadian ICES-003.

This Class B digital apparatus meets all requirements of the Canadian Interference - Causing Equipment Regulations.

Cet appareil numérique de la classe B respecte toutes les exigences du Règlement sur le matériel brouiller du Canada.



Safety information

- Before setting up the monitor, carefully read all the documentation that came with the package.
- To prevent fire or shock hazard, never expose the monitor to rain or moisture.
- Never try to open the monitor cabinet. The dangerous high voltages inside the monitor may result in serious physical injury.
- If the power supply is broken, do not try to fix it by yourself. Contact a qualified service technician or your retailer.
- Before using the product, make sure all cables are correctly connected and the power cables are not damaged. If you detect any damage, contact your dealer immediately.
- Slots and openings on the back or top of the cabinet are provided for ventilation. Do not block these slots. Never place this product near or over a radiator or heat source unless proper ventilation is provided.
- The monitor should be operated only from the type of power source indicated on the label. If you are not sure of the type of power supply to your home, consult your dealer or local power company.
- Use the appropriate power plug which complies with your local power standard.
- Do not overload power strips and extension cords. Overloading can result in fire or electric shock.
- Avoid dust, humidity, and temperature extremes. Do not place the monitor in any area where it may become wet. Place the monitor on a stable surface.
- Unplug the unit during a lightning storm or if it will not be used for a long period of time. This will protect the monitor from damage due to power surges.
- Never push objects or spill liquid of any kind into the slots on the monitor cabinet.
- To ensure satisfactory operation, use the monitor only with UL listed computers which have appropriate configured receptacles marked between 100-240V AC.
- If you encounter technical problems with the monitor, contact a qualified service technician or your retailer.
- Adjustment of the volume control as well as the equalizer to other settings than the center position may increase the ear-/headphones output voltage and therefore the sound pressure level.
- The adapter is only used for this monitor, do not use it for other purpose. Your device uses one of the following power supplies:
 - Manufacturer: Delta Electronics Inc., Model: ADP-240EB B
- Ensure to connect the power cord to a socket-outlet with earthing connection.
- The supplied power adapter and/or power cable are designed to use with the product only. Do not use with other products.



This symbol of the crossed out wheeled bin indicates that the product (electrical, electronic equipment, and mercury-containing button cell battery) should not be placed in municipal waste. Please check local regulations for disposal of electronic products.

AEEE yönetmeliğine uygundur

Care & Cleaning

- Before you lift or reposition your monitor, it is better to disconnect the cables and power cord. Follow the correct lifting techniques when positioning the monitor. When lifting or carrying the monitor, grasp the edges of the monitor. Do not lift the display by the stand or the cord.
- Cleaning. Turn your monitor off and unplug the power cord. Clean the monitor surface with a lint-free, non-abrasive cloth. Stubborn stains may be removed with a cloth dampened with mild cleaner.
- Avoid using a cleaner containing alcohol or acetone. Use a cleaner intended for use with the monitor. Never spray cleaner directly on the screen, as it may drip inside the monitor and cause an electric shock.

The following symptoms are normal with the monitor:

- You may find slightly uneven brightness on the screen depending on the desktop pattern you use.
- When the same image is displayed for hours, an afterimage of the previous screen may remain after switching the image. The screen will recover slowly or you can turn off the Power Switch for hours.
- When the screen becomes black or flashes, or cannot work anymore, contact your dealer or service center to fix it. Do not repair the screen by yourself!

Conventions used in this guide



WARNING: Information to prevent injury to yourself when trying to complete a task.



CAUTION: Information to prevent damage to the components when trying to complete a task.



IMPORTANT: Information that you **MUST** follow to complete a task.



NOTE: Tips and additional information to aid in completing a task.

Where to find more information

Refer to the following sources for additional information and for product and software updates.

1. ASUS websites

The ASUS websites worldwide provide updated information on ASUS hardware and software products. Refer to <http://www.asus.com>

2. Optional documentation

Your product package may include optional documentation that may have been added by your dealer. These documents are not part of the standard package.

3. About Flicker

https://www.asus.com/Microsite/display/eye_care_technology/

Takeback Services

ASUS recycling and takeback programs come from our commitment to the highest standards for protecting our environment. We believe in providing solutions for our customers to be able to responsibly recycle our products, batteries and other components as well as the packaging materials.

Please go to <http://csr.asus.com/english/Takeback.htm> for detail recycling information in different region.

Product information for EU energy label



PG32UQXR

1.1 Welcome!

Thank you for purchasing the ASUS® LCD monitor!

The latest widescreen LCD monitor from ASUS provides a broader, brighter and crystal-clear display, plus a host of features that enhance your viewing experience.

With these features, you can enjoy the convenience and delightful visual experience that the monitor brings to you!

1.2 Package contents

Check your package for the following items:

- ✓ LCD monitor
- ✓ Monitor base
- ✓ Quick start guide
- ✓ Warranty card
- ✓ Power adapter
- ✓ Power cord
- ✓ HDMI cable
- ✓ DisplayPort cable
- ✓ USB cable
- ✓ ROG welcome card
- ✓ Color calibration testing report
- ✓ Input/Output port cover
- ✓ Wall-mount spacer screws
- ✓ Tripod screw
- ✓ ROG sticker
- ✓ ROG pouch
- ✓ Assembly tips



If any of the above items is damaged or missing, contact your retailer immediately.



If you need to replace the power cord or the connection cable(s), please contact ASUS customer service.

1.3 Monitor introduction

1.3.1 Front view

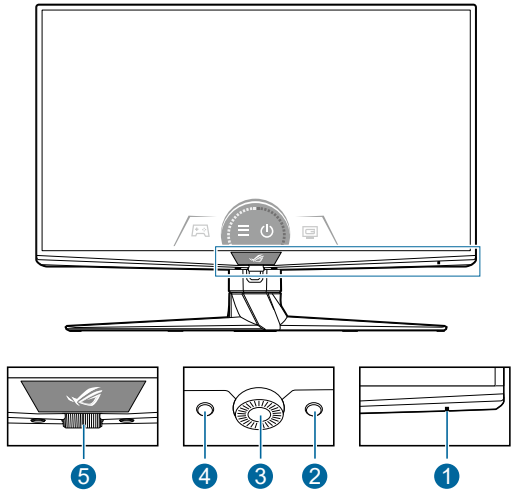

1. Power indicator

- The color definition of the power indicator is as the below table.

Status	Description
White	ON
OFF	OFF
Amber	Standby mode/No signal

2. Shortcut(Right)

- Turns on the monitor when the monitor enters standby mode or displays the “NO SIGNAL“ message.
- Default: GameVisual hotkey
- To change the hotkey function, go to the **MyFavorite > Shortcut > Shortcut(Right)** menu.

3. OK button:

- Turns on the monitor when the monitor enters standby mode or displays the “NO SIGNAL“ message.
- Press this button to enter the OSD menu.
- Enacts the selected OSD menu items.
- Long press for 5 seconds to enable/disable the Key Lock function.

4. Shortcut(Left)

- Turns on the monitor when the monitor enters standby mode or displays the "NO SIGNAL" message.
 - Default: GamePlus hotkey
 - To change the hotkey function, go to the **MyFavorite > Shortcut > Shortcut(Left)** menu.
5. OSD dial
- Increases/Decreases values or moves your selection up/down.

1.3.2 Back view

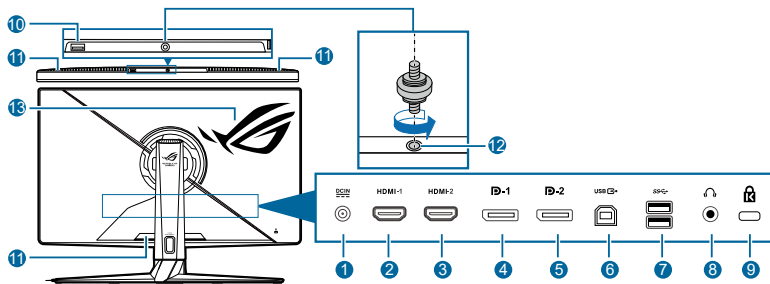

1. **DC-IN port.** This port connects the power cord.
2. **HDMI-1 port.** This port is for connection with an HDMI compatible device.
3. **HDMI-2 port.** This port is for connection with an HDMI compatible device.
4. **DisplayPort-1.** This port is for connection with a DisplayPort compatible device.
5. **DisplayPort-2.** This port is for connection with a DisplayPort compatible device.
6. **USB 3.2 Gen 1 Type-B.** This port is for connection with a USB upstream cable. The connection enables the USB ports on the monitor.
7. **USB 3.2 Gen 1 Type-A.** These ports are for connection with USB devices, such as USB keyboard/mouse, USB flash drive, etc.
8. **Earphone jack.**
9. **Kensington lock slot.**
10. **USB 2.0 Type-A.** This port is for connection with USB devices, such as USB keyboard/mouse, USB flash drive, etc.
11. **Vent (heated air exhaust).**





Do not cover the ventilation slots on the monitor. Heat build-up can reduce the service life of your monitor and also be dangerous.

- 12. Screw hole (for the tripod screw).
- 13. AURA RGB/AURA Sync (controlled by Armoury Crate software).

1.3.3 GamePlus function

The GamePlus function provides a toolkit and creates a better gaming environment for users when playing different types of games. The crosshair overlay with 6 different crosshair options lets you choose the one that best suits the game you're playing. There are also on screen timer and stopwatch you can position on the left of the display so you can keep track of the gaming time; while the FPS (frames per second) counter lets you know how smooth the game is running. The position of FPS Counter, Timer and Stopwatch can be moved by the OSD Dial. Sniper function (only available when the resolutions are above 1920 x 1080@120Hz and HDR is disabled on your device)) is customized for first-person shooters. You can select the magnification ratio and the type of alignment in sequence.

To activate GamePlus:

1. Press the GamePlus shortcut button
2. Turn the OSD dial left/right to select among different functions.
3. Press the OK button to activate the function you choose, or display the settings.
4. Turn the OSD dial left/right to navigate through the settings. Highlight the desired setting and press the OK button to activate it.
5. Press the  Back button to go back, or press the  Exit button to exit.

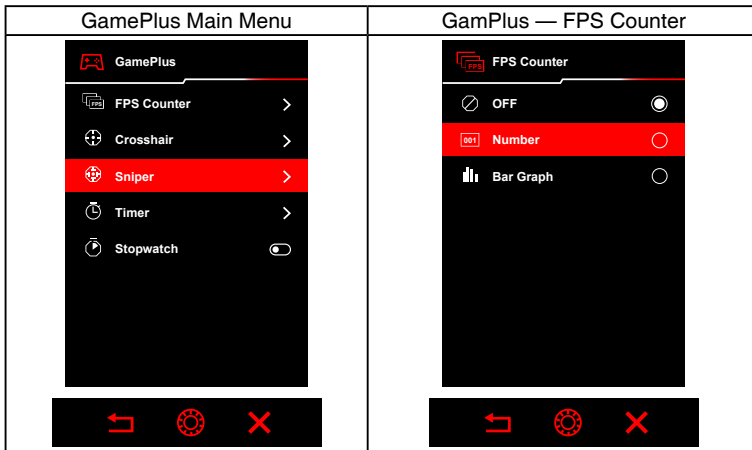

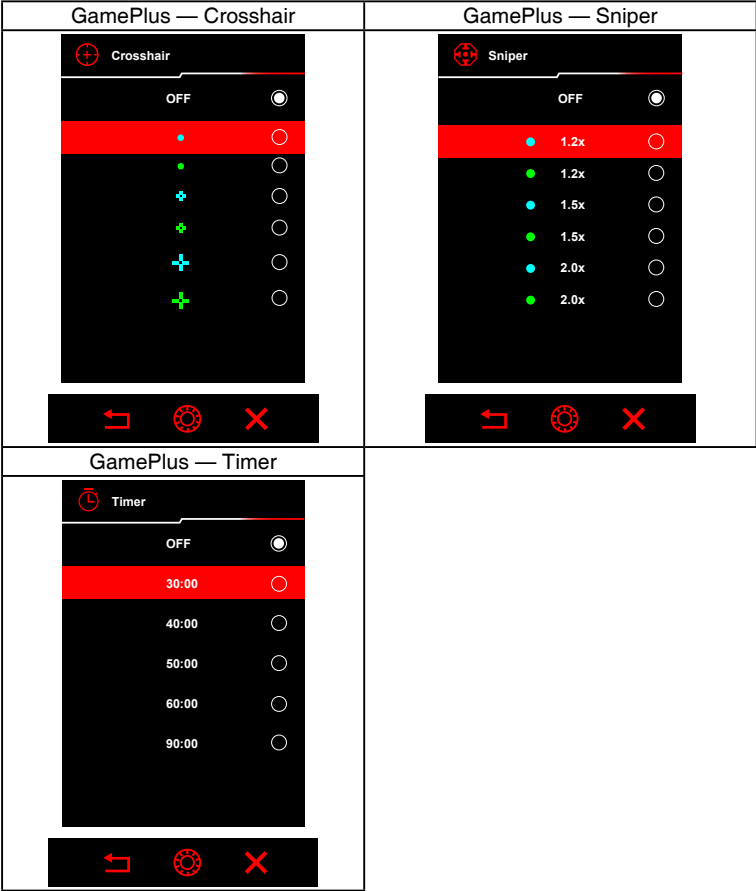



1.3.4 GameVisual function

The GameVisual function helps you select among different picture modes in a convenient way.

To activate GameVisual:

1. Press the GameVisual shortcut button
2. Turn the OSD dial left/right to highlight a desired setting.
3. Press the OK button to activate it
4. Press the  Back button to go back, or press the  Exit button to exit.
 - **Scenery Mode:** This is the best choice for scenery photo displaying with GameVisual™ Video intelligence Technology.
 - **Racing Mode:** This is the best choice for racing game playing with GameVisual™ Video intelligence Technology.
 - **Cinema Mode:** This is the best choice for movie watching with GameVisual™ Video intelligence Technology.
 - **RTS/RPG Mode:** This is the best choice for Real-Time Strategy (RTS)/ Role-Playing Game (RPG) playing with GameVisual™ Video intelligence Technology.
 - **FPS Mode:** This is the best choice for First Person Shooter game playing with GameVisual™ Video intelligence Technology.
 - **sRGB Mode:** This is the best choice for viewing photos and graphics from PCs.
 - **MOBA Mode:** This is the best choice for multiplayer online battle arena game playing with GameVisual™ Video intelligence Technology.
 - **User Mode:** More items are adjustable in the Color menu.



-
- In the Racing mode, the following function(s) are not user-configurable: ASCR, Saturation, VividPixel.
 - In the sRGB mode, the following function(s) are not user-configurable: Shadow Boost, Color Temp., Contrast, ASCR, Saturation, Six-axis Saturation, Gamma, Display Color Space.
 - In the Scenery mode, the following function(s) are not user-configurable: Shadow Boost, Six-axis Saturation, Gamma.
 - In the Cinema mode, the following function(s) are not user-configuration: Shadow Boost, Six-axis Saturation, Gamma.
 - In the MOBA mode, the following function(s) are not user-configuration: ASCR, Six-axis Saturation, Saturation, VividPixel, Shadow Boost.
 - In the RTS/RPG mode and FPS mode, the following function(s) are not user-configuration: Six-axis saturation
-

1.3.5 Other Function(s)

- HDR

The monitor supports HDR format. When detecting HDR content, an "HDR ON" message will pop up and display in the OSD menu.



-
- When displaying HDR content, the following function(s) are not available: ELMB, GameVisual, Shadow Boost, Contrast, ASCR, Dynamic Dimming, Blue Light Filter, Color Temp., Gamma, Saturation, PIP/PBP Setup.
 - When HDR is enabled, to adjust the brightness, go to **Image > HDR Setting > Brightness Adjustable**.
-

2.1 Attaching the arm/base

To assemble the monitor base:

1. Take out the monitor as illustrated (Figure 1).
2. Insert the base into the arm (Figure 2).
3. Fix the base to the arm by fastening the bundled screw. (Figure 2).
4. Hold the stand and lift the monitor carefully, then place it on a flat surface (Figure 3).

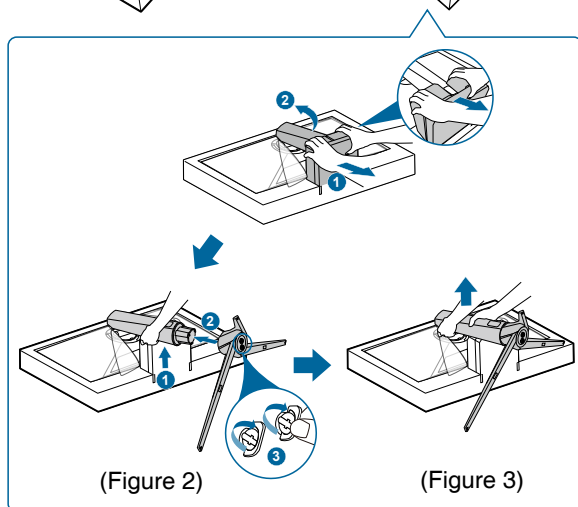
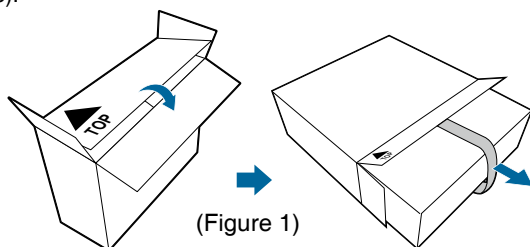

We recommend that you cover the table surface with soft cloth to prevent damage to the monitor.



Base screw size: M6 x 15 mm.

2.2 Cable management

You can organize the cables with the help of the input/output port cover.

- **Arranging the cables**

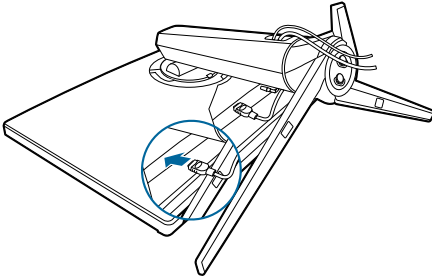

- **Using the input/output port cover:** the cover can be attached or detached.

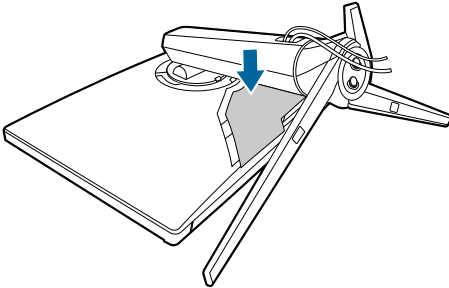

2.3 Detaching the arm/base (for VESA wall mount)

The detachable arm of this monitor is specially designed for VESA wall mount.

To detach the arm:

1. Have the front of the monitor face down on a table.
2. Use a screwdriver to remove the covers on where the monitor and the arm meet.
3. Loosen the four screws on the back of the monitor (screw size: M4 x 10 mm) and remove the arm/base.
4. Fasten the wall mount spacer screws.

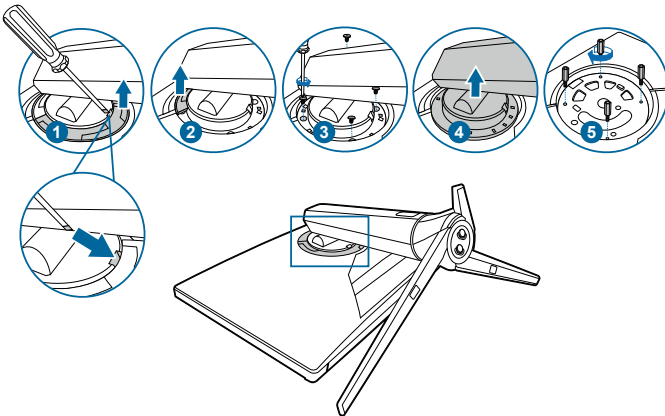

Handle with caution to avoid injury or damage to the monitor.



- The VESA wall mount kit (100 x 100 mm) is purchased separately.
- Use only the UL Listed Wall Mount Bracket with minimum weight/load 22.7kg (Screw size: M4 x 10 mm).

2.4 Adjusting the monitor

- For optimal viewing, we recommend that you look at the full face of the monitor, then adjust the monitor to the angle that is most comfortable for you.
- Hold the stand to prevent the monitor from falling when you change its angle.
- You can adjust the monitor's angle from $+20^{\circ}$ to -5° , and it allows 25° swivel adjustment from either left or right. You can also adjust the monitor's height within ± 70 mm.

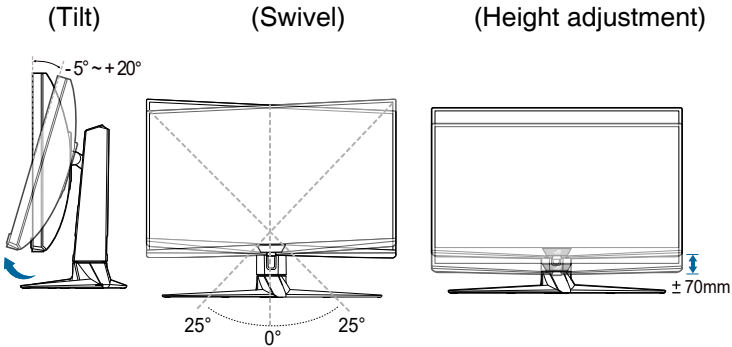

2.5 Connecting the cables

Connect the cables as the following instructions:

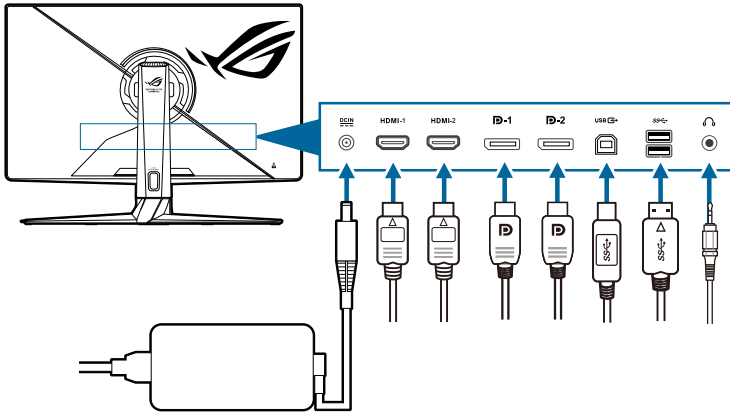

- **To connect the power cord:**
 - a. Connect the power adapter securely to the monitor's DC IN input.
 - b. Connect one end of the power cord to the power adapter and the other end to a power outlet.
- **To connect the HDMI/DisplayPort cable:**
 - a. Plug one end of the HDMI/DisplayPort cable to the monitor's HDMI/DisplayPort jack.
 - b. Connect the other end of the HDMI/DisplayPort cable to your device's HDMI/DisplayPort jack.
- **To use the earphone:** connect the audio cable to the monitor's earphone jack.
- **To use the USB 3.2 Gen 1 ports:** Take the supplied USB cable, and plug the smaller end (type B) of the USB upstream cable to the monitor's USB upstream port, and the larger end (type A) to your computer's USB port. Make sure your computer is installed with the latest Windows 10/Windows 11 operating system. That will enable the USB ports on the monitor to work.



When these cables are connected, you can choose the desired signal from the Input Select item in the OSD menu.



If you need to replace the power cord or the connection cable(s), please contact ASUS customer service.



The USB cable can be used for firmware update.

2.6 Turning on/off the monitor

- **To turn on the monitor:**

Press center of the dial button. See page 1-2 for the location of the buttons. The power indicator  lights up in white to show that the monitor is ON.



- **To turn off the monitor:**

Turn the OSD dial right to highlight  and press the OK button.

3.1 OSD (On-Screen Display) menu

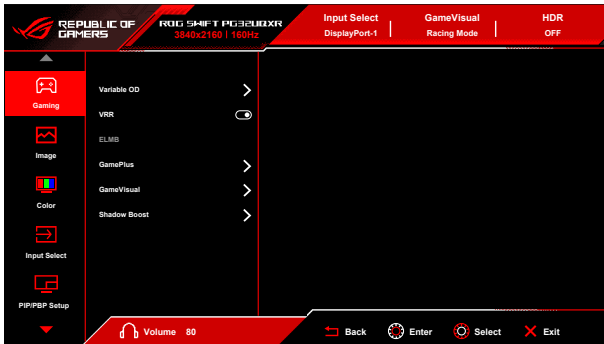
3.1.1 How to reconfigure



1. After the monitor is turned on, turn the OSD dial left/right to select  Menu and press the OK button to activate the OSD menu.
2. Turn the OSD dial left/right to navigate through the functions. Highlight the desired function and press the OK button to activate it. If the function selected has a sub-menu, turn the OSD dial left/right to navigate through the sub-menu functions. Highlight the desired sub-menu function and press the OK button to activate it.
3. Turn the OSD dial left/right to change the settings of the selected function.
4. To exit and save the OSD menu, press the  Back button repeatedly or press the  Exit button until the OSD menu disappears. To adjust other functions, repeat steps 1-3.

3.1.2 OSD function introduction

1. Gaming

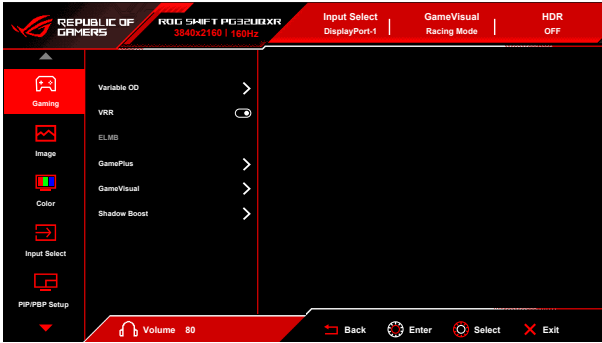

- **Variable OD:** Improves the gray level response time of the LCD panel.



This function is not available when **ELMB** is enabled.

- **VRR:** Allows an **VRR** supported* graphics source to dynamically adjust display refresh rate based on typical content frame rates for power efficient, virtually stutter free and low-latency display update.



To activate **VRR**, turn off **ELMB** function first.

***VRR** can only be activated within 48Hz~160Hz for HDMI, and 48Hz~160Hz for DisplayPort.

*For supported GPUs, minimum PC system and driver requirements, please contact the GPU manufactures.

- **ELMB:** **ELMB** can only be activated when **VRR** is Off.
- **GamePlus:** See **1.3.3 GamePlus Function** for details.
- **GameVisual:** See **1.3.4 GameVisual Function** for details.
- **Shadow Boost:** Dark color enhancement adjusts monitor gamma curve to enrich the dark tones in an image, making dark scenes and objects much easier to be seen.



This function is only available in **Racing Mode, RTS/RPG Mode, FPS Mode, sRGB Mode, or User Mode.**

2. Image

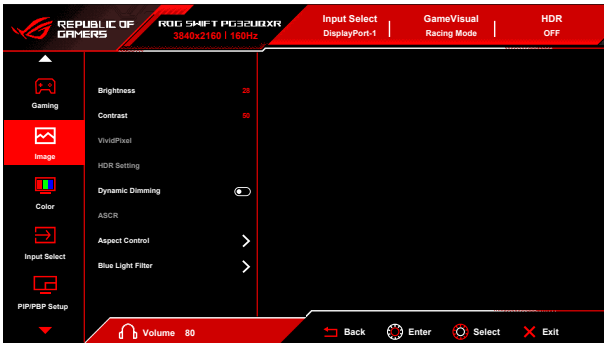

- **Brightness:** The adjusting range is from 0 to 100.
- **Contrast:** The adjusting range is from 0 to 100.
- **VividPixel:** This function enhances the outline of the displayed picture and generates high-quality images on screen.
- **HDR Setting:** Set the HDR mode to **ASUS Gaming HDR**, **ASUS Cinema HDR**, or **Console HDR**. The HDR brightness can be adjusted when the **Brightness Adjustable** function is enabled.
- **Dynamic Dimming:** Synchronizes with contents while contrast changing to execute backlight dynamic dimming.
- **ASCR:** Turns on/off the ASCR (ASUS Smart Contrast Ratio) function.



ASCR, ELMB, Low Blue Light Filter and PIP/BBP mode are not available (set as OFF) when **Dynamic Dimming** is enabled.



HDR PQ curve will be affected when the **Brightness Adjustable** is ON under HDR mode.

- **Aspect Control:** Adjust the aspect ratio to **16:9**, **4:3** or **21:9** to enjoy different gaming scenario.
 - **16:9:** Simply choose **Simulate 27"** or **Simulate 25"** under **Full** for better FPS gaming size; or you can choose **Pixel by pixel** such as 3232 x 1822 resolution for 27" or 2992 x 1682 resolution for 25" under Windows Display setting.
 - **4:3:** Provides multiple 4:3 aspect ratio choices with different screen sizes, including **Full**, **Equivalent** and **Pixel by pixel**.
 - **21:9:** It can be used to simulate 21:9 screen. 3840 x 2160 or 3440 x 1440 resolution can be choose under Windows Display setting. Different screen sizes, including **Full**, **Equivalent** and **Pixel by pixel** are also provided.

- **Blue Light Filter:**

- **Level 0:** No change.
- **Level 1~4:** The higher the level, the less blue light is scattered. When Blue Light Filter is activated, the default settings of Racing Mode will be automatically imported. Between Level 1 to Level 3, the Brightness function is user-configurable. Level 4 is an optimized setting. It is in compliance with TUV Low Blue Light Certification. The Brightness function is not user-configurable.



Please refer to the following to alleviate eye strains:

- Users should take some time away from the display if working for long hours. It is advised to take short breaks (at least 5 mins) after around 1 hour of continuous working at the computer. Taking short and frequent breaks is more effective than a single longer break.
 - To minimize eye strain and dryness in your eyes, you should rest the eye periodically by focusing on objects that are far away.
 - Eye exercises can help to reduce eye strain. Repeat these exercises often. If eye strain continues please consult a physician. Eye exercises: (1) Repeating look up and down (2) Slowly roll your eyes (3) Move your eyes diagonal.
 - High energy blue light may lead to eye strain and AMD (Age-Related Macular Degeneration). Blue light Filter reduces 70% (max.) harmful blue light to avoid CVS (Computer Vision Syndrome).
-

3. Color

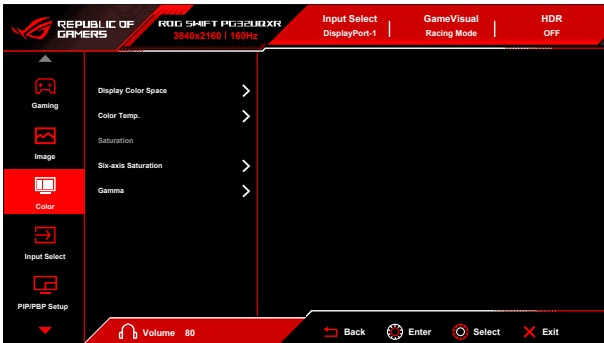

- **Display Color Space:** “sRGB” is recommended when using Microsoft based systems. “Wide Gamut” is recommended when using Mac OS systems.
- **Color Temp.:** Contains 8 modes including **4000K, 5000K, 6500K, 7500K, 8200K, 9300K, 10000K** and **User Mode**.
- **Saturation:** The adjusting range is from 0 to 100.



This function is not available when **Racing Mode, sRGB Mode** or **MOBA Mode** is selected.

- **Six-axis Saturation:** Adjusts the saturation for R, G, B, C, M, Y.
- **Gamma:** Allows you to set the color mode to **2.6, 2.4, 2.2, 2.0** or **1.8**.

4. Input Select

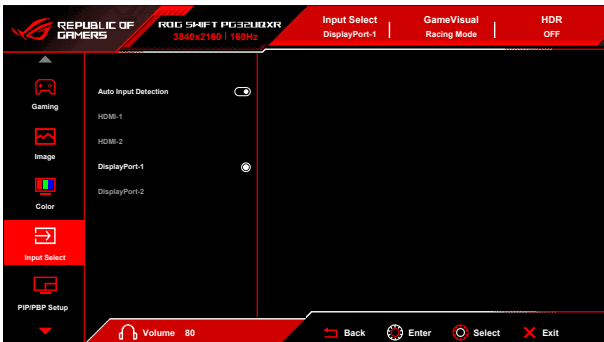

- **Auto Input Detection:** When enabled, the system will automatically select the latest inserted I/O port.
- **HDMI-1, HDMI-2, DisplayPort-1, DisplayPort-2:** Manually selects the input source.

5. PIP/PBP Setup

The **PIP/PBP Setup** allows you to open up sub-window(s) connected from any video source.



To activate this function, you need to do the following: turn off **Dynamic Dimming**, turn off **VRR** and disable **HDR** on your device.

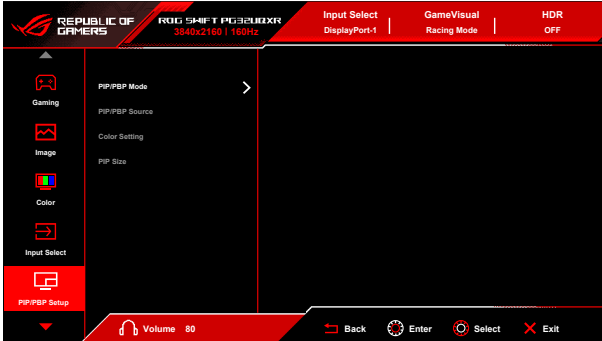

- **PIP/PBP Mode:** Selects PIP, PBP mode or turn it off.
- **PIP/PBP Source:** Selects the video input source from among **HDMI-1**, **HDMI-2**, **DisplayPort-1**, and **DisplayPort-2**.
- **Color Setting:** Sets GameVisual mode for each PIP/PBP window.
- **PIP Size:** Adjusts the PIP size to **Small**, **Middle**, or **Large**.

6. Lighting Effect

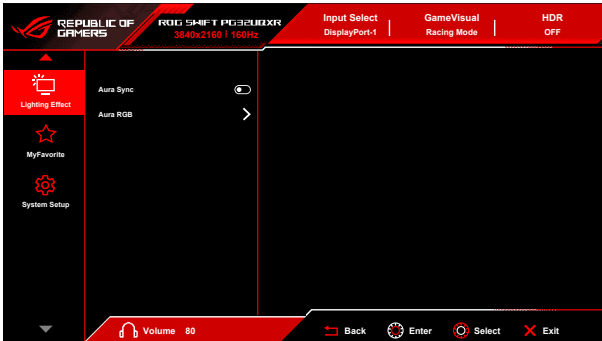

- **Aura Sync:** Allows you to turn on or off the Aura Sync function that synchronizes the Aura RGB light effect among all supported devices.
- **Aura RGB:** There are 5 living colors can be chosen: **Color Cycle**, **Static**, **Breathing**, **Strobing**, **OFF**. You can manually change the **R/G/B/C/M/Y** color for **Static**, **Breathing**, and **Strobing** modes.



This function is not available when **Aura Sync** is enabled.

7. MyFavorite

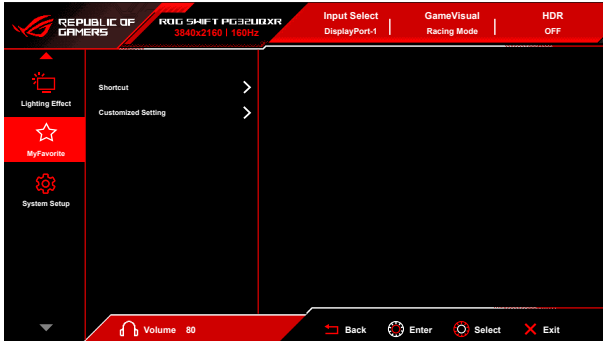

- **Shortcut:**
 - **Shortcut(Right)/Shortcut(Left):** Sets the shortcut functions for shortcut buttons.



When a certain function is selected or activated, your shortcut button may not support. Available function choices: GamePlus, GameVisual, Brightness, Mute, Shadow Boost, Contrast, Input Select, HDR setting, PIP/PBP Setup, Blue Light Filter, Variable OD, Customized Setting-1 (Load), Customized Setting-2 (Load)

- **Customized Setting:** Loads/Saves all settings on the monitor.

8. System Setup

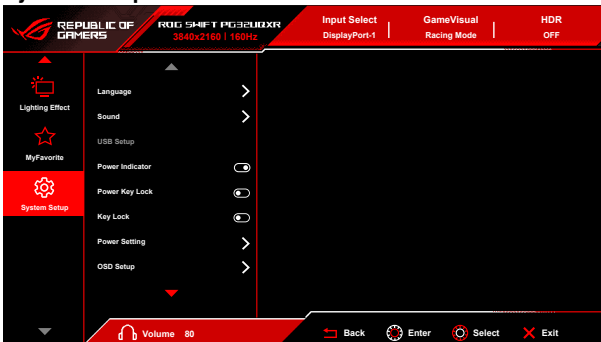

- **Language:** There are 22 languages for your selection, including English, French, German, Italian, Spanish, Dutch, Portuguese, Russian, Czech, Croatian, Polish, Romanian, Hungarian, Turkish, Simplified Chinese, Traditional Chinese, Japanese, Korean, Thai, Indonesian, Persian, Ukrainian.

- **Sound:** Sets the sound related settings from this menu.
 - **Volume (Earphone Out):** The adjusting range is from 0 to 100.
 - **Mute:** Toggles the monitor sound between on and off.
 - **Source:** Decides the monitor sound comes from which source.
- **USB Setup:** Turns On/Off the **USB Setup** function during standby mode.



This function is not available (set as **On During Standby**) when **Aura Sync** is enabled.

- **Power Indicator:** Turns the power LED indicator on/off.
- **Power Key Lock:** Enables or disables the power key.
- **Key Lock:** To disable all function keys. Press OK button for over 5 seconds to cancel the key lock function.
- **Power Setting:**
 - **Standard Mode:** Standard mode setting may result in higher power consumption.
 - **Power Saving Mode:** Power saving mode may cause limited luminance performance.



Certain functions that consumes power will be disabled when **Power Saving Mode** is selected. If you wish to enable the functions, choose **Standard Mode**.



Please turn off HDR function before activating the **Power Saving Mode**.

- **OSD Setup:**
 - Adjusts the OSD position horizontally.
 - Adjusts the OSD timeout from 10 to 120 seconds.
 - Adjusts the OSD background from opaque to transparent.
 - Enables or disables the DDC/CI function.
- **DisplayPort Stream:** Compatibility with graphic card. Select **DisplayPort 1.2**, **DisplayPort 1.4**, or **DisplayPort 2.1** by by graphic card supported DP version.
- **DSC Support:** DisplayPort Display Stream Compression.
- **HDMI CEC:** Allows power on/off control of the console device or setup box, such as Apple TV, Sony PlayStation, Xbox Series X/S, Nintendo Switch through the monitor. The default setting is **OFF**.



If the monitor is turned on, the CEC source device will automatically power on, and vice versa. If the CEC source device is turned on, the monitor will automatically power on.

- **Information:** Shows the monitor information.
- **All Reset:** Selecting “**Yes**” allows you to restore the default settings.

3.2 Aura

Armoury Crate is a software program that controls the colorful LEDs on supported devices, such as monitors, motherboards, graphic cards, desktop PCs, etc. Aura allows you to adjust the color of the RGB LEDs on these devices and select different light effects. You can also correct or adjust the color of the LEDs by calibrating them.

To activate Aura:

1. Turn ON the **Aura Sync** function in the OSD menu.
2. Connect the USB 3.2 Gen 1 upstream port of the monitor to the USB port of your computer.
3. Install Armoury Crate and then restart the computer.
4. Execute Armoury Crate.

Below is the overview of this program.

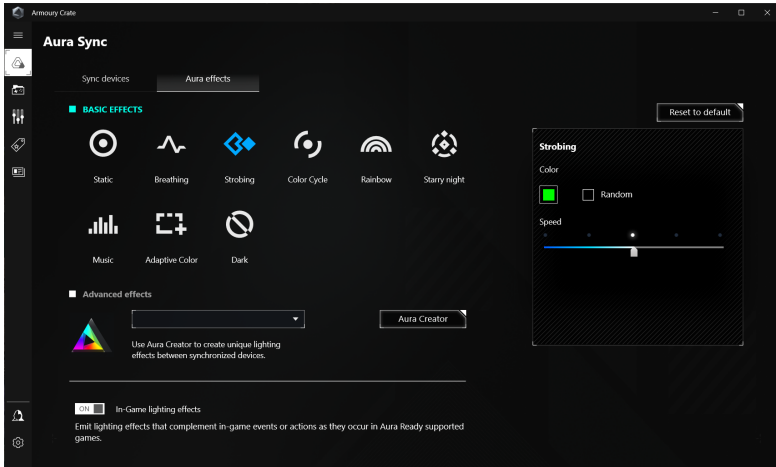

- If the USB upstream connection between the monitor and computer is disconnected, to resume the Aura function, you need to re-connect the USB 3.2 Gen 1 upstream port of the monitor to the computer and then restart the computer.
- Visit https://rog.asus.com/innovation/armoury_crate/ for more details.

3.3 Specifications summary

Panel Type	Fast IPS, Mini LED (576 zones)
Panel size	32.0" (16:9, 81.3 cm) wide screen
Max. Resolution	3840 x 2160
Pixel pitch	0.1845 mm x 0.1845 mm
Brightness	400 cd/m ² (SDR), 1000 cd/m ² (HDR)
Contrast Ratio (Typ.)	1,000:1
Viewing angle (H/V) CR>10	178°/178°
Display colors	1073.7 M (10 bit)
Color gamut	DCI-P3 96%
Response time	1 ms (GTG)
Color temperature selection	8 color temperatures
Digital input	HDMI v2.1 x 2, DisplayPort v2.1 x 2
Earphone jack	Yes
Audio input	No
Speaker (Built-in)	No
USB 3.2 Gen 1 port	1 x USB 3.2 Gen 1 Type-B 2 x USB 3.2 Gen 1 Type-A
USB 2.0 port	1 x USB 2.0 Type A
Color	Black
Power LED	White (On)/Amber (Standby)
Tilt	+20° ~ -5°
Swivel	+25° ~ -25°
Pivot	No
Height Adjustment	70 mm
Kensington lock	Yes
Voltage rating	AC: 100~240V DC: 20.0V --- 12.0A (AC adapter)
Power consumption	Power On: < 51 W** (Typ.), Standby: < 0.5 W, Power Off: < 0.3 W
Temperature (Operating)	0°C~40°C
Temperature (Non-operating)	-20°C~+60°C
Dimension (W x H x D) without stand	726 x 441 x 95 mm
Dimension (W x H x D)	726 x 541 x 279 mm (with stand, highest) 726 x 471 x 279 mm (with stand, lowest) 829 x 640 x 282 mm (package)
Weight (Esti.)	7.2 kg (without stand); 10.8 kg (Net); 15.9 kg (Gross)
Multi-languages	22 languages (English, French, German, Italian, Spanish, Dutch, Portuguese, Russian, Czech, Croatian, Polish, Romanian, Hungarian, Turkish, Simplified Chinese, Traditional Chinese, Japanese, Korean, Thai, Indonesian, Persian, Ukrainian)

Accessories	Quick start guide, warranty card, power adapter, power cord, HDMI cable, DisplayPort cable, USB cable, ROG welcome card with envelope, color calibration testing report, input/output port cover, wall mount screws, tripod screw, ROG sticker, ROG pouch, assembly tips
Compliance and Standards	cTUVus, FCC, ICES-3, CB, CE, ErP, WEEE, EU Energy label , UkrSEPRO, Ukraine Energy, CU, CCC, China Energy Label, BSMI , RCM, MEPS, VCCI, PSE, PC Recycle , J-MOSS, KC, KCC, e-Standby, PSB, RoHs, CEC, Windows 10 & 11 WHQL, TUV Flicker free, TUV Low Blue Light

*Specifications are subject to change without notice.

**measuring a screen brightness of 200 nits without audio/USB/Card reader connection.

3.4 Outline dimensions

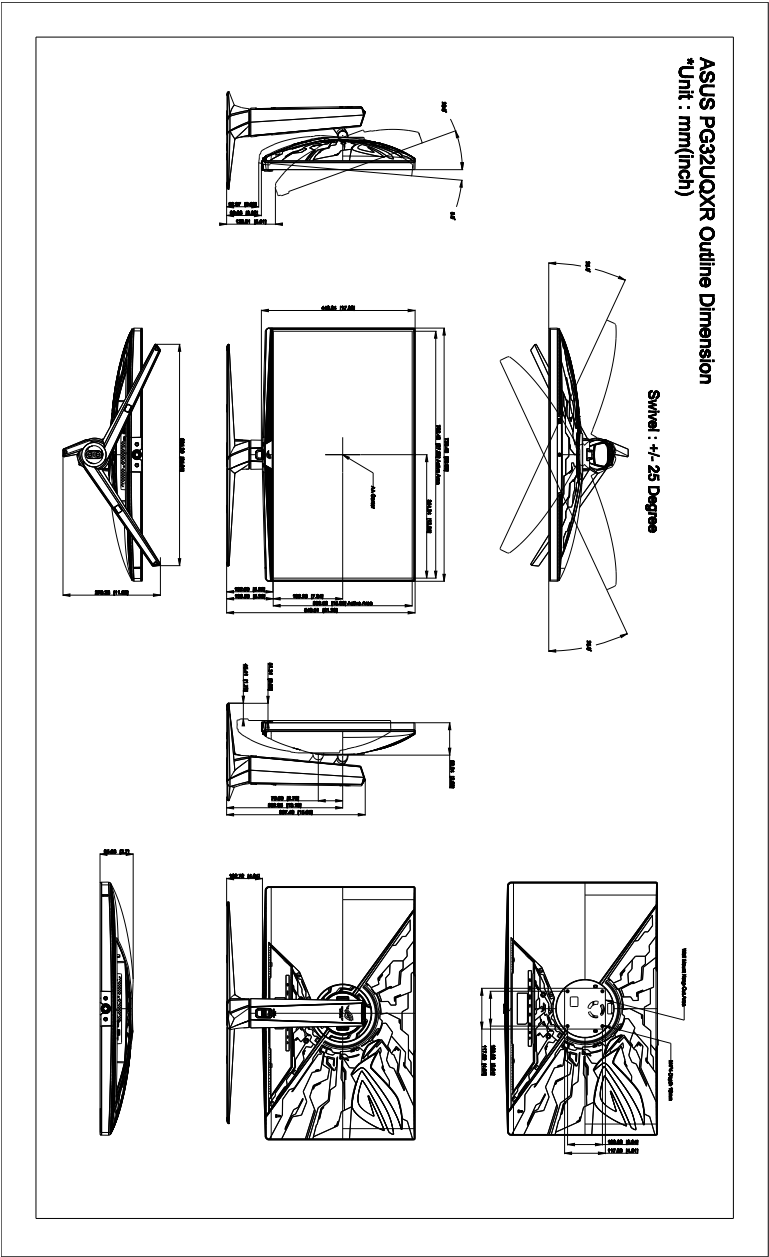

3.5 Troubleshooting (FAQ)

Problem	Possible Solution
Power LED is not ON	<ul style="list-style-type: none"> • Press any button to check if the monitor is in the ON mode. • Check if the power cord is properly connected to the monitor and the power outlet. • Check if the power switch is ON.
The power LED lights amber and there is no screen image	<ul style="list-style-type: none"> • Check if the monitor and the computer are in the ON mode. • Make sure the signal cable is properly connected the monitor and the computer. • Inspect the signal cable and make sure none of the pins are bent. • Connect the computer with another available monitor to check if the computer is properly working.
Screen image is too light or dark	<ul style="list-style-type: none"> • Adjust the Contrast and Brightness settings via OSD.
Screen image bounces or a wave pattern is present in the image	<ul style="list-style-type: none"> • Make sure the signal cable is properly connected to the monitor and the computer. • Move electrical devices that may cause electrical interference.
Screen image has color defects (white does not look white)	<ul style="list-style-type: none"> • Inspect the signal cable and make sure that none of the pins are bent. • Perform All Reset via OSD. • Adjust the R/G/B color settings or select the Color Temperature via OSD.
No sound or sound is low	<ul style="list-style-type: none"> • Ensure that the HDMI/DisplayPort cable is properly connected to the monitor and the computer. • Adjust the volume settings of both your monitor and HDMI/DisplayPort device. • Ensure that the computer sound card driver is properly installed and activated.
HDR content is not played properly	<ul style="list-style-type: none"> • Make sure the input source supports HDR playback (with proper system settings and latest software). • Make sure the content is HDR encoded.

3.6 Supported operating modes

- **Native timings**

Resolution frequency	Refresh rate
640 x 480	60/67/72/75Hz
720 x 400	70Hz
720 x 480	60Hz
720 x 576	50Hz
800 x 600	56/60/72/75Hz
832 x 624	75Hz
1024 x 768	60/70/75Hz
1152 x 864	75Hz
1280 x 720	50/60Hz
1280 x 960	60Hz
1280 x 1024	60/75Hz
1440 x 900	60Hz
1680 x 1050	60Hz
1920 x 1080	24/25/30/50/60/100/120Hz
2560 x 1440	60/120/160Hz
3840 x 2160	24/25/30/50/60/100/120/144/160Hz

- **For 4:3 aspect control timings**

Resolution frequency	Refresh rate
640 x 480	60/67/72/75Hz
720 x 400	70Hz
720 x 480	60Hz
720 x 576	50Hz
800 x 600	56/60/72/75Hz
832 x 624	75Hz
1024 x 768	60/70/75/160Hz
1152 x 864	75/160Hz
1280 x 720	50/60Hz
1280 x 960	60/160Hz

Resolution frequency	Refresh rate
1280 x 1024	60/75/160Hz
1440 x 900	60Hz
1680 x 1050	60Hz
1920 x 1080	24/25/30/50/60/100/120Hz
2560 x 1440	60Hz (DisplayPort only)
2560 x 1440	120Hz
3840 x 2160	24/25/30/50/60/100/120Hz

- **For 21:9 aspect control timings**

Resolution frequency	Refresh rate
640 x 480	60/67/72/75Hz
720 x 400	70Hz
720 x 480	60Hz
720 x 576	50Hz
800 x 600	56/60/72/75Hz
832 x 624	75Hz
1024 x 768	60/70/75Hz
1152 x 864	75Hz
1280 x 720	50/60Hz
1280 x 960	60Hz
1280 x 1024	60/75Hz
1440 x 900	60Hz
1680 x 1050	60Hz
1920 x 1080	24/25/30/50/60/100/120Hz
2560 x 1440	60Hz (DisplayPort only)
2560 x 1440	120/160Hz
3840 x 2160	24/25/30/50/60/100/120Hz
2560 x 1080	160Hz
3440 x 1440	160Hz
3840 x 1600	160Hz

- **For 16:9 (Simulate 25") aspect control timings**

Resolution frequency	Refresh rate
640 x 480	60/67/72/75Hz
720 x 400	70Hz
720 x 480	60Hz
720 x 576	50Hz
800 x 600	56/60/72/75Hz
832 x 624	75Hz
1024 x 768	60/70/75Hz
1152 x 864	75Hz
1280 x 720	50/60Hz
1280 x 960	60Hz
1280 x 1024	60/75Hz
1440 x 900	60Hz
1680 x 1050	60Hz
1920 x 1080	24/25/30/50/60/100/120Hz
2560 x 1440	60Hz (DisplayPort only)
2560 x 1440	120/160Hz
3840 x 2160	24/25/30/50/60/100/120/160Hz
2992 x 1682	160Hz

- **For 16:9 (Simulate 27") aspect control timings**

Resolution frequency	Refresh rate
640 x 480	60/67/72/75Hz
720 x 400	70Hz
720 x 480	60Hz
720 x 576	50Hz
800 x 600	56/60/72/75Hz
832 x 624	75Hz
1024 x 768	60/70/75Hz
1152 x 864	75Hz
1280 x 720	50/60Hz
1280 x 960	60Hz
1280 x 1024	60/75Hz

Resolution frequency	Refresh rate
1440 x 900	60Hz
1680 x 1050	60Hz
1920 x 1080	24/25/30/50/60/100/120Hz
2560 x 1440	60Hz (DisplayPort only)
2560 x 1440	120/160Hz
3840 x 2160	24/25/30/50/60/100/120/160Hz
3232 x 1822	160Hz

- **For 16:9 (Pixel by pixel) aspect control timings**

Resolution frequency	Refresh rate
640 x 480	60/67/72/75Hz
720 x 400	70Hz
720 x 480	60Hz
720 x 576	50Hz
800 x 600	56/60/72/75Hz
832 x 624	75Hz
1024 x 768	60/70/75Hz
1152 x 864	75Hz
1280 x 720	50/60Hz
1280 x 960	60Hz
1280 x 1024	60/75Hz
1440 x 900	60Hz
1680 x 1050	60Hz
1920 x 1080	24/25/30/50/60/100/120Hz
2560 x 1440	60Hz (DisplayPort only)
2560 x 1440	120/160Hz
3840 x 2160	24/25/30/50/60/100/120/160Hz
2992 x 1682	160Hz
3232 x 1822	160Hz

ASUS

CE FC



<http://ROG.ASUS.com>