

## Highlights:

---

- 2" full range aluminum driver
- High-end ceiling speaker
- 10 Watt RMS power
- SlimLine™ grill with 1 mm thin border
- Elegant & unobtrusive design
- Warm & true to nature sound
- Paintable front grill
- Gold-Con™ spring clamps
- Thin edged white grill (RAL9003)

The CELO series is AUDAC's high-end, slim ceiling speaker series, comprising different models which can guarantee an optimal experience for every situation and application. The ultra-compact size enables the CELO2 to smoothly integrate into any interior like no other loudspeaker. The outer diameter only measures 118 mm, which is as compact as a standard down lighter and the built-in depth of 95 mm allows installation in any ceiling while being unobtrusive.

The sound originates from a 2" aluminum cone driver which provides a full-range, warm and detailed sound with an improved response in the low frequencies due to a ported enclosure with closed back can. This way, a smooth sound reproduction with clear and crisp sound is guaranteed. An internal self-resetting network provides an optimal overload protection. All these details share their part to the quality of the CELO2, resulting in a highly reliable loudspeaker producing a pure sound with a maximum power handling of 20 Watt and an RMS power handling of 10 Watt.

An elegant look with minimal visual impact is created by the slim grill with very thin border of only 1 mm. To make them blend in even more, the grill can be painted in the same color as the surrounding surface or an optional black grill (GLC02/B) will provide seamless integration in dark environments. The elegant and unobtrusive grill is held in place by means of powerful neodymium magnets, making assembly and disassembly very simple but still reliable enough to keep the grill in place during the complete lifetime of the loudspeaker.

Secure mounting and easy installation is guaranteed using the quick-fix mechanism which can be tightened by two screws and the Gold-Con™ spring clamp connectors. The grill is held in place using neodymium magnets, providing a quick and reliable assembly. stable assembly.

## Applications:

---

- Bars, restaurants
- Retail
- Public facilities
- Corporate spaces
- Residential

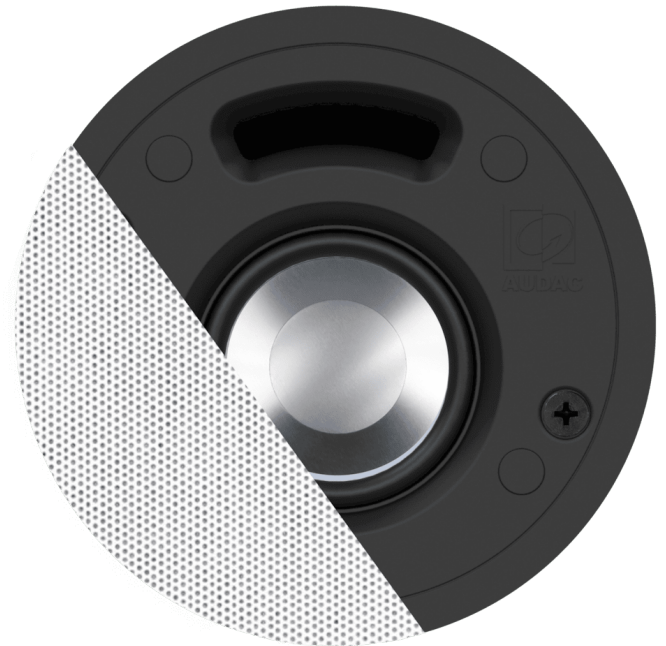

## Impedance:

---



## System specifications:

Speaker type		Full range
Program power handling		20 W
RMS/AES power handling		10 W
Impedance		8 $\Omega$ (CELO2) 16 $\Omega$ (CELO2D)
Sensitivity (1W/1m)		83 dB
Sound Pressure (Max. W/1m)		93 dB
Frequency	Response ( $\pm$ 3 dB)	120 Hz - 20 kHz
	Range (-10 dB)	100 Hz - 20 kHz
Dispersion	Conical	165°
Connectors		Gold-Con™ spring clamps
Drivers		2" Aluminium membrane

## Product Features:

Dimensions		118 x 98 mm ( $\emptyset$ x D)
Weight		0.350 kg
Construction		ABS
Front finish		Thin edged white grill (RAL9003)
Cut-out measurement		100 mm ( $\emptyset$ )
Built-in depth		95 mm
Mounting & handling		2 Screw quick-fixing mechanism
Operating temperature		-20 °C ~ 60 °C
Colours		Black frame & white grill
Accessories	Included	Cut-out template GLC02/W - White grill (RAL9003)
	Optional	WTR06 - 6W 100V line transformer GLC02/B - Black grill (RAL9005) GLC02/P - Paintable grill

## Variants:

- CELO2 - White version - 8 $\Omega$
- CELO2D - White version - 16 $\Omega$

## Shipping & Ordering:

Packaging	Cardboard box
Shipping weight & volume	0.500 kg - 0.002 Cbm

## Architects' and Engineers' Specifications:

---

The ceiling mount loudspeaker shall be a full range type fitted in a closed ported enclosure and equipped with a 2" aluminium cone driver with neodymium magnet. It shall have an RMS power handling of 10 Watt with a maximum power handling of 20 Watt and the frequency response ( $\pm 3$  dB) shall range from 120 Hz to 20 kHz. The sensitivity shall be 83 dB when measuring with an input signal of 1 Watt at a distance of 1 meter, while the maximum continuous sound pressure level shall be 93 dB. The nominal dispersion shall be a 165° conical coverage pattern at -6dB (average 100 Hz - 10 kHz). The loudspeaker shall have an impedance of 8 Ohm and shall contain an internal self-resetting network which provides an optimal overload protection. The speakers construction shall be made out of high-quality ABS with a black colour and textured matt surface finishing. A 2-screw quick-fixing mechanism shall allow assembly of the speaker into a ceiling in a fast and productive way while the connectivities are performed using Gold-Con™ spring clamp connectors. To make the loudspeaker nearly invisible when mounted, the speaker shall have a white (RAL9003) grill with a very thin border of 1 mm which extrudes the ceiling surface by only 3.2 mm. This grill shall be constructed of steel which can be painted to make it blend-in with any environment. The assembly and disassembly of the grill shall be very simple thanks to the neodymium magnets holding it in place. The speaker shall have a diameter of 118 mm, a depth of 98 mm and shall not exceed 0.35 kg. The speaker shall fit in a mounting hole with a cutout diameter of 100 mm and a build-in depth of 95 mm.

# Acoustical data graphs:

Polars:

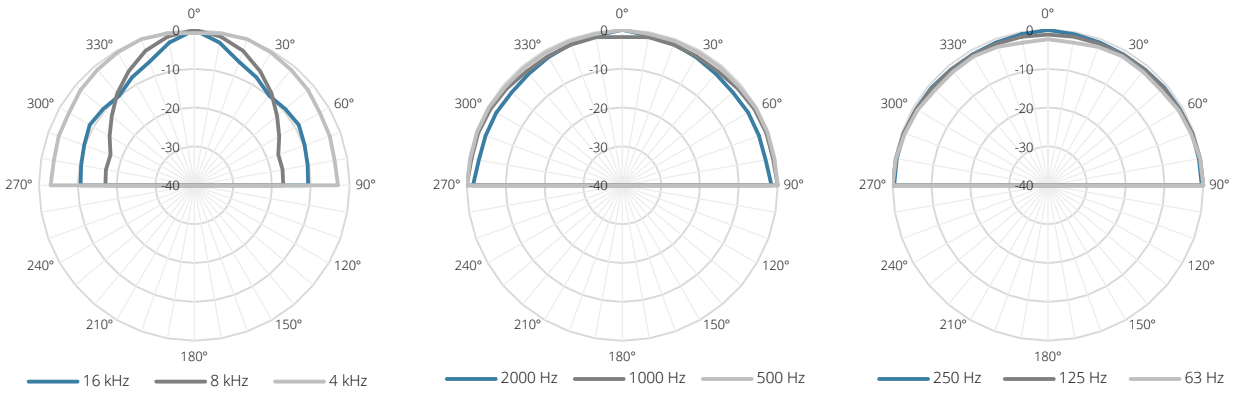

Sensitivity:

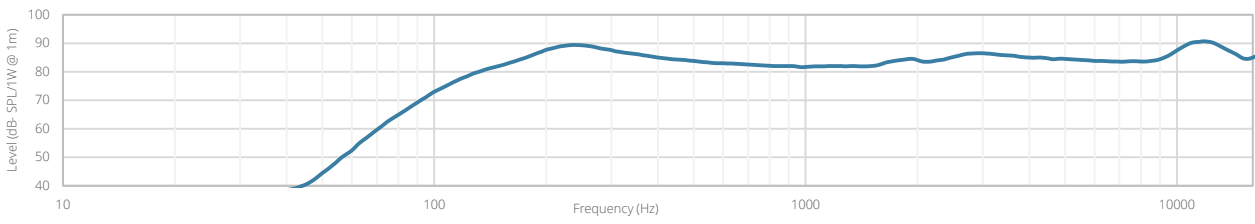

Beamwidth (-3dB):

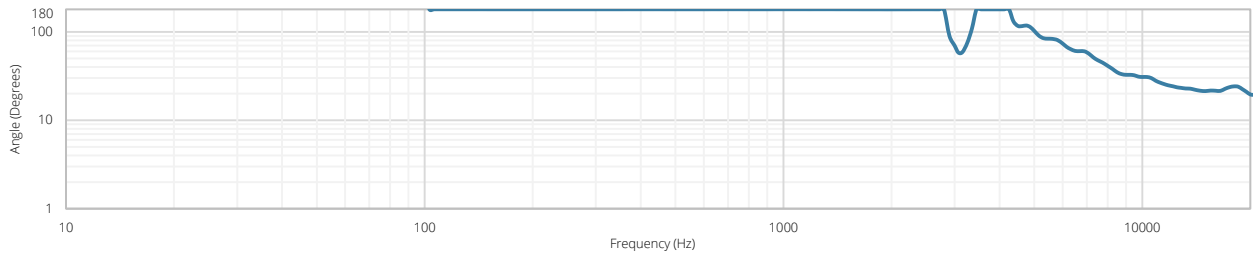

Directivity index:

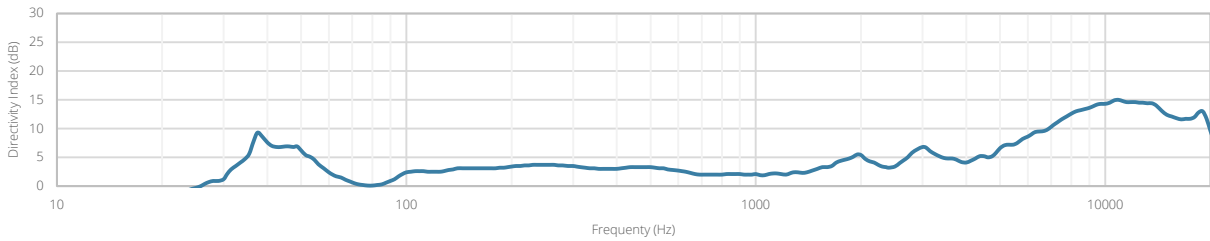

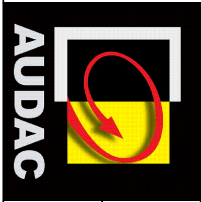
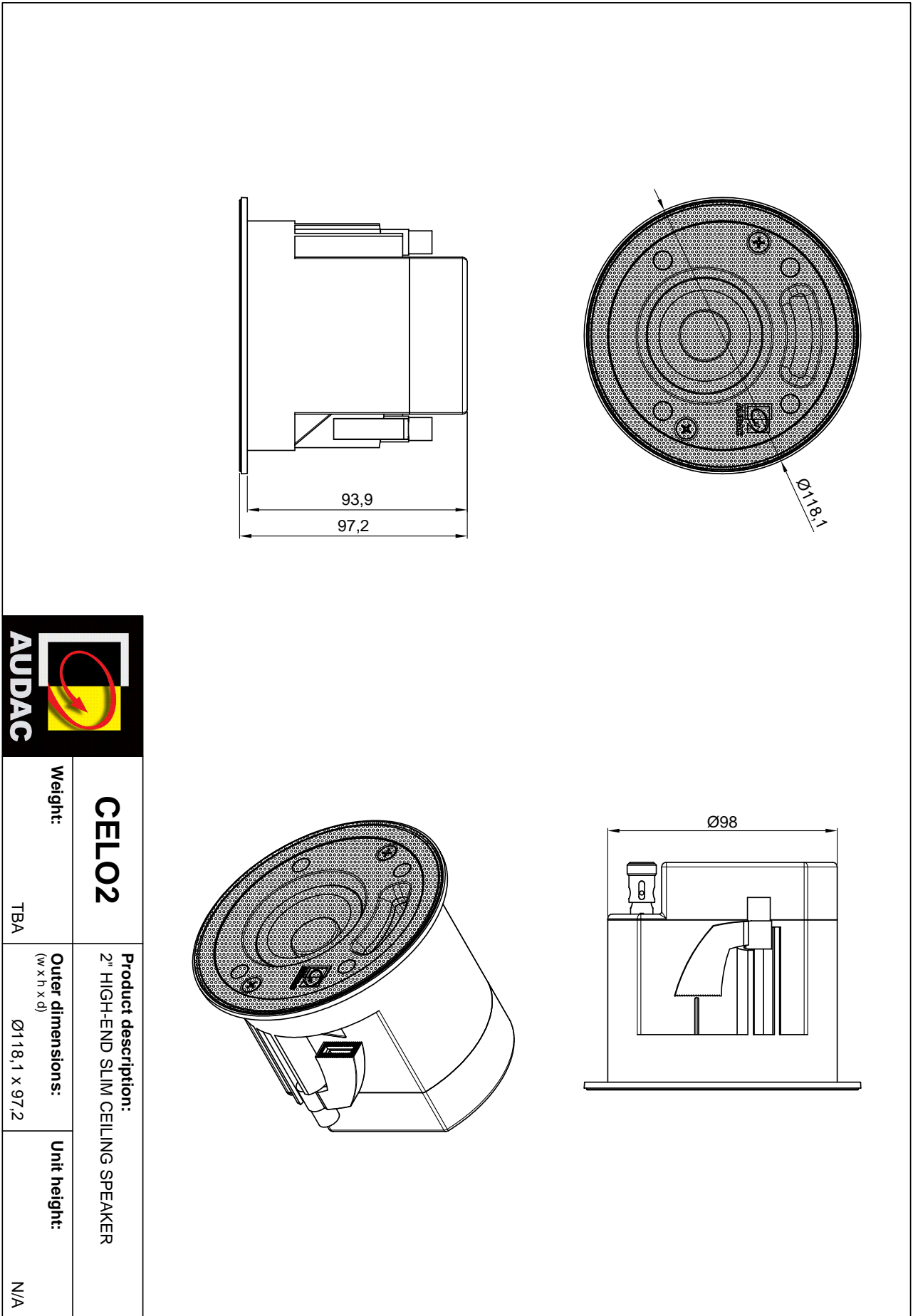

<p><b>CELO2</b></p>	<p><b>Product description:</b> 2" HIGH-END SLIM CEILING SPEAKER</p>	<p><b>Unit height:</b> N/A</p>
<p><b>Weight:</b> TBA</p>	<p><b>Outer dimensions:</b> (w x h x d) <math>\varnothing 118,1 \times 97,2</math></p>	<p><b>Unit height:</b> N/A</p>