

00054873
(DIR3020)

hama[®]

THE SMART SOLUTION

Digital Radio

Digital-Radio

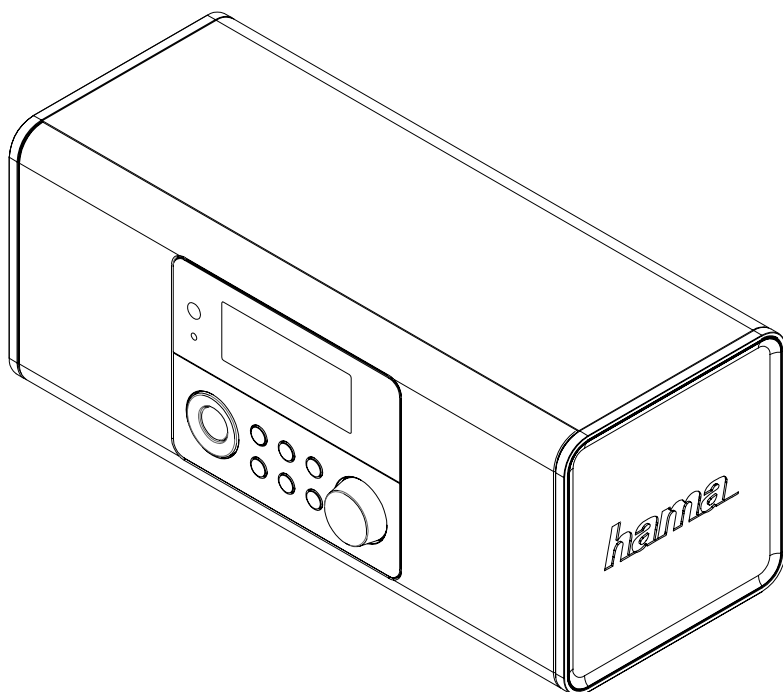

Operating Instructions / Bedienungsanleitung / Mode d'emploi / Instrucciones de uso /
Руководство по эксплуатации / Istruzioni per l'uso / Gebruiksaanwijzing / Οδηγίες χρήσης / Instrukcja obsługi /
Használati útmutató / Návod k použití / Návod na použitie / Manual de instruções / Kullanma kılavuzu /
Manual de utilizare / Bruksanvisning / Käyttöohje / Работна инструкция / Betjeningsvejledning / Manuelt stasjonssøk

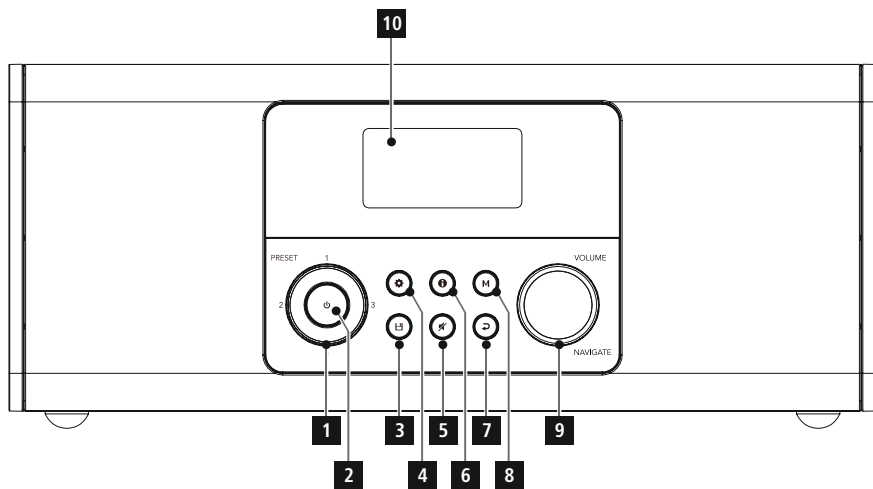
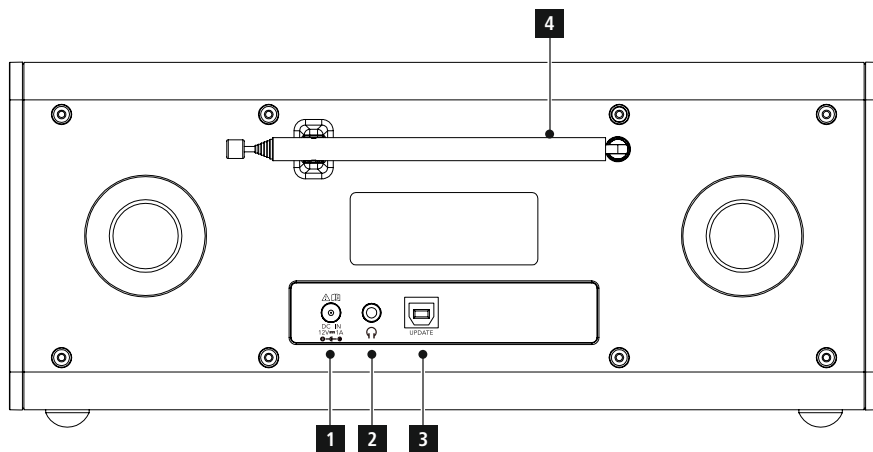





A**B**

Technical Data

Digital Radio	DAB ✓	DAB+ ✓	FM ✓	Internet ✓	Spotify -
Connectivity	WiFi 2.4GHz (b/g/n) / 5GHz (a/n)				
Display	2.5" Liquid Crystal Display (LCD)				
Encryption	WEP, WPA, WPA2, WPS				
Power input	12 V=1.0 A				
Power consumption	Operation	max. 12 W	Standby	< 1 W	
Frequency range	DAB/DAB+ 174 – 240 MHz		FM 87.5 – 108 MHz		
Input & Output	DC Socket, Headphone 3.5 mm, Update Port				
Presets	DAB / DAB+: 30	FM: 30		IR: 30	
UI Languages	Czech, English, Danish, Dutch, German, Finnish, French, Italian, Norwegian, Polish, Portuguese, Slovak, Spanish, Swedish, Turkish				
Package Content	"DIR3020" digital radio, mains power supply, operating instructions				
Dimensions (WxHxD)	30 x 11.5 x 12 cm				
Weight	1.6 kg				



Controls and Displays

A: Front		
1		Presets 1-4
2		[POWER] button
3		[MEMORY] button
4		[MENU/SETTINGS] button
5		[MUTE] button
6		[INFO] button
7		[BACK] button
8	M	[MODE] button
9		[NAVIGATE/ENTER/ VOLUME] button
10		Display

B: Reverse		
1	<i>DC IN</i>	Mains power supply
2		Headphone socket
3		Update port
4		Telescopic aerial

1. Explanation of Warning Symbols and Notes	5
2. Package Contents	5
3. Safety Notes	5
4. Informations and notes before getting started	6
5. Getting started	6
5.1 Radio – Connecting and starting up	6
5.2 General notes on use	6
6. Main menu / modes	7
7. Internet radio	7
7.1 Station search	7
7.1.1 Search by country or region	8
7.1.2 Search by genre	8
7.1.3 Search by name	8
7.1.4 Popular stations	8
7.1.5 New stations	8
7.1.6 Local stations	8
7.2 Podcasts	8
7.2.1 Search by country or region	9
7.2.2 Search by format (subjects or categories)	9
7.2.3 Search by name	9
7.3 Last listened	9
7.4 Favourites (local)	9
7.4.1 Assigning the Presets shortcut buttons	10
7.4.2 Calling up shortcut button presets	10
7.4.3 Assigning the list of presets (1-30)	10
7.4.4 Calling up a station from the Presets list (1-30)	10
7.5 Presets	10
7.5.1 First use – Registering your radio	10
7.5.2 Managing presets online	11
7.5.3 Opening the favourites list	11
7.5.4 My Added Stations	11
8. Music player	11
8.1 Playback from a computer (streaming)	11
8.2 Playback from the network – Accessing files using the radio	12
8.3 Playback of playlist	12
8.4 General playback options	12
9. Digital radio (DAB/DAB+)	13
9.1 Search / Automatic search	13
9.2 Station list	13
9.3 Edit station list	13
9.4 Presets	13
9.4.1 Assigning the Presets shortcut buttons	13
9.4.2 Calling up shortcut button presets	14
9.4.3 Assigning the list of presets (1-30)	14
9.4.4 Calling up a station from the Presets list (1-30)	14
9.5 DRC (Dynamic Range Control)	14
9.6 Station sequence	14
10. FM	14
10.1 Scan setting	14
10.2 Search / Automatic search	15
10.3 Presets	15
10.3.1 Assigning the Presets shortcut buttons	15
10.3.2 Calling up shortcut button presets	15
10.3.3 Assigning the list of presets (1-30)	15
10.3.4 Calling up a station from the Presets list (1-30)	15
10.4 Audio setting	15
11. Sleep	15
12. Alarms	16
12.1 Alarm settings	16
12.2 Activating / deactivating the alarm	16
12.3 Stopping the alarm/ Snooze function	16
13. System settings	16
13.1 Network	16
13.1.1 Network wizard – Configuration of Internet connection / Search	16
13.1.2 Wireless network connection (WLAN)	17
13.1.3 Manual configuration of network connection – wireless (WLAN)	17
13.1.4 View settings	18
13.1.5 Network profile	18
13.2 Time/ Date settings	19
13.3 Language	19
13.4 Factory Reset	19
13.5 Software update	20
13.6 Info	20
13.7 Lighting	20
14. Care and Maintenance	21
15. Warranty Disclaimer	21
16. Recycling Information	21
17. Declaration of Conformity	21

Menu structure

Main menu*

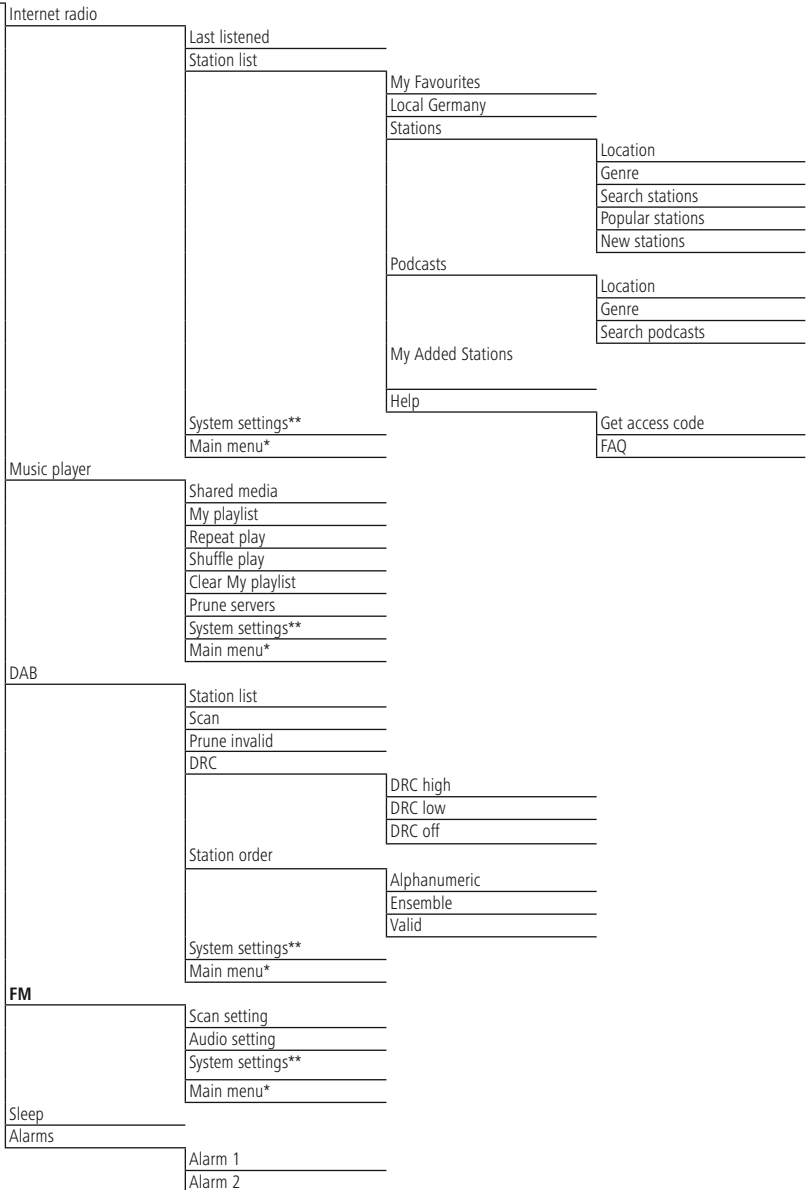

System settings**

Network	Network wizard
	PBC Wlan setup
	View settings
	Manual settings
	Network profile
Time/Date	Set Time/Date
	Auto update
	Update from DAB
	Update from FM
	Update from Network
	No Update
	Set format
	Set timezone
	Daylight savings
Language	
Factory reset	
Software update	Auto-check setting
	Checknow
Setup wizard	
Info	
Backlight	Power-on Level
	High
	Medium
	Low
	Standby Level
	Timeout
	Standby Level



Thank you for choosing a Hama product. Take your time and read the following instructions and information completely. Please keep these instructions in a safe place for future reference. If you sell the device, please pass these operating instructions on to the new owner.

1. Explanation of Warning Symbols and Notes

Warning



This symbol is used to indicate safety instructions or to draw your attention to specific hazards and risks.

Note



This symbol is used to indicate additional information or important notes.

Risk of electric shock



This symbol indicates product parts energized with a dangerous voltage of sufficient magnitude to constitute a risk of electric shock.

2. Package Contents

- DIR3020 digital radio
- AC/DC adapter
- Quick guide

3. Safety Notes

- The product is intended for private, non-commercial use only.
- Do not use the product in the immediate vicinity of heating, other sources of heat or in direct sunlight.
- Protect the product from dirt, moisture and overheating and use it in dry rooms only.
- As with all electrical devices, this device should be kept out of the reach of children.
- Children must not play with the device. Cleaning and user maintenance must not be carried out by children without supervision.
- Do not use the product in areas in which electronic products are not permitted.
- Be considerate. High volumes can disturb or interfere with your surroundings.
- Do not drop the product and do not expose it to any major shocks.
- Do not operate the product outside the power limits given in the technical data.
- Keep the packaging material out of the reach of children due to the risk of suffocation.
- Dispose of packaging material immediately according to locally applicable regulations.
- Do not modify the device in any way. Doing so voids the warranty.

Risk of electric shock



- Do not open the device or continue to operate it if it becomes damaged.
- Do not use the product if the AC adapter, adapter cable or power cable is damaged.
- Do not attempt to service or repair the product yourself. Leave any and all service work to qualified experts.



4. Informations and notes before getting started

Note



- For best reception, ensure that the antenna is fully extended and vertical.
- Try various different positions if necessary to get the best reception.

Network connection/ Preparing the internet connection

You can integrate this radio into a local network and even access home servers or other authorised resources. To receive Internet radio, an Internet connection is also required on the network.

WLAN connection (wireless network)

- Ensure that the router is switched on, is functioning correctly and that there is a connection to the Internet / network.
- Activate the WLAN function of your router if it is not already activated.
- Follow your router's operating instructions as regards the correct functioning of the WLAN connection.

Note



Use only original accessories (or: accessories approved by Hama) to avoid damage to the product.

5. Getting started

5.1 Radio – Connecting and starting up

Connect the power supply to the mains connection (1) on the back of the radio.

Connect the network cable to a properly installed and easily accessible network socket. The power supply unit is suitable for mains voltages between 100 and 240 V, and is thus operable on almost any AC power grid. Please note that a country-specific adapter may be necessary. You can find an appropriate selection of Hama products at www.hama.com.

Note



- Only connect the product to a socket that has been approved for the device.
- When using a multi-socket power strip, make sure that the sum power draw of all the connected devices does not exceed its maximum throughput rating.

- The electrical socket must always be easily accessible.
- If you will not be using the product for a long period of time, disconnect it from mains power.

Once the product has been connected to mains power, initialisation takes place. The radio starts up.

5.2 General notes on use

Note



- When a selection among menu items is to be made (such as **YES** or **NO**), the one currently selected has a light-coloured background fill.
- In menus offering a variety of different options (such as Language, Update, and so on), the currently selected option is marked with an asterisk (*).

Navigation and controls

- Select among menu items by turning [**NAVIGATE/ENTER/VOLUME**].
- Confirm the selection by pressing [**NAVIGATE/ENTER/VOLUME**].
- After pressing a shortcut button, navigate amongst the menu items using [**NAVIGATE/ENTER/VOLUME**].

Volume adjustment / mute

- You can turn the volume up (right) or down (left) by turning [**NAVIGATE/ENTER/VOLUME**] (9) accordingly.
- Press [M] (5) to mute the radio.
- Press [M] (5) again to reset the volume to the value it was prior to the radio being muted.

Entering passwords, search terms, and so on.

- Select each successive letter and digit by turning [**NAVIGATE/ENTER/VOLUME**] and confirm each selection by pressing [**NAVIGATE/ENTER/VOLUME**].
- To make corrections, select [**BKSP / <-**] and confirm. The last input made is deleted.
- To cancel input, select [**CANCEL**] and confirm.
- Once your input is complete, select [**OK**] and confirm to finish.



Additional information

Depending on the operating mode and stations available, pressing **[i]** (6) displays additional information:

- **Description**

Indicates the radio station, the current program, contents, subjects, etc.

- **Genre**

The genre (music style) of the station is shown.

- **Reliability / signal strength**

- **Bit rate**

The currently received digital bit rate of the received station is displayed.

- **Channel information**

- **Current time**

- **Today's date**

Switch On/Off / Standby

- Press **[P]** (2), to switch the device on or off (Standby).
- To completely switch off the device, disconnect it from the power supply.

6. Main menu / modes

This device supports radio reception via the Internet, DAB/DAB+ and FM.

The main menu contains the various operating modes as well as other options that are explained separately in the following chapters:

- 7. **Internet radio**

- 8. **Music player**

- 9. **DAB**

- 10. **FM**

- 11. **Sleep**

- 12. **Alarms**

- 13. **System settings**

Select amongst the available operating modes by repeatedly pressing **[M]** (8).

During playback, the current operating mode appears at the top left-hand edge of the screen.

7. Internet radio

The radio uses the station list on the vTuner* portal. You can use stations without direct registration on the following portal: <http://www.wifiradio-fronter.com>. You will find detailed operating instructions under **7.5 Presets**.

Note



If necessary, it is possible to switch providers in order to make all features and functions of the product available.

From the main menu or after pressing **[M]** repeatedly, activate **Internet (Internet Radio)** mode on the radio.

7.1 Station search

This radio offers various ways to search for stations.

- Use **[NAVIGATE/ENTER/VOLUME]** to navigate through each search function and its options.
- Once you have found a station you like, confirm by pressing **[NAVIGATE/ENTER/VOLUME]**. The radio starts playing the selected station.



7.1.1 Search by country or region

To search for a station by continent, country and region, proceed as follows:

- Press [⚙️] (4) to access the Settings menu.
- Use [NAVIGATE/ENTER/VOLUME] (9) to navigate to the "Station list" menu item.
- Confirm the selection by pressing [NAVIGATE/ENTER/VOLUME].
- Use [NAVIGATE/ENTER/VOLUME] to navigate to the "Stations" menu item. Confirm the selection by pressing [NAVIGATE/ENTER/VOLUME].

Once you have restricted the results to a certain country or region, select a station from the complete list or from a list sorted by genre.

7.1.2 Search by genre

To search for a station of a certain genre or subject focus, proceed as follows:

- Press [⚙️] (4) to access the Settings menu.
- Use [NAVIGATE/ENTER/VOLUME] (9) to navigate to the "Station list" menu item.
- Confirm the selection by pressing [NAVIGATE/ENTER/VOLUME].
- Use [NAVIGATE/ENTER/VOLUME] to navigate to the "Stations" menu item. Confirm the selection by pressing [NAVIGATE/ENTER/VOLUME].

Once you have restricted the results to a certain genre, select a station from a list of all stations available, or from a pre-selected list, or from a list sorted by country.

7.1.3 Search by name

If you know the name of the desired station, you can search for it directly:

- Press [⚙️] (4) to access the Settings menu.
- Use [NAVIGATE/ENTER/VOLUME] (9) to navigate to the "Station list" menu item.
- Confirm the selection by pressing [NAVIGATE/ENTER/VOLUME].
- Use [NAVIGATE/ENTER/VOLUME] to navigate to the "Stations" menu item. Confirm the selection by pressing [NAVIGATE/ENTER/VOLUME].
- Use [NAVIGATE/ENTER/VOLUME] to navigate to the "Search stations" menu item. Confirm the selection by pressing [NAVIGATE/ENTER/VOLUME].

Enter the complete name, or a part thereof, in the input screen and select [OK] to start the search. You receive a list of all available stations whose names contain the search key.

7.1.4 Popular stations

You can find a selection of the most popular stations as follows:

- Press [⚙️] (4) to access the Settings menu.
- Use [NAVIGATE/ENTER/VOLUME] (9) to navigate to the "Station list" menu item.
- Confirm the selection by pressing [NAVIGATE/ENTER/VOLUME].
- Use [NAVIGATE/ENTER/VOLUME] to navigate to the "Stations" menu item. Confirm the selection by pressing [NAVIGATE/ENTER/VOLUME].
- Use [NAVIGATE/ENTER/VOLUME] to navigate to the "Popular stations" menu item and select your preferred station.

7.1.5 New stations

Stations that have recently been added to the database can be found as follows:

- Press [⚙️] (4) to access the Settings menu.
- Use [NAVIGATE/ENTER/VOLUME] (9) to navigate to the "Station list" menu item.
- Confirm the selection by pressing [NAVIGATE/ENTER/VOLUME].
- Use [NAVIGATE/ENTER/VOLUME] to navigate to the "Stations" menu item. Confirm the selection by pressing [NAVIGATE/ENTER/VOLUME].
- Use [NAVIGATE/ENTER/VOLUME] to navigate to the "New stations" menu item and select your preferred station.

7.1.6 Local stations

To search for stations from your own country (the country in which the radio is currently located), proceed as follows:

- Press [⚙️] (4) to access the Settings menu.
- Use [NAVIGATE/ENTER/VOLUME] (9) to navigate to the "Station list" menu item.
- Confirm the selection by pressing [NAVIGATE/ENTER/VOLUME].
- Use [NAVIGATE/ENTER/VOLUME] to navigate to the "Local <Country>" menu item. Confirm the selection by pressing [NAVIGATE/ENTER/VOLUME].
- Use [NAVIGATE/ENTER/VOLUME] to navigate to your preferred station.



Note



Replace the <Country> placeholder with the country you are currently located in.

You can filter this local list by genre, or select a station from the complete list, or select from a pre-selected list.

7.2 Podcasts

Podcasts are programs on various topics and include, for example, talk shows, news and much more. Podcasts can be downloaded from the Internet.

There are normally approximately 10,000 programs available. Similarly to radio stations, the radio makes it possible to filter a large number of Podcasts, or to search the entire database for a matching result.

7.2.1 Search by country or region

To search for a podcast by continent, country and region, proceed as follows:

- Press **[⚙️]** (4) to access the Settings menu.
- Use **[NAVIGATE/ENTER/VOLUME]** (9) to navigate to the "Station list" menu item.
- Confirm the selection by pressing **[NAVIGATE/ENTER/VOLUME]**.
- Use **[NAVIGATE/ENTER/VOLUME]** to navigate to the "Podcasts" menu item. Confirm the selection by pressing **[NAVIGATE/ENTER/VOLUME]**.
- Use **[NAVIGATE/ENTER/VOLUME]** to navigate to the "Location" menu item and select your preferred station.

Once you have restricted the results to a certain country or region, select a station from the complete list or from a list sorted by genre.

7.2.2 Search by format (subjects or categories)

To search for a podcast by continent, country and region, proceed as follows:

- Press **[⚙️]** (4) to access the Settings menu.
- Use **[NAVIGATE/ENTER/VOLUME]** (9) to navigate to the "Station list" menu item.
- Confirm the selection by pressing **[NAVIGATE/ENTER/VOLUME]**.

- Use **[NAVIGATE/ENTER/VOLUME]** to navigate to the "Podcasts" menu item. Confirm the selection by pressing **[NAVIGATE/ENTER/VOLUME]**.
- Use **[NAVIGATE/ENTER/VOLUME]** to navigate to the "Genre" menu item and select your preferred station.

7.2.3 Search by name

If you know the name of the desired Podcasts, you can search for it directly:

- Press **[⚙️]** (4) to access the Settings menu.
- Use **[NAVIGATE/ENTER/VOLUME]** (9) to navigate to the "Station list" menu item.
- Confirm the selection by pressing **[NAVIGATE/ENTER/VOLUME]**.
- Use **[NAVIGATE/ENTER/VOLUME]** to navigate to the "Podcasts" menu item. Confirm the selection by pressing **[NAVIGATE/ENTER/VOLUME]**.
- Use **[NAVIGATE/ENTER/VOLUME]** to navigate to the "Search podcasts" menu item.

Enter the complete podcast name, or a part thereof, in the input screen and select **[OK]** to start the search. You receive a list of all available Podcasts whose names contain the search key.

7.3 Last listened

The radio saves the last stations and podcasts listened to in their own list. To access the list, proceed as follows:

- Press **[⚙️]** (4) to access the Settings menu.
- Use **[NAVIGATE/ENTER/VOLUME]** (9) to navigate to the "Last listened" menu item.
- Confirm the selection by pressing **[NAVIGATE/ENTER/VOLUME]**.

7.4 Favourites (local)

You can save up to 30 of your favourite stations for quick and direct access.



7.4.1 Assigning the Presets shortcut buttons

- Set the station that you would like to save as a favourite station preset.
- Once the station is playing, press and hold the relevant shortcut button for around 3 seconds.
- The selection will be confirmed by the display showing "Preset (1-4, depending on shortcut key) stored".
- During playback, the Preset memory slot is displayed at the right-hand edge of the screen.

Note

Favourites cannot be deleted. If all 30 station memory slots are filled and you wish to save a new station, choose one of the occupied slots. The station in this slot will be overwritten with the new station.

7.4.2 Calling up shortcut button presets

To call up a preset station, press the corresponding shortcut button (2-5).

7.4.3 Assigning the list of presets (1-30)

- Set the station that you would like to save as a favourite station preset.
- If the stations is playing, press and hold [F] (3) for approx. 3 seconds until the Presets list opens up.
- Navigate to the preferred memory slot and confirm your selection by pressing [NAVIGATE/ENTER/VOLUME] (9).
- The selection will be confirmed by the display showing "Preset (1-30, depending on storage space) stored".

7.4.4 Calling up a station from the Presets list (1-30)

- Press [F] to call up the Presets list.
- Use [NAVIGATE/ENTER/VOLUME] (9) to navigate to the preferred station and confirm your selection by pressing [NAVIGATE/ENTER/VOLUME].

7.5 Presets

(vTuner – <http://www.wifiradio-frontier.com>)

In addition to the local station memory slots, you can create additional lists of favourites using the vTuner database.

Lists of favourites created using the vTuner database can be synchronised across multiple radios.

7.5.1 First use – Registering your radio

In order to be able to use this function you have to register at www.wifiradio-frontier.com. You need a valid email address and an access code which will be generated by your radio.

Note

- No personal information is collected during the registration process.
- Registering does not cost you anything extra. The offer is completely free.
- Following registration you can choose from around 20,000 radio stations and 10,000 podcasts and manage these in Presets lists.

Get access code:

- Press [G] (4) to access the SETTINGS menu.
- Use [NAVIGATE/ENTER/VOLUME] (9) to navigate to the "Station list" menu item.
- Confirm the selection by pressing [NAVIGATE/ENTER/VOLUME].
- Use [NAVIGATE/ENTER/VOLUME] to navigate to the "Help" menu item. Confirm the selection by pressing [NAVIGATE/ENTER/VOLUME].
- Use [NAVIGATE/ENTER/VOLUME] to navigate to the "Get access code" menu item.

Note

Please note that each access code can only be used once. Please contact customer service if you should experience problems while registering the radio.

- During registration, the radio's ID is associated with your e-mail address and saved in the web interface.
- If multiple radios are registered to you and you wish to delete one of those registrations or just compare them, you can find the radio's ID as follows:
- Press [G] (4) to go to the system settings.
- Use [NAVIGATE/ENTER/VOLUME] (9) to navigate to the "Info" menu item.
- Confirm the selection by pressing [NAVIGATE/ENTER/VOLUME].

The radio ID can now be viewed on the display.



7.5.2 Managing presets online

(vTuner – <http://www.wifiradio-frontier.com>)

After registering on the portal, you can search through the station archive using various filters, try out stations, and create your own favourites list from the stations listed there. The favourites list is then synchronised with your radio in seconds.

7.5.3 Opening the favourites list

To open the favourites list you created on the portal using the radio, proceed as follows:

- Press [⚙️] (4) to access the Settings menu.
- Use [NAVIGATE/ENTER/VOLUME] (9) to navigate to the "Station list" menu item.
- Confirm the selection by pressing [NAVIGATE/ENTER/VOLUME].
- Use [NAVIGATE/ENTER/VOLUME] to navigate to the "My Favourites" menu item. Confirm the selection by pressing [NAVIGATE/ENTER/VOLUME].

7.5.4 My Added Stations

If a station you desire is not yet available, you can add it manually to the portal (Only available on your device), or suggest a station be added to the database (Recommend station).

- You need the web address of the stream, which can often be found on the station's website.
- You can access the manually added radio stations as follows:
- Press [⚙️] (4) to access the Settings menu.
- Use [NAVIGATE/ENTER/VOLUME] (9) to navigate to the "Station list" menu item.
- Confirm the selection by pressing [NAVIGATE/ENTER/VOLUME].
- Use [NAVIGATE/ENTER/VOLUME] to navigate to the "My Added Stations" menu item. Confirm the selection by pressing [NAVIGATE/ENTER/VOLUME].

The database is constantly expanded and maintained. Nevertheless, we hope you'll understand that sometimes there can be delays in integrating new stations and some stations are even rejected.

8. Music player

This operating mode enables the playback of MP3, WMA or FLAC files stored on a PC or local network.

From the main menu or after pressing [M] repeatedly, activate **Music player** mode on the radio.

8.1 Playback from a computer (streaming)

You can manage the radio and stream music to it from your computer.

The following explanation assumes your computer's operating system is Windows 8. If you use a different operating system, or if you have any other questions, please contact our customer support team.

Requirements:

- The radio and the computer must be on the same network.
- The radio must be authorised as a playback device on the computer.

Proceed as follows:

-> **Control Panel -> Network and Internet -> Show network computers and devices**

The radio should be shown here.

- Right-click on the icon or designation of the radio and choose **Allow streaming to this device**.
- Right-click again on the icon or designation of the radio and choose **Show device website** to change the friendly name of the device.
- A new browser window opens. You can make the desired changes here.

Use:

- The radio can now access shared directories on the computer, and you can stream audio files to the device for playback (streaming).
- The music directory of your music library is enabled as standard.
- Create and manage shared folders using Explorer or Windows Media Player.
- Right-click on the desired music file, choose **Play To**, and then select the designation of the radio.
- The radio begins playback of the music file.



8.2 Playback from the network – Accessing files using the radio

To access one of the existing network shared files directly from the radio, proceed as follows:

From the main menu or after pressing [M] repeatedly, activate **Music player** mode on the radio:

- Press [⚙️] (4) to access the Settings menu.
- Use [NAVIGATE/ENTER/VOLUME] (9) to navigate to the "Music player" menu item.
- Confirm the selection by pressing [NAVIGATE/ENTER/VOLUME].
- Use [NAVIGATE/ENTER/VOLUME] to navigate to the "Shared media" menu item. Confirm the selection by pressing [NAVIGATE/ENTER/VOLUME].
- Choose the correct device (home server, PC, etc.) and press [NAVIGATE/ENTER/VOLUME] to open the list of shared folders on that device.

You can now search for files, open a playlist, or search through the entire shared music folders. If you want to search through the entire selection of music, there are other sorting functions available (Album, Artist, Genre, Folder, etc.) that can help you find the desired file more quickly.

Note

These functions are only available if the ID3 tag and other file information have been maintained on the source device.

Prune servers:

To reset the list of servers connected to so far, press [NAVIGATE/ENTER/VOLUME].

If you confirm by choosing **YES**, then all shared media will be deleted.

8.3 Playback of playlist

You can create a local playlist on the radio, in which you save files shared on the network or from connected data storage devices.

- Choose the file to be added to the playlist (under **Shared media**).
- Press and hold [NAVIGATE/ENTER/VOLUME] for approx. 3 seconds until the display shows the message **Added to playlist**.

Note

You can also use playlists that were created on your Windows PC. (WPL = Windows Playlist). For example, Windows Media Player is suited for this purpose.

To go directly to the playlist, do as follows:

- Press [⚙️] (4) to access the Settings menu.
- Use [NAVIGATE/ENTER/VOLUME] (9) to navigate to the "Music player" menu item.
- Confirm the selection by pressing [NAVIGATE/ENTER/VOLUME].
- Use [NAVIGATE/ENTER/VOLUME] to navigate to the "My Playlist" menu item. Confirm the selection by pressing [NAVIGATE/ENTER/VOLUME]. The playlist is now played.
- To remove individual files from the playlist, choose the file and then press and hold [NAVIGATE/ENTER/VOLUME] for approx. 3 seconds.
- Confirm **Delete from my playlist** by choosing **YES** to delete the file from the playlist.
- To delete the entire playlist, proceed as follows:
 - Press [⚙️] (4) to access the Settings menu.
 - Use [NAVIGATE/ENTER/VOLUME] (9) to navigate to the "Music player" menu item.
 - Confirm the selection by pressing [NAVIGATE/ENTER/VOLUME].
 - Use [NAVIGATE/ENTER/VOLUME] to navigate to the "Clear My playlist" menu item. Confirm the selection by pressing [NAVIGATE/ENTER/VOLUME].
 - Confirm the prompt querying if you want to delete the playlist with **YES**.

8.4 General playback options

These playback options, which are valid for all playback under Music player, can be found here:

- Press [⚙️] (4) to access the Settings menu.
- Use [NAVIGATE/ENTER/VOLUME] (9) to navigate to the "Repeat play/Shuffle play" menu item. Confirm the selection by pressing [NAVIGATE/ENTER/VOLUME].



Repeat: On / Repeat: Off

To switch the function (**On / Off**), repeatedly press **[NAVIGATE/ENTER/VOLUME]**. With **Repeat: On**, only the current track is repeated.

Shuffle: On / Shuffle: Off

To switch the function (**On / Off**), repeatedly press **[NAVIGATE/ENTER/VOLUME]**. With **Shuffle: On**, all tracks are played in a random order.

9. Digital radio (DAB/DAB+)

The radio receives all established digital radio frequencies in the range of 174 MHz to 240 MHz (band III, channel 5A to 13F).

From the main menu or after pressing **[M]** repeatedly, activate operating mode **DAB (DAB Radio)** on the radio.

9.1 Search / Automatic search

The automatic DAB channel search scans the DAB band III for available stations. After the station search, all interference-free stations are saved in alphabetical order. In Stations list a ? is displayed in front of the station names of stations found during a previous scan but which cannot currently be received.

The automatic DAB station search starts automatically when DAB mode is started for the first time; it is indicated by **Scanning...** and a status bar on the display.

If you would like to start the search again, proceed as follows:

- Press **[⚙️]** (4) to access the Settings menu.
- Use **[NAVIGATE/ENTER/VOLUME]** (9) to navigate to the "Scan" menu item.
- Confirm the selection by pressing **[NAVIGATE/ENTER/VOLUME]**.
- Wait until the search process has completed.
- The available stations are now displayed in the list of stations.

9.2 Station list

You can call up the station list in DAB mode at any time. To do so, proceed as follows:

- Press **[↶]** (7) during playback to navigate through the available stations in ascending alphabetical order using **[NAVIGATE/ENTER/VOLUME]**.
- Confirm the selection by pressing **[NAVIGATE/ENTER/VOLUME]**.
- The device starts playback automatically.

Note



The list of stations contains all stations that were found on the last station search. A further station search - as described in **9.1 Search / Automatic search** - can be started. A station's reception quality depends on factors such as the weather, location and orientation of the aerial. If a station shown in the list of stations is not available, changing the orientation of the aerial or the location of the radio may help. Stations that are not available can be removed from the list of stations as described in **9.3 Edit station list**.

9.3 Edit station list

To remove stations that are not currently in the reception area, from your station list, proceed as follows:

- Press **[⚙️]** (4) to access the Settings menu.
- Use **[NAVIGATE/ENTER/VOLUME]** (9) to navigate to the "Prune invalid" menu item.
- Confirm the selection by pressing **[NAVIGATE/ENTER/VOLUME]**.

If you answer **YES**, then all currently unavailable stations will be removed from the station list.

Note



To keep the list of stations up to date, we recommend updating the list regularly with a full station search (see **9.1 Search / Automatic search**).

9.4 Presets

You can save up to 30 of your favourite stations for quick and direct access.

9.4.1 Assigning the Presets shortcut buttons

- Set the station that you would like to save as a favourite station preset.
- Once the station is playing, press and hold the relevant shortcut button for around 3 seconds.
- The selection will be confirmed by the display showing "Preset (1-4, depending on shortcut key) stored".
- During playback, the Preset memory slot is displayed at the right-hand edge of the screen.



Note



Favourites cannot be deleted. If all 30 station memory slots are filled and you wish to save a new station, choose one of the occupied slots. The station in this slot will be overwritten with the new station.

9.4.2 Calling up shortcut button presets

To call up a preset station, press the corresponding shortcut button (2-5).

9.4.3 Assigning the list of presets (1-30)

- Set the station that you would like to save as a favourite station preset.
- If the station is playing, press and hold **[H]** (3) for approx. 3 seconds until the Presets list opens up.
- Navigate to the preferred memory slot and confirm your selection by pressing **[NAVIGATE/ENTER/VOLUME]**.
- The selection will be confirmed by the display showing "Preset (1-30, depending on storage space) stored".

9.4.4 Calling up a station from the Presets list (1-30)

- Press **[H]** to call up the Presets list.
- Use **[NAVIGATE/ENTER/VOLUME]** to navigate to the preferred station and confirm your selection by pressing **[NAVIGATE/ENTER/VOLUME]**.

9.5 DRC (Dynamic Range Control)

Some DAB network radio stations support a volume control feature that actively takes effect during playback. If the volume suddenly increases, DRC automatically lowers it. If the volume suddenly becomes quieter, DRC automatically raises it. The same happens when playback is suddenly quiet. The radio then increases the volume again.

DRC high: total equalisation of different volumes. Strong compression can audibly reduce the dynamics of a music title.

DRC low: partial equalisation of different volumes. More subtle compression, without too much loss of dynamics.

DRC off: no equalisation

Proceed as follows to do the settings:

- Press **[⚙]** (4) to access the Settings menu.
- Use **[NAVIGATE/ENTER/VOLUME]** (9) to navigate to the "DRC" menu item.
- Confirm the selection by pressing **[NAVIGATE/ENTER/VOLUME]** and choose your preferred setting.

9.6 Station sequence

By default the radio sorts stations into alphabetical order. You can also sort by signal strength or ensemble. To change the sorting order, proceed as follows:

- Press **[⚙]** (4) to access the Settings menu.
- Use **[NAVIGATE/ENTER/VOLUME]** (9) to navigate to the "Station order" menu item.
- Choose between "Alphanumeric", "Ensemble" and "Valid" and confirm your selection by pressing **[NAVIGATE/ENTER/VOLUME]**.

10. FM

From the main menu or after pressing **[M]** repeatedly, activate operating mode **FM (FM Radio)** on the radio.

Stations that broadcast additional information regarding the station and the programme, are highlighted on the display with an RDS icon (Radio Data System). This additional information is displayed by pressing **[i]**.

10.1 Scan setting

The search run setting allows you to determine whether stations with low signal strength are ignored during the automatic search run. Proceed as follows:

- Press **[⚙]** (4) to access the Settings menu.
- Use **[NAVIGATE/ENTER/VOLUME]** (9) to navigate to the "Scan setting" menu item.
- Confirm the selection by pressing **[NAVIGATE/ENTER/VOLUME]**.
- To have the search run stop only at stations with high signal strength, select **Strong stations only**. Otherwise, the search run will stop at every station for which a signal is received.



Note



By default, the "Strong stations only" method is selected.

10.2 Search / Automatic search

- Press [NAVIGATE/ENTER/VOLUME] to start a station search.
- The radio stops the search and starts playback when it finds a station.
- Press [NAVIGATE/ENTER/VOLUME] again to continue the search until the next station is found.

10.3 Presets

You can save up to 30 of your favourite stations for quick and direct access.

10.3.1 Assigning the Presets shortcut buttons

- Set the station that you would like to save as a favourite station preset.
- Once the station is playing, press and hold the relevant shortcut button for around 3 seconds.
- The selection will be confirmed by the display showing "Preset (1-4, depending on shortcut key) stored".
- During playback, the Preset memory slot is displayed at the right-hand edge of the screen.

Note



Favourites cannot be deleted. If all 30 station memory slots are filled and you wish to save a new station, choose one of the occupied slots. The station in this slot will be overwritten with the new station.

10.3.2 Calling up shortcut button presets

To call up a preset station, press the corresponding shortcut button (2-5).

10.3.3 Assigning the list of presets (1-30)

- Set the station that you would like to save as a favourite station preset.
- If the station is playing, press and hold [H] (3) for approx. 3 seconds until the Presets list opens up.
- Navigate to the preferred memory slot and confirm your selection by pressing [NAVIGATE/ENTER/VOLUME] (9).
- The selection will be confirmed by the display showing "Preset (1-30, depending on storage space) stored".

10.3.4 Calling up a station from the Presets list (1-30)

- Press [H] to call up the Presets list.
- Use [NAVIGATE/ENTER/VOLUME] (9) to navigate to the preferred station and confirm your selection by pressing [NAVIGATE/ENTER/VOLUME].

10.4 Audio setting

For some stations with a weak signal, quality can be slightly improved by playing them in mono quality. You can enable this function in the menu, and the radio will automatically switch to mono reception when signal quality is poor. To change the audio setting, proceed as follows:

- Press [G] (4) to access the Settings menu.
- Use [NAVIGATE/ENTER/VOLUME] (9) to navigate to the "Audio setting" menu item.
- Confirm the selection by pressing [NAVIGATE/ENTER/VOLUME] and choose your preferred setting.

11. Sleep

The radio has a timer function, which switches the radio to standby mode after a pre-defined length of time, regardless of its operating mode.

- Press [G] (4) to access the Settings menu.
- Use [NAVIGATE/ENTER/VOLUME] (9) to navigate to the "Main menu" menu item.
- Confirm the selection by pressing [NAVIGATE/ENTER/VOLUME].
- Use [NAVIGATE/ENTER/VOLUME] to navigate to the "Sleep" menu item.
- You can set the timer value with [NAVIGATE/ENTER/VOLUME].
- Confirm the setting by pressing [NAVIGATE/ENTER/VOLUME].
- If the sleep timer is activated, this is indicated in the playback screen by [Z^z].



12. Alarms

The Radio has two individually adjustable alarm times.

12.1 Alarm settings

You can access the alarm settings as follows:

- Press  (4) to access the Settings menu.
- Use **[NAVIGATE/ENTER/VOLUME]** (9) to navigate to the "Main menu" menu item.
- Confirm the selection by pressing **[NAVIGATE/ENTER/VOLUME]**.
- Use **[NAVIGATE/ENTER/VOLUME]** to navigate to the "Alarms" menu item.

Alarm 1 and alarm 2 are configured identically and allow two separate alarm times to be saved. Choose Alarm 1 or 2 and confirm your selection by pressing **[NAVIGATE/ENTER/VOLUME]**.

Set the following details using **[NAVIGATE/ENTER/VOLUME]**.

Mode:

Choose when the alarm is to activate:

Off – Daily – Once – Weekdays – Weekends

Time:

First choose the hour, then the minute at which the alarm is to activate.

Mode:

Set whether you wish to be woken by an alarm tone (buzzer), by **DAB, FM** or by the **Internet radio**.

Program:

If you selected **Internet radio/ DAB/ FM**, choose which station you wish to be woken with. You can choose any of the 30 preset slots or the **Last listened**.

Volume:

You can set the volume at which the alarm sound should be played. This setting makes it irrelevant how loud you last listened to the radio.

Saving:

Select **Off / On** to complete your alarm settings.

Note



It is recommended to allow the radio to update the time automatically. This ensures that the time is always correct even if there is a separation of power supply – for example a power cut.

12.2 Activating / deactivating the alarm

- Confirm the menu item **Save** in alarm settings to activate the alarm.
- Disable the alarm by setting the **Mode** to **Off**.

12.3 Stopping the alarm/ Snooze function

- When the alarm activates, press  to stop the alarm.
- When the alarm activates, press **[NAVIGATE/ENTER/VOLUME]** to enable snooze.
- The alarm turns off for the selected time interval (5/10 minutes) before activating once again.

13. System settings

You can modify all settings and access important information about the radio in the System settings.

13.1 Network

13.1.1 Network wizard – Configuration of Internet connection / Search

The **network wizard** helps you set up a connection between the radio and the Internet. More methods of configuration and detailed information are amplified subsequently.

- You can start the **Network wizard** as follows:

- Press  (4) to go to the system settings.
- Use **[NAVIGATE/ENTER/VOLUME]** (9) to navigate to the "Network" menu item.
- Confirm the selection by pressing **[NAVIGATE/ENTER/VOLUME]**.
- Use **[NAVIGATE/ENTER/VOLUME]** to navigate to the "Network wizard" menu item.



- When the wizard is started, the radio searches for WLAN (WiFi) connections and then shows a list of the available networks.
- Turn **[NAVIGATE/ENTER/VOLUME]** to switch amongst the networks discovered. At the bottom of the list are options to restart the search ("[Rescan]") or configure the connection yourself ("[Manual config]").
- If your network is not found or the SSID (Service Set Identification, that is, the name of your network) is not shown, the network may be hidden or out of range. In this case, try manual configuration.

13.1.2 Wireless network connection (WLAN)

Depending on the network, there are a number of ways to connect to it.

Networks that support connection via WPS (Wi-Fi Protected Setup) are identified in the list with the prefix "[WPS]".

Other connections are either open networks or connections protected with a PSK, or Pre-Shared-Key.

WPS / PSK / open network connection

WPS allows simple and nevertheless protected connection of the radio to the network. Two options are available for this purpose:

The connection can be set up by means of PBC, or Push-Button Configuration, or by the PIN procedure, in which the web interface of your router prompts you to enter a randomly generated sequence of numbers.

PBC setup

- Select your desired network. (Indicated by the prefix "[WPS...]")
- In the WPS menu, choose the "Push Button" option and confirm your selection by pressing **[NAVIGATE/ENTER/VOLUME]**.
- Press the WPS button on your router or current access point. This can often be done using the web interface, as well.
- Consult the operating instructions of your router or access point for details.
- Once the process has been started on the router or access point, the radio should be able to find and connect to the network.
- Alternatively, PBC setup can be initiated from the radio's Internet settings:

- Press **[⚙️]** (4) to go to the system settings.
- Use **[NAVIGATE/ENTER/VOLUME]** (9) to navigate to the "Network" menu item.
- Confirm the selection by pressing **[NAVIGATE/ENTER/VOLUME]**.
- Use **[NAVIGATE/ENTER/VOLUME]** to navigate to the "PBC Wlan setup" menu item.

PIN setup

- Select your desired network. (Indicated by the prefix "[WPS...]")
- In the WPS menu, choose the PIN option and confirm your selection by pressing **[NAVIGATE/ENTER/VOLUME]**.
- The radio generates an 8-digit code, which must be entered into the web or user interface of your router or access point.
- Consult the corresponding handbook for details on configuring the router or access point.

Skip WPS / Pre-Shared Key (PSK) configuration

- Choose the item "Skip WPS" to proceed to key entry.
- On networks that do not support WPS, you will go directly to key entry.
- In the input screen, enter the whole key and then confirm with the **OK** button.
- If the key was entered correctly, the radio connects to the access point and establishes the Internet/network connection.

Note

- Often the Pre-Shared Key is printed on the back of the router or access point.
- When entering the key, take notice of capitalisation.

Open network / unsecured network

Note

- We recommend against establishing unsecured connections and advise you to always protect your network against unauthorised access.
- If you plan to use an open network, you just have to select the network from the list of available networks and confirm. The radio then connects immediately with the access point.



13.1.3 Manual configuration of network connection – wireless (WLAN)

- To manually configure a network connection, proceed as follows:
- Press [⚙️] (4) to go to the system settings.
- Use [NAVIGATE/ENTER/VOLUME] to navigate to the "Network" menu item.
- Confirm the selection by pressing [NAVIGATE/ENTER/VOLUME].
- Use [NAVIGATE/ENTER/VOLUME] to navigate to the "Manual settings" menu item.

Manual configuration wireless (WLAN) – DHCP enable

- Select the option "Wireless".
- Selection the option "DHCP enable".
- In the input screen, enter the whole SSID (network name) and then confirm with the **OK** button.
- Now choose the security standard used by the network. This can be found in the configuration options of your router or access point.
- Depending on the encryption used, you may need to enter the network key before the connection is established.

Manual configuration wireless (WLAN) – DHCP disable

This method corresponds to configuration with an active DHCP server (**manual configuration wireless (WLAN) - DHCP enable**), however you must also enter the network information such as the IP address, subnet mask, gateway address and DNS (primary and secondary). Find this information in the web interface of your router or access point, or if this information is already correctly entered, you can confirm the entry. The radio now attempts to establish the connection.

13.1.4 View settings

This is where you will find all of the key information about all network connections that the radio is currently using, or which have been set up, e.g.: MAC address, WLAN region, DHCP enable / disable, SSID, IP address, subnet mask, gateway address, DNS (primary/secondary), etc.

- Press [⚙️] (4) to go to the system settings.
- Use [NAVIGATE/ENTER/VOLUME] (9) to navigate to the "Network" menu item.
- Confirm the selection by pressing [NAVIGATE/ENTER/VOLUME].
- Use [NAVIGATE/ENTER/VOLUME] to navigate to the "View settings" menu item.

13.1.5 Network profile

The radio automatically saves all successful network connections (profiles). This means that re-establishing these connections (for example, after the radio was disconnected from the power supply) does not require you to re-enter the network access information.

To remove network profiles individually, proceed as follows:

- Press [⚙️] (4) to go to the system settings.
- Use [NAVIGATE/ENTER/VOLUME] (9) to navigate to the "Network" menu item.
- Confirm the selection by pressing [NAVIGATE/ENTER/VOLUME].
- Use [NAVIGATE/ENTER/VOLUME] to navigate to the "Network profile" menu item.

- Select a network profile and press [NAVIGATE/ENTER/DELETE] to remove it.
- Confirm the prompt querying if you want to delete the network profile with **YES**.
- A profile that is currently active, or that is in use, cannot be deleted.

Note



- Before giving or selling the radio to someone else, we recommend performing a factory reset.
- This will completely and permanently delete all network information and connections stored on the device.



13.2 Time/ Date settings

To access the time settings, proceed as follows:

- Press [⚙️] (4) to go to the system settings.
- Use [NAVIGATE/ENTER/VOLUME] (9) to navigate to the "Time/Date" menu item.
- Confirm the selection by pressing [NAVIGATE/ENTER/VOLUME].
- Use [NAVIGATE/ENTER/VOLUME] to navigate to the "Auto update" menu item.

Auto update

Update from Internet

Choose this option to set the time and date automatically from the internet. Set the timezone of your current location (**Set timezone**) and, if desired, turn on automatic adjustment between summer time and winter time (**Daylight savings -> ON**).

Update from DAB / FM

If automatic time and date adjustment is activated, the device receives time and date information from the station over the FM/DAB/DAB+ radio network. This is the best way to ensure that the clock will run accurately and the alarm will trigger at the correct time, even after power outages.

No update

The time and date (**DD-MM-YYYY**) must be set manually; no automatic calibration takes place.

Time/ Date settings

Set the date (**DD-MM-YYYY**) and time (**hh:mm**) manually using [NAVIGATE/ENTER/VOLUME].

Format

Choose between 12 and 24 hours format.

13.3 Language

The first time it is used, the radio's default language is English. To change radio's menu language, proceed as follows:

- Press [⚙️] (4) to go to the system settings.
- Use [NAVIGATE/ENTER/VOLUME] to navigate to the "Language" menu item. Confirm the selection by pressing [NAVIGATE/ENTER/VOLUME].
- Use [NAVIGATE/ENTER/VOLUME] to select your preferred system language.
- The language setting currently selected is marked with an asterisk (*).

Note

The following languages are available:
Czech, English, Danish, Dutch, German, Finnish, French, Italian, Norwegian, Polish, Portuguese, Slovak, Spanish, Swedish and Turkish.

13.4 Factory Reset

To reset the radio to the factory default settings, proceed as follows:

- Press [⚙️] (4) to go to the system settings.
- Use [NAVIGATE/ENTER/VOLUME] (9) to navigate to the "Factory reset" menu item.
- Confirm the following prompt with **YES** to reset the radio to the factory default settings. All settings made previously are deleted.
- To abort the deletion process, press [↩️] or select **NO**.

Note

Resetting to the factory default settings can solve some problems and malfunctions.

- However, all settings made previously, such as equaliser and presets, permanently deleted.



13.5 Software update

Improvements and new features are always constantly being developed for the software used in our radios to resolve potential errors, increase the range of functions, and so on. We recommend that you always install any available updates on your radio.

Proceed as follows:

- Press  (4) to go to the system settings.
- Use **[NAVIGATE/ENTER/VOLUME]** to navigate to the "Software update" menu item.
- Select **Automatic updates (YES)** to allow the radio to automatically check for new software updates on a regular basis. (Recommendation)
- Choose **Check now** to manually start a check for software updates.

Warning



- Make sure that the radio has a stable power supply before you start a software update.
- Power supply failure during a software update can cause irreparable damage to the radio.

13.6 Info

To check the current software version, radio ID and device designation of your radio, proceed as follows:

- Press  (4) to go to the system settings.
- Use **[NAVIGATE/ENTER/VOLUME]** (9) to navigate to the "Info" menu item.
- Confirm the selection by pressing **[NAVIGATE/ENTER/VOLUME]**.

Note



If you require assistance from customer support, please let the agent know the current software version. Problems are frequently resolved through software updates, and your query may be resolved by comparing your software version with the last software version available.

If updates are available, these can be found at www.hama.com with the corresponding article number or designation of the radio. You may find update instructions in the article's download area.

13.7 Lighting

The backlight can be configured for each operating mode (Operation Mode, Standby Mode) separately.

Proceed as follows:

- Press  (4) to go to the system settings.
- Use **[NAVIGATE/ENTER/VOLUME]** (9) to navigate to the "Beleuchtung" menu item.
- Confirm the selection by pressing **[NAVIGATE/ENTER/VOLUME]**.
- You can set the brightness with **[NAVIGATE/ENTER/VOLUME]**.

Note



The choice of lighting mode impacts on the power consumption.



14. Care and Maintenance

- Only clean this product with a slightly damp, lint-free cloth and do not use aggressive cleaning agents.
- If you do not use the product for a long time, turn off the device and disconnect it from the power supply. Store it in a clean, dry place out of direct sunlight.

15. Warranty Disclaimer

Hama GmbH & Co KG assumes no liability and provides no warranty for damage resulting from improper installation/ mounting, improper use of the product or from failure to observe the operating instructions and/ or safety notes.

16. Recycling Information

Note on environmental protection:



After the implementation of the European Directives 2012/19/EU and 2006/66/EU in the national legal system, the following applies:

Electric and electronic devices as well as batteries must not be disposed of with household waste. Consumers are obliged by law to return electrical and electronic devices as well as batteries at the end of their service lives to the public collecting points set up for this purpose or point of sale. Details to this are defined by the national law of the respective country. This symbol on the product, the instruction manual or the package indicates that a product is subject to these regulations. By recycling, reusing the materials or other forms of utilising old devices/ batteries, you are making an important contribution to protecting our environment.

17. Declaration of Conformity

CE Hama GmbH & Co KG hereby declares that the radio equipment type [00054873] is in compliance with Directive 2014/53/EU. The full text of the EU declaration of conformity is available at the following internet address:
www.hama.com -> 00054873 -> Downloads.

Frequency band(s)	WiFi: 2.412 - 2.472 GHz WiFi: 5.150 - 5.350 GHz WiFi: 5.470 - 5.725 GHz
Maximum radio-frequency power transmitted	WiFi: 2.4GHz / 17dBm (EIRP) WiFi: 5GHz / 16.5dBm (EIRP)

Restrictions or Requirements in

Belgium, Bulgaria, Czech Republic, Denmark, Germany, Estonia, Ireland, Greece, Spain, France, Croatia, Italy, Cyprus, Latvia, Lithuania, Luxembourg, Hungary, Malta, the Netherlands, Austria, Poland, Portugal, Romania, Slovenia, Slovakia, Finland, Sweden, United Kingdom

Note

If channels 36-64 (channels of frequency 5150 MHz - 5350 MHz) are used, the device may only be used in closed rooms.





hama®

Hama GmbH & Co KG
86652 Monheim / Germany

Service & Support

 www.hama.com

 +49 9091 502-115

D

GB

All listed brands are trademarks of the corresponding companies. Errors and omissions excepted, and subject to technical changes. Our general terms of delivery and payment are applied.

00054873 / 07.18