

Liquid Freezer III 360

Multikompatibler All-in-One CPU-Wasserkühler



Allgemeine Spezifikationen

Kompatibilität	Intel® LGA1851, LGA1700 AMD® AM5, AM4
PI NNPI	338 309
Wärmeleitpaste	MX-6 (0,8g)
Garantie	6 Jahre
Betriebsumgebungstemperatur	0-40°C
Gewicht	1840g
All-In-One-Anschluss	4-Pin-PWM-Buchse

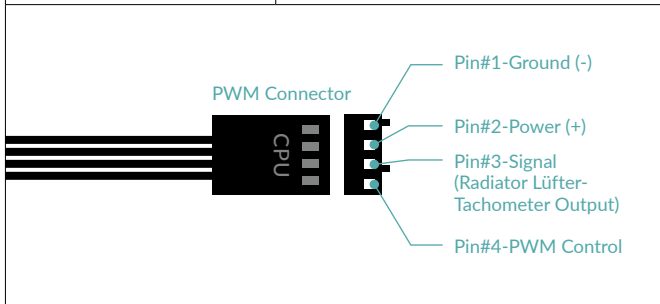

Geteilter Anschluss	3x 4-Pin-PWM-Buchse
---------------------	---------------------

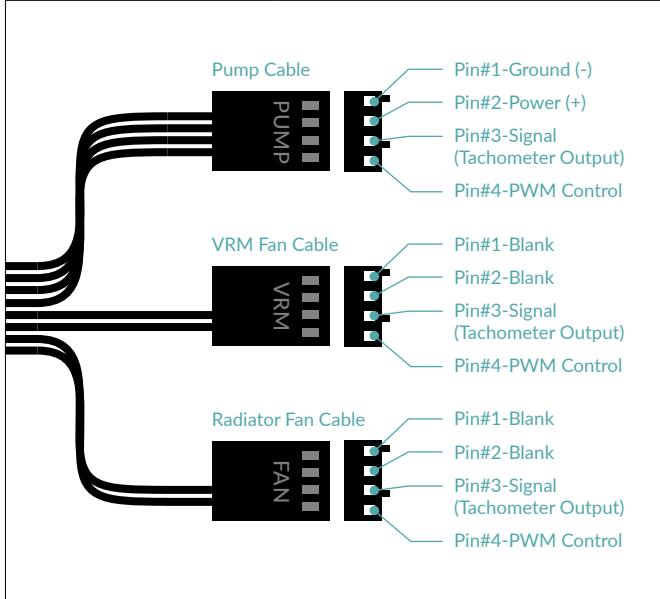

Pumpe	800-2800rpm (PWM-gesteuert)
Strom Spannung	0,35A 12VDC
Cold Plate	Kupfer, Micro-Skived-Fins
Schlauchlänge	450mm
Schlauchdurchmesser	Äußerer: 12,4mm Innerer: 6,0mm
Radiator	
Material	Aluminium
Abmessungen	398 (L) x 120 (B) x 38 (H) mm
VRM-Modul	
VRM-Lüfter	400-2500rpm (PWM-gesteuert)
Strom Spannung	0,05A 12VDC

Radiatorlüfter-Spezifikationen

Allgemein	3x P12 PWM
Geschwindigkeit	200-1800rpm
Luftstrom	56,30cfm 95,65m³/h
Statischer Druck	2,20mmH₂O
Lager	Hydrodynamisches Gleitlager
Strom Spannung	0,10A 12VDC
Kabellänge	40mm
Anschluss	4-Pin-PWM-Buchse

Versandinformationen - LF III 360 (Black)

Box Abmessungen	414 (L) x 167 (B) x 142 (H) mm
Brutto Gewicht	2375g
SKU	ACFRE00136A
EAN	4895213704489
UPC	840033402255

Liquid Freezer III 360

Multikompatibler All-in-One CPU-Wasserkühler

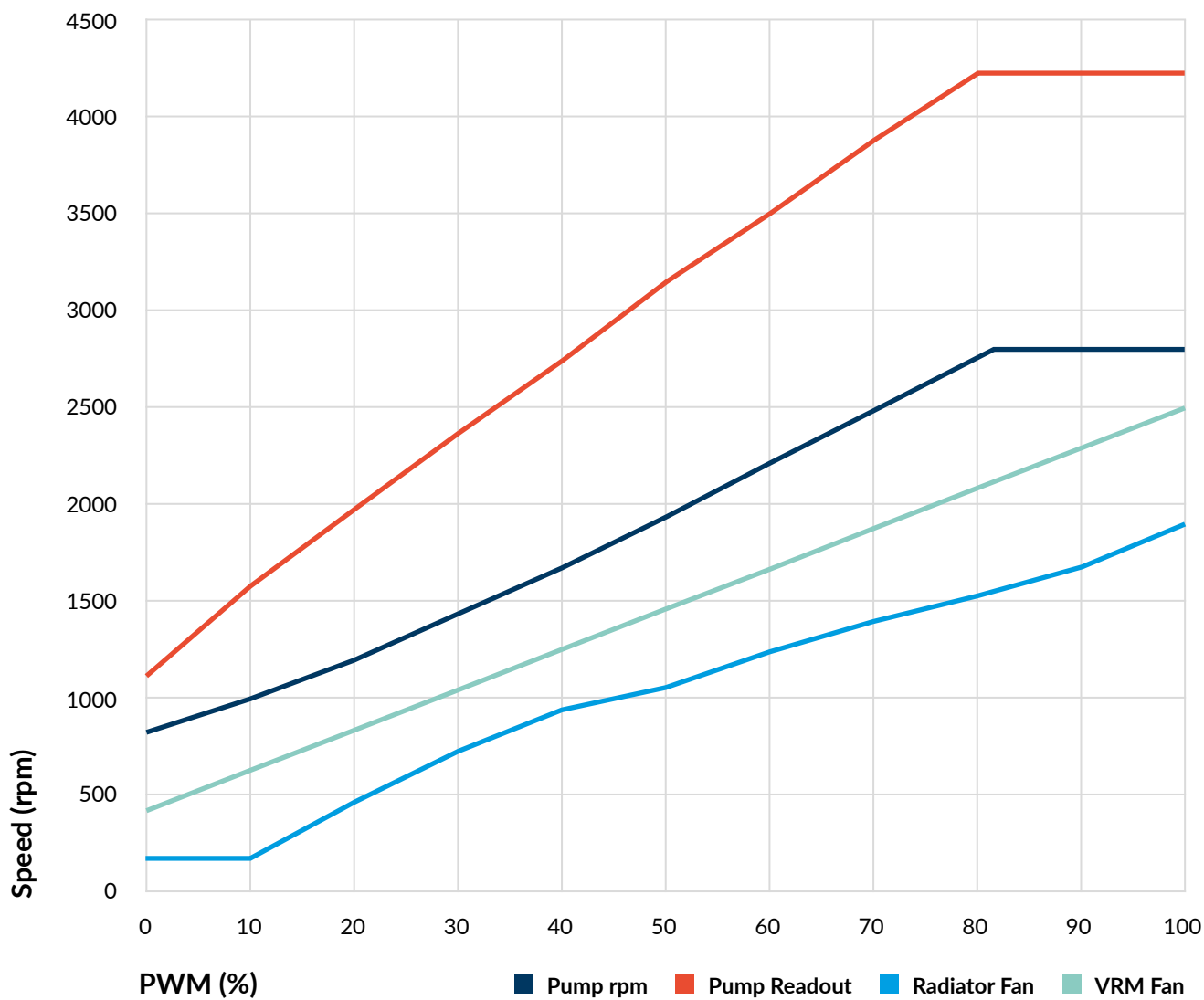

Liquid Freezer III 360

Multikompatibler All-in-One CPU-Wasserkühler

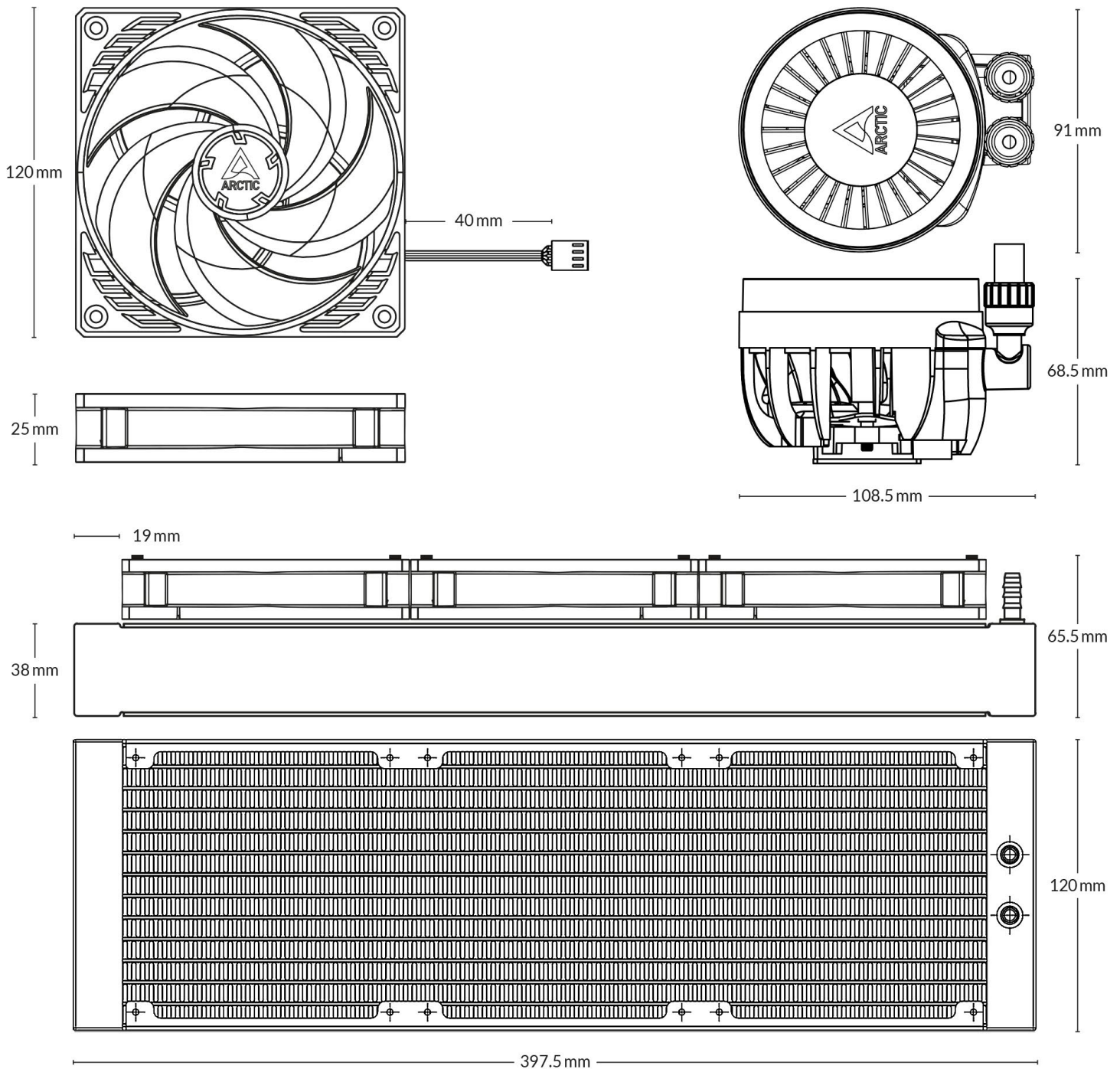

Alle Materialien sind mit den RoHS-Anforderungen kompatibel.

WEITERE INFORMATIONEN



ANLEITUNGEN

