



OWNER'S MANUAL

Wireless Sound Bar

Please read this manual carefully before operating your set and retain it for future reference.

MODEL

SQC1 (SQC1, SPQ1-W)

www.lg.com

Copyright © 2022 LG Electronics Inc. All Rights Reserved.

2207_Rev01

Safety Information



CAUTION: TO REDUCE THE RISK OF ELECTRIC SHOCK DO NOT REMOVE COVER (OR BACK) NO USER-SERVICEABLE PARTS INSIDE REFER SERVICING TO QUALIFIED SERVICE PERSONNEL



This lightning flash with arrowhead symbol within an equilateral triangle is intended to alert the user to the presence of uninsulated dangerous voltage within the product's enclosure that may be of sufficient magnitude to constitute a risk of electric shock to persons.



The exclamation point within an equilateral triangle is intended to alert the user to the presence of important operating and maintenance (servicing) instructions in the literature accompanying the product.

WARNING: TO PREVENT FIRE OR ELECTRIC SHOCK HAZARD, DO NOT EXPOSE THIS PRODUCT TO RAIN OR MOISTURE.

CAUTION: The apparatus should not be exposed to water (dripping or splashing) and no objects filled with liquids, such as vases, should be placed on the apparatus.

WARNING: Do not install this equipment in a confined space such as a book case or similar unit.

CAUTION: Do not use high voltage products around this product. (ex. Electrical swatter) This product may malfunction due to electrical shock.

CAUTION: No naked flame sources, such as lighted candles, should be placed on the apparatus.

CAUTION: Do not block any ventilation openings. Install in accordance with the manufacturer's instructions.

Slots and openings in the cabinet are provided for ventilation and to ensure reliable operation of the product and to protect it from over heating. The openings should never be blocked by placing the product on a bed, sofa, rug or other similar surface. This product shall not be placed in a built-in installation such as a bookcase or rack unless proper ventilation is provided or the manufacturer's instruction has been adhered to.

NOTICE: For safety marking information including product identification and power supply ratings, please refer to the main label on the bottom or the other surface of the product.

CAUTION: Be careful to make sure children do not put their hands or any objects into the *speaker duct.

* speaker duct: A hole for plentiful bass sound on speaker cabinet. (enclosure)

CAUTION concerning the Power Cord

The Power Plug is the disconnecting device. In case of an emergency, the Power Plug must remain readily accessible.

Check the specification page of this owner's manual to be certain of the current requirements.

Do not overload wall outlets. Overloaded wall outlets, loose or damaged wall outlets, extension cords, frayed power cords, or damaged or cracked wire insulation are dangerous. Any of these conditions could result in electric shock or fire. Periodically examine the cord of your device, and if its appearance indicates damage or deterioration, unplug it, discontinue use of the device, and have the cord replaced with an exact replacement part by an authorized service center.

Protect the power cord from physical or mechanical abuse, such as being twisted, kinked, pinched, closed in a door, or walked upon. Pay particular attention to plugs, wall outlets, and the point where the cord exits the device.

CAUTION: Only use the AC adapter supplied with this device. Do not use a power supply from another device or another manufacturer. Using any other power cable or power supply may cause damage to the device and void your warranty.

For models using a battery

This device is equipped with a portable battery or accumulator.

CAUTION: Risk of fire or explosion if the battery is replaced by an incorrect type.

For models using a built-in battery

Do not store or transport at pressures lower than 11.6 kPa and at above 15,000 m altitude.

- replacement of a battery with an incorrect type that can defeat a safeguard (for example, in the case of some lithium battery types);
- disposal of a battery into fire or a hot oven, or mechanically crushing or cutting of a battery, that can result in an explosion;
- leaving a battery in an extremely high temperature surrounding environment that can result in an explosion or the leakage of flammable liquid or gas; and
- a battery subjected to extremely low air pressure that may result in an explosion or the leakage of flammable liquid or gas.

Symbols

~	Refers to alternating current (AC).
≡	Refers to direct current (DC).
⊞	Refers to class II equipment.
⏻	Refers to stand-by.
I	Refers to "ON" (power).
⚡	Refers to dangerous voltage.

Table of Contents

1 Getting Started

- 2 Safety Information
- 6 Unique features
- 6 Introduction
 - Symbols used in this manual
- 7 Remote control
- 8 Front panel
- 8 Rear panel
- 9 About LED condition
- 11 Installing the sound bar

2 Connecting

- 12 Connecting the AC Adapter
- 12 Wireless subwoofer connection
- 14 Connecting to your TV
 - Using an OPTICAL cable
- 14 Optional equipment connection
 - OPT. IN connection
 - PORT. IN connection
 - USB connection
 - Compatible USB devices
 - USB device requirement
 - Playable file

3 Operating

- 18 Basic operations
 - USB operation
- 18 Other operations
 - DRC (Dynamic Range Control)
 - Turn off the sound temporarily
 - Using your TV remote control
 - Auto display Dimmer
 - Auto power down
 - AUTO POWER On/Off
 - Auto function change
- 21 Using BLUETOOTH® technology
 - Listening to music stored on the Bluetooth devices
 - BLUETOOTH connection lock (BT lock)
- 23 Sound adjustment
 - Setting the surround mode
 - Adjust the woofer level settings

4 Troubleshooting

- 24 Troubleshooting
 - General
 - NOTES to use wireless

5 Appendix

- 26 Trademarks and licenses
- 27 Specifications
- 28 Maintenance
 - Handling the unit

1

2

3

4

5

Unique features

Auto power down

This unit supports to turn off by itself for saving energy consumption.

Portable In

Listen to music from your portable device. (MP3 player, Notebook, Smart phone, etc..)

BLUETOOTH®

Listen to music stored on your **Bluetooth** device.

USB playback

Listen to music stored on your USB device.

Introduction

Symbols used in this manual

 **Note**

Indicates special notes and operating features.

 **Caution**

Indicates cautions for preventing possible damages from abuse.

Remote control

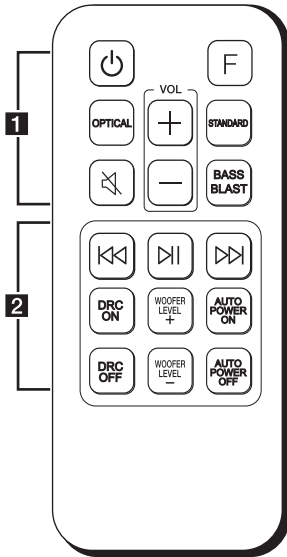

Replacement of battery

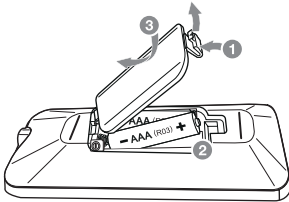

Remove the battery cover on the rear of the remote control, and insert battery with $+$ and $-$ matched correctly.

Risk of fire or explosion if the battery is replaced by an incorrect type.

1

⏻ (Standby): Switches the unit ON or OFF

F (Function): Selects the function.

OPTICAL: Selects the optical function.

🔇 (Mute): Mutes the sound.

STANDARD: Selects standardized sound.

BASS BLAST: Reinforces the bass and powerful sound.

VOL (Volume) $+/-$: Adjusts speaker volume.

2

$\text{⏮} / \text{⏭}$ (Skip/Search):

- Skips Fast backward or Forward.
- Searches for a section within a file.

⏸ (Play/Pause):

- Starts playback.
- Pauses playback.

DRC ON/OFF:

- Turns on or off DRC function. (Page 18)
- Controls this unit using TV remote. (Page 18)

WOOFER LEVEL $+/-$: Adjusts sound level of subwoofer.

AUTO POWER ON/OFF:

- Turns on or off AUTO POWER function. (Page 19)
- Turns on or off the **Bluetooth** connection lock function. (Page 22)

Front panel

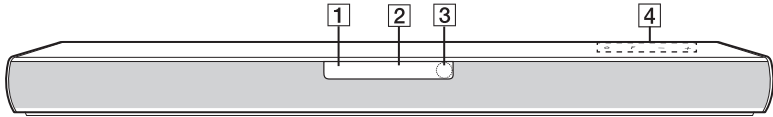





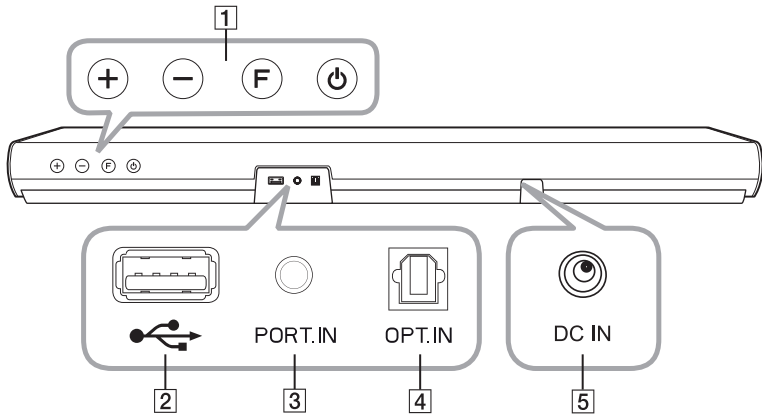

- 1** Standby LED (Red)
- 2** Function LED (White)
- 3** Remote sensor
- 4** The buttons are located on the rear.

Rear panel



- 1** **+ / -** (Volume) : Adjusts volume level
- F** (Function) : Selects the function.
- ⏻** (Standby)
- 2** **↔** (USB) : Connect to a USB device.
- 3** **PORT.IN** (Portable) : Connect to a Portable device.
- 4** **OPT. IN** (Optical) : Connect to an Optical device.
- 5** **DC IN** : Connect to the AC adapter.

About LED condition

LED	Condition	Description
OPTICAL BLUETOOTH PORTABLE USB 	OPTICAL LED turns on.	OPTICAL function is selected.
OPTICAL BLUETOOTH PORTABLE USB 	USB LED turns on.	USB function is selected.
OPTICAL BLUETOOTH PORTABLE USB 	USB LED blinks.	Paused USB playback.
OPTICAL BLUETOOTH PORTABLE USB 	Bluetooth LED turns on.	Paired with Bluetooth device.
OPTICAL BLUETOOTH PORTABLE USB 	Bluetooth LED blinks.	Waiting for Bluetooth connection.
OPTICAL BLUETOOTH PORTABLE USB 	PORTABLE LED turns on.	PORTABLE function is selected.

! Note

- When you press any button, standby LED (Red) on the main unit blinks.
- When you press  (Mute) button, standby LED (Red) blinks slowly.
- When this unit reaches minimum volume, standby LED (Red) turns on for 2 seconds and blinks slowly.
- When this unit reaches maximum volume, standby LED (Red) turns on for 2 seconds.
- When you press volume (+/-) button continually, standby LED (Red) blinks quickly.

Useful functions for using the unit

Function	Description	To do	Do this
TV Remote On/Off (Page 18)	It allows you to control the volume of this unit by your TV remote control even by other company's product. Initial setting of this function was set to on.	ON	Press and hold DRC ON on the remote control for about 2 seconds. The standby LED (Red) blinks once.
		OFF	Press and hold DRC OFF on the remote control for about 2 seconds. The standby LED (Red) blinks once.
BT Lock On/Off (Page 22)	It allows you to connect a Bluetooth device only on Bluetooth functions. Initial setting of this function was set to off.	ON	Press and hold AUTO POWER ON on the remote control for about 2 seconds in Bluetooth function. The standby LED (Red) blinks once.
		OFF	Press and hold AUTO POWER OFF on the remote control for about 2 seconds in Bluetooth function. The standby LED (Red) blinks once.
Auto Power On/Off (Page 19)	It allows the unit to turn on and off automatically by input signals : Optical or Bluetooth . Initial setting of this function was set to on.	ON	Press AUTO POWER ON on the remote control. The standby LED (Red) blinks once.
		OFF	Press AUTO POWER OFF on the remote control. The standby LED (Red) blinks once.

Installing the sound bar

You can hear the sound by connecting the unit to the other device : TV, Blu-ray disc player, DVD player, etc.

Place the unit in front of the TV and connect it to the device you want. (Page 12 - 15)

You can place the wireless subwoofer anywhere in your room. But it is better to place the subwoofer near the main unit. Turn it slightly toward the center of the room to reduce the wall reflections.



! Caution

- For best performance of wireless connection such as **Bluetooth** or wireless subwoofer, do not install the unit on Metallic furniture because wireless connection communicates through a module positioned on the bottom of the unit.
- Be careful not to make scratches on the surface of the Unit / Subwoofer when installing or moving them.

! Note

For the convenient button usage, it is recommended to have some distance between the soundbar and your TV when you install the sound bar.

Connecting the AC Adapter

Connect the unit to the power supply with the supplied AC adapter.

1. Connect the supplied AC power cord to the AC adapter.
2. Connect the AC adapter cable to DC IN adapter input.
3. Plug the AC power cord into an AC outlet.

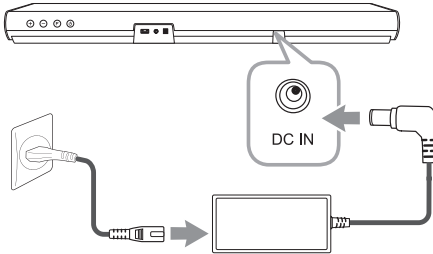

Caution

Only use the AC adapter supplied with this device. Do not use a power supply from another device or manufacturer. Using any other power cable or power supply may cause damage to the device and void your warranty.

Wireless subwoofer connection

LED indicator of wireless subwoofer

LED Color	Status
Green (Blink)	The connection is trying.
Green	The connection is completed.
Red	The wireless subwoofer is in standby mode or the connection failed.
Off (No display)	The power cord of wireless subwoofer is disconnected.

Setting up the wireless subwoofer for the first time

1. Connect the power cord of the sound bar and the wireless subwoofer to the outlet.
2. Turn on the sound bar. The sound bar and the wireless subwoofer will be **automatically** connect.

Manually pairing wireless subwoofer

When your connection is not completed, you can check red LED on the wireless subwoofer and the wireless subwoofer does not make sound. To solve the problem, follow the steps below.

1. Press **Pairing** on the rear of the wireless subwoofer.

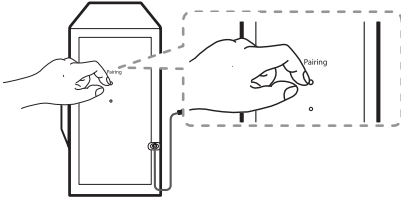

- The green LED on the rear of the wireless subwoofer blinks quickly. (If the green LED does not blink, press and hold the **Pairing**.)
2. Turn on the main unit.
 3. Pairing is completed.
 - The green LED on the rear of the wireless subwoofer turns on.

! Note

- It takes a few seconds (and may take longer) for the main unit and the subwoofer to communicate with each other and make sounds.
- The closer the main unit and the subwoofer, the better sound quality. It is recommended to install the main unit and the subwoofer as close as possible and avoid the cases below.
 - There is an obstacle between the main unit and the wireless subwoofer.
 - There is a device using same frequency with this wireless connection such as a medical equipment, a microwave or a wireless LAN device.
 - Keep the sound bar and the subwoofer away from the device (ex. wireless router, microwave oven, etc.) over 1 m to prevent wireless interference.

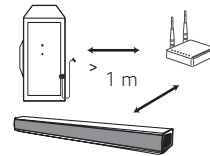

Connecting to your TV

Using an OPTICAL cable

1. Connect the OPT. IN jack on the back of the unit to OPTICAL OUT jack on the TV using an OPTICAL cable.

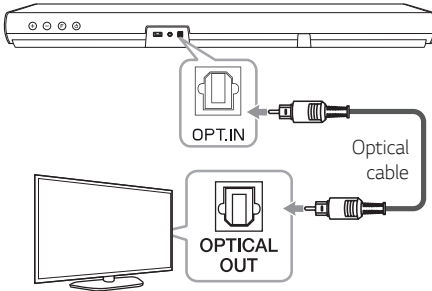

2. Select the input source to Optical by pressing **OPTICAL** on the remote control or **F** repeatedly.

You can see OPTICAL LED turns on. Then optical function is selected.

! Note

- Before connecting the optical cable, be sure to remove the protection plug cover if your cable has the cover.
- You can enjoy the TV audio through the speakers of this unit. In the case of some TV models, you must select the external speaker option from the TV menu. (For details, reference your TV user manual.)
- Set up the sound output of TV to listen to the sound through this unit :
TV setting menu → [Sound] → [TV Sound output] → [External speaker (Optical)]
- Details of TV setting menu vary depending on the manufacturers or models of your TV.

Optional equipment connection

OPT. IN connection

Connect an optical output jack of external devices to the OPT. IN jack.

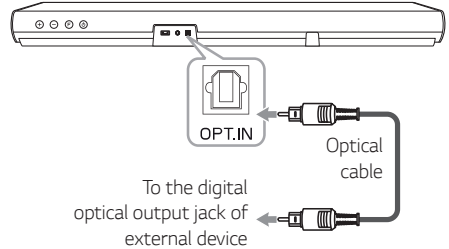

1. Connect the OPT. IN jack on the back of the unit to OPTICAL OUT jack of your external device.
2. Select the input source to Optical by pressing **OPTICAL** on the remote control or **F** repeatedly.

You can see OPTICAL LED turns on. Then optical function is selected.

3. Listen to sound.

! Note

Before connecting the optical cable, be sure to remove the protection plug cover if your cable has the cover.

PORT. IN connection

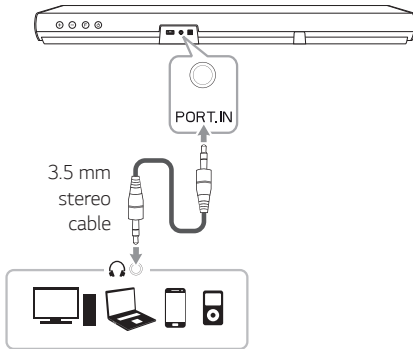

Listening to music from your portable player

The unit can be used to play the music from many types of portable players or external devices.

1. Connect the portable player to the PORT. IN connector of the unit by using 3.5 mm stereo cable.
2. Select the input source to PORTABLE by pressing **F** repeatedly.
You can see PORTABLE LED turns on. Then PORTABLE function is selected.
3. Turn on the portable player or external device and start playing it.

USB connection

Connect USB memory device to the USB port on the back of the unit.

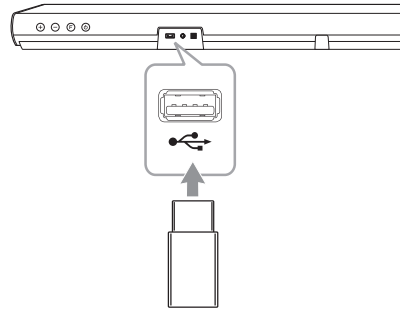

For more information of playing files on a USB, refer to the page 18.

Removing the USB Device from the unit.

1. Choose a different function/mode.
2. Remove the USB device from the unit.

Compatible USB devices

- MP3 Player : Flash type MP3 player.
- USB Flash Drive : Devices that support USB 1.1.
- The USB function of this unit does not support some USB devices.

USB device requirement

- Devices which require additional program installation connected to a computer, are not supported.
- Do not extract the USB device while in operation.
- For a large capacity USB, it may take longer than a few minutes to be searched.
- To prevent data loss, back up all data.
- This unit is not supported when the total number of files is 999 or more.
- The unit's USB Port can not be connected to PC. The unit can not be used as a storage device.
- The exFAT file system is not supported on this unit. (FAT16/FAT32 systems are available.)
- Depending on some devices, it may not available to recognize the followings on this unit.
 - External HDD
 - Card readers
 - Locked devices
 - Hard type USB devices
 - USB hub
 - Using USB extension cable
 - iPhone/iPod/iPad
 - Android device

Playable file

Sampling Frequency

MP3 : within 32 to 48 kHz

WMA : within 32 to 48 kHz

Bitrate

MP3 : within 80 to 320 kbps

WMA : within 56 to 128 kbps

- Maximum files : Under 999
- Maximum directories : Under 99
- A protected file by DRM (Digital rights management) cannot be played on the unit.
- Video files in the USB storage device can not be played.
- Depending on the performance of your USB device, playback may not work well.

! Note

- Folders and files on the USB are recognized as below.

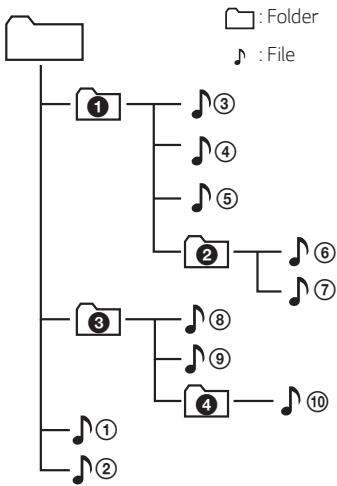

- File will be played from file ① to file ⑩ one by one.
- Files will be played in order recorded and it may be different depending on the record circumstances.
- You can't see a folder or file through this unit.

Basic operations

USB operation

1. Connect the USB device to the USB port.
2. Select the input source to USB by pressing **F** repeatedly.
You can see USB LED turns on. Then USB function is selected.

To	Do this
Playback	Press ▶ on the remote control.
Pause	During playback, press ▶ on the remote control.
Skip to the next/ previous file	During playback, press ▶▶ on the remote control to go to the next file. Playing less than 2 seconds, press ◀◀ on the remote control to go to the previous file. Playing after 3 seconds, press ◀◀ on the remote control to go to the beginning of the file.
Search for a section within a file	Press and hold ◀◀ / ▶▶ on the remote control during playback and release it at the point you want to listen to.
Resume playback	This unit memorizes a current song which is played before changing the function or turning off the unit.

! Note

- The resume point may be cleared when you pull out the power cord or removing the USB device from the unit.
- If the USB function is not working, check the USB function is selected.
- When you pause the USB playback, USB LED on the main unit blinks.

Other operations

DRC (Dynamic Range Control)

Make the sound clear when the volume is turned down and prevent sudden increase of sound (Dolby Digital only). This function turns on or off when you press **DRC ON/OFF**.

Turn off the sound temporarily

Press **⏸** (Mute) to mute your unit.
To cancel it, press **⏸** (Mute) again on the remote control or change the volume level.

Using your TV remote control

You can control some functions of this unit by your TV remote control even by other company's product. Controllable functions are volume up/down and mute.

Press and hold **DRC ON** on the remote control for about 2 seconds. The standby LED blinks once. And then this functions is enabled.

To turn off this function, press and hold **DRC OFF** about 2 seconds. The standby LED blinks once. And then this functions is disabled.

! Note

- Supported TV brands

LG	Panasonic	Philips	Samsung
Sharp	Sony	Toshiba	Vizio

- Make sure that the sound output of your TV is set to [External speaker].
- Depending on the remote control, this function may not work well.
- This function does not operate on LG TV's magic remote control.

Auto display Dimmer

Function LED will be darkened automatically if there is no key input for 15 seconds.

When you press any button, the Function LED will be brighten.

Auto power down

This unit will turn itself off to save electric consumption if the main unit is not connected to an external device and has not been used for 15 minutes.

This unit also turns off after six hours if the Main unit has been connected to another device using the analog input. (Ex : Portable, etc..)

How to deactivate the wireless network connection(s).

Set up the AUTO POWER ON/OFF function to off and turn off the unit.

AUTO POWER On/Off

This unit automatically turns on by an input source : Optical or **Bluetooth**.

When you turn on your TV or an external device connected to this unit, this unit recognizes the input signal and select the suitable function. You can hear the sound from your device.

If you try to connect your **Bluetooth** device, this unit turns on and the unit will be connected your **Bluetooth** device.

This function turns on or off you press **AUTO POWER ON/OFF**.

! Note

- After the unit is turned on by AUTO POWER function, it will be automatically turned off if there is no signal for a certain period of time from the external device.
- If you turned off the unit directly, it cannot be turned on automatically by AUTO POWER function. However the unit can be turned on by AUTO POWER function when optical signal comes in after 5 seconds of no signal.
- Depending on the connected device, this function may not operate.
- If you disconnect **Bluetooth** connection by this unit, some **Bluetooth** devices try to connect to the unit continually. Therefore it is recommended to disconnect the connection before turn off the unit.
- When you turn on this unit for the first time, Auto Power function is turned on status.
- To use this function, the main unit must be registered in paired devices list of **Bluetooth** device.
- You can set the AUTO POWER function only when this unit is turned on.

Auto function change

This unit recognizes input signals such as Optical, **Bluetooth** and Portable and then changes suitable function automatically.

When optical signal comes in

When you turn on the external device connected to this unit by an optical cable, this unit change the function to optical. You can hear the sound from your device.

When you try to connect Bluetooth device

When you try to connect your **Bluetooth** device to this unit, **Bluetooth** function is selected. Play your music on the **Bluetooth** device.

When 3.5 mm stereo cable is connected

When you connect your portable device using a 3.5 mm stereo cable, this unit changes the function to Portable. You can hear the music from your device.

Note

- To change to optical function, it needs 5 seconds of no signal.
- If the **Bluetooth** connection lock function is set, **Bluetooth** connection will be only available on **Bluetooth** function. (Page 22)

Using BLUETOOTH® technology

About Bluetooth

Bluetooth is wireless communication technology for short range connection.

The sound may be interrupted when the connection interfered by the other electronic wave or you connect the **Bluetooth** in the other rooms.

Connecting individual devices under **Bluetooth** wireless technology does not incur any charges.

A mobile phone with **Bluetooth** wireless technology can be operated via the Cascade if the connection was made via **Bluetooth** wireless technology.

- Available Devices : Smart phone, MP3, Notebook, etc..
- Version : 4.0
- Codec : SBC

Bluetooth Profiles

In order to use **Bluetooth** wireless technology, devices must be able to interpret certain profiles. This unit is compatible with following profile.

A2DP (Advanced Audio Distribution Profile)

Listening to music stored on the Bluetooth devices

Pairing your unit and Bluetooth device

Before you start the pairing procedure, make sure that the **Bluetooth** feature on your smart device is turned on. Refer to your **Bluetooth** device's user guide. Once a pairing operation is performed, it does not need to be performed again.

1. Select the input source to **Bluetooth** by pressing **F** repeatedly.
 - **Bluetooth** LED will blink.
2. Operate the **Bluetooth** device and perform the pairing operation. When searching for this unit with the **Bluetooth** device, a list of the devices found may appear in the **Bluetooth** device display depending on the type of **Bluetooth** device. Your unit appears as "LG SQC1 (XX)".

Note

- XX means the last two digits of **Bluetooth** address. For example, if your unit has a **Bluetooth** address such as 9C:02:98:4A:F7:08, you will see "LG SQC1 (08)" on your **Bluetooth** device.
- Depending on the **Bluetooth** device type, some device have a different pairing way. Enter the PIN code (0000) as needed.

3. When this unit is successfully connected with your **Bluetooth** device, **Bluetooth** LED will turn on.
4. Listen to music.
To play a music stored on your **Bluetooth** device, refer to your **Bluetooth** device's user guide.

! Note

- When using **Bluetooth** technology, you have to make a connection between the unit and the **Bluetooth** device as close as possible and keep the distance. However it may not work well in the cases below :
 - There is an obstacle between the unit and the **Bluetooth** device.
 - There is a device using same frequency with **Bluetooth** technology such as a medical equipment, a microwave or a wireless LAN device.
- If **Bluetooth** connection does not work well, try pairing it again.
- The sound may be interrupted when the connection has interference by the other electronic waves.
- Pairing is limited one **Bluetooth** device per one unit and multi-pairing is not supported.
- Depending on the type of the device, you may not be able to use the **Bluetooth** function.
- You can enjoy **Bluetooth** function using Smart phone, MP3, Notebook, etc..
- The more distance between the unit and the **Bluetooth** device, the lower the sound quality becomes.
- **Bluetooth** connection will be disconnected when the unit is turned off or the **Bluetooth** device gets far from the unit.
- When **Bluetooth** connection is disconnected, connect the **Bluetooth** device to the unit again.

! Note

- When the unit is not connected with **Bluetooth** device, **Bluetooth** LED will blink.
- When you connect **Bluetooth** device (iOS device etc.) to this unit or operate the device, the volume level can be synchronized with each other.
- You can control a **Bluetooth** device using **⏮ / ⏭** (Skip) and **⏸** (Play/Pause) buttons on the remote control.
- If you change to another function after connecting **Bluetooth**, **Bluetooth** connection will be disconnected. And you return to **Bluetooth** function, **Bluetooth** connection will be connected automatically.

BLUETOOTH connection lock (BT lock)

You can limit **Bluetooth** connection to only **Bluetooth** function to prevent unintended **Bluetooth** connection.

Press and hold **AUTO POWER ON** on the remote control for about 2 seconds to turn on this function in **Bluetooth** function. The standby LED blinks once. And then this functions is enabled.

To turn off this function, press and hold **AUTO POWER OFF** on the remote control for about 2 seconds in **Bluetooth** function. The standby LED blinks once. And then this functions is disabled.

! Note

Even if you set up **Bluetooth** connection lock to On, this sound bar turns on by Auto Power function. Turn off Auto Power function to prevent it. (Page 19)

Sound adjustment

Setting the surround mode

This system has two pre-set surround sound fields. You can select a desired sound mode by using each sound mode button.

Sound effect	Description
STANDARD	You can enjoy optimized sound.
BASS BLAST	Reinforces the bass and powerful sound.

! Note

- In some of sound effect mode, some speakers, there's no sound or low sound. It depends on the mode of sound and the source of audio, it is not defective.
- You may need to reset the sound effect mode, after switching the input, sometimes even after the sound file changed.

Adjust the woofer level settings

You can adjust the sound level of subwoofer as your preference.

Press **WOOFER LEVEL** \pm on the remote control to adjust woofer level.

! Note

When the subwoofer level reaches maximum or minimum, standby LED (Red) on the main unit turns on for 2 seconds.

Troubleshooting

General

PROBLEM	CAUSE & CORRECTION
The unit does not work properly.	<ul style="list-style-type: none"> • Turn off the power of this unit and the connected external device (TV, Woofer, DVD-player, Amplifier, etc.) and turn them on again. • Disconnect the power cord of this unit and the connected external device (TV, Woofer, DVD-player, Amplifier, etc.) and then try connecting again. • Previous setting may not be saved when device power is shut off.
No Power	<ul style="list-style-type: none"> • The power cord is unplugged. Plug in the power cord. • Check whether electricity failed. Check the condition by operating other electronic devices.
No sound	<ul style="list-style-type: none"> • Incorrect input source is selected. Check the input source and select the correct input source. • The mute function is activated. Press  (Mute) or adjust the volume level to cancel the mute function. • When you are using connection with an external device (set top box, Bluetooth device etc.), adjust volume level of the device.
No woofer sound	<ul style="list-style-type: none"> • The power cord of woofer is not connected. Plug the power cord into the wall outlet securely. • Pairing between the unit and woofer gets disconnected. Connect the unit and woofer. (Page 12)
The remote control does not work properly.	<ul style="list-style-type: none"> • The remote control is too far from the unit. Operate the remote control within about 7 m. • There is an obstacle in the path of the remote control and the unit. Remove the obstacle. • The batteries in the remote control is exhausted. Replace the batteries with new one.
The AUTO POWER function does not work.	<ul style="list-style-type: none"> • Check connection of the external device such as TV, DVD/Blu-Ray player or Bluetooth device. • Depending on the connected device, this function may not operate.
The unit does not connect with Bluetooth device	<ul style="list-style-type: none"> • Turn off the Bluetooth connection lock function. (Page 22)

PROBLEM	CAUSE & CORRECTION
<p>When you feel the output sound of the unit is low.</p>	<p>Check the details below and adjust the unit according to them.</p> <ul style="list-style-type: none"> • Switch [ON] state of DRC function to [OFF] by using remote controller. • With the sound bar connected with TV, change the AUDIO DIGITAL OUT setting on TV Setup Menu from [PCM] to [AUTO] or [BITSTREAM]. • With the sound bar connected with Player, change the AUDIO DIGITAL OUT setting on Player Setup Menu from [PCM] to [PRIMARY PASS-THROUGH] or [BITSTREAM].
<p>USB is not recognized.</p>	<ul style="list-style-type: none"> • Format the USB device and connect it again. When formatting the USB device, select the available file system. (Page 16)

NOTES to use wireless

PROBLEM	CAUSE & CORRECTION
<p>This device may have wireless interference.</p>	<ul style="list-style-type: none"> • Wireless may not operate normally in weak signal area. • Please install the device close enough to wireless subwoofer. • Do not install the device on metal furniture for optimum performance.
<p>Bluetooth device may malfunction or make noise in the following cases.</p>	<ul style="list-style-type: none"> • When any part of your body contact the transceiver of the Bluetooth device or sound bar. • When there is an obstacle or wall or the device is installed in a secluded spot. • When there is a device(a wireless LAN, a medical equipment or a microwave) using same frequency, make the distance between the products as far away as possible each other. • When to connecting the device to the Bluetooth device, make the distance between the products as close as possible each other. • When the device gets too far from the Bluetooth device, the connection is disconnected and also malfunction may occur.

Trademarks and licenses

All other trademarks are trademarks of their respective owners.



Manufactured under license from Dolby Laboratories. Dolby, Dolby Audio, and the double-D symbol are trademarks of Dolby Laboratories Licensing Corporation.



The **Bluetooth**® word mark and logos are registered trademarks owned by the **Bluetooth** SIG, Inc. and any use of such marks by LG Electronics is under license. Other trademarks and trade names are those of their respective owners.

Specifications

General	
Power consumption	Refer to the main label.
	Networked standby : 0.5 W
AC adapter	<ul style="list-style-type: none"> • Model : A931-230087W-M21 • Manufacturer : Dongguan Aohai Technology Co.,Ltd. • Input : 100 - 240 V ~ 50/60 Hz • Output : 23.0 V $\overline{\text{---}}$ 0.87 A
Dimensions (W x H x D)	Approx. 660.0 mm x 56.0 mm x 99.0 mm (including the base)
Operating temperature	5 °C to 35 °C
Operating humidity	5 % to 90 %
Bus Power Supply	5 V $\overline{\text{---}}$ 500 mA
Available Digital Input Audio Sampling Frequency	32 kHz, 44.1 kHz, 48 kHz, 88.2 kHz, 96 kHz
Available Digital Input Audio format	Dolby Audio, PCM

Inputs	
OPT. IN (Digital audio in)	0 dBfs, Optical jack x 1
PORT. IN (Portable in)	0.4 Vrms (3.5 mm stereo jack) x 1

Amplifier (RMS Output power)	
Total	160 W RMS
Front	30 W RMS x 2 (8 Ω at 1 kHz, 10% THD)
Subwoofer	100 W RMS (3 Ω at 100 Hz, 10% THD)

Wireless subwoofer	
Power requirements	Refer to the main label on the subwoofer.
Power consumption	Refer to the main label on the subwoofer.
Type	1 Way 1 Speaker
Impedance	3 Ω
Rated Input Power	100 W RMS
Max. Input Power	200 W RMS
Dimensions (W x H x D)	Approx. 185.5 mm x 303.0 mm x 205.0 mm

- Designs and specifications are subject to change without prior notice.

Maintenance

Handling the unit

When shipping the unit

Please save the original shipping carton and packing materials. If you need to ship the unit, for maximum protection, re-pack the unit as it was originally packed at the factory.

Keeping the exterior surfaces clean

- Do not use volatile liquids such as insecticide spray near the unit.
- Wiping with strong pressure may damage the surface.
- Do not leave rubber or plastic products in contact with the unit for a long period of time.

Cleaning the unit

To clean the player, use a soft, dry cloth. If the surfaces are extremely dirty, use a soft cloth lightly moistened with a mild detergent solution. Do not use strong solvents such as alcohol, benzene, or thinner, as these might damage the surface of the unit.

