

E13863



ROG SWIFT OLED

PG42UQ

USER GUIDE

ASUS

First Edition
March 2022

Copyright © 2022 ASUSTeK COMPUTER INC. All Rights Reserved.

No part of this manual, including the products and software described in it, may be reproduced, transmitted, transcribed, stored in a retrieval system, or translated into any language in any form or by any means, except documentation kept by the purchaser for backup purposes, without the express written permission of ASUSTeK COMPUTER INC. ("ASUS").

Product warranty or service will not be extended if: (1) the product is repaired, modified or altered, unless such repair, modification or alteration is authorized in writing by ASUS; or (2) the serial number of the product is defaced or missing.

ASUS PROVIDES THIS MANUAL "AS IS" WITHOUT WARRANTY OF ANY KIND, EITHER EXPRESS OR IMPLIED, INCLUDING BUT NOT LIMITED TO THE IMPLIED WARRANTIES OR CONDITIONS OF MERCHANTABILITY OR FITNESS FOR A PARTICULAR PURPOSE. IN NO EVENT SHALL ASUS, ITS DIRECTORS, OFFICERS, EMPLOYEES OR AGENTS BE LIABLE FOR ANY INDIRECT, SPECIAL, INCIDENTAL, OR CONSEQUENTIAL DAMAGES (INCLUDING DAMAGES FOR LOSS OF PROFITS, LOSS OF BUSINESS, LOSS OF USE OR DATA, INTERRUPTION OF BUSINESS AND THE LIKE), EVEN IF ASUS HAS BEEN ADVISED OF THE POSSIBILITY OF SUCH DAMAGES ARISING FROM ANY DEFECT OR ERROR IN THIS MANUAL OR PRODUCT.

SPECIFICATIONS AND INFORMATION CONTAINED IN THIS MANUAL ARE FURNISHED FOR INFORMATIONAL USE ONLY, AND ARE SUBJECT TO CHANGE AT ANY TIME WITHOUT NOTICE, AND SHOULD NOT BE CONSTRUED AS A COMMITMENT BY ASUS. ASUS ASSUMES NO RESPONSIBILITY OR LIABILITY FOR ANY ERRORS OR INACCURACIES THAT MAY APPEAR IN THIS MANUAL, INCLUDING THE PRODUCTS AND SOFTWARE DESCRIBED IN IT.

Products and corporate names appearing in this manual may or may not be registered trademarks or copyrights of their respective companies, and are used only for identification or explanation and to the owners' benefit, without intent to infringe.

Contents

Notices.....	iv
Safety information	v
Care & Cleaning	1-1
1.1 Welcome	1-3
1.2 Package contents.....	1-3
1.3 Attaching the Stand	1-4
1.3.1 Cable Management.....	1-4
1.3.2 Remote Control.....	1-5
1.4 Connect cables	2-1
1.4.1 Rear of the LCD monitor	2-1
1.5 Monitor introduction	2-2
1.5.1 Front/Side view	2-2
2.1 Adjusting the monitor.....	2-3
2.2 Outline dimension.....	2-4
2.3 Turning on the monitor.....	2-5
3.1 OSD (On-Screen Display) menu	2-6
3.1.1 How to reconfigure.....	2-6
3.1.2 OSD Function Introduction.....	3-1
5. PIP/PBP Setup	3-5
6. MyFavorite	3-5
3.3 Specifications.....	3-10
3.3 Troubleshooting (FAQ).....	3-12
3.4 Supported Timing List.....	3-13

Notices

Federal Communications Commission Statement

This device complies with Part 15 of the FCC Rules. Operation is subject to the following two conditions:

- This device may not cause harmful interference.
- This device must accept any interference received including interference that may cause undesired operation.

This equipment has been tested and found to comply with the limits for a Class B digital device, pursuant to Part 15 of the FCC Rules. These limits are designed to provide reasonable protection against harmful interference in a residential installation. This equipment generates, uses and can radiate radio frequency energy and, if not installed and used in accordance with the instructions, may cause harmful interference to radio communications. However, there is no guarantee that interference will not occur in a particular installation. If this equipment does cause harmful interference to radio or television reception, which can be determined by turning the equipment off and on, the user is encouraged to try to correct the interference by one or more of the following measures:

- Reorient or relocate the receiving antenna.
- Increase the separation between the equipment and receiver.
- Connect the equipment to an outlet on a circuit different from that to which the receiver is connected.
- Consult the dealer or an experienced radio/TV technician for help.



The use of shielded cables for connection of the monitor to the graphics card is required to assure compliance with FCC regulations. Changes or modifications to this unit not expressly approved by the party responsible for compliance could void the user's authority to operate this equipment.

Declaration of Conformity This device complies with the requirements set out in the Council Directive on the Approximation of the Laws of the Member States relating to Electromagnetic Compatibility (2014/30/EU), Low-voltage Directive (2014/35/EU), ErP Directive (2009/125/EC) and RoHS directive (2011/65/EU). This product has been tested and found to comply with the harmonized standards for Information Technology Equipment, these harmonized standards published under Directives of Official Journal of the European Union.

Canadian Department of Communications Statement

This digital apparatus does not exceed the Class B limits for radio noise emissions from digital apparatus set out in the Radio Interference Regulations of the Canadian Department of Communications.

This class B digital apparatus complies with Canadian ICES-003.

This Class B digital apparatus meets all requirements of the Canadian Interference-Causing Equipment Regulations.

Cet appareil numérique de la classe B respecte toutes les exigences du Règlement sur le matériel brouiller du Canada.

This marking or statement shall include the following or similar text:

CAUTION

RISK OF EXPLOSION IF BATTERY IS REPLACED BY AN INCORRECT TYPE.

DISPOSE OF USED BATTERIES ACCORDING TO THE INSTRUCTIONS

Caution

Replacement of a battery with an incorrect type that can be defeat a safeguard

Disposal of a battery into fire or a hot oven, or mechanically crushing or cutting of a battery, that can result in an explosion

Leaving a battery in an extremely high temperature surrounding environment that can result in an explosion or the leakage of flammable liquid or gas

A battery subjected to extremely low air pressure that may result in an explosion or the leakage of flammable liquid or gas.

Safety information

- Before setting up the monitor, carefully read all the documentation that came with the package.
- To prevent fire or shock hazard, never expose the monitor to rain or moisture.
- Never try to open the monitor cabinet. The dangerous high voltages inside the monitor may result in serious physical injury.
- If the power supply is broken, do not try to fix it by yourself. Contact a qualified service technician or your retailer.
- Before using the product, make sure all cables are correctly connected and the power cables are not damaged. If you detect any damage, contact your dealer immediately.

- Slots and openings on the back or top of the cabinet are provided for ventilation. Do not block these slots. Never place this product near or over a radiator or heat source unless proper ventilation is provided.
- The monitor should be operated only from the type of power source indicated on the label. If you are not sure of the type of power supply to your home, consult your dealer or local power company.
- Use the appropriate power plug which complies with your local power standard.
- Do not overload power strips and extension cords. Overloading can result in fire or electric shock.
- Avoid dust, humidity, and temperature extremes. Do not place the monitor in any area where it may become wet. Place the monitor on a stable surface.
- Unplug the unit during a lightning storm or if it will not be used for a long period of time. This will protect the monitor from damage due to power surges.
- Never push objects or spill liquid of any kind into the slots on the monitor cabinet.
- To ensure satisfactory operation, use the monitor only with UL listed computers which have appropriate configured receptacles marked between 100 ~ 240V AC.
- The socket-outlet shall be installed near the equipment and shall be easily accessible
- If you encounter technical problems with the monitor, contact a qualified servicer.
- Provide an earthing connection before the mains plug is connected to the mains. And, when disconnecting the earthing connection, be sure to disconnect after pulling out the mains plug from the mains.
- Please confirm the distribution system in building installation shall provide the circuit breaker rated 120/240V, 20A (maximum).
- If provided with a 3-pin attachment plug on the power cord, plug the cord into a grounded (earthed) 3-pin outlet. Do not disable the power cord grounding pin, for example, by attaching a 2-pin adapter. The grounding pin is an important safety feature.

WARNING

Usage of other than specified head- or earphones can result in hearing loss due to excessive sound pressures.

Stability Hazard.

The product may fall, causing serious personal injury or death. To prevent injury, this product must be securely attached to the floor/wall in accordance with the installation instructions.

A product may fall, causing serious personal injury or death. Many injuries, particularly to children, can be avoided by taking simple precautions such as:

ALWAYS use cabinets or stands or installation methods recommended by the manufacturer of the product set.

ALWAYS use furniture that can safely support the product.

ALWAYS ensure the product is not overhanging the edge of the supporting furniture.

ALWAYS educate children about the dangers of climbing on furniture to reach the product or its controls.

ALWAYS route cords and cables connected to your product so they cannot be tripped over, pulled or grabbed.

NEVER place a product in an unstable location.

NEVER place the product on tall furniture (for example, cupboards or bookcases) without anchoring both the furniture and the product to a suitable support.

NEVER place the product on cloth or other materials that may be located between the product and supporting furniture.

NEVER place items that might tempt children to climb, such as toys and remote controls, on the top of the product or furniture on which the product is placed.

If the existing product is going to be retained and relocated, the same considerations as above should be applied.

Restriction on Hazardous Substances statement (India)

This product complies with the "India E-Waste (Management) Rules, 2016" and prohibits use of Lead, Mercury, Hexavalent Chromium, polybrominated biphenyls(PBBs) and polybrominated diphenyl ethers(PBDEs) in concentration exceeding 0.1% by weight in homogenous materials and 0.01% by weight in homogenous materials for cadmium, except of exemptions listed in Schedule 2 of the Rule.



EAC



Disposal of waste equipment by user in private household in the European Union

This symbol on the product or on its packaging indicates that this product must not be disposed of with your other household waste. Instead, it is your responsibility to dispose of your waste equipment by handing it over to a designated collection point for the recycling of waste electrical and electronic equipment. The separate collection and recycling of your waste equipment at the time of disposal will help to conserve natural resources and ensure that it is recycled in a manner that protects human health and the environment. For more information about where you can drop off your waste equipment for recycling, please contact your local city office, your household waste disposal service or the shop where you purchased the product.

The Monitor uses low blue light panel and compliance with TÜV Rheinland Low Blue Light Hardware Solution at factory reset/default setting mode.

TÜV Rheinland Flicker Free Certification.

This product to ascertain whether the display produces visible and invisible flicker for the human eye and therefore strains the eyes of users.

Prevent Tipping

When using the display, fasten the LCD to a wall using a cord or chain that can support the weight of the monitor in order to prevent the monitor from falling.

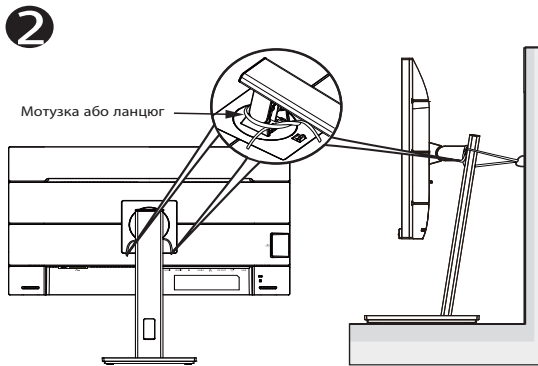
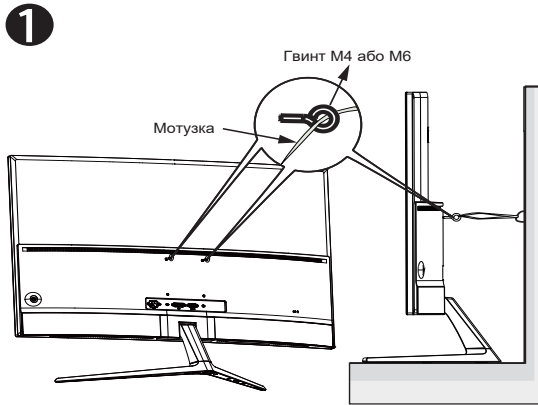

- Display design may differ from those illustrated.
- Installing must be done by a qualified technician, and please contact your supplier for more information.
- For the Models with net weight $\geq 7\text{kg}$. Please select the suitable way to Prevent Tipping.
- For the models with VESA Mount, please use method **1**, install the screws with ring to the VESA Mount hole, then tie the cord or chain to the wall. Otherwise, please use method **2** to tie the cord or chain to the stand and then fix it to the wall.

Care & Cleaning

- Before you lift or reposition your monitor, it is better to disconnect the cables and power cord. Follow the correct lifting techniques when positioning the monitor. When lifting or carrying the monitor, grasp the edges of the monitor. Do not lift the display by the stand or the cord.
- Cleaning. Turn your monitor off and unplug the power cord. Clean the monitor surface with a lint-free, non-abrasive cloth. Stubborn stains may be removed with a cloth dampened with mild cleaner.
- Avoid using a cleaner containing alcohol or acetone. Use a cleaner intended for use with the LCD. Never spray cleaner directly on the screen, as it may drip inside the monitor and cause an electric shock.



This symbol of the crossed out wheeled bin indicates that the product (electrical, electronic equipment, and mercury-containing button cell battery) should not be placed in municipal waste. Please check local regulations for disposal of electronic products.

AEEE yönetmeliğine uygundur

The following symptoms are normal with the monitor:

- The screen may flicker during the initial use due to the nature of the fluorescent light. Turn off the Power Switch and turn it on again to make sure that the flicker disappears.
- You may find slightly uneven brightness on the screen depending on the desktop pattern you use.
- When the same image is displayed for hours, an afterimage of the previous screen may remain after switching the image. The screen will recover slowly or you can turn off the Power Switch for hours.
- When the screen becomes black or flashes, or cannot work anymore, contact your dealer or service center to fix it. Do not repair the screen by yourself!

Conventions used in this guide



WARNING: Information to prevent injury to yourself when trying to complete a task.



CAUTION: Information to prevent damage to the components when trying to complete a task.



IMPORTANT: Information that you **MUST** follow to complete a task.



NOTE: Tips and additional information to aid in completing a task.

Where to find more information

Refer to the following sources for additional information and for product and software updates.

1. **ASUS websites**

The ASUS websites worldwide provide updated information on ASUS hardware and software products. Refer to **<http://www.asus.com>**

2. **Optional documentation**

Your product package may include optional documentation that may have been added by your dealer. These documents are not part of the standard package.

Takeback Services

ASUS recycling and takeback programs come from our commitment to the highest standards for protecting our environment. We believe in providing solutions for our customers to be able to responsibly recycle our products, batteries and other components as well as the packaging materials.

Please go to <http://csr.asus.com/english/Takeback.htm> for detail recycling information in different region.

Product information for EU energy label



1.1 Welcome

Thank you for purchasing the ASUS® OLED Gaming monitor!

The latest widescreen OLED monitor from ASUS provides a crisper, broader, and brighter display, plus a host of features that enhance your viewing experience.

With these features, you can enjoy the convenience and delightful visual experience that the monitor brings to you!

1.2 Package contents

Check your package for the following items:

- ✓ OLED Monitor
- ✓ Monitor Base
- ✓ Quick Start Guide
- ✓ Warranty Card
- ✓ Power Cord
- ✓ Ultra High Speed HDMI 2.1 Cable
- ✓ DP Cable
- ✓ USB Cable
- ✓ Input/Output port cover
- ✓ Color Calibration Testing Report
- ✓ Remote Control
- ✓ Battery
- ✓ ROG sticker



-
- If any of the above items is damaged or missing, contact your retailer immediately.
-



-
- If no signal is detected for around 10 minutes, the monitor automatically enters saving mode.
-

1.3 Attaching the Stand

1. Remove the input/output port cover from the rear of the monitor. Then remove the Allen wrench from the cover.
2. Replace the input/output port cover. Then align and install the stand onto its slot.
3. Using the Allen wrench, secure the stand with the four (4) screws.

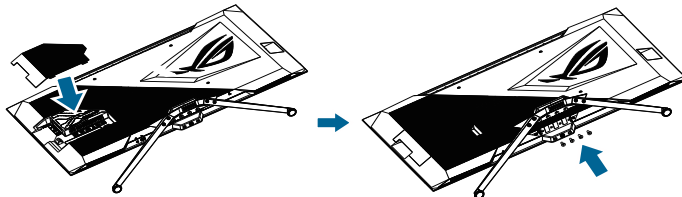

- We recommend that you cover the table surface with soft cloth to prevent damage to the monitor

1.3.1 Cable Management

You can organize the cables with the help of the input/output port cover.

- **Arranging the cables**

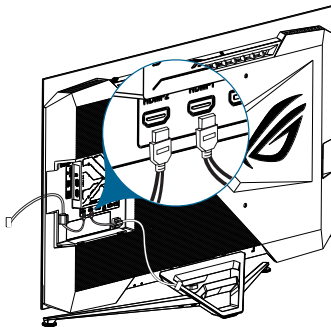

- **Using the input/output port cover:** the cover can be attached or detached.

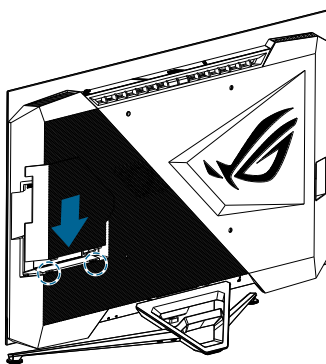

1.3.2 Remote Control

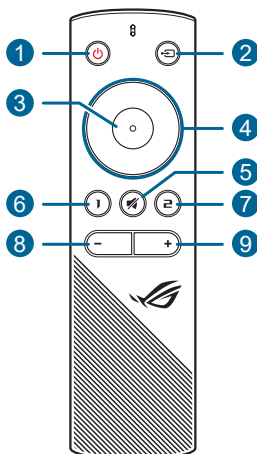

1. **Power button:** Turn the monitor on/off.
2. **Input button:** Switch the input source.
3. **Enter button:** Confirm the selection.
4. **Navigation buttons:** Increase/Decrease values or moves your selection up/down/left/right.
5. **Mute button:** Turn off the sound temporarily.
6. **Shortcut 1 button:** By default, it is GamePlus hotkey. To change the hotkey function, go to the MyFavorite > Shortcut > Shortcut1 menu.
7. **Shortcut 2 button:** By default, it is GameVisual hotkey. To

change the hotkey function, go to the MyFavorite > Shortcut > Shortcut2 menu.

8. **— Volume Down button:** Decrease the volume level.

9. **+ Volume Up button:** Increase the volume level.

For battery replacement:

Open the battery cover and install the batteries into the battery compartment.

Then replace the battery cover.

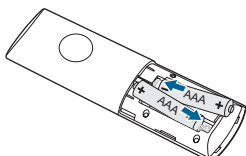

1.4 Connect cables

1.4.1 Rear of the LCD monitor

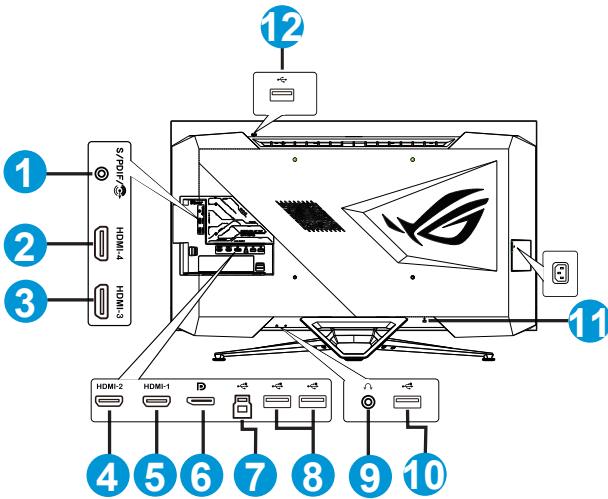

1. S/PDIF
2. HDMI2.0 Port
3. HDMI2.0 Port
4. HDMI2.1 Port
5. HDMI2.1 Port
6. DisplayPort
7. USB type B Port
8. USB3.0 Downstream Port
9. Earphone Jack
10. USB3.0 Downstream Port
11. Kensington Lock
12. USB3.0 Upstream Port

1.5 Monitor introduction

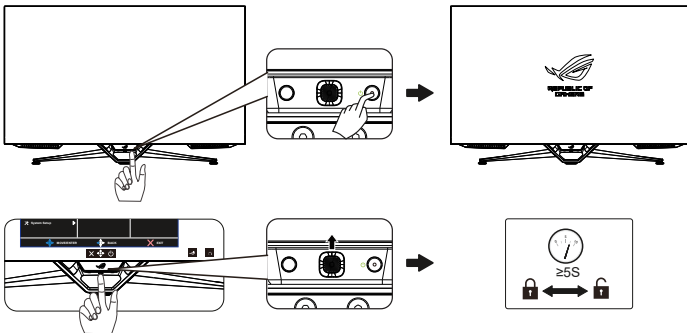

1.5.1 Front/Side view

Use the control button on the bottom of the monitor to adjust the monitor settings.



1. Power Indicator:
The color definition of the power indicator is as the below table.

Status	Description
Status	Description
Red	ON (Power Setting is Standard mode.)
Amber	Standby mode (Power Setting is Standard Mode.)
OFF	OFF Standby mode (Power Setting is Power Saving Mode.)

2.  Power Button:
 - Press this button to turn the monitor off. Press any key to turn on the monitor.
3.  (5-way) Button:
 - Press this button to turn on the OSD menu.
 - Increases/Decreases values or moves your selection up/down/left/right
4.  Close Button:
 - Exit the OSD menu.

2.1 Adjusting the monitor

- For optimal viewing, we recommend that you look at the full face of the monitor, then adjust the monitor to the angle that is most comfortable for you.
- Hold the stand to prevent the monitor from falling when you change its angle.
- You can adjust the monitor's angle from -5° to 5° .

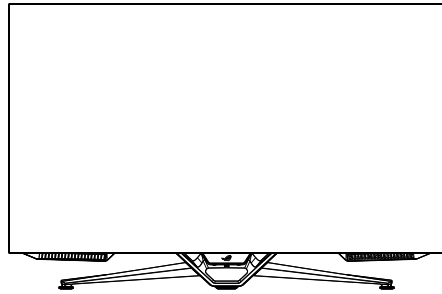
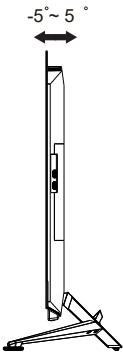

It is normal that the monitor slightly shakes while you adjust the viewing angle.

2.2 Outline dimension

Unit: mm [inch]

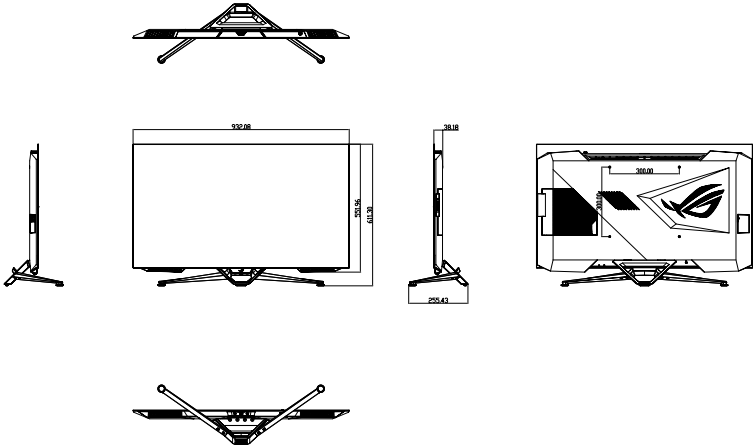

2.3 Turning on the monitor

Press the power button. See page 1-3 for the location of the power button. The power indicator lights up in white to show that the monitor is ON.

3.1 OSD (On-Screen Display) menu

3.1.1 How to reconfigure

You can either use the remote control or the Control buttons on the monitor to navigate through the menu and make adjustments.

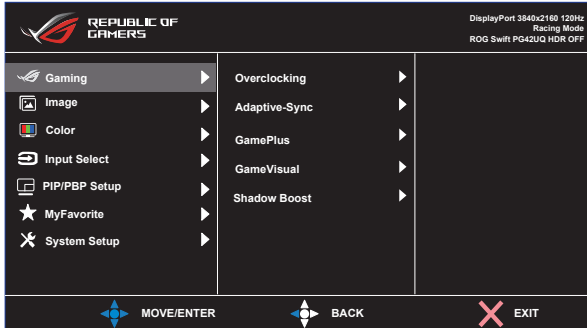

To navigate through the menu and make adjustments using the remote control, do the following:

1. Press the Enter button to activate the OSD menu.
2. Move the Navigation button up/down to navigate through the functions. Highlight the desired function and press the Enter button to activate it. If the function selected has a sub-menu, move the Navigation button up/down again to navigate through the sub-menu functions. Highlight the desired sub-menu function and press the Enter button or move the Navigation button right to activate it.
3. Move the Navigation button up/down to change the settings of the selected function.
4. To exit and save the OSD menu, move the Navigation button left repeatedly until the OSD menu disappears. To adjust other functions, repeat steps 1 to 3.

3.1.2 OSD Function Introduction

1. Gaming

Configure your gaming preferences.

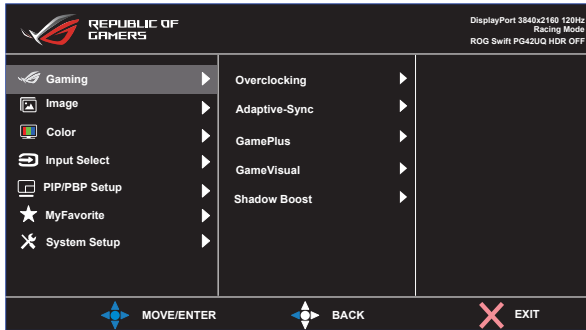

- **Overclocking:** Adjust the refresh rate.
 - **ON:** This function allows you to adjust the refresh rate.
 - **Max Refresh Rate:** Allow you to select a maximum refresh rate of 138Hz (Only for DisplayPort / HDMI1 / HDMI2 input).



- Overclocking may cause screen flickering. To reduce such effects, disconnect the DisplayPort cable and use the monitor OSD menu to try again with a safer Max. Refresh rate.

- **Variable Refresh Rate:** Allow an Adaptive-Sync supported graphics source to dynamically adjust display refresh rate based on typical content frame rates for power efficient, virtually stutter free and low-latency display update.





- This function can only be activated within 48Hz~120Hz for HDMI1/HDMI2 and 48Hz~120Hz for DisplayPort.
- For supported GPUs, minimum PC system and driver requirements, please contact the GPU manufactures.

- **GamePlus:** Configure the gaming environment. See 1.3.4 GamePlus Function for details.
- **GameVisual:** Select the picture mode. See 1.3.5 GameVisual Function for details.
- **Shadow Boost:** Adjust the monitor gamma curve to enrich the dark tones in an image, making dark scenes and objects much easier to be seen.

2. Image

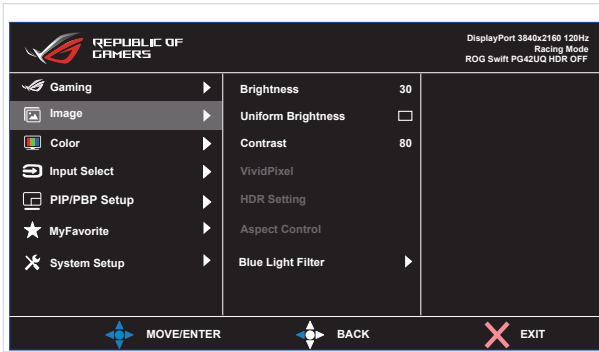
Configure the image settings.



- **Brightness:** Adjust the brightness level.
 - **Uniform Brightness:** With the feature enabled, the system will not adjust the maximum brightness of the screen when the screen is displayed in a different screen size.
 - **Contrast:** Adjust the contrast level.
 - **VividPixel:** Enhance the outline of the displayed picture and generates high-quality images on screen.
 - **HDR Setting:** Set the HDR mode to ASUS Gaming HDR, ASUS Cinema HDR, or Console HDR. The HDR brightness can be adjusted when the Brightness Adjustable function is enabled.
 - **Aspect Control:** Adjusts the aspect ratio to **Full, Equivalent, 1:1, 16:9 (24" W), 16:9 (27" W), and 21:9 (34" W)**.
 - **Blue Light Filter:** Reduce the energy level of blue light emitted from the LED backlight.
 - **Level 0:** No change.
 - **Level 1~4:** The higher the level, the less blue light is scattered. When Blue Light Filter is activated, the default settings of Racing Mode will be automatically imported. Between Level 1 to Level 3, the Brightness function is user-configurable. Level 4 is optimized setting. The Brightness function is not user-configurable.
-
- 
- The Monitor uses low blue light panel and compliance with TÜV Rheinland Low Blue Light Hardware Solution at factory reset/default setting mode (Brightness: 90%, Contrast: 80%, CCT: 6500K, Preset mode: Racing mode, Power Setting: YES).
-



Please refer to the following to alleviate eye strains:

- Users should take some time away from the display if working for long hours. It is advised to take short breaks (at least 5 mins) after around 1 hour of continuous working at the computer. Taking short and frequent breaks is more effective than a single longer break.
 - To minimize eye strain and dryness in your eyes, users should rest the eye periodically by focusing on objects that are far away.
 - Eye exercises can help to reduce eye strain. Repeat these exercises often. If eye strain continues please consult a physician. Eye exercises: (1) Repeating look up and down (2) Slowly roll your eyes (3) Move your eyes diagonal.
 - High energy blue light may lead to eye strain and AMD (Age-Related Macular Degeneration). Blue light filter to reduce 70%(max.) harmful blue light to avoiding CVS (Computer Vision Syndrome).
-

3. Color

Select the image color you like from this function.

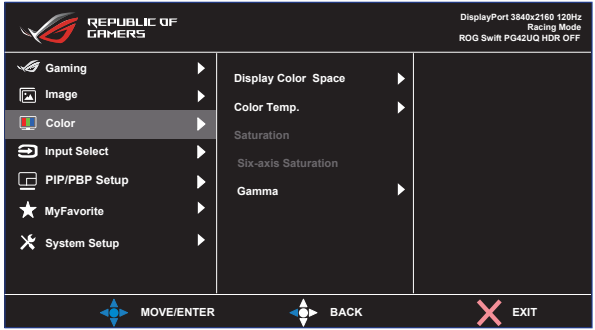

- **Display Color Space:** Select color space to sRGB and DCI-P3.
- **Color Temp.:** Contains seven preset color modes (**4000K, 5000K, 6500K, 7500K, 8200K, 9300K, 10000K**) and **User Mode**.
- **Saturation:** The adjusting range is from 0 to 100.
- **Six-axis Saturation:** Set R/G/B/C/M/Y saturation. The range is from 0 to 100.
- **Gamma:** Contains three gamma modes including 1.8, 2.0, 2.2, 2.4, 2.6.



- In the User Mode, colors of R (Red), G (Green), and B (Blue) are user-configurable; the adjusting range is from 0 ~ 100.

4. Input Select

Select your desired input source and toggle the Auto Input Detection function between on and off. The monitor input source will not automatically switch when the Auto Input Detection function is disabled.

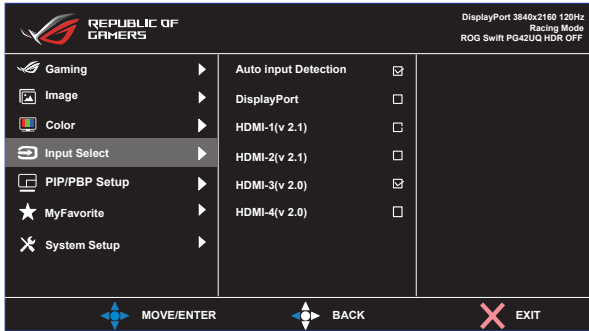

5. PIP/PBP Setup

The PIP/PBP Setting allows you to open up sub-window(s) connected from any video source.

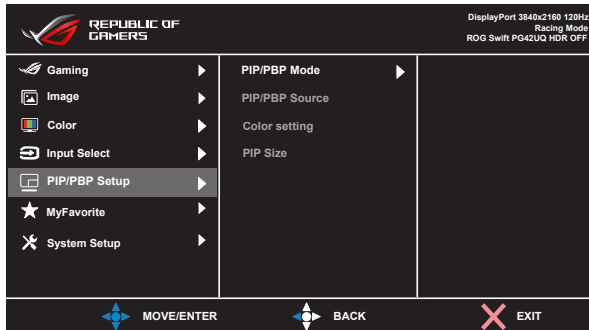

- **PIP/PBP Mode:** Select PIP, PBP or turn it off.
- **PIP/PBP Source:** Selects the video input source among, “DisplayPort, HDMI-1 (v 2.1), HDMI-2 (v 2.1), HDMI-3 (v 2.0), HDMI-4 (v 2.0)”.
- **Color setting:** Set GameVisual mode for each PIP/PBP window.
- **PIP Size:** Adjust the PIP size to “Small”, “Middle”, or “Large”.



- Disable Adaptive-Sync/Variable Refresh Rate and HDR function to enable PIP/PBP function.

6. MyFavorite

Assign a function to the shortcut button, save the current system configurations, or restore the system configuration.

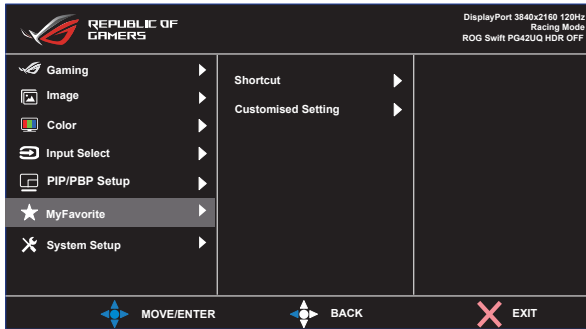

- **Shortcut:** Assign a function for the designated shortcut button.
- **Customized Setting:** Load/Save all settings on the monitor.

8. System Setup

Adjust the system configurations.

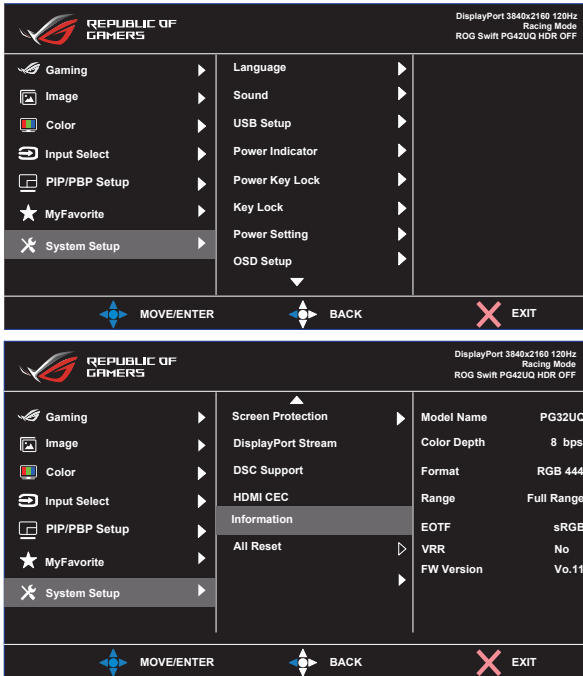

- **Language:** Select OSD language. The selections are: **English, French, German, Spanish, Italian, Dutch, Russian, Poland, Czech, Croatia, Hungary, Romania, Portugal, Turkey, Simplified Chinese, Traditional Chinese, Japanese, Korean, Persian, Thai, Indonesian and Ukrainian.**
- **Sound:** Configure the sound related settings.
 - **Volume:** Adjust the volume level.
 - **Mute:** Enable/Disable the mute function.
 - **Sound Source:** Select the monitor sound comes from which source.
 - **Sound Output:** Set the sound output setting to the speaker, line out, or headphone.
 - **AudioWizard:** Select the sound mode.
- **USB Setup:** Sets the USB Hub availability during standby.
- **Power Indicator:** Turn the power LED indicator on/off.
- **Power Key Lock:** Disable/Enable the Power key.

- **Key Lock:** Enable this function to disable all function keys. Press the **Navigation** button down for more than five seconds to cancel the key lock function.
- **Power Setting:** Select the power setting mode. If the setting is set to **Standard Mode**, it may result in higher power consumption. On the other hand, if the setting is set to **Power Saving Mode**, it may cause limited luminance performance.

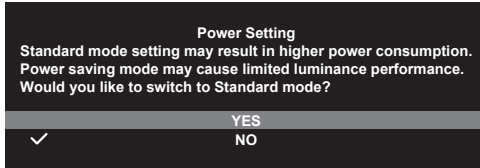

- **OSD Setup:** Configure the OSD menu related settings.
 - **OSD Position:** Set the OSD menu position.
 - **OSD Timeout:** Adjust the OSD timeout.
 - **Transparency:** Adjust the OSD background from opaque to transparent.
 - **Zoom By Remote Control:** Select the OSD menu size when using the remote control.
 - **Zoom by Hot Key:** Select the OSD menu size when using the Control buttons.
 - **DDC/CI:** Enable/Disable the DDC/CI function.
- **Screen Protection:** Configure the screen saver related set up. You can improve the image quality issues related to image retention when the screen is on for a certain amount of time.
 - **Screen Saver:** Enable/disable the screen saver function. The screen brightness will automatically decrease when there is no change on the screen.
 - **Pixel Cleaning:** It calibrates any issues that may arise on the screen when your monitor has been turned on for a long time. The process will take approximately 6 minutes. This function will automatically activate when the monitor is turn off. Do not unplug the power cord while it is in progress.If you power on the monitor, the Pixel Cleaning will stop operating.
 - **Screen Move:** Select the screen movement level to prevent image sticking on the display panel.
 - **Adjust Logo Brightness:** Enable this function to allow the system to automatically adjust the logo brightness to correct the potential picture quality issues.

- **DisplayPort Stream:** Select DisplayPort 1.2 or DisplayPort 1.4 according to the graphic card DP version.
- **DSC:** Enable/Disable the DSC (Display Stream Compression) function.
- **HDMI CEC:** Enable/Disable the HDMI CEC function. If the function is enabled, you can use the remote control to control the devices connected to the monitor through the HDMI ports.
- **Information:** Display the monitor information.
- **All Reset:** Select YES to revert all settings to the factory default mode.

3.3 Specifications

Panel type	OLED
Panel Size	41.5" W (106 cm)
Max. Resolution	3840x2160
Pixel Pitch	0.2395 mm x 0.2395 mm
Brightness	135 nits(Type.)(APL 100%)
Contrast Ratio	1500000:1(APL 25%)Type
Viewing Angle (H/V)	178°(V) /178°(H)
Display Colors	1.07B
Response Time	0.1 ms (G TO G)
Color temperature selection	8 color temperatures
Analog input	No
Digital input	DisplayPort v1.4 x 1, HDMI v2.0 x 2, HDMI v2.1 x 2
Earphone jack	Yes
Audio output	Yes
Speaker (Built-in)	Yes
USB3.0 Port	Downstream x4,Upstream x 1
Colors	Black
Power LED	Red(On)/Orange(Standby)/Blinking Orange(Pixel Cleaning)(The LED is OFF by default)
Tilt	-5° ~ +5°
Swivel	No
Height adjustment	No
VESA wall mount	300 x 300 mm
Kensington lock	Yes
Voltage rating	AC 100-240V, 50/60 Hz
Power consumption	Power On:< 220 W Standby:<0.5 W Power Off:<0.3 W
Temperature (Operating)	0°C ~ 40°C
Temperature (Non-operating)	-20°C ~ +60°C
Dimensions (W x H x D)	932.08 X 611.3 X 255.4 mm(with stand) 932.08 X 551.96 X 37.38 mm(without stand) 1070 x 188 x 870 mm(Package)

Weight (Esti.)	<p>13.58 kg (without stand)</p> <p>14.77 kg (Net)</p> <p>20.07 kg (Gross)</p>
Multi-languages	<p>English, French, German, Spanish, Italian, Dutch, Russian, Poland, Czech, Croacia, Hungary, Romania, Portugal, Turkey, Simplified Chinese, Traditional Chinese, Japanese, Korean, Persian, Thai, Indonesian, Ukrainian</p>
Accessories	<p>DP cable, HDMI cable, USB cable, power cord, quick start guide, warranty card, color calibration testing report, ROG sticker, Input/Output port cover</p>

*Specifications subject to change without notice.

3.3 Troubleshooting (FAQ)

Problem	Possible Solution
Power LED is not ON	<ul style="list-style-type: none"> • Press the  button to check if the monitor is in the ON mode. • Check if the power cord is properly connected to the monitor and the power outlet. • Check Power Indicator function in main menu OSD. Select "ON" to turn on power LED.
The power LED lights amber and there is no screen image	<ul style="list-style-type: none"> • Check if the monitor and the computer are in the ON mode. • Make sure the signal cable is properly connected the monitor and the computer. • Inspect the signal cable and make sure none of the pins are bent. • Connect the computer with another available monitor to check if the computer is properly working.
Screen image is too light or dark	<ul style="list-style-type: none"> • Adjust the Contrast and Brightness settings via OSD.
Screen image bounces or a wave pattern is present in the image	<ul style="list-style-type: none"> • Make sure the signal cable is properly connected to the monitor and the computer. • Move electrical devices that may cause electrical interference.
Screen image has color defects (white does not look white)	<ul style="list-style-type: none"> • Inspect the signal cable and make sure that none of the pins are bent. • Perform Reset via OSD. • Adjust the R/G/B color settings or select the Color Temperature via OSD.
No sound or sound is low	<ul style="list-style-type: none"> • Adjust the volume settings of both your monitor and computer. • Make sure the computer sound card driver is properly installed and activated. • Check the audio source.
The BIOS screen cannot be displayed	<ul style="list-style-type: none"> • Please enable CSM function and Gaming Mode. • * Set Power Setting to Standard Mode.
Power on for longer time	<ul style="list-style-type: none"> • After the monitor is turned off, it will perform the cleaning image sticking in the background. Pressing the power button during cleaning image sticking will abort the action. So, power on the monitor will be slower.

3.4 Supported Timing List

HDMI2.0	DP1.4	HDMI2.1	HDMI2.1(21:9)	DP1.4(21:9)
720x400/70Hz	720x400/70Hz	720x400/70Hz	720x400/70Hz	720x400/70Hz
640x480/60Hz	640x480/60Hz	640x480/60Hz	640x480/60Hz	640x480/60Hz
640x480/67Hz	640x480/67Hz	640x480/67Hz	640x480/67Hz	640x480/67Hz
640x480/72Hz	640x480/72Hz	640x480/72Hz	640x480/72Hz	640x480/72Hz
640x480/75Hz	640x480/75Hz	640x480/75Hz	640x480/75Hz	640x480/75Hz
800x600/56Hz	800x600/56Hz	800x600/56Hz	800x600/56Hz	800x600/56Hz
800x600/60Hz	800x600/60Hz	800x600/60Hz	800x600/60Hz	800x600/60Hz
800x600/72Hz	800x600/72Hz	800x600/72Hz	800x600/72Hz	800x600/72Hz
800x600/75Hz	800x600/75Hz	800x600/75Hz	800x600/75Hz	800x600/75Hz
1024x768/60Hz	1024x768/60Hz	1024x768/60Hz	1024x768/60Hz	1024x768/60Hz
1024x768/70Hz	1024x768/70Hz	1024x768/70Hz	1024x768/70Hz	1024x768/70Hz
1024x768/75Hz	1024x768/75Hz	1024x768/75Hz	1024x768/75Hz	1024x768/75Hz
1280x1024/75Hz	1280x1024/75Hz	1280x1024/75Hz	1280x1024/75Hz	1280x1024/75Hz
1280 x 960 / 60Hz	1280 x 960/60Hz	1280 x 960/60Hz	1280 x 960/60Hz	1280 x 960/60Hz
1280 x 1024 /60Hz	1280 x 1024/60Hz	1280 x 1024/60Hz	1280 x 1024/60Hz	1280 x 1024/60Hz
1440 x 900 / 60Hz	1440 x 900/60Hz	1440 x 900/60Hz	1440 x 900/60Hz	1440 x 900/60Hz
1152 x 864/75Hz	1152 x 864/75Hz	1152 x 864/75Hz	1152 x 864/75Hz	1152 x 864/75Hz
1280 x 720/60Hz	1280 x 720/60Hz	1280 x 720/60Hz	1280 x 720/60Hz	1280 x 720/60Hz
1680 x 1050/60Hz	1680 x 1050/60Hz	1680 x 1050/60Hz	1680 x 1050/60Hz	1680 x 1050/60Hz
1920 x 1080/60Hz	1920 x 1080/60Hz	1920 x 1080/60Hz	1920 x 1080/60Hz	1920 x 1080/60Hz
1280 x 720 P 59.94/60Hz 16:9	1280 x 720 P 59.94/60Hz 16:9	1280 x 720 P 59.94/60Hz 16:9	1280 x 720 P 59.94/60Hz 16:9	1280 x 720 P 59.94/60Hz 16:9
1280 x 720 P 50Hz 16:9	1280 x 720 P 50Hz 16:9	1280 x 720 P 50Hz 16:9	1280 x 720 P 50Hz 16:9	1280 x 720 P 50Hz 16:9
1920 x 1080 P 50Hz 16:9	1920 x 1080 P 50Hz 16:9	1920 x 1080 P 50Hz 16:9	1920 x 1080 P 50Hz 16:9	1920 x 1080 P 50Hz 16:9
1920 x 1080 P 59.94/60Hz 16:9	1920 x 1080 P 59.94/60Hz 16:9	1920 x 1080 P 59.94/60Hz 16:9	1920 x 1080 P 59.94/60Hz 16:9	1920 x 1080 P 59.94/60Hz 16:9
1920 x 1080 P 119.88/120Hz 16:9	1920 x 1080 P 119.88/120Hz 16:9	1920 x 1080 P 119.88/120Hz 16:9	1920 x 1080 P 119.88/120Hz 16:9	1920 x 1080 P 119.88/120Hz 16:9
1920 x 1080 P 100Hz 16:9	1920 x 1080 P 100Hz 16:9	1920 x 1080 P 100Hz 16:9	1920 x 1080 P 100Hz 16:9	1920 x 1080 P 100Hz 16:9
3840 x 2160 P 24Hz 16:9	3840 x 2160 P 100Hz 16:9	3840 x 2160 P 100Hz 16:9	3840 x 2160 P 100Hz 16:9	3840 x 2160 P 100Hz 16:9
3840 x 2160 P 25Hz 16:9	3840 x 2160 P 24Hz 16:9	3840 x 2160 P 24Hz 16:9	3840 x 2160 P 24Hz 16:9	3840 x 2160 P 24Hz 16:9
3840 x 2160 P 30Hz 16:9	3840 x 2160 P 25Hz 16:9	3840 x 2160 P 25Hz 16:9	3840 x 2160 P 25Hz 16:9	3840 x 2160 P 25Hz 16:9
3840 x 2160 P 50Hz 16:9	3840 x 2160 P 30Hz 16:9	3840 x 2160 P 30Hz 16:9	3840 x 2160 P 30Hz 16:9	3840 x 2160 P 30Hz 16:9

3840 x 2160 P 60Hz 16:9	3840 x 2160 P 50Hz 16:9	3840 x 2160 P 50Hz 16:9	3840 x 2160 P 50Hz 16:9	3840 x 2160 P 50Hz 16:9
720 x 480 P 59.94/60Hz 16:9	3840 x 2160 P 60Hz 16:9	3840 x 2160 P 60Hz 16:9	3840 x 2160 P 60Hz 16:9	3840 x 2160 P 60Hz 16:9
720 x 480 P 59.94/60Hz 4:3	3840 x 2160 P 120Hz 16:9	3840 x 2160 P 120Hz 16:9	3840 x 2160 P 120Hz 16:9	3840 x 2160 P 120Hz 16:9
720 x 576 P 50Hz 16:9	1920x2160/60Hz	2560x1440/120Hz	1920x2160/60Hz	2560x1440/120Hz
720 x 576 P 50Hz 4:3	2560x1440/60Hz	2560x1440/60Hz	2560x1440/60Hz	2560x1440/60Hz
1920x2160/60Hz	3840x2160/120Hz	3840x1600/60Hz	3840x1600/60Hz	3840x1600/60Hz
2560x1440/120Hz	3840x1600/120Hz	3440x1440/100Hz	3440x1440/100Hz	3440x1440/100Hz
	3440x1440/120Hz	3440x1440/60Hz	3440x1440/60Hz	3440x1440/60Hz
	3840x1080/120Hz	3840x1080/120Hz	3840x1080/120Hz	3840x1080/120Hz
	2560x1440/120Hz	1920x2160/60Hz	2560x1440/120Hz	1920x2160/60Hz
	3840x2160/138Hz (overclock)	3840x1600/120Hz		
		3440x1440/120Hz		
		3840x1080/120Hz		
		3840x2160/138Hz (overclock)		

*** The modes not listed in the above tables may not be supported. For optimal resolution, we recommend that you choose a mode listed in the above tables.**



CE FC

