

ECLIPSE 440

USER MANUAL

www.azzatek.com

1. Specifications
2. Chassis Parts
3. Control Panel Functions
4. 3.5"/2.5" HDD/SSD Installation
5. Cooling System Installation
6. ARGB Control Board
7. ARGB Control Modes Switching

Specifications

Model	
Model Name:	ECLIPSE 440
Model Number:	CSAZ-440
Specifications	
Type:	ATX Mid Tower
Color:	Black/Black(interior)
Side Panel Window:	Left side panel: tempered glass with rubber mounts
Max CPU Cooler Height:	UP to 160mm
Max Video Card Length:	Up to 390mm long video card
Power Supply:	Not included
Motherboard Compatibility:	EATX · ATX · Micro ATX · ITX
Expansion	
External 5.25" Drive Bays:	0
Internal 2.5" Drive Bays:	Up to 4
Internal 3.5" Drive Bays:	Up to 2
Expansion Slots:	7
Top Ports:	Power button, reset button, Led button, HD Audio, USB 3.0 x 1, USB2.0x2
Physical Specifications	
Case Dimension (HxWxD)	470x215x450/18.5x8.5x17.7 inches
Weight:	6.3kg /13.9lbs
Features	
Tempered Glass Sides Window:	High-quality tempered glass side window allows for clear visuals to inner components
Addressable RGB Light Effects:	All ARGB light sync. devices connected to the ARGB control board, allowing the LED button to directly contrl the ARGB lighting.
Available Fan Ports:	3x120mm or 3x140mm Fan ports in the front (1x120mm ARGB Fan included) 3x120mm or 2x140mm Fan ports on the top 2x120mm Fan ports on the top of PSU shroud 1x120mm Fan port in the rear
Water Cooling:	Supports radiators up to 280/360mm in the Front Supports radiators up to 240/280mm in the Top
Dust Filters:	Removable (magnetic) mesh net on the top, Steel dust filter on bottom of chassis.
Power Supply Support:	Bottom mounted ATX Power Supply
Accessories:	ARGB Controller Board



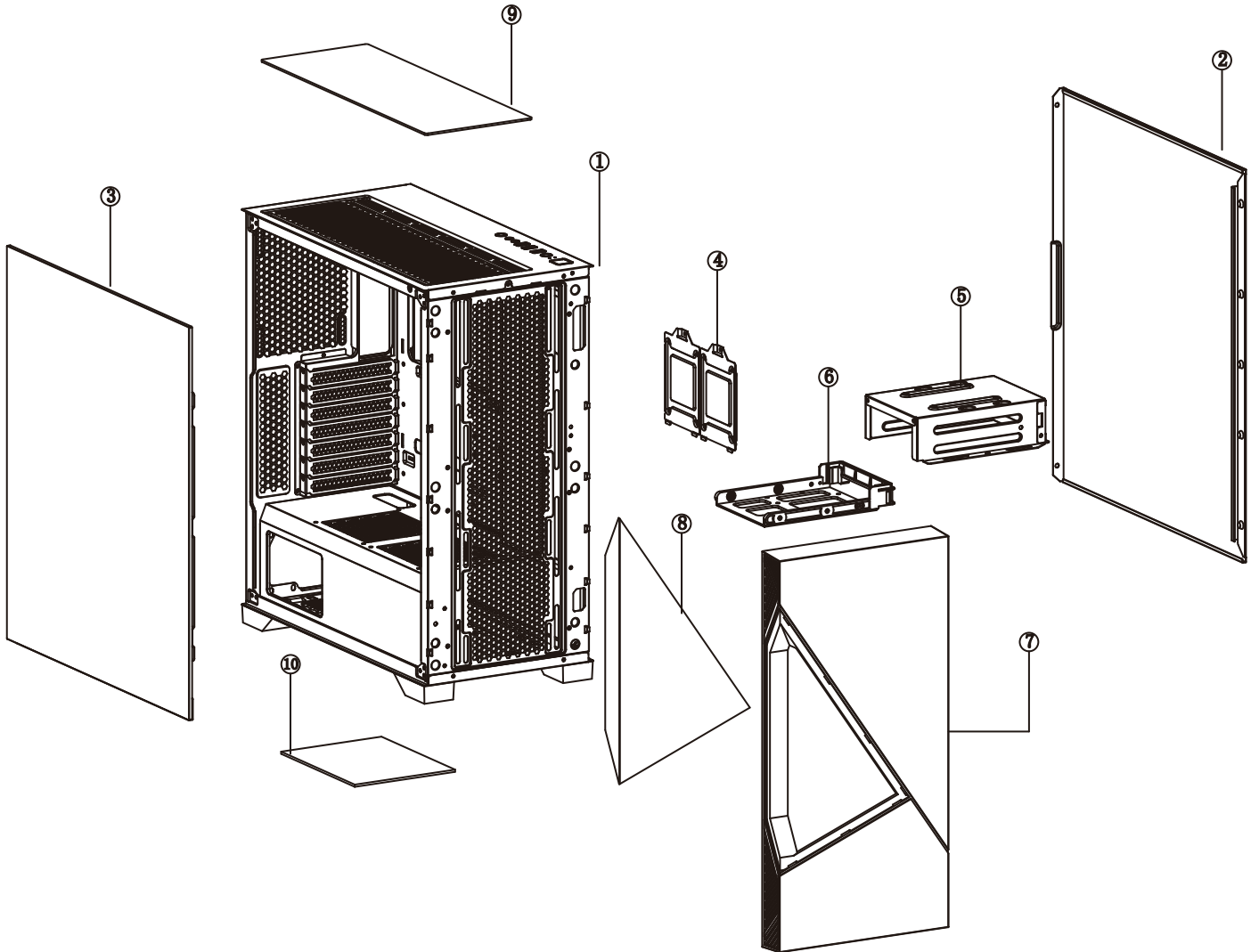

Chassis Parts



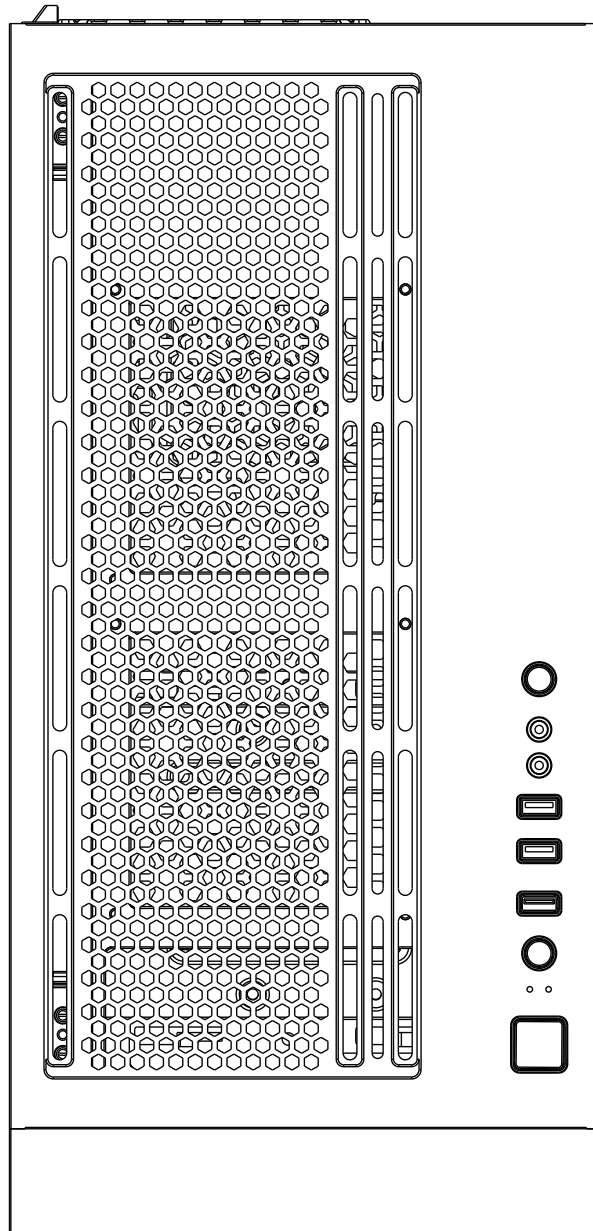

1	Chassis
2	Metal side panel
3	Sliding tempered glass panel
4	2.5" SSD tray x 2
5	Hard disk cage
6	3.5" HDD/ 2.5" SSD brackets
7	Front panel
8	Light guide panel
9	Removable magnetic mesh
10	Steel dust filter

Control Panel Functions



	POWER
	RESET
	LED
	Audio

	USB 3.0 (Blue)
	USB 2.0 (Black)
	Mic

3.5" / 2.5" HDD/SSD Installation

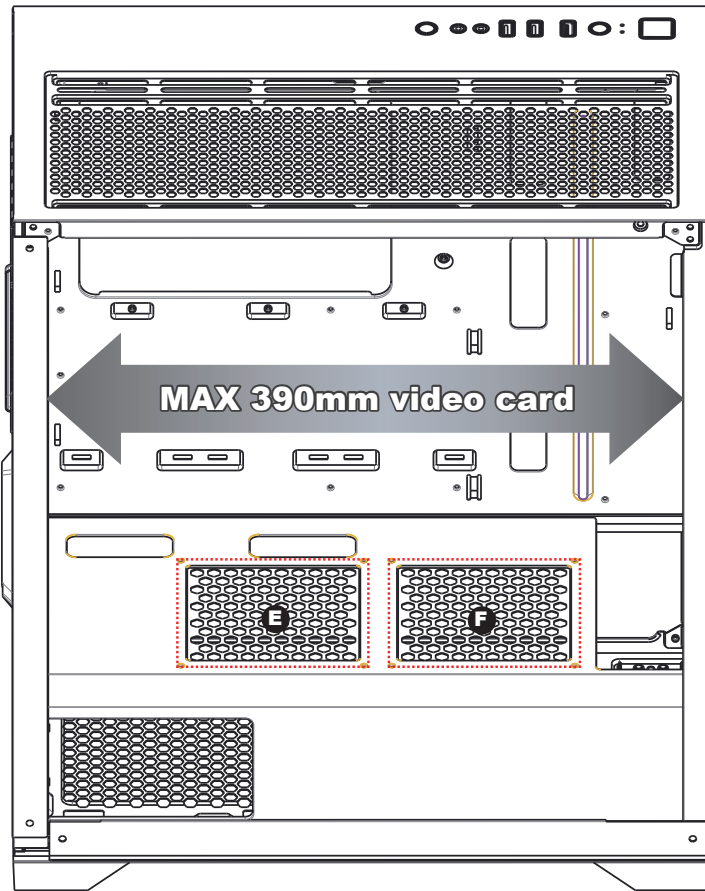

- Supports up to 390mm long video cards.
- Supports up to 120mm fan x2 (**E** **F**)



or

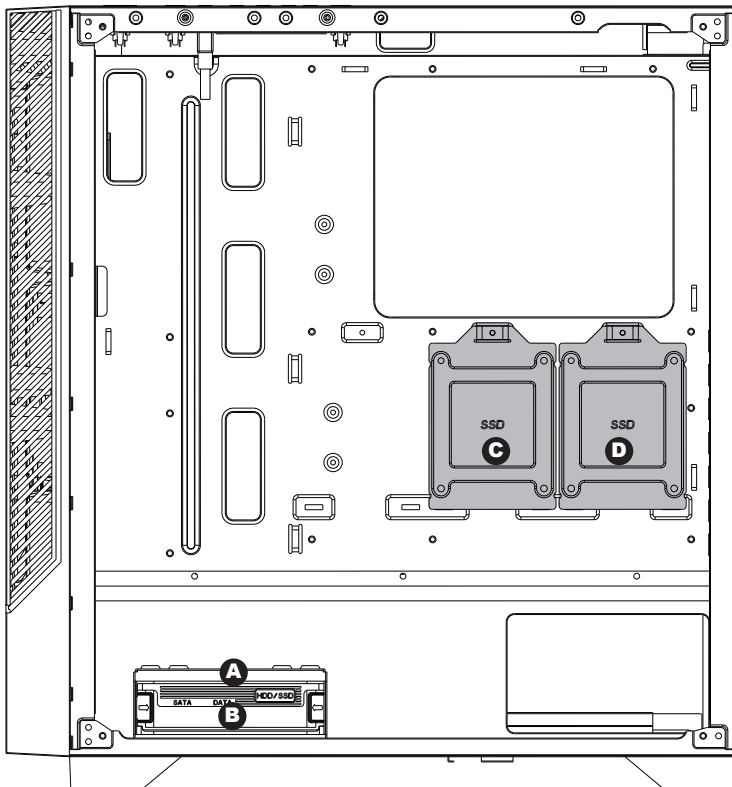
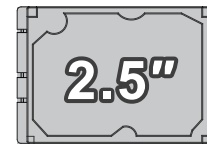

- Multifunctional hard disk cage support
3.5" HDD or 2.5" SSD x 1 (**A**)
- Multifunctional hard disk bracket support
3.5" HDD or 2.5" SSD x 1 (**B**)
- 2.5" SSD metal tray support 2.5" SSD x 2
(**C** **D**)

Front

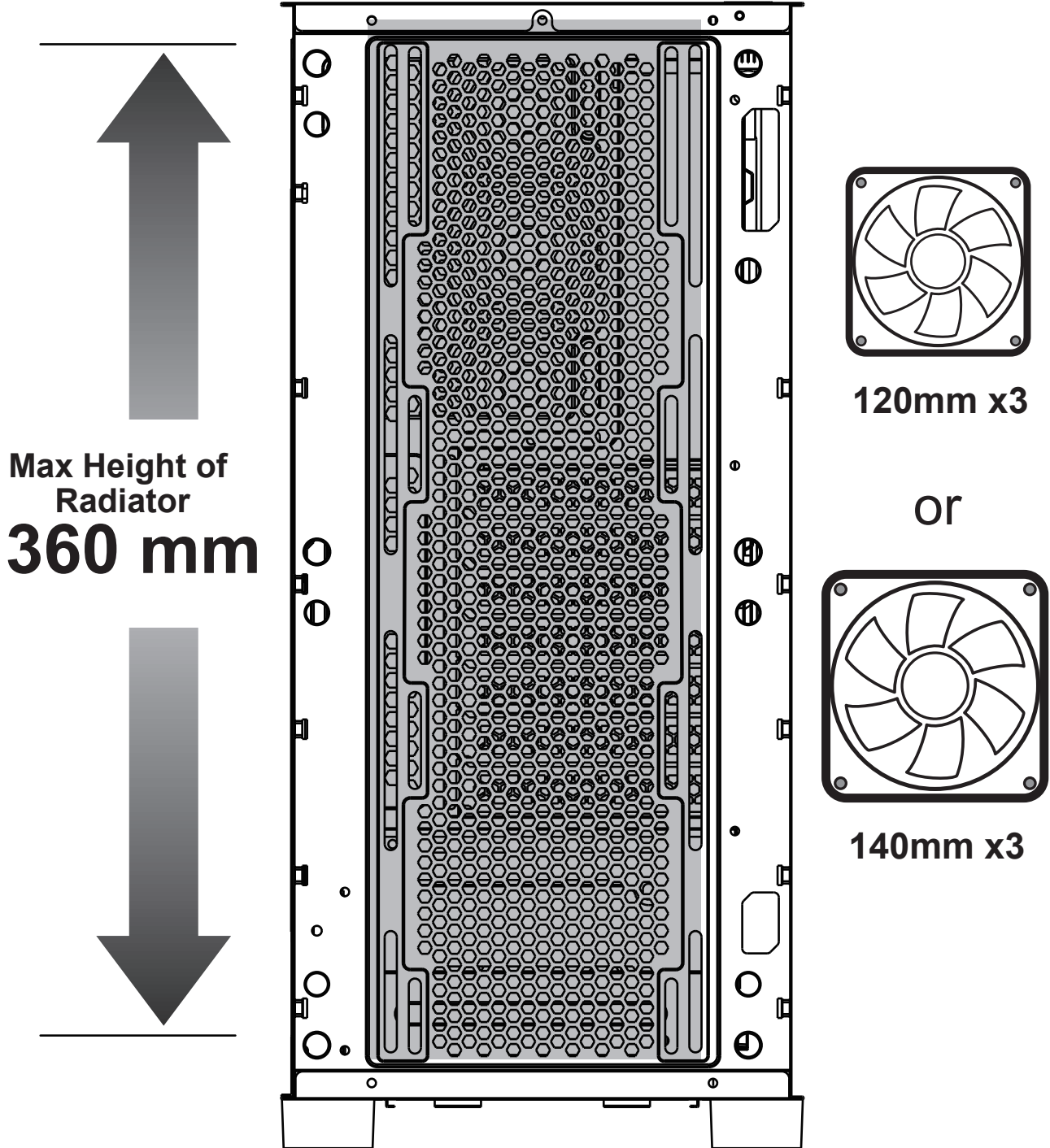

Rear

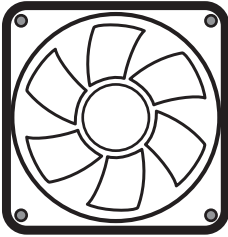
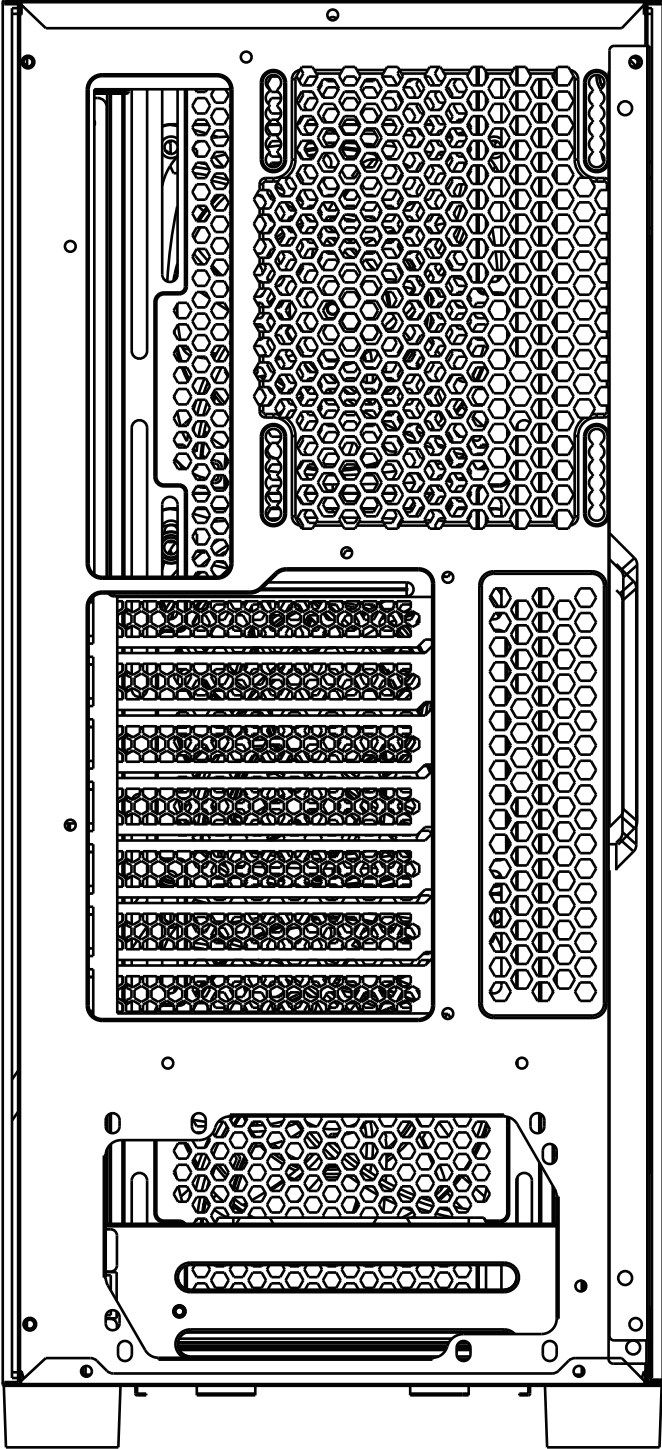

120mm x1

Top

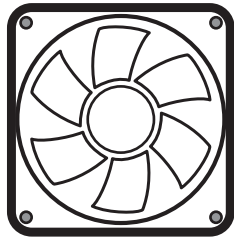

120mm x2

or

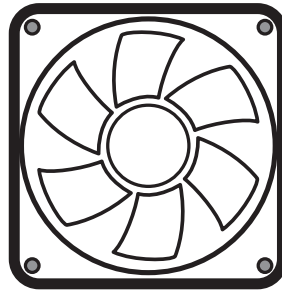

140mm x2

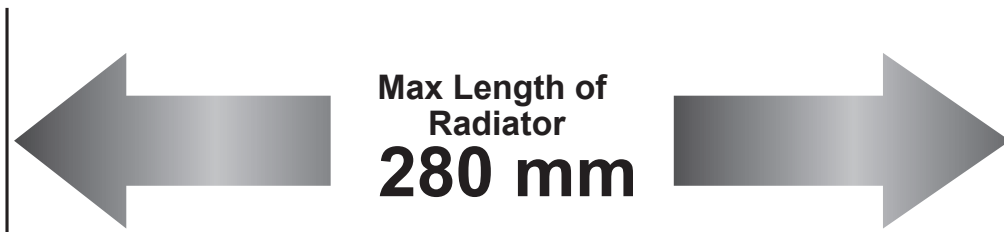
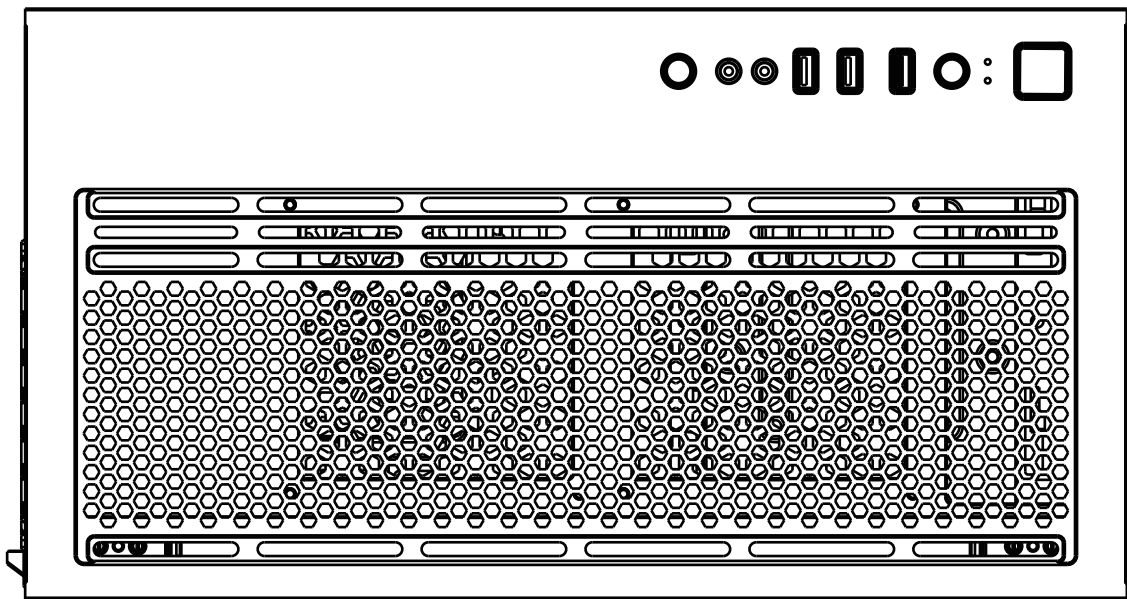

ARGB Control Board

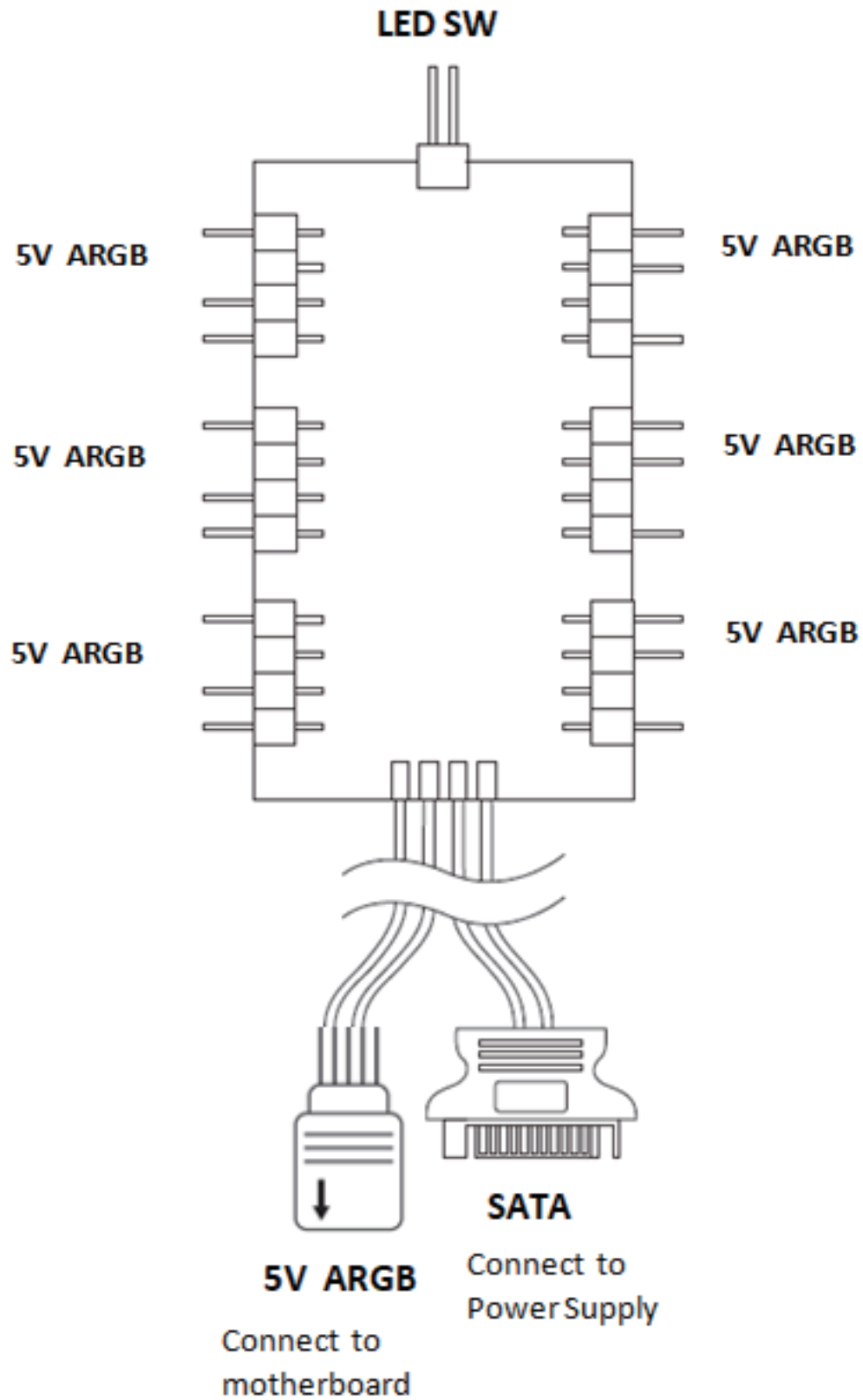

ARGB Control Modes Switching

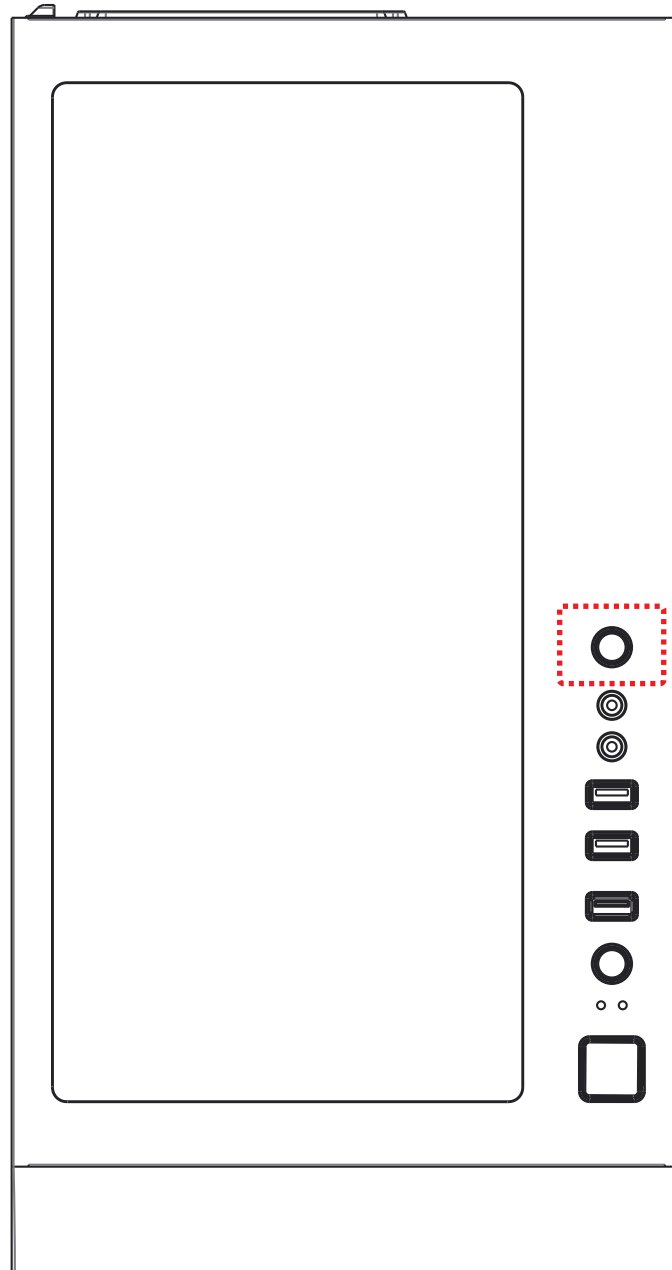

- ※ Press the LED button to cycle through different RGB lighting modes, controlled by the LED button through the ARGB control board.
- ※ Hold the LED button for 3 seconds to switch the RGB control function between motherboard RGB software and LED button.

