

SAB4604NR

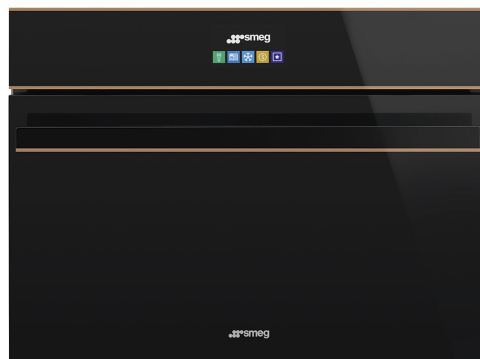

Produktfamilie	Blast Chiller
Produktkategorie	Kompakt 45 cm
Vitality System	Ja
Spannung	Elektrisch
Energiequelle	Elektrisch
Kältekammer/Garraum	
Kühlsystem	Ventiliert





Ästhetik

Ästhetik	Dolce Stil Novo	Glasart	Eclipse-Schwarzglas
Farbe	Schwarz	Gerätetür	Vollverglasung
Oberfläche	Glas	Türgriff	Dolce Stil Novo
Design	Flach	Ausführung des Türgriffs	Schwarz
Verzierung der Komponenten	Kupfer	Markenlogo	Standard
Materialart	Glas		

Programme / Funktionen



Anzahl der ventilierten Wärmefunktionen	5
Automatikprogramme	52
Anzahl der ventilierten Kältefunktionen	5
Automatischer Desinfektion-Reinigungszyklus	

Kältefunktionen

 Schnellkühlen	 Schockfrostern	 Konservierung
--	--	---

 Flaschenkühlung	 Vorkühlung
--	--

Wärmefunktionen

 Niedertemperaturgaren	 Auftauen nach Zeit	 Hefestufe
--	--	---

 Ready to Eat	 Auftauen nach Gewicht
---	---

Bedienelemente



Display	4,3" TFT-Grafik-Farbdisplay mit Klartextanzeige, Touch-Control	Display-Sprachen	IT, EN, FR, NL, SP, PT, SWE, RU, DE, DA, NO, PL, FI
Anzahl der Display-Sprachen	13	Bedienungsart	Touch-Control

Optionen



Türalarm	Ja
Programmuhr/Timer	Elektronisch
Tastensperre/Kindersicherung	Ja
Sonderfunktionen	Uhrzeiteinstellung, Demo-Mode (Showroom Funktion), Tastensperre/Kindersicherung, Spracheneinstellung, Digitaluhr, Signaltöne (Aktivierung/Deaktivierung)
Garen mit Kerntemperaturfühler	Ja
Kühlen mit Kerntemperaturfühler	Ja
Demo-Mode Showroom-Funktion	Ja
Akustische Signaltöne bei Temperaturerreichung, abschaltbar	Standard
Chronologie	Ja, die letzten 10 Funktionen

Technische Eigenschaften

Art des Kompressors	Standard	Art der Einschubschienen	Verchromt
Art des Kältemittels	R290	Art der Beleuchtung	LED
Refrigerant Quantity	130 g	Leistung der Beleuchtung	20 W
Luftschallemissionen	48 dB(A)	Kältekammer-/Garraumbeleuchtung bei Türöffnung	Ja
Temperaturregelung	Elektronisch	Leistung der Oberhitze	250 W
Temperatur min.	-35 °C	Art der Türöffnung	Standard
Temperatur max.	75 °C	Sicherheitsthermostat	Ja
Material der Kältekammer/Garraum	Edelstahl	Sicherheitsabschaltung bei Türöffnung	Ja
Anzahl der Kälte-/Garebenen	3		

Nutzabmessungen der Kältekammer/Garraum (HxBxT) 225 x 475 x 360 mm

Serienzubehör

Ablagerost mit Tiefensperre	1	Kerntemperaturfühler	Ja
Flaschenträger	1	Sonstiges	Mikrofaser Tuch

Elektrischer Anschluss

Netzstecker	(F;E) Schuko	Absicherung	2.5 A
Spannung	220-240 V	Frequenz	50 Hz
Elektrischer Gesamtwert	270 W	Länge des Netzkabels	200 cm

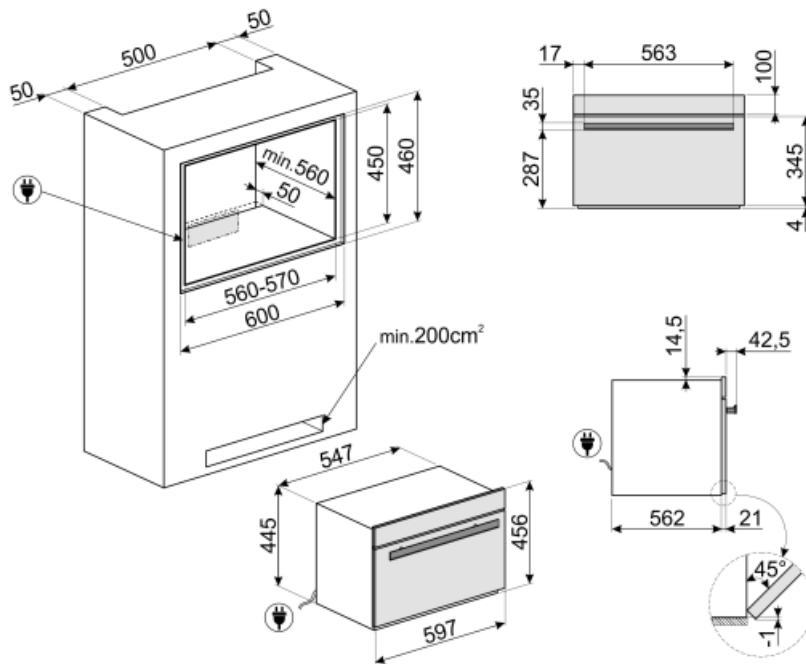



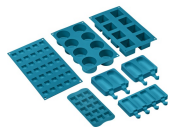











Sonderzubehör



SMOLD

Set aus 7 Silikonformen für Eiscreme, Stieleis, Pralinen, Eiswürfel (Blast-Chiller) und das Vorportionieren von Gerichten. Temperaturbeständig von -60°C bis +230°C (Backöfen).

Symbols glossary (TT)

 <p>Kindersicherung: eine Tastensperre, die eine Bedienung aller Funktionen über das Display sperrt.</p>	 <p>Cooling: It allows to quickly cool the food, from the temperature of 80/90°C to 3°C in less than 90 minutes, to prevent bacterial growth, prolong the average life of food and maintain unaltered the quality of food.</p>
 <p>Cold storage: allows to keep the food at the desired temperature between -35°C and +75°C and serve it at its best to enhance flavours and aromas.</p>	 <p>Pre-cooling: allows the cavity to cool to -30 °C before inserting food into the blast chiller, to ensure the best cooling and freezing results. It is recommended to run a 15-minute pre-cooling cycle.</p>
 <p>Bottles cooling: is possible to quickly cool wine and beverage bottles, reducing the need for storage in the refrigerator, with considerable space savings. Cooling of beverages takes place at about 1°C per minute.</p>	 <p>Deep freezing of the food is a very quick process (From 0/90°C temperature to -18°C in less than 270 min) that allows to extend the average life of food (by up to 70% more) and keep the same organoleptic and nutritional characteristics of fresh food, because it avoid the formation of macro-crystals, that ruin the fibers of the food.</p>
 <p>Elektro-Anschluss</p>	 <p>Automatic cleaning: a drying cycle of the cavity to be run with the door open, to eliminate any condensation formed during use.</p>
 <p>Compact appliances with a height of 45 cm - perfect solution to meet the functional requirements of kitchen sets of small height. Available in several types and in different styles.</p>	 <p>Touch Control: mit der benutzerfreundlichen Touch-Bedienung lässt sich das Gerät per Fingertipp sehr leicht bedienen.</p>
 <p>Ready to eat: This function allows to keep food safely at the refrigerator temperature throughout the day, and heat it just before your return to make it warm, ready to be consumed.</p>	 <p>Low temperature cooking: This function consists in cooking food at a constant temperature, lower than the traditional cooking temperature. Meat results more tender and juicy, maintaining a softness that only this cooking technique allows to obtain.</p>
 <p>Dough leavening/ Yogurt: this function allows you to create the perfect conditions for correct leavening, keeping the mixture at controlled temperatures for the desired time, avoiding sudden changes in humidity levels. This feature also allows the creation of genuine homemade yogurt.</p>	 <p>Thawing by time or by weight: is possible to defrost foods quickly and evenly, without cook the food partially and affect its protein content and with inevitably compromise the quality. The process controls the temperature, preserving the natural moisture and fragrance of the food.</p>
 <p>Thawing by time or by weight: is possible to defrost foods quickly and evenly, without cook the food partially and affect its protein content and with inevitably compromise the quality. The process controls the temperature, preserving the natural moisture and fragrance of the food.</p>	