

ASRock®

FM2A58+ BTC

User Manual



Version 1.0

Published March 2014

Copyright©2014 ASRock INC. All rights reserved.

Copyright Notice:

No part of this documentation may be reproduced, transcribed, transmitted, or translated in any language, in any form or by any means, except duplication of documentation by the purchaser for backup purpose, without written consent of ASRock Inc.

Products and corporate names appearing in this documentation may or may not be registered trademarks or copyrights of their respective companies, and are used only for identification or explanation and to the owners' benefit, without intent to infringe.

Disclaimer:

Specifications and information contained in this documentation are furnished for informational use only and subject to change without notice, and should not be construed as a commitment by ASRock. ASRock assumes no responsibility for any errors or omissions that may appear in this documentation.

With respect to the contents of this documentation, ASRock does not provide warranty of any kind, either expressed or implied, including but not limited to the implied warranties or conditions of merchantability or fitness for a particular purpose.

In no event shall ASRock, its directors, officers, employees, or agents be liable for any indirect, special, incidental, or consequential damages (including damages for loss of profits, loss of business, loss of data, interruption of business and the like), even if ASRock has been advised of the possibility of such damages arising from any defect or error in the documentation or product.

The terms HDMI™ and HDMI High-Definition Multimedia Interface, and the HDMI logo are trademarks or registered trademarks of HDMI Licensing LLC in the United States and other countries.



This device complies with Part 15 of the FCC Rules. Operation is subject to the following two conditions:

- (1) this device may not cause harmful interference, and
- (2) this device must accept any interference received, including interference that may cause undesired operation.

CALIFORNIA, USA ONLY

The Lithium battery adopted on this motherboard contains Perchlorate, a toxic substance controlled in Perchlorate Best Management Practices (BMP) regulations passed by the California Legislature. When you discard the Lithium battery in California, USA, please follow the related regulations in advance.

“Perchlorate Material-special handling may apply, see www.dtsc.ca.gov/hazardouswaste/perchlorate”

ASRock Website: <http://www.asrock.com>

Contents

1. Introduction	1
1.1 Package Contents	1
1.2 Specifications	2
1.3 Unique Features	6
1.4 Motherboard Layout	11
1.5 I/O Panel	13
2. Installation	14
2.1 CPU Installation	15
2.2 Installation of CPU Fan and Heatsink	16
2.3 Installation of Memory Modules (DIMM)	17
2.4 Expansion Slots (PCI and PCI Express Slots)	19
2.5 Jumpers Setup	20
2.6 Onboard Headers and Connectors	21
2.7 CrossFireX™ and Quad CrossFireX™ Operation Guide	25
2.8 AMD Dual Graphics Operation Guide	28
3. Software and Utilities Operation	30
4. UEFI SETUP UTILITY	38
4.1 Introduction	38
4.1.1 UEFI Menu Bar	38
4.1.2 Navigation Keys	39
4.2 Main Screen	39
4.3 OC Tweaker Screen	40

4.4	Advanced Screen	43
4.4.1	CPU Configuration	44
4.4.2	North Bridge Configuration	45
4.4.3	South Bridge Configuration	46
4.4.4	Storage Configuration	47
4.4.5	Super IO Configuration	48
4.4.6	ACPI Configuration	49
4.4.7	USB Configuration	51
4.5	Tool	52
4.6	Hardware Health Event Monitoring Screen	55
4.7	Boot Screen	56
4.8	Security Screen	58
4.9	Exit Screen	59

1. Introduction

Thank you for purchasing ASRock **FM2A58+ BTC** motherboard, a reliable motherboard produced under ASRock's consistently stringent quality control. It delivers excellent performance with robust design conforming to ASRock's commitment to quality and endurance.

In this documentation, Chapter 1 and 2 contains the introduction of the motherboard and step-by-step installation guides. Chapter 3 contains the operation guide of the software and utilities. Chapter 4 contains the configuration guide of the BIOS setup.



Because the motherboard specifications and the BIOS software might be updated, the content of this manual will be subject to change without notice. In case any modifications of this manual occur, the updated version will be available on ASRock website without further notice. You may find the latest VGA cards and CPU support lists on ASRock website as well. ASRock website <http://www.asrock.com>

If you require technical support related to this motherboard, please visit our website for specific information about the model you are using.

www.asrock.com/support/index.asp

1.1 Package Contents

ASRock **FM2A58+ BTC** Motherboard (ATX Form Factor)

ASRock **FM2A58+ BTC** Quick Installation Guide

ASRock **FM2A58+ BTC** Support CD

2 x Serial ATA (SATA) Data Cables (Optional)

1 x I/O Panel Shield

1.2 Specifications

- Platform**
- ATX Form Factor
 - All Solid Capacitor design
 - High Density Glass Fabric PCB

- CPU**
- Supports Socket FM2+ 95W / FM2 100W processors
 - 4 + 2 Power Phase design

- Chipset**
- AMD A58 FCH (Bolton-D2)

- Memory**
- Dual Channel DDR3 Memory Technology
 - 4 x DDR3 DIMM Slots
 - Supports DDR3 2400+(OC)/2133(OC)/1866 (OC)/1600/1333/1066 non-ECC, un-buffered memory **(see CAUTION 1)**
 - Max. capacity of system memory: 64GB **(see CAUTION 2)**
 - Supports Intel® Extreme Memory Profile (XMP) 1.3 / 1.2
 - Supports AMD Memory Profile Technology (AMP) up to AMP 2400
 - 15µ Gold Contact in DIMM Slots

- Expansion Slot**
- 1 x PCI Express 3.0 x16 Slot (PCIe4 @ x16 mode)
* PCIe 3.0 is only supported with FM2+ CPU. With FM2 CPU, it only supports PCIe 2.0.
 - 1 x PCI Express 2.0 x16 Slot (PCIe5 @ x4 mode)
 - 3 x PCI Express 2.0 x1 Slots
 - 2 x PCI Slots
 - Supports AMD Quad CrossFireX™, CrossFireX™ and Dual Graphics
 - 15µ Gold Contact in VGA PCIe Slot (PCIe4)

- Graphics**
- Integrated AMD Radeon™ R7/R5 Series Graphics in A-series APU
 - DirectX 11.1, Pixel Shader 5.0 with FM2+ CPU. DirectX 11, Pixel Shader 5.0 with FM2 CPU.
 - Max. shared memory 2GB
 - Dual VGA output: support DVI-D and D-Sub by independent display controllers
 - Supports Dual-link DVI-D with max. resolution up to 2560x1600 @ 60Hz

- Supports D-Sub with max. resolution up to 1920x1200 @ 60Hz
- Supports AMD Steady Video™ 2.0: New video post processing capability for automatic jitter reduction on home/online video
- Supports HDCP with DVI-D Port
- Supports Full HD 1080p Blu-ray (BD) playback with DVI-D Port

Audio

- 5.1 CH HD Audio (Realtek ALC662 Audio Codec)
- Supports Surge Protection (ASRock Full Spike Protection)
- TI® NE5532 Premium Headset Amplifier (Supports up to 600 ohm headsets) (Line-Out on rear I/O only)

LAN

- PCIE x1 Gigabit LAN 10/100/1000 Mb/s
- Realtek RTL8111GR
- Supports Wake-On-WAN (**see CAUTION 3**)
- Supports Wake-On-LAN
- Supports Lightning/ESD Protection (ASRock Full Spike Protection)
- Supports LAN Cable Detection
- Supports Energy Efficient Ethernet 802.3az
- Supports PXE

Rear Panel I/O

- 1 x PS/2 Mouse Port
- 1 x PS/2 Keyboard Port
- 1 x D-Sub Port
- 1 x DVI-D Port
- 6 x USB 2.0 Ports (Supports ESD Protection (ASRock Full Spike Protection))
- 1 x RJ-45 LAN Port with LED (ACT/LINK LED and SPEED LED)
- HD Audio Jacks: Line in / Front Speaker / Microphone

Storage

- 6 x SATA2 3.0 Gb/s Connectors, support RAID (RAID 0, RAID 1 and RAID 10), NCQ, AHCI and Hot Plug

- Connector**
- 1 x COM Port Header
 - 1 x Power LED Header
 - 2 x CPU Fan Connectors (1 x 4-pin, 1 x 3-pin)
 - 3 x Chassis Fan Connectors (1 x 4-pin, 2 x 3-pin)
 - 1 x Power Fan Connector (3-pin)
 - 1 x 24 pin ATX Power Connector
 - 1 x 8 pin 12V Power Connector
 - 1 x PCIe Power Connector
 - 1 x Front Panel Audio Connector
 - 1 x USB Power Jumper (Ultra USB Power)
 - 2 x USB 2.0 Headers (Support 4 USB 2.0 ports)
(Supports ESD Protection (ASRock Full Spike Protection))

- BIOS Feature**
- 64Mb AMI UEFI Legal BIOS with GUI support
 - Supports “Plug and Play”
 - ACPI 1.1 Compliant wake up events
 - Supports jumperfree
 - SMBIOS 2.3.1 support
 - DRAM, CPU Voltage multi-adjustment

- Support CD**
- Drivers, Utilities, AntiVirus Software (Trial Version), Google Chrome Browser and Toolbar, Start8 (30 days trial)

- Hardware Monitor**
- CPU temperature sensing
 - Chassis temperature sensing
 - CPU Fan Tachometer
 - Chassis Fan Tachometer
 - CPU/Chassis Quiet Fan
 - CPU/Chassis Fan multi-speed control
 - Voltage monitoring: +12V, +5V, +3.3V, Vcore

- OS**
- Microsoft® Windows® 10 32-bit / 10 64-bit / 8.1 32-bit / 8.1 64-bit / 8 32-bit / 8 64-bit / 7 32-bit / 7 64-bit
 - * For the updated Windows® 10 driver, please visit ASRock’s website for details: <http://www.asrock.com>
 - * Carrizo FM2r2 processor supports Windows® 10 64-bit / 8.1 64-bit / 7 32-bit / 7 64-bit only.

Certifications

- FCC, CE, WHQL
- ErP/EuP ready (ErP/EuP ready power supply is required)

* For detailed product information, please visit our website: <http://www.asrock.com>

WARNING

Please realize that there is a certain risk involved with overclocking, including adjusting the setting in the BIOS, applying Untied Overclocking Technology, or using third-party overclocking tools. Overclocking may affect your system's stability, or even cause damage to the components and devices of your system. It should be done at your own risk and expense. We are not responsible for possible damage caused by overclocking.

CAUTION!

1. Whether 2400/2133/1866/1600MHz memory speed is supported depends on the CPU you adopt. If you want to adopt DDR3 1866/1600 memory module on this motherboard, please refer to the memory support list on our website for the compatible memory modules.
ASRock website <http://www.asrock.com>
2. Due to the operating system limitation, the actual memory size may be less than 4GB for the reservation for system usage under Windows® 10 / 8.1 / 8 / 7. For Windows® 64-bit OS with 64-bit CPU, there is no such limitation. You can use ASRock XFast RAM to utilize the memory that Windows® cannot use.
3. Wake-On-WAN allows you to wake up this system from remote mobile devices, such as smart phones, tables, or other PCs. It needs third-party softwares and applications to utilize this feature. Please visit our website for Home Cloud topic.

1.3 Unique Features



ASRock A-Tuning

A-Tuning is ASRock's multi purpose software suite with a new interface, more new features and improved utilities, including XFast RAM, Dehumidifier, Good Night LED, FAN-Tastic Tuning, OC Tweaker and a whole lot more.



ASRock iCafe BIOS Menu

In our specialized BIOS menu designed for Internet Cafes, many functions are relocated for easier access and optimized for management. You can setup the BIOS more conveniently now.



ASRock Instant Boot

ASRock Instant Boot allows you to turn on your PC in just a few seconds, provides a much more efficient way to save energy, time, money, and improves system running speed for your system. It leverages the S3 and S4 ACPI features which normally enable the Sleep/Standby and Hibernation modes in Windows® to shorten boot up time. By calling S3 and S4 at specific timing during the shutdown and startup process, Instant Boot allows you to enter your Windows® desktop in a few seconds.



ASRock Instant Flash

ASRock Instant Flash is a BIOS flash utility embedded in Flash ROM. This convenient BIOS update tool allows you to update system BIOS without entering operating systems first like MS-DOS or Windows®. With this utility, you can press the <F6> key during the POST or the <F2> key to enter into the BIOS setup menu to access ASRock Instant Flash. Just launch this tool and save the new BIOS file to your USB flash drive, floppy disk or hard drive, then you can update your BIOS only in a few clicks without preparing an additional floppy diskette or other complicated flash utility. Please be noted that the USB flash drive or hard drive must use FAT32/16/12 file system.



ASRock APP Charger

If you desire a faster, less restricted way of charging your Apple devices, such as iPhone/iPad/iPod Touch, ASRock has prepared a wonderful solution for you - ASRock APP Charger. Simply install the APP Charger driver, it makes your iPhone charge much quickly from your computer and up to 40% faster than before. ASRock APP Charger allows you to quickly charge many Apple devices simultaneously and even supports continuous charging when your PC enters into Standby mode (S1), Suspend to RAM (S3), hibernation mode (S4) or power off (S5). With APP Charger driver installed, you can easily enjoy the marvelous charging experience.



ASRock XFast LAN

ASRock XFast LAN provides a faster internet access, which includes the benefits listed below. LAN Application Prioritization: You can configure your application's priority ideally and/or add new programs. Lower Latency in Game: After setting online game's priority higher, it can lower the latency in games. Traffic Shaping: You can watch Youtube HD videos and download simultaneously. Real-Time Analysis of Your Data: With the status window, you can easily recognize which data streams you are transferring currently.



ASRock XFast RAM

ASRock XFast RAM is included in A-Tuning. It fully utilizes the memory space that cannot be used under Windows® 32-bit operating systems. ASRock XFast RAM shortens the loading time of previously visited websites, making web surfing faster than ever. And it also boosts the speed of Adobe Photoshop 5 times faster. Another advantage of ASRock XFast RAM is that it reduces the frequency of accessing your SSDs or HDDs in order to extend their lifespan.



ASRock Crashless BIOS

ASRock Crashless BIOS allows users to update their BIOS without fear of failing. If power loss occurs during the BIOS update process, ASRock Crashless BIOS will automatically finish the BIOS update procedure after regaining power. Please note that BIOS files need to be placed in the root directory of your USB disk. Only USB2.0 ports support this feature.



ASRock OMG (Online Management Guard)

Administrators are able to establish an internet curfew or restrict internet access at specified times via OMG. You may schedule the starting and ending hours of internet access granted to other users. In order to prevent users from bypassing OMG, guest accounts without permission to modify the system time are required.



ASRock Internet Flash

ASRock Internet Flash searches for available UEFI firmware updates from our servers. In other words, the system can auto-detect the latest UEFI from our servers and flash them without entering Windows® OS.



ASRock UEFI System Browser

ASRock UEFI system browser is a useful tool included in graphical UEFI. It can detect the devices and configurations that users are currently using in their PC. With the UEFI system browser, you can easily examine the current system configuration in UEFI setup.



ASRock UEFI Tech Service

Contact ASRock Tech Service by sending a support request from the UEFI setup utility if you are having trouble with your PC.



ASRock Dehumidifier Function

Users may prevent motherboard damages due to dampness by enabling “Dehumidifier Function”. When enabling Dehumidifier Function, the computer will power on automatically to dehumidify the system after entering S4/S5 state.



ASRock Easy RAID Installer

ASRock Easy RAID Installer can help you to copy the RAID driver from a support CD to your USB storage device. After copying the RAID driver to your USB storage device, please change “SATA Mode” to “RAID”, then you can start installing the OS in RAID mode.



ASRock Easy Driver Installer

For users that don't have an optical disk drive to install the drivers from our support CD, Easy Driver Installer is a handy tool in the UEFI that installs the LAN driver to your system via an USB storage device, then downloads and installs the other required drivers automatically.



ASRock Interactive UEFI

ASRock Interactive UEFI is a blend of system configuration tools, cool sound effects and stunning visuals. The unprecedented UEFI provides a more attractive interface and brings a lot more amusing.



ASRock Fast Boot

With ASRock's exclusive Fast Boot technology, it takes less than 1.5 seconds to logon to Windows® 8 from a cold boot. No more waiting! The speedy boot will completely change your user experience and behavior.



ASRock X-Boost

Brilliantly designed for combo overclocking, ASRock X-Boost Technology is able to unleash the hidden power of your CPUs. Simply press "X" when turning on the PC, X-Boost will automatically overclock the relative components to get up to 15.77% performance boost! With the smart X-Boost, overclocking CPU can become a near one-button process.



ASRock Restart to UEFI

Windows® 8 brings the ultimate boot up experience. The lightning boot up speed makes it hard to access the UEFI setup. ASRock Restart to UEFI technology is designed for those requiring frequent UEFI access. It is included in ASRock's exclusive all-in-one A-Tuning tuning program that allows users to easily enter the UEFI automatically when turning on the PC next time. Just simply enable this function; the PC will be assured to access the UEFI directly in the very beginning.



ASRock Good Night LED

ASRock Good Night LED technology offers you a better sleeping environment by extinguishing the unessential LEDs. By enabling Good Night LED in the BIOS, the LAN/Power/HDD LEDs will be switched off when the system is powered on. Good Night LED will automatically switch off the Power and Keyboard LEDs when the system enters into Standby/Hibernation mode as well.



ASRock USB Key

In a world where time is money, why waste precious time everyday typing usernames to log in to Windows? Why should we even bother memorizing those foot long passwords? Just plug in the USB Key and let your computer log in to windows automatically!



ASRock FAN-Tastic Tuning

ASRock FAN-Tastic Tuning is included in A-Tuning. Configure up to five different fan speeds using the graph. The fans will automatically shift to the next speed level when the assigned temperature is met.

No.	Description
1	ATX 12V Power Connector (ATX12V1)
2	CPU Fan Connector (CPU_FAN1)
3	CPU Fan Connector (CPU_FAN2)
4	2 x 240-pin DDR3 DIMM Slots (DDR3_A1, DDR3_B1)
5	2 x 240-pin DDR3 DIMM Slots (DDR3_A2, DDR3_B2)
6	ATX Power Connector (ATXPWR1)
7	Chassis Fan Connector (CHA_FAN2)
8	SATA2 Connectors (SATA_5_6)
9	SATA2 Connectors (SATA_3_4)
10	SATA2 Connectors (SATA_1_2)
11	System Panel Header (PANEL1)
12	Clear CMOS Jumper (CLR_CMOS1)
13	Chassis Fan Connector (CHA_FAN3)
14	Power LED Header (PLED1)
15	Chassis Speaker Header (SPEAKER1)
16	USB 2.0 Header (USB8_9)
17	USB 2.0 Header (USB6_7)
18	COM Port Header (COM1)
19	Front Panel Audio Header (HD_AUDIO1)
20	Power Fan Connector (PWR_FAN1)
21	Chassis Fan Connector (CHA_FAN1)
22	PCIe Power Connector (PCIE_PWR1)
23	USB Power Jumper (USB01_PWR1) (only for the USB01 ports)

1.5 I/O Panel

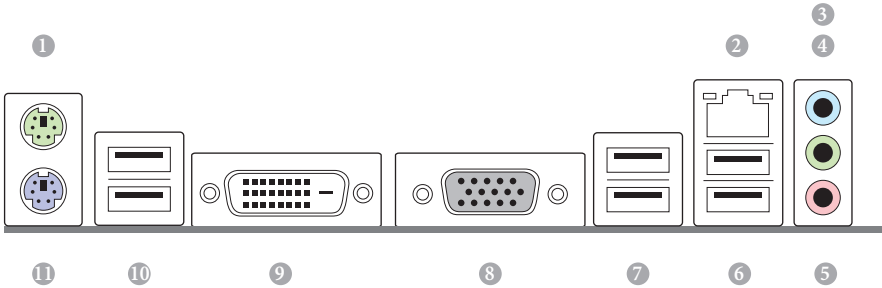

No.	Description	No.	Description
1	PS/2 Mouse Port (Green)	7	USB 2.0 Ports (USB23)
2	LAN RJ-45 Port*	8	D-Sub Port (VGA1)
3	Line In (Light Blue)	9	DVI-D Port (DVI1)
4	Front Speaker (Lime)	10	USB 2.0 Ports (USB01)
5	Microphone (Pink)	11	PS/2 Keyboard Port (Purple)
6	USB 2.0 Ports (USB45)		

* There are two LEDs on the LAN port. Please refer to the table below for the LAN port LED indications.

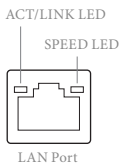

Activity / Link LED		Speed LED	
Status	Description	Status	Description
Off	No Link	Off	10Mbps connection
Blinking	Data Activity	Orange	100Mbps connection
On	Link	Green	1Gbps connection

2. Installation

This is an ATX form factor motherboard. Before you install the motherboard, study the configuration of your chassis to ensure that the motherboard fits into it.

Pre-installation Precautions

Take note of the following precautions before you install motherboard components or change any motherboard settings.



Before you install or remove any component, ensure that the power is switched off or the power cord is detached from the power supply. Failure to do so may cause severe damage to the motherboard, peripherals, and/or components.

1. Unplug the power cord from the wall socket before touching any component.
2. To avoid damaging the motherboard components due to static electricity, NEVER place your motherboard directly on the carpet or the like. Also remember to use a grounded wrist strap or touch a safety grounded object before you handle components.
3. Hold components by the edges and do not touch the ICs.
4. Whenever you uninstall any component, place it on a grounded anti-static pad or in the bag that comes with the component.
5. When placing screws into the screw holes to secure the motherboard to the chassis, please do not over-tighten the screws! Doing so may damage the motherboard.

2.1 CPU Installation

Step 1. Unlock the socket by lifting the lever up to a 90° angle.

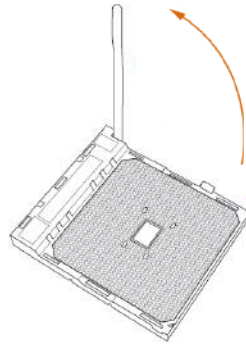

Step 2. Position the CPU directly above the socket such that the CPU corner with the golden triangle matches the socket corner with a small triangle.

Step 3. Carefully insert the CPU into the socket until it fits in place.



The CPU fits only in one correct orientation. DO NOT force the CPU into the socket to avoid bending of the pins.

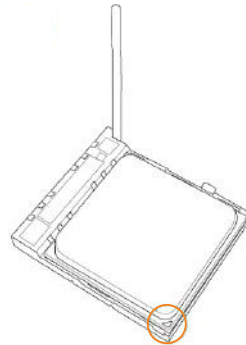

Step 4. When the CPU is in place, press it firmly on the socket while you push down the socket lever to secure the CPU. The lever clicks on the side tab to indicate that it is locked.

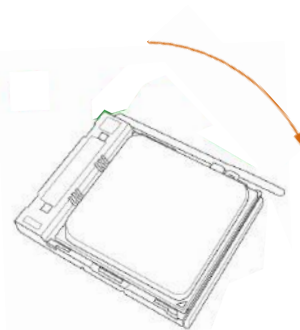

2.2 Installation of CPU Fan and Heatsink

After you install the CPU into this motherboard, it is necessary to install a larger heatsink and cooling fan to dissipate heat. You also need to spray thermal grease between the CPU and the heatsink to improve heat dissipation. Make sure that the CPU and the heatsink are securely fastened and in good contact with each other. Then connect the CPU fan to the CPU FAN connector (CPU_FAN1 and CPU_FAN2, see Page 11, No. 2 and No. 3). For proper installation, please kindly refer to the instruction manuals of the CPU fan and the heatsink.

2.3 Installation of Memory Modules (DIMM)

This motherboard provides four 240-pin DDR3 (Double Data Rate 3) DIMM slots, and supports Dual Channel Memory Technology.



1. For dual channel configuration, you always need to install identical (the same brand, speed, size and chip-type) DDR3 DIMM pairs.
2. It is unable to activate Dual Channel Memory Technology with only one or three memory module installed.
3. It is not allowed to install a DDR or DDR2 memory module into a DDR3 slot; otherwise, this motherboard and DIMM may be damaged.
4. If you adopt DDR3 1866/1600 memory modules on this motherboard, it is recommended to install them on DDR3_A2 and DDR3_B2 slots.

Dual Channel Memory Configuration

Priority	DDR3_A1	DDR3_A2	DDR3_B1	DDR3_B2
1	Populated		Populated	
2		Populated		Populated
3	Populated	Populated	Populated	Populated



The DIMM only fits in one correct orientation. It will cause permanent damage to the motherboard and the DIMM if you force the DIMM into the slot at incorrect orientation.

1

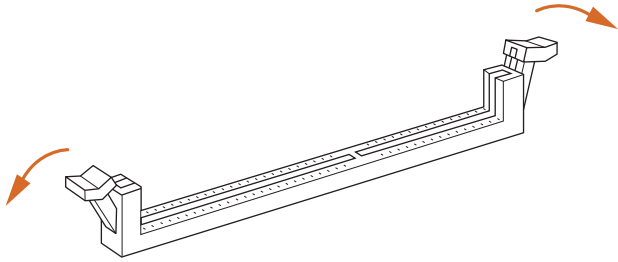

2

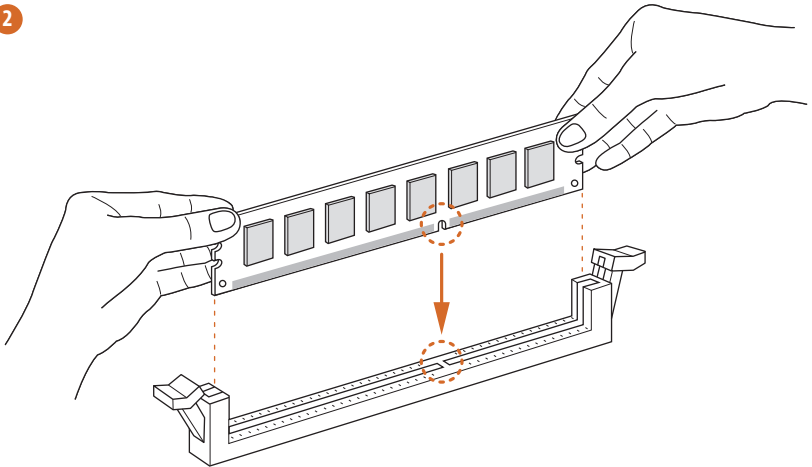

3

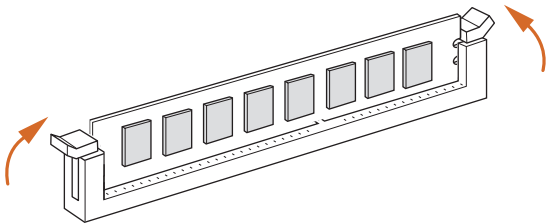

2.4 Expansion Slots (PCI and PCI Express Slots)

There are 2 PCI slots and 5 PCI Express slots on this motherboard.



Before installing an expansion card, please make sure that the power supply is switched off or the power cord is unplugged. Please read the documentation of the expansion card and make necessary hardware settings for the card before you start the installation.

PCI Slots: PCI slots are used to install expansion cards that have the 32-bit PCI interface.

PCIe Slots:

PCIe1 / PCIe2 / PCIe3 (PCIe 2.0 x1 slot) is used for PCI Express cards with x1 lane width cards

PCIe4 (PCIe 3.0 x16 slot) is used for PCI Express x16 lane width graphics cards

PCIe5 (PCIe 2.0 x16 slot) is used for PCI Express x4 lane width cards

PCIe Slot Configurations

	PCIe4	PCIe5
Single Graphics Card	x16	N/A
Two Graphics Cards in CrossFireX™ Mode	x16	x4





For a better thermal environment, please connect a chassis fan to the motherboard's chassis fan connector (CHA_FAN1, CHA_FAN2, or CHA_FAN3) when using multiple graphics cards.

2.5 Jumpers Setup

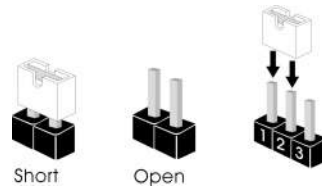
The illustration shows how jumpers are setup. When the jumper cap is placed on pins, the jumper is “Short”. If no jumper cap is placed on pins, the jumper is “Open”. The illustration shows a 3-pin jumper whose pin1 and pin2 are “Short” when jumper cap is placed on these 2 pins.



Jumper	Setting	Description
Clear CMOS Jumper (CLRCMOS1) (see p.11, No. 12)	<div style="display: flex; justify-content: space-around;"> <div style="text-align: center;"> <p>1_2</p>  <p>Default</p> </div> <div style="text-align: center;"> <p>2_3</p>  <p>Clear CMOS</p> </div> </div>	

Note: CLRCMOS1 allows you to clear the data in CMOS. To clear and reset the system parameters to default setup, please turn off the computer and unplug the power cord from the power supply. After waiting for 15 seconds, use a jumper cap to short pin2 and pin3 on CLRCMOS1 for 5 seconds. However, please do not clear the CMOS right after you update the BIOS. If you need to clear the CMOS when you just finish updating the BIOS, you must boot up the system first, and then shut it down before you do the clear-CMOS action. Please be noted that the password, date, time, user default profile, 1394 GUID and MAC address will be cleared only if the CMOS battery is removed.

USB Power Jumper (3-pin USB01_PWR1) (see p.11, No. 23)	<div style="text-align: center;"> <p>1_2</p>  <p>+5V (Default)</p> </div>	<div style="text-align: center;"> <p>2_3</p>  <p>+5VSB</p> </div>
--	--	--

Note: USB Power Jumper is specifically designed for users who use LED keyboard / mouse. (only for the USB01 ports)

Pin 1-2 shorted (default):

Stable voltage and high current is provided for LED keyboard / mouse. The backlight of your keyboard / mouse will be OFF when the PC is off.

Pin 2-3 shorted:

+5VSB voltage is provided for LED keyboard / mouse. Enable the wake-up function of your keyboard / mouse. The backlight of your keyboard / mouse will be ON when the PC is in standby mode.

2.6 Onboard Headers and Connectors



Onboard headers and connectors are NOT jumpers. Do NOT place jumper caps over these headers and connectors. Placing jumper caps over the headers and connectors will cause permanent damage of the motherboard!

Serial ATA2 Connectors

(SATA_1_2: see p.11, No. 10)

(SATA_3_4: see p.11, No. 9)

(SATA_5_6: see p.11, No. 8)



These six Serial ATA2 (SATA2) connectors support SATA data cables for internal storage devices. The current SATA2 interface allows up to 3.0 Gb/s data transfer rate.

USB 2.0 Headers

(9-pin USB6_7)

(see p.11 No. 17)

(9-pin USB8_9)

(see p.11 No. 16)

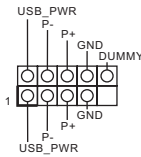

Besides six default USB 2.0 ports on the I/O panel, there are two USB 2.0 headers on this motherboard. Each USB 2.0 header can support two USB 2.0 ports.

Front Panel Audio Header

(9-pin HD_AUDIO1)

(see p.11 No.19)

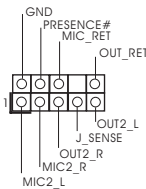

This is an interface for the front panel audio cable that allows convenient connection and control of audio devices.



1. High Definition Audio supports Jack Sensing, but the panel wire on the chassis must support HDA to function correctly. Please follow the instruction in our manual and chassis manual to install your system.
2. If you use AC'97 audio panel, please install it to the front panel audio header as below:
 - A. Connect Mic_IN (MIC) to MIC2_L.
 - B. Connect Audio_R (RIN) to OUT2_R and Audio_L (LIN) to OUT2_L.
 - C. Connect Ground (GND) to Ground (GND).
 - D. MIC_RET and OUT_RET are for HD audio panel only. You don't need to connect them for AC'97 audio panel.

Chassis Speaker Header

(4-pin SPEAKER 1)

(see p.11 No. 15)

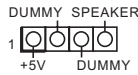

Please connect the chassis speaker to this header.

Power LED Header

(3-pin PLED1)

(see p.11 No. 14)

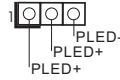

Please connect the chassis power LED to this header to indicate system power status. The LED is on when the system is operating. The LED keeps blinking in S1 state. The LED is off in S3/S4 state or S5 state (power off).

Chassis and Power Fan Connectors

(4-pin CHA_FAN1)

(see p.11 No. 21)

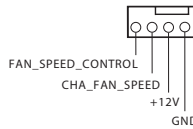

Please connect the fan cable to the fan connector and match the black wire to the ground pin.

(3-pin CHA_FAN2)

(see p.11 No. 7)

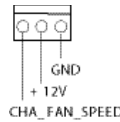

(3-pin CHA_FAN3)

(see p.11 No. 13)

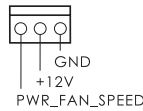

(3-pin PWR_FAN1)

(see p.11 No. 20)

CPU Fan Connector

(4-pin CPU_FAN1)

(see p.11 No. 2)

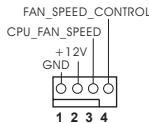

Please connect the CPU fan cable to the connector and match the black wire to the ground pin.

(3-pin CPU_FAN2)

(see p.11, No. 3)

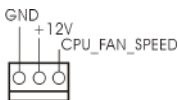



Though this motherboard provides 4-Pin CPU fan (Quiet Fan) support, the 3-Pin CPU fan still can work successfully even without the fan speed control function. If you plan to connect the 3-Pin CPU fan to the CPU fan connector on this motherboard, please connect it to Pin 1-3.

Pin 1-3 Connected ←

3-Pin Fan Installation



ATX Power Connector

(24-pin ATXPWR1)

(see p.11 No. 6)

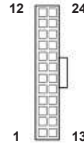

Please connect an ATX power supply to this connector.



Though this motherboard provides 24-pin ATX power connector, it can still work if you adopt a traditional 20-pin ATX power supply. To use the 20-pin ATX power supply, please plug your power supply along with Pin 1 and Pin 13.

20-Pin ATX Power Supply Installation



ATX 12V Power Connector

(8-pin ATX12V1)

(see p.11 No. 1)

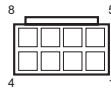

Please connect an ATX 12V power supply to this connector.



Though this motherboard provides 8-pin ATX 12V power connector, it can still work if you adopt a traditional 4-pin ATX 12V power supply. To use the 4-pin ATX power supply, please plug your power supply along with Pin 1 and Pin 5.

4-Pin ATX 12V Power Supply Installation



PCIe Power Connector

(4-pin PCIE_PWR1)

(see p.11, No. 22)



Please connect a 4 pin molex power cable to this connector when more than three graphics cards are installed.

Serial port Header

(9-pin COM1)

(see p.11 No. 18)

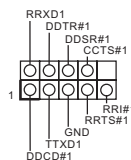

This COM1 header supports a serial port module.

2.7 CrossFireX™ and Quad CrossFireX™ Operation Guide

This motherboard supports CrossFireX™ and Quad CrossFireX™ that allows you to install up to two identical PCI Express x16 graphics cards. Currently CrossFireX™ and Quad CrossFireX™ are supported with Windows® 7 / 7 64-bit / 8 / 8 64-bit / 8.1 / 8.1 64-bit OS.



1. You should only use identical CrossFireX™-ready graphics cards that are AMD certified.
2. Make sure that your graphics card driver supports AMD CrossFireX™ technology. Download the drivers from the AMD's website: www.amd.com
3. Make sure that your power supply unit (PSU) can provide at least the minimum power your system requires. It is recommended to use a AMD certified PSU. Please refer to the AMD's website for details.
4. If you pair a 12-pipe CrossFireX™ Edition card with a 16-pipe card, both cards will operate as 12-pipe cards while in CrossFireX™ mode.
5. Different CrossFireX™ cards may require different methods to enable CrossFireX™. Please refer to AMD graphics card manuals for detailed installation guide.

2.7.1 Installing Two CrossFireX™-Ready Graphics Cards

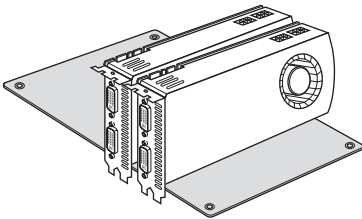

Step 1

Insert one graphics card into PCIE4 slot and the other graphics card to PCIE5 slot. Make sure that the cards are properly seated on the slots.



CrossFire Bridge

Step 2

Connect two graphics cards by installing a CrossFire Bridge on the CrossFire Bridge Interconnects on the top of the graphics cards. (The CrossFire Bridge is provided with the graphics card you purchase, not bundled with this motherboard. Please refer to your graphics card vendor for details.)

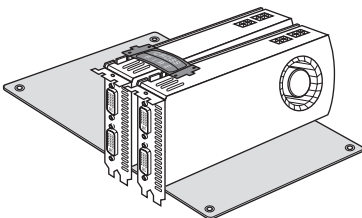

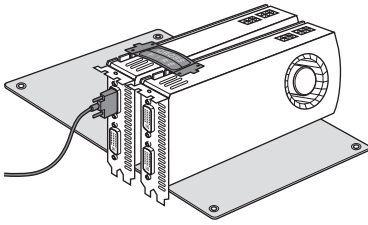

Step 3

Connect a VGA cable or a DVI cable to the monitor connector or the DVI connector of the graphics card that is inserted to PCIE4 slot.

2.7.2 Driver Installation and Setup

Step 1

Power on your computer and boot into OS.

Step 2

Remove the AMD drivers if you have any VGA drivers installed in your system.



The Catalyst Uninstaller is an optional download. We recommend using this utility to uninstall any previously installed Catalyst drivers prior to installation. Please check AMD's website for AMD driver updates.

Step 3

Install the required drivers and CATALYST Control Center then restart your computer. Please check AMD's website for details.



AMD Catalyst Control Center

Step 4

Double-click the **AMD Catalyst Control Center** icon in the Windows® system tray.



Step 5

In the left pane, click **Performance** and then **AMD CrossFireX™**. Then select **Enable AMD CrossFireX** and click **Apply**. Select the GPU number according to your graphics card and click **Apply**.

2.8 AMD Dual Graphics Operation Guide

This motherboard supports AMD Dual Graphics feature. AMD Dual Graphics brings multi-GPU performance capabilities by enabling an AMD A58 FCH (Bolton-D2) integrated graphics processor and a discrete graphics processor to operate simultaneously with combined output to a single display for blisteringly-fast frame rates. Currently, AMD Dual Graphics Technology is only supported with Windows® 8.1 / 8 / 7 OS.



What does an AMD Dual Graphics system include?

An AMD Dual Graphics system includes an AMD Radeon™ R7/R5 Series graphics processor and a motherboard based on an AMD A58 FCH (Bolton-D2) integrated chipset, all operating in a Windows® 8.1 / 8 / 7 environment. Please refer to AMD website for further information: <http://www.amd.com/us/products/technologies/dual-graphics/Pages/dual-graphics.aspx#3>

Enjoy the benefit of AMD Dual Graphics

- Step 1. Please keep the default UEFI setting of “Dual Graphics“ option on [Auto].
- Step 2. Install one AMD RADEON PCI Express graphics card to PCIE4 slot.
- Step 3. Connect the monitor cable to the onboard VGA port. Please be noted that the current VGA driver / VBIOS can allow Dual Graphics output from on-board display only. For any future update, please refer to our website for further information.
- Step 4. Boot into OS. Please remove the AMD driver if you have any VGA driver installed in your system.
- Step 5. Install the onboard VGA driver from our support CD to your system for both the onboard VGA and the discrete graphics card.
- Step 6. Restart your computer. Right-click the desktop. Click “AMD VISION Engine Control Center” to enter AMD VISION Engine Control Center.

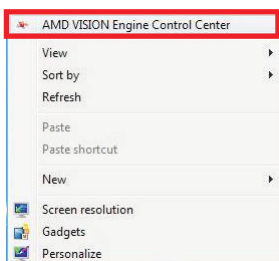

Step 7. You can also click “AMD VISION Engine Control Center” on your Windows® taskbar to enter AMD VISION Engine Control Center.

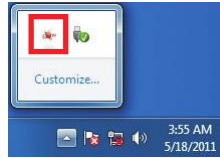

AMD VISION Engine Control Center

Step 8. In AMD VISION Engine Control Center, please choose “Performance”. Click “AMD CrossFire™”.

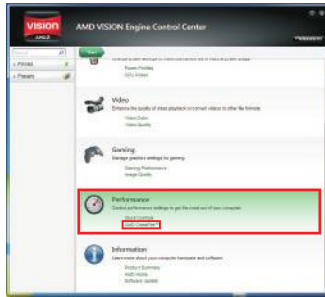

Step 9. Click “Enable CrossFire™” and click “Apply” to save your change.

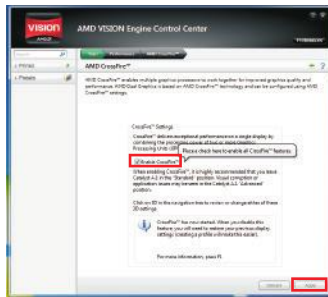

Step 10. Reboot your system. Then you can freely enjoy the benefit of Dual Graphics feature.

- * Dual Graphics appearing here is a registered trademark of AMD Technologies Inc., and is used only for identification or explanation and to the owners' benefit, without intent to infringe.
- * For further information of AMD Dual Graphics technology, please check AMD website for up dates and details.

3. Software and Utilities Operation

3.1 Installing Drivers

The Support CD that comes with the motherboard contains necessary drivers and useful utilities that enhance the motherboard's features.

Running The Support CD

To begin using the support CD, insert the CD into your CD-ROM drive. The CD automatically displays the Main Menu if "AUTORUN" is enabled in your computer. If the Main Menu does not appear automatically, locate and double click on the file "ASRSETUP.EXE" in the Support CD to display the menu.

Drivers Menu

The drivers compatible to your system will be auto-detected and listed on the support CD driver page. Please click Install All or follow the order from top to bottom to install those required drivers. Therefore, the drivers you install can work properly.

Utilities Menu

The Utilities Menu shows the application software that the motherboard supports. Click on a specific item then follow the installation wizard to install it.

3.2 A-Tuning

A-Tuning is ASRock's multi purpose software suite with a new interface, more new features and improved utilities, including XFast RAM, Dehumidifier, Good Night LED, FAN-Tastic Tuning, OC Tweaker and a whole lot more.

3.2.1 Installing A-Tuning

When you install the all-in-one driver to your system from ASRock's support CD, A-Tuning will be auto-installed as well. After the installation, you will find the icon "A-Tuning" on your desktop. Double-click the "A-Tuning"  icon, A-Tuning main menu will pop up.

3.2.2 Using A-Tuning

There are five sections in A-Tuning main menu: Operation Mode, Tools, OC Tweaker, System Info and Tech Service.

Operation Mode

Choose an operation mode for your computer.

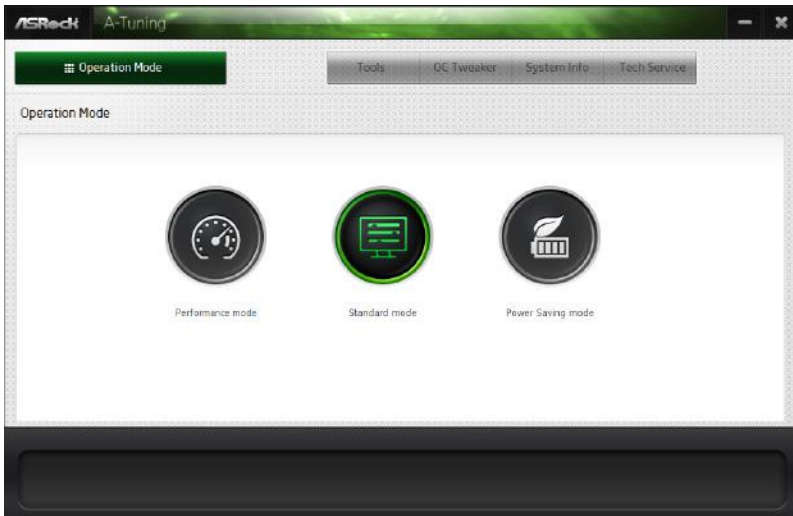

Tools

Various tools and utilities.

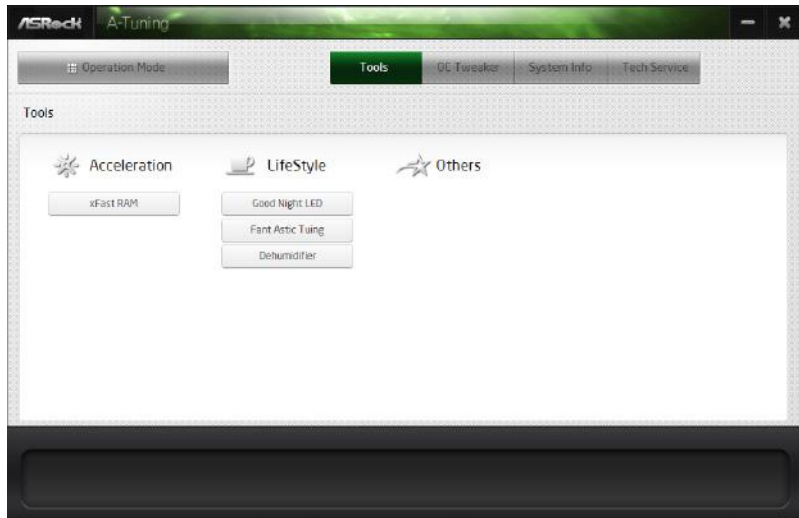

XFast RAM

Boost the system's performance and extend the HDD's or SSD's lifespan! Create a hidden partition, then assign which files should be stored in the RAM drive.

Fast Boot

Fast Boot minimizes your computer's boot time. Please note that Ultra Fast mode is only supported by Windows 8 and the VBIOS must support UEFI GOP if you are using an external graphics card.

OMG

Schedule the starting and ending hours of Internet access granted to other users. Place X marks on the time table to disable the Internet.

Good Night LED

Switch off the Power/HDD/LAN LEDs when the system is on, and automatically switch off the Power and Keyboard LEDs when the system enters into Standby/Hibernation mode.

FAN-Tastic Tuning

Configure up to five different fan speeds using the graph. The fans will automatically shift to the next speed level when the assigned temperature is met.

Dehumidifier

Prevent motherboard damages due to dampness. Enable this function and configure the period of time until the computer powers on, and the duration of the dehumidifying process.

OC Tweaker

Configurations for overclocking the system.



System Info

View information about the system.

System Browser

System Browser shows the overview of your current PC and the devices connected.

Tech Service

Contact Tech Service.

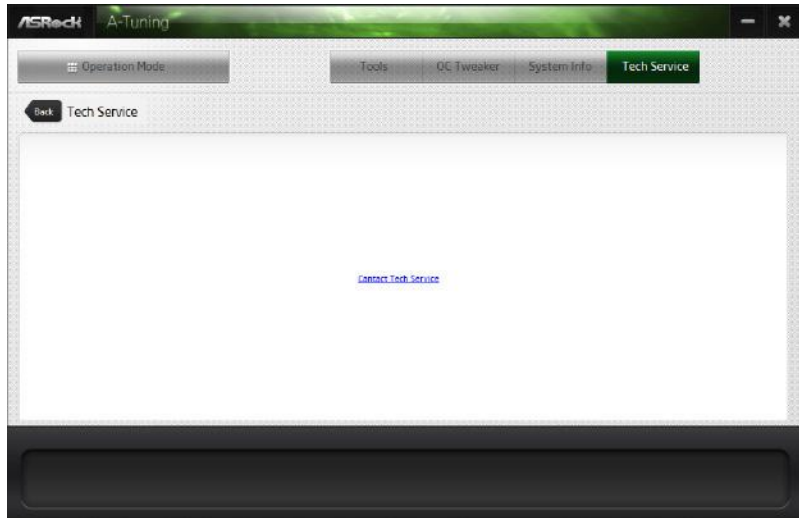

3.3 Start8

For those Windows 8 users who miss the Start Menu, Start8 is an ideal solution that brings back the familiar Start Menu along with added customizations for greater efficiency.

3.3.1 Installing Start8

Install Start8, which is located in the folder at the following path of the Support CD: \ ASRock Utility > Start8.

3.3.2 Configuring Start8

Style

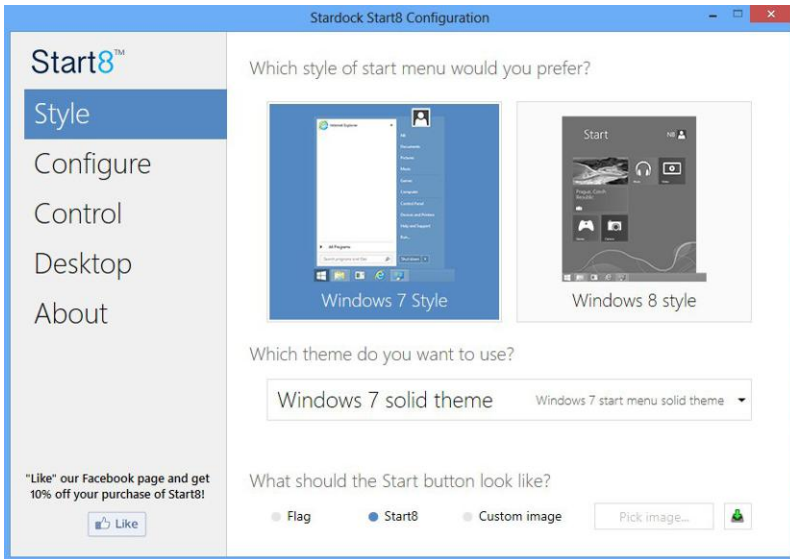

Select between the Windows 7 style and Windows 8 style Start Menu. Then select the theme of the Start Menu and customize the style of the Start icon.

Configure

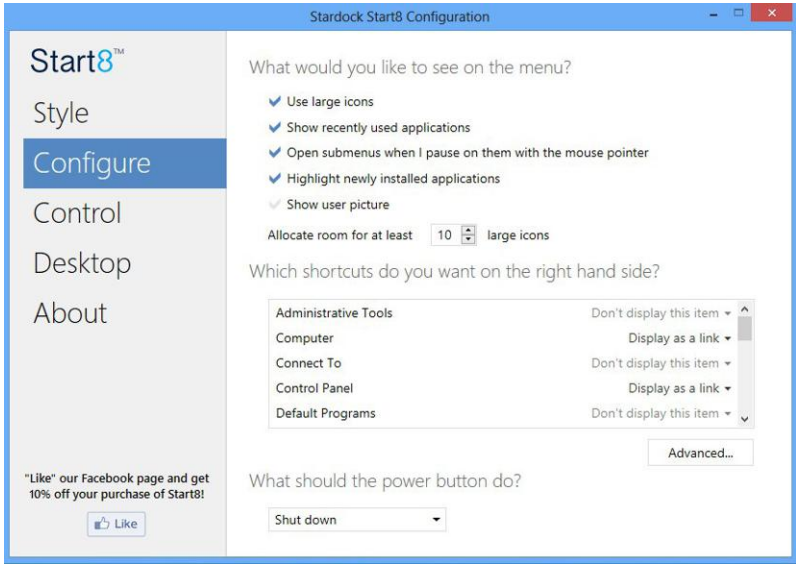

Configure provides configuration options, including icon sizes, which shortcuts you want Start Menu to display, quick access to recently used apps, the functionality of the power button, and more.

Control

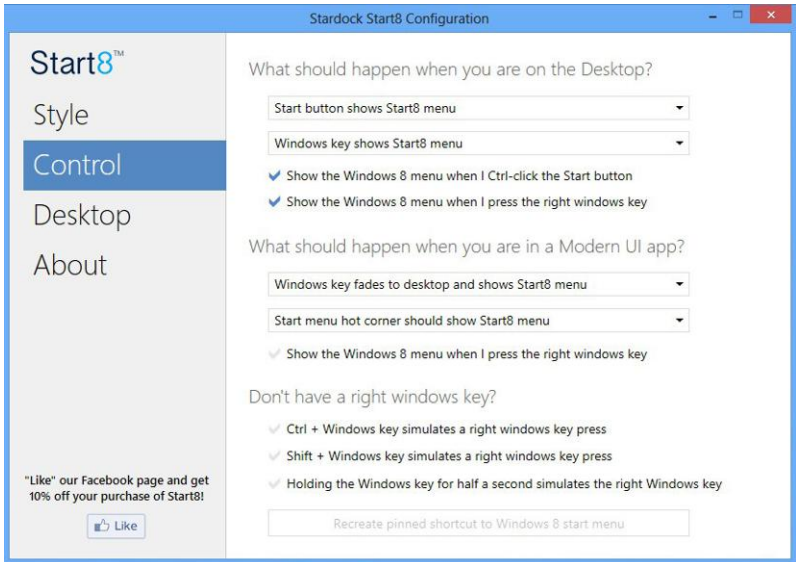

Control lets you configure what a click on the start button or a press on the Windows key does.

Desktop

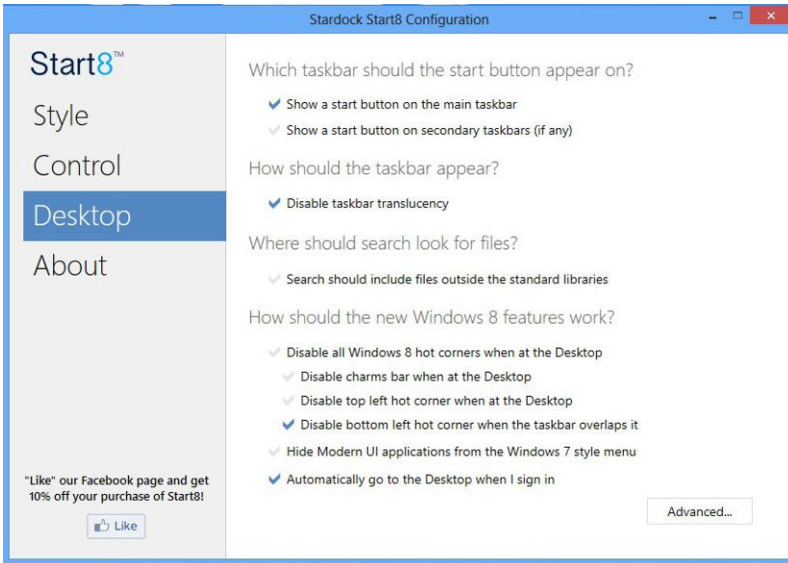

Desktop allows you to disable the hot corners when you are working on the desktop. It also lets you choose whether or not the system boots directly into desktop mode and bypass the Metro user interface.

About

Displays information about Start8.

4. UEFI SETUP UTILITY

4.1 Introduction

ASRock Interactive UEFI is a blend of system configuration tools, cool sound effects and stunning visuals. Not only will it make BIOS setup less difficult but also a lot more amusing. This section explains how to use the UEFI SETUP UTILITY to configure your system. The UEFI chip on the motherboard stores the UEFI SETUP UTILITY. You may run the UEFI SETUP UTILITY when you start up the computer. Please press <F2> or <Delete> during the Power-On-Self-Test (POST) to enter the UEFI SETUP UTILITY, otherwise, POST will continue with its test routines.

If you wish to enter the UEFI SETUP UTILITY after POST, restart the system by pressing <Ctl> + <Alt> + <Delete>, or by pressing the reset button on the system chassis. You may also restart by turning the system off and then back on.



Because the UEFI software is constantly being updated, the following UEFI setup screens and descriptions are for reference purpose only, and they may not exactly match what you see on your screen.

4.1.1 UEFI Menu Bar

The top of the screen has a menu bar with the following selections:

Main	For setting system time/date information
OC Tweaker	For overclocking configurations
Advanced	For advanced system configurations
Tool	Useful tools
H/W Monitor	Displays current hardware status
Boot	For configuring boot settings and boot priority
Security	For security settings
Exit	Exit the current screen or the UEFI SETUP UTILITY

Use < ← → > key or < → ← > key to choose among the selections on the menu bar, and use < ↑ > key or < ↓ > key to move the cursor up or down to select items, then press <Enter> to get into the sub screen. You can also navigate with a mouse.

4.1.2 Navigation Keys

Please check the following table for the function description of each navigation key.

Navigation Key(s)	Function Description
← / →	Moves cursor left or right to select Screens
↑ / ↓	Moves cursor up or down to select items
+ / -	To change option for the selected items
<Tab>	Switch to next function
<Enter>	To bring up the selected screen
<PGUP>	Go to the previous page
<PGDN>	Go to the next page
<HOME>	Go to the top of the screen
<END>	Go to the bottom of the screen
<F1>	To display the General Help Screen
<F7>	Discard changes and exit the UEFI SETUP UTILITY
<F9>	Load optimal default values for all the settings
<F10>	Save changes and exit the UEFI SETUP UTILITY
<F12>	Print screen
<ESC>	Jump to the Exit Screen or exit the current screen

4.2 Main Screen

When you enter the UEFI SETUP UTILITY, the Main screen will appear and display the system overview.



Active Page on Entry

This allows you to select the default page when entering UEFI setup utility.

4.3 OC Tweaker Screen

In the OC Tweaker screen, you can set up overclocking features.



CPU Configuration

Overclock Mode

Use this to select Overclock Mode. Configuration options: [Auto] and [Manual]. The default value is [Auto].

Spread Spectrum

This item should always be [Auto] for better system stability.

AMD Turbo Core Technology

This item appears only when the processor you adopt supports this feature. Use this to select enable or disable AMD Turbo Core Technology. Configuration options: [Enabled] and [Disabled]. The default value is [Enabled].

AMD Application power Management

Application Power Management (APM) ensures that average power consumption over a thermally significant time period remains at or below the TDP for the CPU mode being used. If [Enabled] is selected, the power consumption is reduced when overclocking.

Processor Maximum Frequency

It will display Processor Maximum Frequency for reference.

Processor Maximum Voltage

It will display Processor Maximum Voltage for reference.

Multiplier/Voltage Change

This item is set to [Auto] by default. If it is set to [Manual], you may adjust the value of Processor Frequency and Processor Voltage. However, it is recommended to keep the default value for system stability.

CPU Load-line Calibration

CPU Load-line Calibration helps prevent APU voltage droop when the system is under heavy load.

NB Load-line Calibration

NB Load-line Calibration helps prevent NB voltage droop when the system is under heavy load.

GFX Engine Clock

Use this to adjust GFX Engine Clock. The default value is [Auto].

DRAM Timing Configuration**Load XMP Setting**

Load XMP settings to overclock the DDR3 memory and perform beyond standard

DRAM Frequency

If [Auto] is selected, the motherboard will detect the memory module(s) inserted and assigns appropriate frequency automatically.

DRAM Timing Control



DRAM Slot

Use this item to view SPD data.

DRAM Timing Control

Use this item to control DRAM timing.

Power Down Enable

Use this item to enable or disable DDR power down mode.

Bank Interleaving

Interleaving allows memory accesses to be spread out over banks on the same node, or across nodes, decreasing access contention.

Channel Interleaving

It allows you to enable Channel Memory Interleaving. Configuration options: [Disabled], [Auto]. The default value is [Auto].

Voltage Configuration

DRAM Voltage

Use this to select DRAM Voltage. The default value is [Auto].

4.4 Advanced Screen

In this section, you may set the configurations for the following items: CPU Configuration, North Bridge Configuration, South Bridge Configuration, Storage Configuration, Super IO Configuration, ACPI Configuration and USB Configuration.



Setting wrong values in this section may cause the system to malfunction.

4.4.1 CPU Configuration



Core C6 Mode

Use this item to enable or disable Core C6 mode. The default value is [Enabled].

Cool 'n' Quiet

Use this item to enable or disable AMD's Cool 'n' Quiet™ technology. The default value is [Enabled]. Configuration options: [Enabled] and [Disabled]. If you install Windows® 8.1 / 8 / 7 and want to enable this function, please set this item to [Enabled]. Please note that enabling this function may reduce CPU voltage and memory frequency, and lead to system stability or compatibility issue with some memory modules or power supplies. Please set this item to [Disable] if above issue occurs.

SVM

When this option is set to [Enabled], a VMM (Virtual Machine Architecture) can utilize the additional hardware capabilities provided by AMD-V. The default value is [Enabled]. Configuration options: [Enabled] and [Disabled].

CPU Thermal Throttle

Use this item to enable CPU internal thermal control mechanism to keep the CPU from overheated. The default value is [Auto].

4.4.2 North Bridge Configuration



IOMMU

This allows you to enable or disable IOMMU support.

Primary Graphics Adapter

This item will switch the PCI Bus scanning order while searching for video card. It allows you to select the type of Primary VGA in case of multiple video controllers. The default value of this feature is [PCI Express]. Configuration options: [Onboard], [PCI] and [PCI Express].

Onboard Graphics

Select Enable/Disable/Auto for the onboard graphics.

Share Memory

This allows you to set the share memory feature. The default value is [Auto]. Configuration options: [Auto], [32MB], [64MB], [128MB], [256MB] [512MB], [1GB] and [2GB].

Onboard HDMI HD Audio

This allows you to enable or disable the “Onboard HDMI HD Audio” feature.

DVI Function

Use this to select DVI function when you install the DVI to HDMI adapter to DVI port. Configuration options: [as Dual Link DVI] and [as HDMI]. If you select [as Dual Link DVI], you can use Dual Link DVI monitor without audio function. If you select [as HDMI], you can use HDMI monitor with audio function. The default value is [as Dual Link DVI].

4.4.3 South Bridge Configuration



Onboard HD Audio

Select [Auto], [Enabled] or [Disabled] for the onboard HD Audio feature. If you select [Auto], the onboard HD Audio will be disabled when PCI Sound Card is plugged.

Front Panel

Select [Auto] or [Disabled] for the onboard HD Audio Front Panel.

Onboard LAN

This allows you to enable or disable the onboard LAN feature.

Good Night LED

Enable this option to turn off Power LED when the system is power on. The keyboard LED will also be turned off in S1, S3 and S4 state. The default value is [Auto].

4.4.4 Storage Configuration



SATA Controller

Use this item to enable or disable the “SATA Controller” feature.

SATA Mode

Use this item to adjust SATA Mode. The default value of this option is [AHCI Mode]. Configuration options: [AHCI Mode], [RAID Mode] and [IDE Mode].



If you set this item to RAID mode, it is suggested to install SATA ODD driver on SATA_5 and SATA_6 ports.

AMD AHCI BIOS ROM

Use this item to enable or disable AMD AHCI BIOS ROM. The default value of this option is [Disabled].

SATA IDE Combined Mode

This item is for SATA_5 and SATA_6.

Use this item to enable or disable SATA IDE combined mode. The default value is [Enabled].



If you want to build RAID on SATA_5 and SATA_6 ports, please disable this item.

Hard Disk S.M.A.R.T.

Use this item to enable or disable the S.M.A.R.T. (Self-Monitoring, Analysis, and Reporting Technology) feature. Configuration options: [Disabled], [Auto], [Enabled].

4.4.5 Super IO Configuration



Serial Port

Use this item to enable or disable the onboard serial port.

Serial Port Address

Use this item to set the address for the onboard serial port.
Configuration options: [3F8h / IRQ4] and [3E8h / IRQ4].

4.4.6 ACPI Configuration



Suspend to RAM

Use this item to select whether to auto-detect or disable the Suspend-to-RAM feature. Select [Auto] will enable this feature if the OS supports it.

Check Ready Bit

Enable to enter the operating system after S3 only when the hard disk is ready, this is recommended for better system stability.

Deep Sleep

Configure deep sleep mode for power saving when the computer is shut down. We recommend disabling Deep Sleep for better system compatibility and stability.

Restore on AC/Power Loss

This allows you to set the power state after an unexpected AC/power loss. If [Power Off] is selected, the AC/power remains off when the power recovers. If [Power On] is selected, the AC/power resumes and the system starts to boot up when the power recovers.

PS/2 Keyboard Power On

Use this item to enable or disable PS/2 keyboard to turn on the system from the power-soft-off mode.

PCI Devices Power On

Use this item to enable or disable PCI devices to turn on the system from the power-soft-off mode.

Ring-In Power On

Use this item to enable or disable Ring-In signals to turn on the system from the power-soft-off mode.

RTC Alarm Power On

Use this item to enable or disable RTC (Real Time Clock) to power on the system.

USB Keyboard/Remote Power On

Use this item to enable or disable USB Keyboard/Remote to power on the system.

USB Mouse Power On

Use this item to enable or disable USB Mouse to power on the system.

ACPI HPET table

Use this item to enable or disable ACPI HPET Table. The default value is [Enabled]. Please set this option to [Enabled] if you plan to use this motherboard to submit Windows® certification.

4.4.7 USB Configuration



USB Controller

Use this item to enable or disable the use of USB controller.

Legacy USB Support

Use this option to select legacy support for USB devices. There are four configuration options: [Enabled], [Auto], [Disabled] and [UEFI Setup Only]. The default value is [Enabled]. Please refer to below descriptions for the details of these four options:

[Enabled] - Enables support for legacy USB.

[Auto] - Enables legacy support if USB devices are connected.

[Disabled] - USB devices are not allowed to use under legacy OS and UEFI setup when [Disabled] is selected. If you have USB compatibility issue, it is recommended to select [Disabled] to enter OS.

[UEFI Setup Only] - USB devices are allowed to use only under UEFI setup and Windows / Linux OS.

4.5 Tool



System Browser

System Browser can let you easily check your current system configuration in UEFI setup.

OMG(Online Management Guard)

Administrators are able to establish an internet curfew or restrict internet access at specified times via OMG. You may schedule the starting and ending hours of internet access granted to other users. In order to prevent users from bypassing OMG, guest accounts without permission to modify the system time are required.

UEFI Tech Service

Contact ASRock Tech Service if you are having trouble with your PC. Please setup network configuration before using UEFI Tech Service.

Easy RAID Installer

Easy RAID Installer helps you to copy the RAID driver from the support CD to your USB storage device. After copying the drivers please change the SATA mode to RAID, then you can start installing the operating system in RAID mode.

Easy Driver Installer

For users that don't have an optical disk drive to install the drivers from our support CD, Easy Driver Installer is a handy tool in the UEFI that installs the LAN driver to your system via an USB storage device, then downloads and installs the other required drivers automatically.

UEFI Update Utility

Instant Flash

Instant Flash is a UEFI flash utility embedded in Flash ROM. This convenient UEFI update tool allows you to update system UEFI without entering operating systems first like MS-DOS or Windows®. Just save the new UEFI file to your USB flash drive, floppy disk or hard drive and launch this tool, then you can update your UEFI only in a few clicks without preparing an additional floppy diskette or other complicated flash utility. Please be noted that the USB flash drive or hard drive must use FAT32/16/12 file system. If you execute Instant Flash utility, the utility will show the UEFI files and their respective information. Select the proper UEFI file to update your UEFI, and reboot your system after the UEFI update process is completed.

Internet Flash

Internet Flash searches for available UEFI firmware updates from our servers. In other words, the system can auto-detect the latest UEFI from our servers and flash them without entering Windows OS.

Network Configuration



Internet Setting

Use this item to set up the internet connection mode. Configuration options: [DHCP (Auto IP)] and [PPPOE].

UEFI Download Server

Use this item to select UEFI firmware download server for Internet Flash. Configuration options: [Asia], [Europe], [USA] and [China].

Would you like to save current setting user defaults?

In this option, you are allowed to load and save three user defaults according to your own requirements.

Dehumidifier Function

Users may prevent motherboard damages due to dampness by enabling “Dehumidifier Function”. When enabling Dehumidifier Function, the computer will power on automatically to dehumidify the system after entering S4/S5 state.

Dehumidifier Period

This allows users to configure the period of time until the computer powers on and enables “Dehumidifier” after entering S4/S5 state.

Dehumidifier Duration

This allows users to configure the duration of the dehumidifying process before it returns to S4/S5 state.

Dehumidifier CPU Fan Setting

Use this setting to configure CPU fan speed while “Dehumidifier” is enabled.

Would you like to save current setting user defaults?

In this option, you are allowed to load and save three user defaults according to your own requirements.

4.6 Hardware Health Event Monitoring Screen

In this section, it allows you to monitor the status of the hardware on your system, including the parameters of the CPU temperature, motherboard temperature, CPU fan speed, chassis fan speed, and the critical voltage.



CPU Fan 1 Setting

This allows you to set the CPU fan 1 speed. Configuration options: [Full On] and [Automatic Mode]. The default is value [Full On].

Chassis Fan 1 Setting

This allows you to set the chassis fan 1 speed. Configuration options: [Full On], [Manual Mode] and [Automatic Mode]. The default is value [Full On].

Power Fan Setting

This allows you to set the power fan speed. Configuration options: [Full On] and [Manual Mode]. The default is value [Full On].

Chassis Fan 3 Setting

This allows you to set the chassis fan 3 speed. Configuration options: [Full On] and [Manual Mode]. The default is value [Full On].

Over Temperature Protection

Use this item to enable or disable Over Temperature Protection. The default value is [Enabled].

4.7 Boot Screen

In this section, it will display the available devices on your system for you to configure the boot settings and the boot priority.



Fast Boot

Fast Boot minimizes your computer's boot time. There are three configuration options: [Disabled], [Fast] and [Ultra Fast]. The default value is [Disabled]. Please refer to below descriptions for the details of these three options:

[Disabled] - Disable Fast Boot.

[Fast] - The only restriction is you may not boot by using an USB flash drive.

[Ultra Fast] - There are a few restrictions.

1. Only supports Windows® 8 UEFI operating system.
2. You will not be able to enter BIOS Setup (Clear CMOS or run utility in Windows® to enter BIOS Setup).
3. If you are using an external graphics card, the VBIOS must support UEFI GOP in order to boot.

Boot From Onboard LAN

Use this item to enable or disable the Boot From Onboard LAN feature.

Setup Prompt Timeout

This shows the number of seconds to wait for setup activation key.

Startup Num-Lock

If this item is set to [On], it will automatically activate the Numeric Lock function after boot-up.

Full Screen Logo

Use this item to enable or disable OEM Logo. The default value is [Enabled].

Option ROM Messages

[Force BIOS] - The third-party ROM messages will be forced to display during the bootsequence.

[Keep Current] - The third-party ROM messages will be displayed only if the third-party manufacturer had set the add-on device to do so.

Boot Failure Guard

Enable or disable the feature of Boot Failure Guard.

Boot Failure Guard Count

Enable or disable the feature of Boot Failure Guard Count.

CSM (Compatibility Support Module)



CSM

Enable to launch the Compatibility Support Module. Please do not disable unless you're running a WHCK test. If you are using Windows® 8 64-bit and all of your devices support UEFI, you may also disable CSM for faster boot speed.

Launch PXE OpROM Policy

Select UEFI only to run those that support UEFI option ROM only. Select Legacy only to run those that support legacy option ROM only. Do not launch?

Launch Storage OpROM Policy

Select UEFI only to run those that support UEFI option ROM only. Select Legacy only to run those that support legacy option ROM only. Do not launch?

Launch Video OpROM Policy

Select UEFI only to run those that support UEFI option ROM only. Select Legacy only to run those that support legacy option ROM only. Do not launch?

4.8 Security Screen

In this section, you may set or change the supervisor/user password for the system. For the user password, you may also clear it.



Secure Boot

Enable to support Windows® 8 Secure Boot.

4.9 Exit Screen



Save Changes and Exit

When you select this option, it will pop-out the following message, “Save configuration changes and exit setup?” Select [OK] to save the changes and exit the UEFI SETUP UTILITY.

Discard Changes and Exit

When you select this option, it will pop-out the following message, “Discard changes and exit setup?” Select [OK] to exit the UEFI SETUP UTILITY without saving any changes.

Discard Changes

When you select this option, it will pop-out the following message, “Discard changes?” Select [OK] to discard all changes.

Load UEFI Defaults

Load UEFI default values for all the setup questions. F9 key can be used for this operation.

Contact Information

If you need to contact ASRock or want to know more about ASRock, you're welcome to visit ASRock's website at <http://www.asrock.com>; or you may contact your dealer for further information. For technical questions, please submit a support request form at <http://www.asrock.com/support/tsd.asp>

ASRock Incorporation

2F., No.37, Sec. 2, Jhongyang S. Rd., Beitou District,
Taipei City 112, Taiwan (R.O.C.)

ASRock EUROPE B.V.

Bijsterhuizen 3151

6604 LV Wijchen

The Netherlands

Phone: +31-24-345-44-33

Fax: +31-24-345-44-38

ASRock America, Inc.

13848 Magnolia Ave, Chino, CA91710

U.S.A.

Phone: +1-909-590-8308

Fax: +1-909-590-1026