

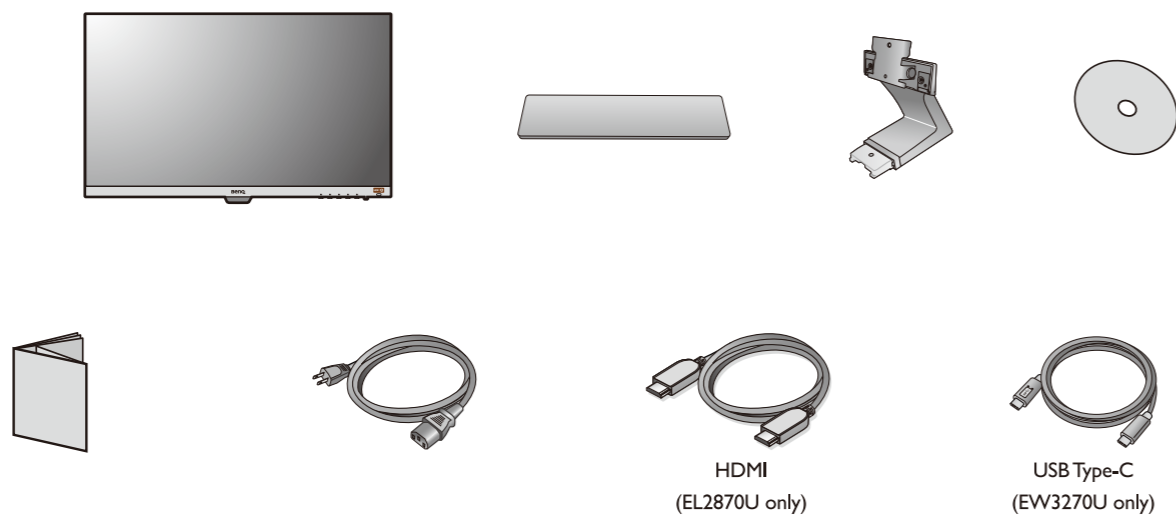

E70 Series LCD Monitor Quick Start Guide

DN: E70U-Q-V2

© 2017 BenQ Corporation. All rights reserved. Rights of modification reserved.

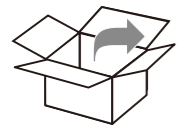
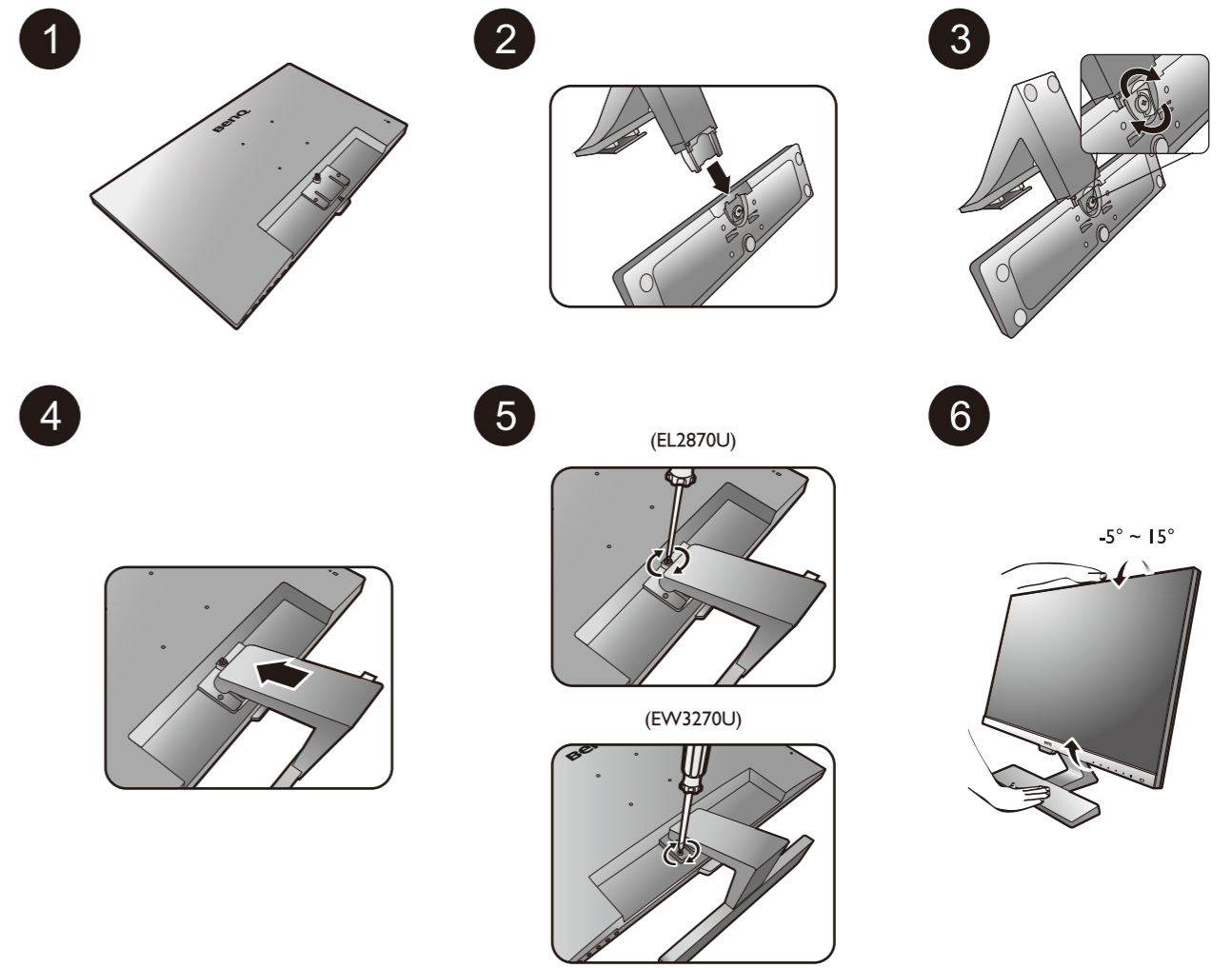

7 Video

8 Audio

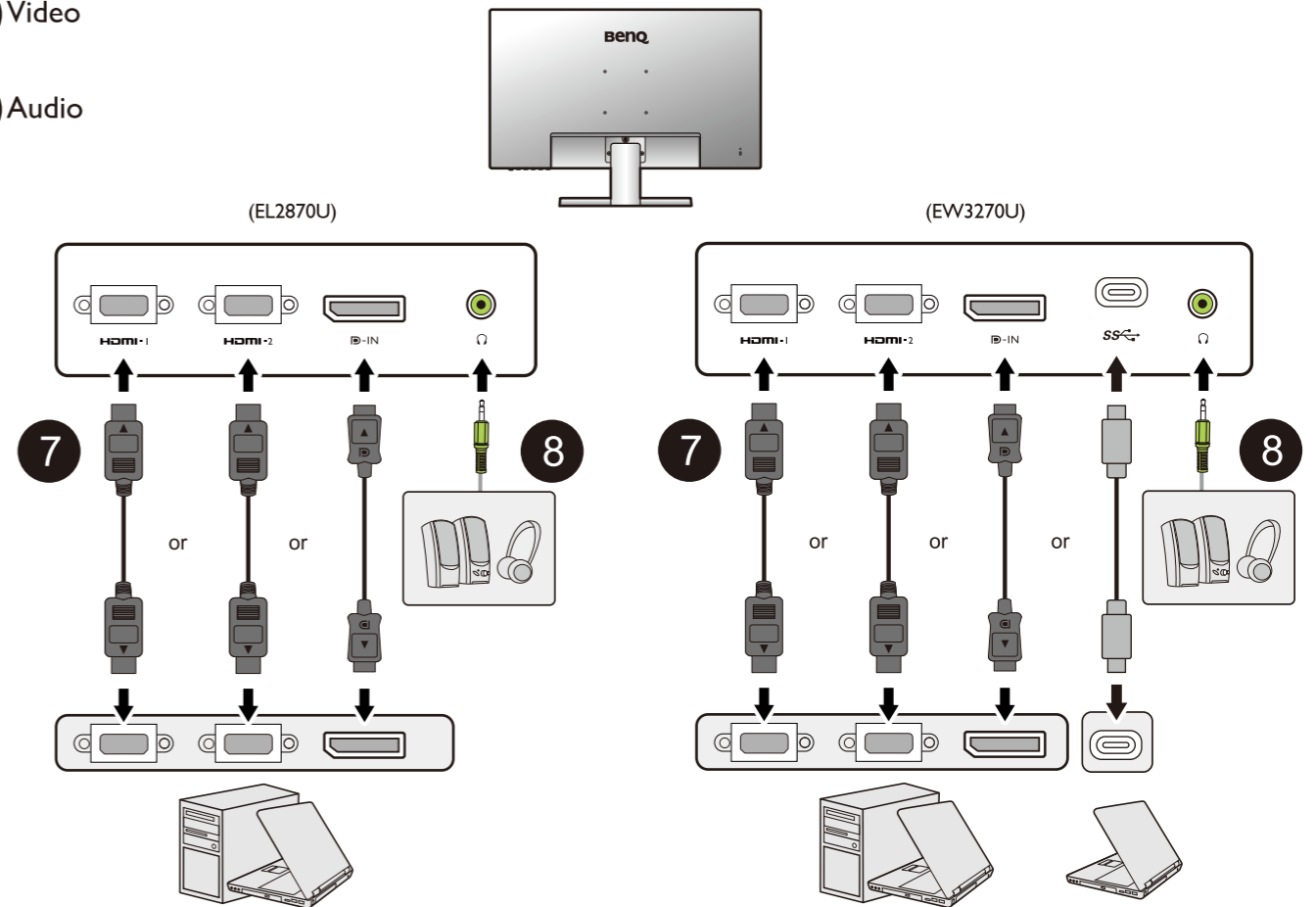

9

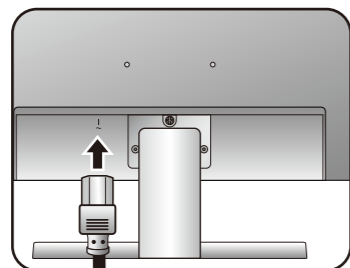

10

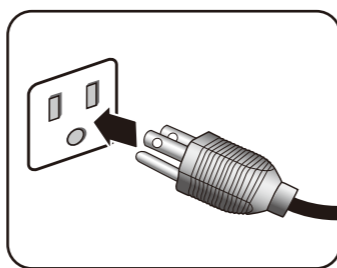

11

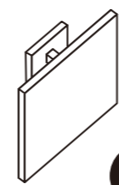
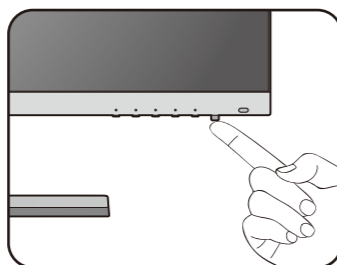

1

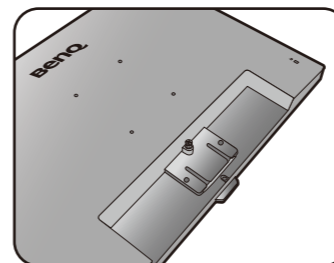

M4 x 10 mm

2

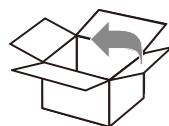
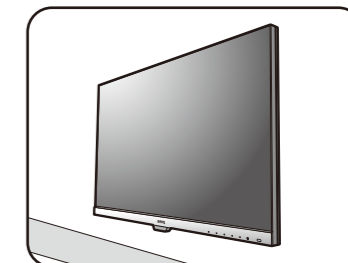

1

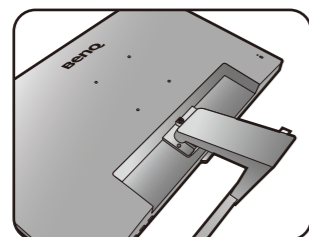

2

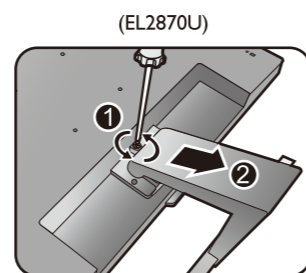

(EW3270U)

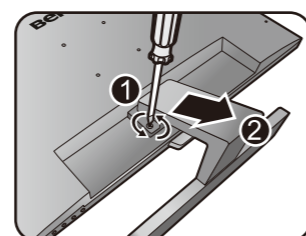

3

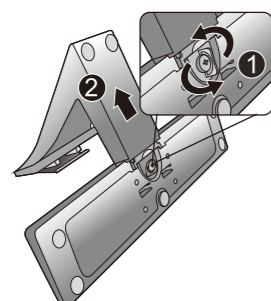

4

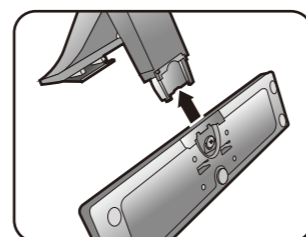

www.BenQ.com