

INTEL

AMD

INTEL LGA1851, LGA1700, LGA1200 & LGA115x

Dear customer,

Thank you very much for choosing the Noctua NH-L9x65 chromax.black.

The NH-L9x65 chromax.black is an all-black version of Noctua's award-winning NH-L9x65 premium-quality quiet CPU cooler.

I'm confident that you will be able to sense some of the research, attention and care we've put into making this cooler.

Enjoy your Noctua NH-L9x65 chromax.black!

Yours sincerely,

Roland Mossig, Noctua CEO

This manual will guide you through the installation process of the SecuFirm2™ mounting system step by step.

Prior to installing the cooler, please consult the compatibility centre on our website (ncc.noctua.at) and verify that the cooler is fully compatible with your motherboard, CPU, RAM and case. Please also make sure that there are no compatibility issues with any other components.

Double check that the heatsink and fan clips do not make contact with the VGA card, other PCIe cards, motherboard heatsinks or any other components.

Noctua cannot be held responsible for any damage or losses caused by compatibility issues.

Should you encounter any difficulties, please check the FAQs on our website (faqs.noctua.at) and don't hesitate to contact our support team at support@noctua.at.

Multilingual versions of this manual are available on our website: www.noctua.at/manuals

Required mounting parts:

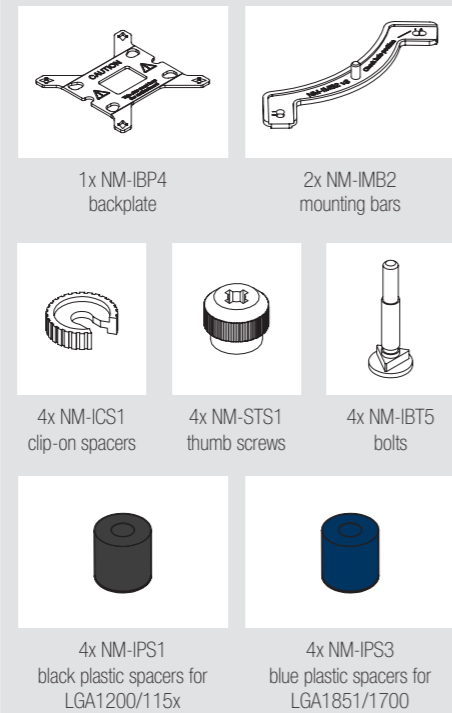

1 Removing the motherboard

If you would like to use the cooler on an assembled system and your case does not have a cut-out at the rear side of the motherboard tray, you must first remove the motherboard from the case in order to be able to install the supplied backplate.

2 Setting up the backplate

First, identify the side of the backplate that should face the motherboard (marked with caution signs). Then choose the appropriate hole spacing for your socket and insert the four bolts into the backplate from the opposite side (marked with model name, SecuFirm2™ branding and numbers for hole spacing) at the appropriate position.

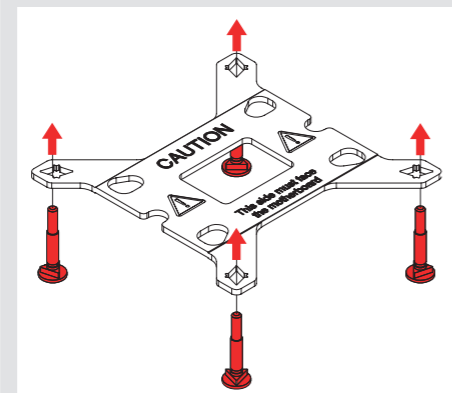

Use hole position 1 for LGA1200/LGA115x (LGA1150, LGA1151, LGA1155, LGA1156) and hole position 2 for LGA1851/LGA1700:



Fix the bolts using the NM-ICS1 clip-on spacers.

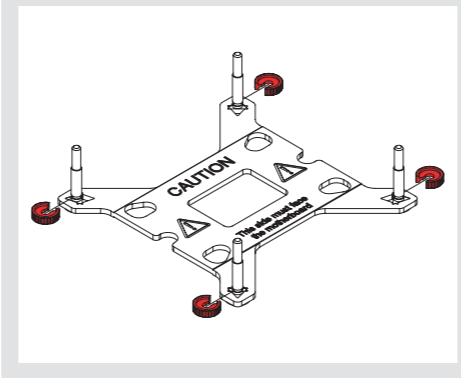

3 Attaching the backplate

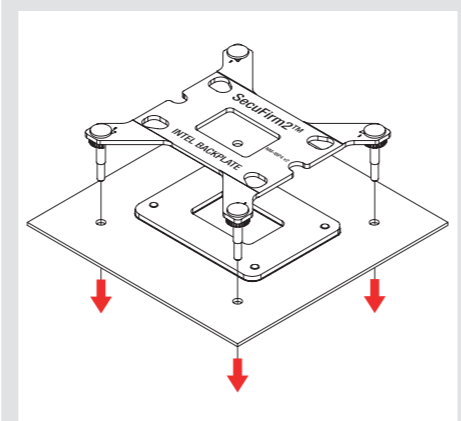

Caution: The supplied backplate will install over the motherboard's stock backplate, so the motherboard's stock backplate must not be taken off.

Place the backplate on the rear side of the motherboard so that the bolts protrude through the mounting holes.

4 Installing the mounting bars

Please first choose the correct set of plastic spacers and the correct set of holes on the mounting bars according to whether you are using an LGA1200/LGA115x (LGA1150, LGA1151, LGA1155, LGA1156) or an LGA1851/LGA1700 socket motherboard.

Use the black NM-IPS1 plastic spacers for LGA1200/LGA115x (LGA1150, LGA1151, LGA1155, LGA1156) and the blue NM-IPS3 spacers for LGA1851/LGA1700.

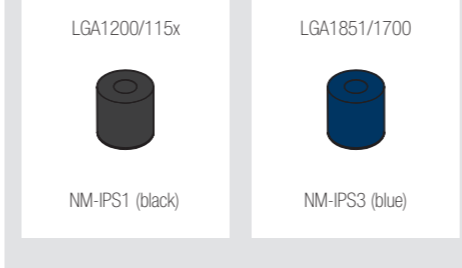

Use hole position 1 for LGA1200/LGA115x (LGA1150, LGA1151, LGA1155, LGA1156) and hole position 2 for LGA1851/LGA1700:



Put the plastic spacers onto the bolts of the backplate, then add the mounting bars.

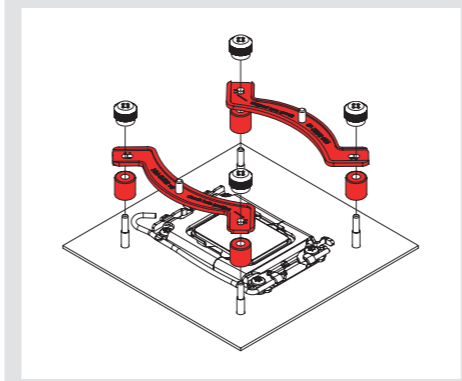

Caution: Choose the alignment of the mounting bars according to the desired final orientation of the cooler.

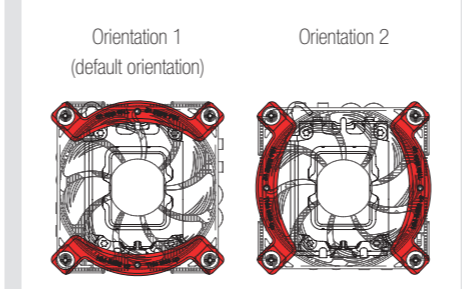

Caution: Make sure that the curved sides of the mounting bars are pointing outwards.

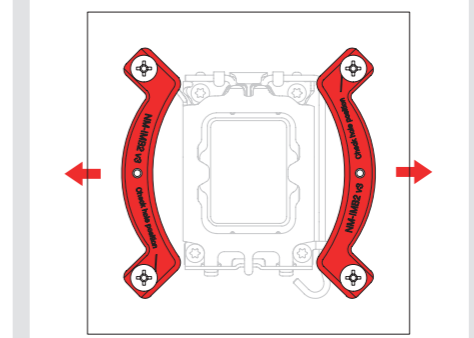

Fix the mounting bars using the four NM-ST51 thumb screws.

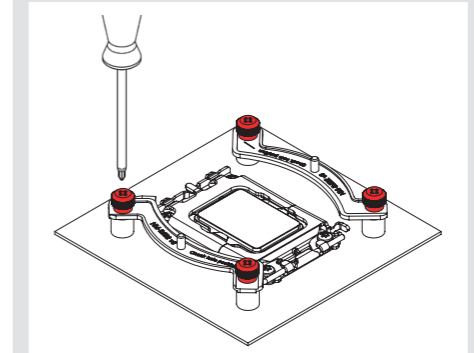

Caution: Gently tighten the screws until they stop, but do not use excessive force (max. torque 0.6 Nm).

5 Applying the thermal paste

If there are residual traces of thermal paste or thermal pads on your CPU, please clean them off first. Then apply the supplied NT-H1 thermal paste onto the CPU as shown in the following images.

For LGA1851/LGA1700, apply 5 small dots; 4 dots with ~2mm diameter near the corners plus 1 dot with 3-4mm diameter in the centre:

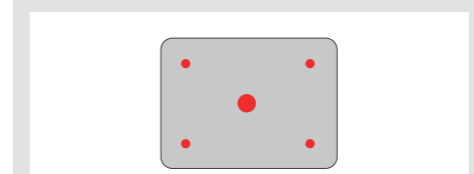

For LGA1200/LGA115x (LGA1150, LGA1151, LGA1155, LGA1156) apply a single 4-5mm dot in the centre:

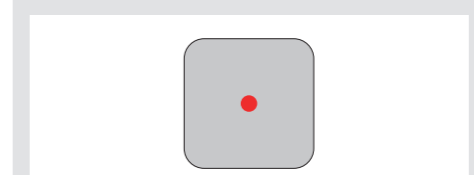

Caution: Applying too much thermal paste will lower heat conductivity and cooling performance!

6 Fastening the heatsink to the CPU

Caution: Please first take off the protection cover at the bottom side of the heatsink.

Then put the heatsink onto the CPU and screw it to the screw threads of the mounting bars. Perform 2-3 turns on each screw, then repeat until both are fully tightened. Note that you can reach through the blades of the fan using the supplied screw driver. There is thus no need to take off the fan for installation.

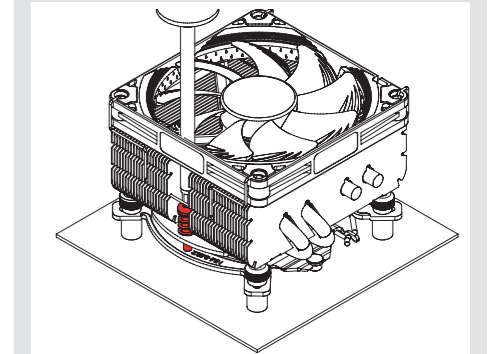

Caution: Gently tighten the screws until they stop, but do not use excessive force (max. torque 0.6 Nm).

Connect the fan to the motherboard's CPU fan header. Depending on your CPU and the temperature inside the case, you may interconnect the supplied NA-RC7 Low-Noise Adaptor (L.N.A.) in order to further reduce the fans' operating noise.

Caution: When using the L.N.A., check the temperature of your CPU using appropriate software (e.g. the respective applications of your motherboard manufacturer), in order to evade automatic throttling of the CPU due to the increased temperature. If the cooling performance is insufficient, please increase case ventilation or remove the L.N.A.

! Transporting your system

Due to the low weight of the cooler, it is not necessary to take it off for transport.

! Warranty, support and FAQs

Even with high-grade products and strict quality control, the possibility of defects cannot be eliminated entirely. Therefore, we aim at providing the highest possible level of reliability and convenience by offering a warranty period of 6 years and direct, fast and straightforward RMA service.

Should you encounter any problems with your NH-L9x65 chromax.black, please don't hesitate to contact our support team (support@noctua.at).

Please also consult the FAQ section on our website: faqs.noctua.at



AMD AM5 & AM4

Required mounting parts:

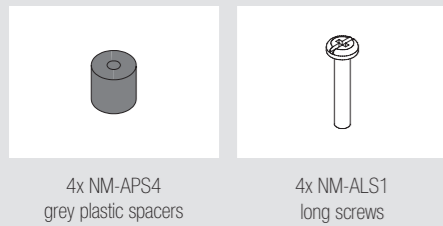
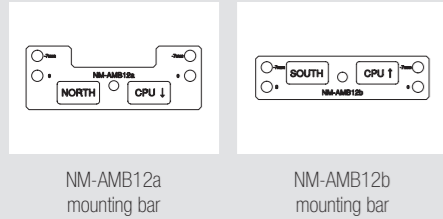
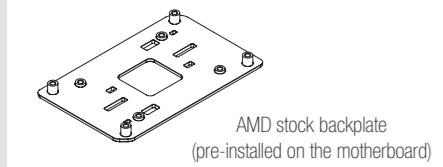

1 Removing the stock retention module – putting the backplate in place

The SecuFirm2™ mounting system will install directly to the motherboard's stock backplate, so please first remove the motherboard's stock CPU cooler retention module by unscrewing it from the backplate (if it has not already been removed for previous installations).

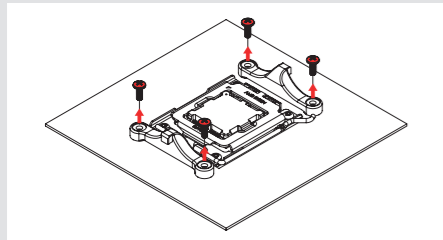

On AM4, the stock backplate will become loose when unscrewing the retention module, so hold it in place for the next step. If you have lost your stock AM4 backplate, please contact us at support@noctua.at. On AM5, the stock backplate is screw-fixed to the socket, so should simply remain in place.

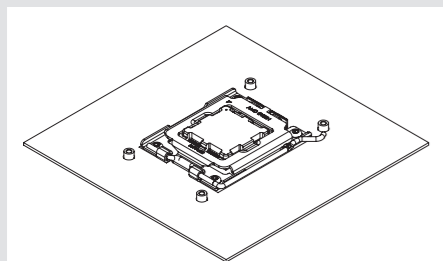

2 Installing the mounting bars

First put the plastic spacers onto the screw threads of the backplate. Then fix the NM-AMB12 mounting bars using the four NM-ALS1 long screws.

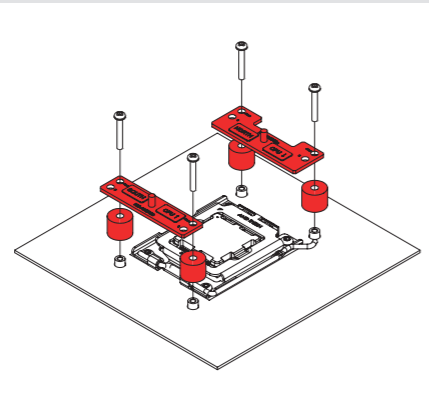

On AM5 and Ryzen 5000/3000 series AM4 CPUs, choose the -7mm offset hole position to ensure optimal contact quality and performance.

On other AM4 CPUs, or if there are any compatibility issues in the offset position (e.g. clearance with motherboard heatsinks), please choose the standard position (0).

Offset position



Standard position (no offset)

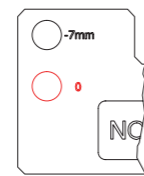

Offset position

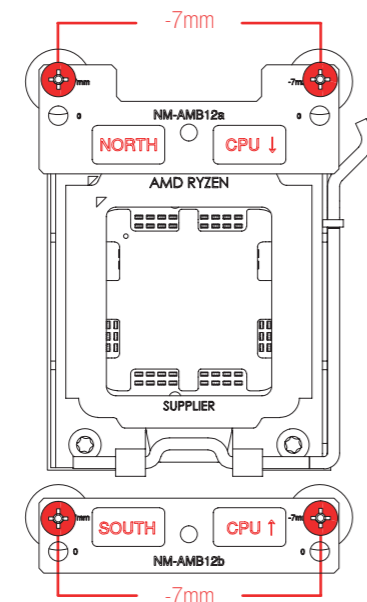

! Transporting your system

Due to the low weight of the cooler, it is not necessary to take it off for transport.

! Warranty, support and FAQs

Even with high-grade products and strict quality control, the possibility of defects cannot be eliminated entirely. Therefore, we aim at providing the highest possible level of reliability and convenience by offering a warranty period of 6 years and direct, fast and straightforward RMA service.

Should you encounter any problems with your NH-L9x65 chromax.black, please don't hesitate to contact our support team (support@noctua.at).

Please also consult the FAQ section on our website: [faq.noctua.at](https://www.noctua.at/faq)

Standard position (no offset)

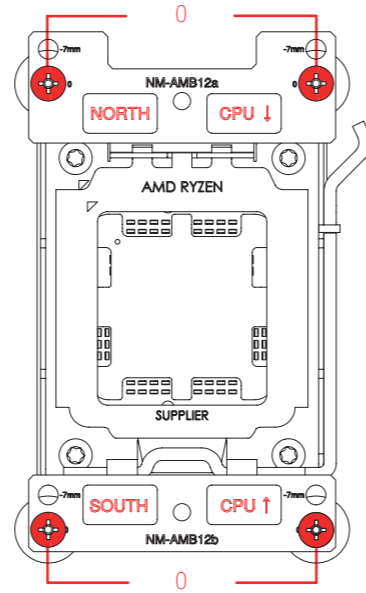

Caution: Make sure that the "CPU →" markings point towards the CPU and that the NM-AMB12a bar with the "NORTH" marking is installed on the north (top) side of the socket and the NM-AMB12b bar with the "SOUTH" marking is installed on the south (bottom) side of the socket, as shown above.

Gently tighten the screws until they stop, but do not use excessive force (max. torque 0.6 Nm).

3 Applying the thermal paste

If there are residual traces of thermal paste or thermal pads on your CPU, please clean them off first.

Then, apply 5 dots of the supplied NT-H1 thermal paste; 4 small dots with ~2mm diameter near the corners plus 1 dot with 3-4mm diameter in the centre:

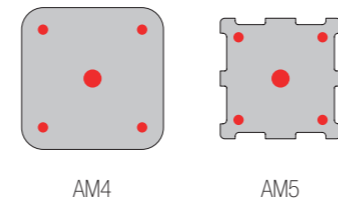

Caution: Applying too much thermal paste will lower heat conductivity and cooling performance!

4 Fastening the heatsink to the CPU

Please refer to step 6 of the Intel installation manual.