

Contents

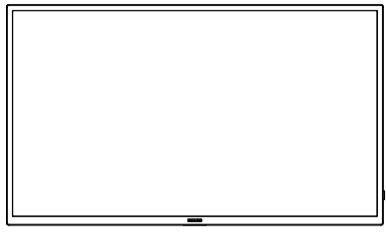

LCD display

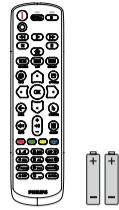

Remote Control and AAA Batteries



Quick start guide



Power Cord

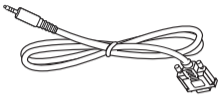

RS232 Cable

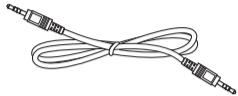

RS232 Daisy Chain Cable



IR Sensor Cable

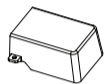

USB Cover



Cable Clip x 2PCS



Philips logo plate

* Differences according to regions.
Display design and accessories may differ from those illustrated above.



1 Unboxing

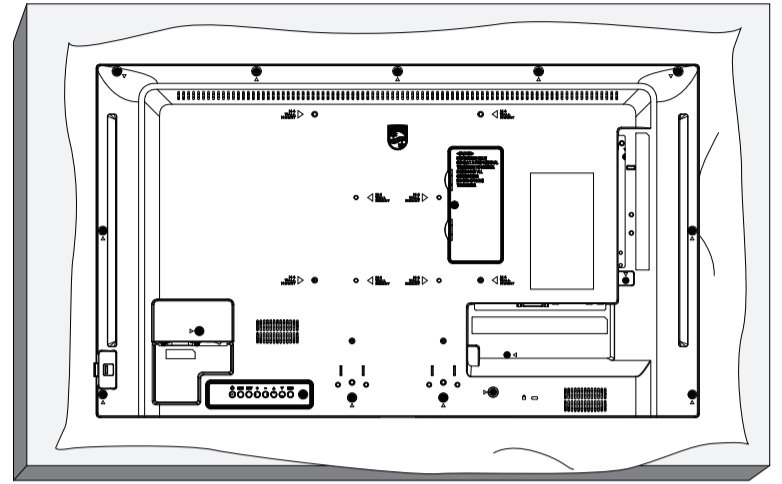

2 Input/Output Terminals

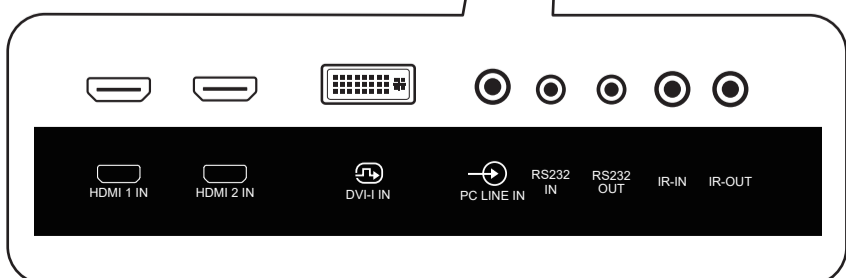
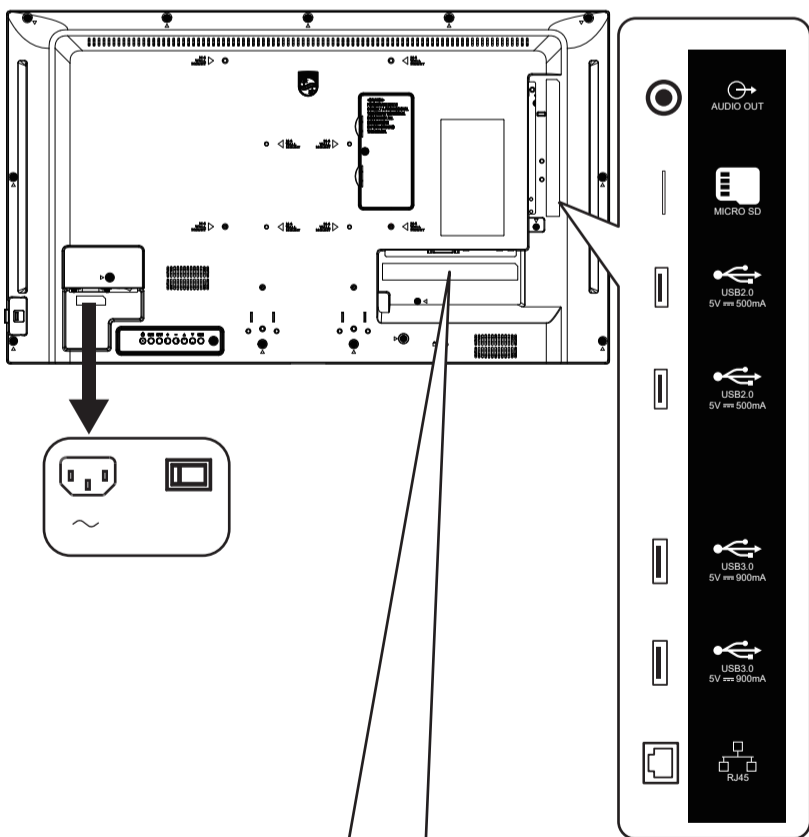

3 Connection

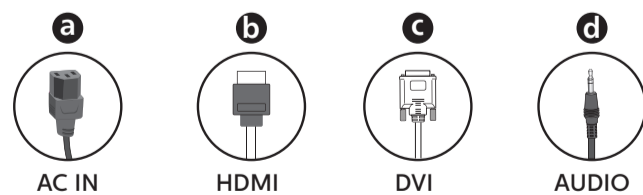
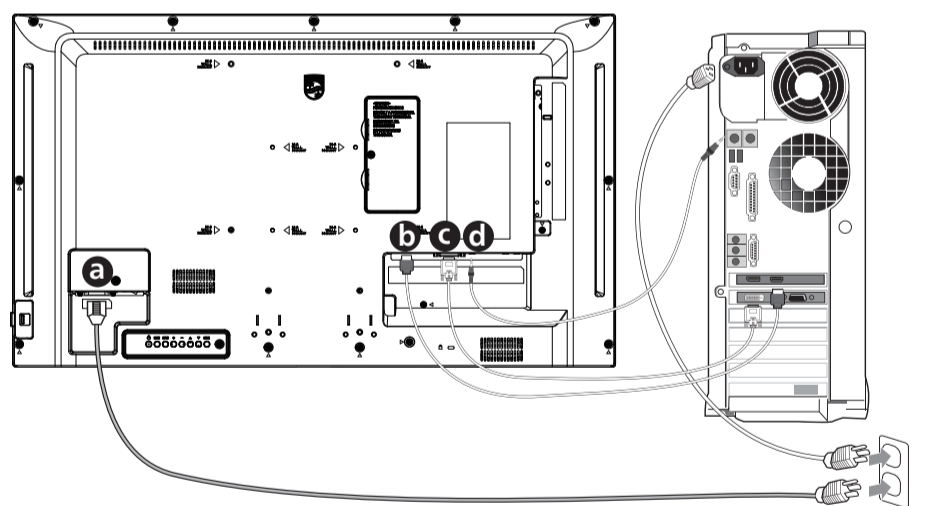

4 Control Panel

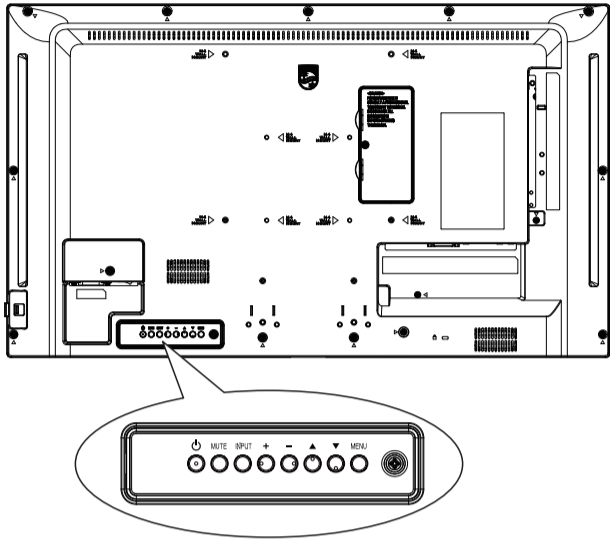

PHILIPS

Professional
Display Solutions

Q Line

32BDL3650Q

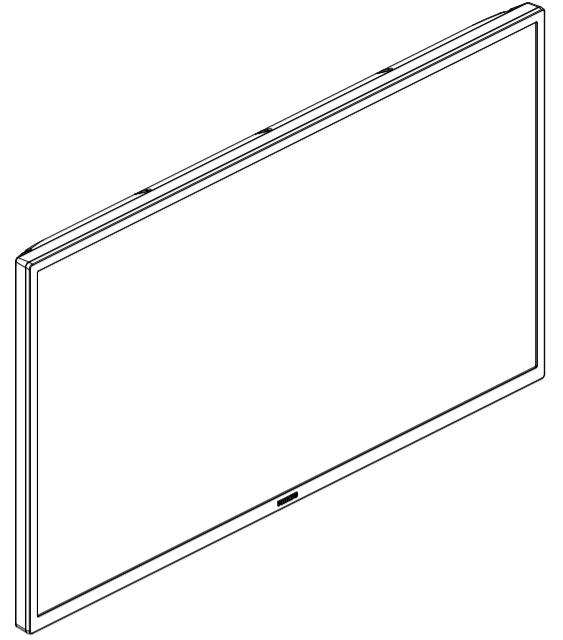



Quick start

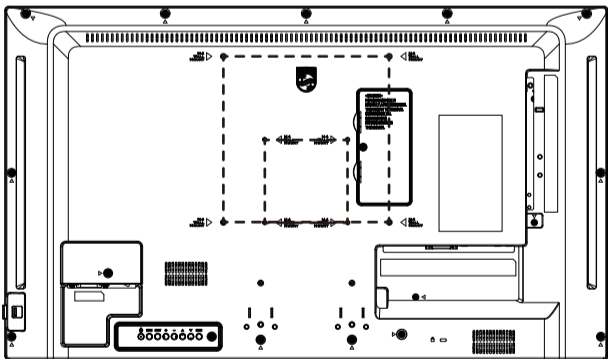
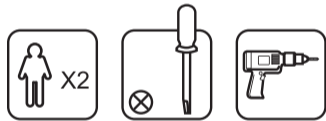

For more information, please visit:
<https://www.philips.com/ppds>

5 Installation



 M4 * (10+X) mm
(X=Thickness of Wall mount BKT)
32BDL3650Q: 100mm x 100mm
200mm x 200mm



Version: V1.00 2023-01-11

TPV USA Corp
6525 Carnegie Blvd #200
Charlotte, NC 28211
USA

2023 © TOP Victory Investments Ltd. All rights reserved.

This product has been manufactured by and is sold under the responsibility of Top Victory Investments Ltd., and Top Victory Investments Ltd. is the warrantor in relation to this product. Philips and the Philips Shield Emblem are registered trademarks of Koninklijke Philips N.V. and are used under license.

Specifications are subject to change without notice.



Q41G32M281302A