



FCC Information and Copyright

This equipment has been tested and found to comply with the limits of a Class B digital device, pursuant to Part 15 of the FCC Rules. These limits are designed to provide reasonable protection against harmful interference in a residential installation. This equipment generates, uses, and can radiate radio frequency energy and, if not installed and used in accordance with the instructions, may cause harmful interference to radio communications. There is no guarantee that interference will not occur in a particular installation.

The vendor makes no representations or warranties with respect to the contents here and specially disclaims any implied warranties of merchantability or fitness for any purpose. Further the vendor reserves the right to revise this publication and to make changes to the contents here without obligation to notify any party beforehand.

Duplication of this publication, in part or in whole, is not allowed without first obtaining the vendor's approval in writing.

The content of this user's manual is subject to be changed without notice and we will not be responsible for any mistakes found in this user's manual. All the brand and product names are trademarks of their respective companies.



Dichiarazione di conformità sintetica
Ai sensi dell'art. 2 comma 3 del D.M. 275 del
30/10/2002

Si dichiara che questo prodotto è conforme
alle normative vigenti e soddisfa i requisiti
essenziali richiesti dalle direttive
2004/108/CE, 2006/95/CE e 1999/05/CE
quando ad esso applicabili

Short Declaration of conformity

We declare this product is complying with the
laws in force and meeting all the essential
requirements as specified by the directives
2004/108/CE, 2006/95/CE and 1999/05/CE
whenever these laws may be applied

Table Of Contents

FCC Information and Copyright	1
Chapter 1: Introduction.....	3
1.1 Before You Start	3
1.2 Package Checklist.....	3
1.3 Specifications.....	4
1.4 Rear Panel Connectors.....	5
1.5 Motherboard Layout	6
Chapter 2: Hardware Installation.....	9
2.1 Install Central Processing Unit (CPU)	9
2.2 Install a Heatsink.....	11
2.3 Connect Cooling Fans	12
2.4 Install System Memory	12
2.5 Expansion Slots.....	14
2.6 Jumper & Switch Setting.....	15
2.7 Headers & Connectors.....	16
Chapter 3: UEFI BIOS & Software.....	20
3.1 UEFI BIOS Setup.....	20
3.2 BIOS Update.....	20
3.3 Software.....	24
Chapter 4: Useful Help	27
4.1 Driver Installation	27
4.2 AMI BIOS Beep Code.....	28
4.3 AMI BIOS post code	28
4.4 Troubleshooting.....	30
APPENDIX I: Specifications in Other Languages	31
Arabic.....	31
German.....	32
Russian.....	33
Spanish	34
Thai.....	35

Chapter 1: Introduction

1.1 Before You Start

Thank you for choosing our product. Before you start installing the motherboard, please make sure you follow the instructions below:

- Prepare a dry and stable working environment with sufficient lighting.
- Always disconnect the computer from power outlet before operation.
- Before you take the motherboard out from anti-static bag, ground yourself properly by touching any safely grounded appliance, or use grounded wrist strap to remove the static charge.
- Avoid touching the components on motherboard or the rear side of the board unless necessary. Hold the board on the edge, do not try to bend or flex the board.
- Do not leave any unfastened small parts inside the case after installation. Loose parts will cause short circuits which may damage the equipment.
- Keep the computer from dangerous area, such as heat source, humid air and water.
- The operating temperatures of the computer should be 0 to 45 degrees Celsius.
- To avoid injury, be careful of:
 - Sharp pins on headers and connectors
 - Rough edges and sharp corners on the chassis
 - Damage to wires that could cause a short circuit

1.2 Package Checklist

- Serial ATA Cable x2
- Rear I/O Panel for ATX Case x1
- User's Manual x1
- Fully Setup Driver DVD x1

Note

- » *The package contents may be different due to the sales region or models in which it was sold. For more information about the standard package in your region, please contact your dealer or sales representative.*
-

1.3 Specifications

Specifications			
CPU Support	Socket 1151 for 8th Intel® Core i7 / i5 / i3 / Pentium / Celeron processor Maximum CPU TDP (Thermal Design Power): 95Watt * 8th Generation Intel® Core™ Processor Family only support 300-Series. * Please refer to www.biostar.com.tw for CPU support list.		
Chipset	TB360-BTC PRO & TB360-BTC+ : INTEL® B360 TB360-BTC Expert: INTEL® H370		
Memory	Supports Dual Channel DDR4 1866/ 2133/ 2400/ 2666 2x DDR4 DIMM Memory Slot, Max. Supports up to 32 GB Memory Each DIMM supports non-ECC 4/8/16GB DDR4 module * Please refer to www.biostar.com.tw for Memory support list.		
Storage	4x SATA III Connector (6Gb/s) 1x M.2 (6Gb/s): Support SATA SSD		
LAN	RTL8111H 10/ 100/ 1000 Mb/s auto negotiation, Half / Full duplex capability		
Audio Codec	ALC887 7.1 Channels, High Definition Audio		
USB	6x USB 3.1(Gen1) port (4 on rear I/Os and 2 via internal header) 6x USB 2.0 port (2 on rear I/Os and 4 via internal header)		
Expansion Slots	TB360-BTC PRO:	TB360-BTC+ :	TB360-BTC Expert:
	11x PCIe 3.0 x1 Slot 1x PCIe 3.0 x16 Slot	7x PCIe 3.0 x1 Slot 1x PCIe 3.0 x16 Slot	16x PCIe 3.0 x1 Slot 1x PCIe 3.0 x16 Slot
* Maximum VGA cards mining support are depending on VGA Driver or mining software.			
Rear I/Os	1x PS/2 Mouse 1x PS/2 Keyboard 1x VGA Port 1x HDMI Port 1x LAN port 2x USB 2.0 Port 4x USB 3.1(Gen1) Port 3x Audio Jack		
Internal I/Os	4x SATA III Connector (6Gb/s) 2x USB 2.0 Header (each header supports 2 USB 2.0 ports) 1x USB 3.1(Gen1) Header (each header supports 2 USB 3.1(Gen1) ports) 1x 8-Pin Power Connector 2x 24-Pin Power Connector 2 x 6-Pin PCIe Power Connector 1x CPU Fan Connector 2x System Fan Connector 1x Front Panel Header 1x Front Audio Header 1x COM Serial Header 1x Clear CMOS Header		
Form Factor	ATX Form Factor, 305mm x 210mm		
OS Support	Windows 10(64bit) * Biostar reserves the right to add or remove support for any OS with or without notice.		

1.4 Rear Panel Connectors

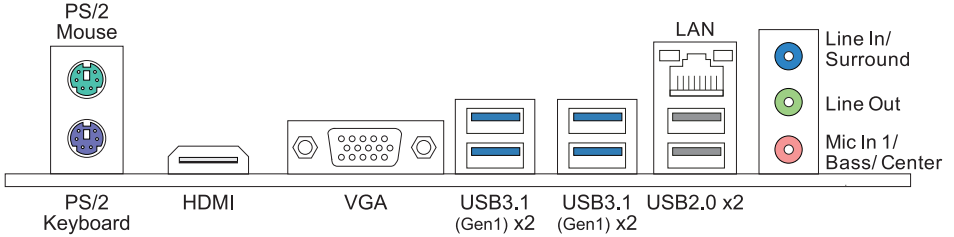

Note

- » VGA / HDMI port only works with an Intel® integrated Graphics Processor.
- » Maximum resolution
VGA: 1920 x 1200 @60Hz
HDMI: 4096 x 2160 @24Hz, compliant with HDMI 1.4
- » When using the front HD audio jack and plug in the headset, the rear sound will be automatically Disabled.
- » To configure 7.1-channel audio, you have to use a chassis with HD front panel audio module and enable the multi-channel audio feature through O.S. Audio Utility.
- » The mainboard supports two onboard display outputs at same time and the display output configuration can be selected in Intel graphics driver utility.

The 2/ 4/ 5.1/ 7.1-channel configuration

Audio Port	2-channel	4-channel	5.1 channel	7.1 channel
Blue (Rear Panel)	Line In	Line In	Line In	Side Speaker Out
Green (Rear Panel)	Line Out	Front Speaker Out	Front Speaker Out	Front Speaker Out
Pink (Rear Panel)	Mic In	Mic In	Center/Subwoofer Out	Center/Subwoofer Out
Green (Front Panel)	Headphone	Rear Speaker Out	Rear Speaker Out	Rear Speaker Out

1.5 Motherboard Layout

TB360-BTC PRO

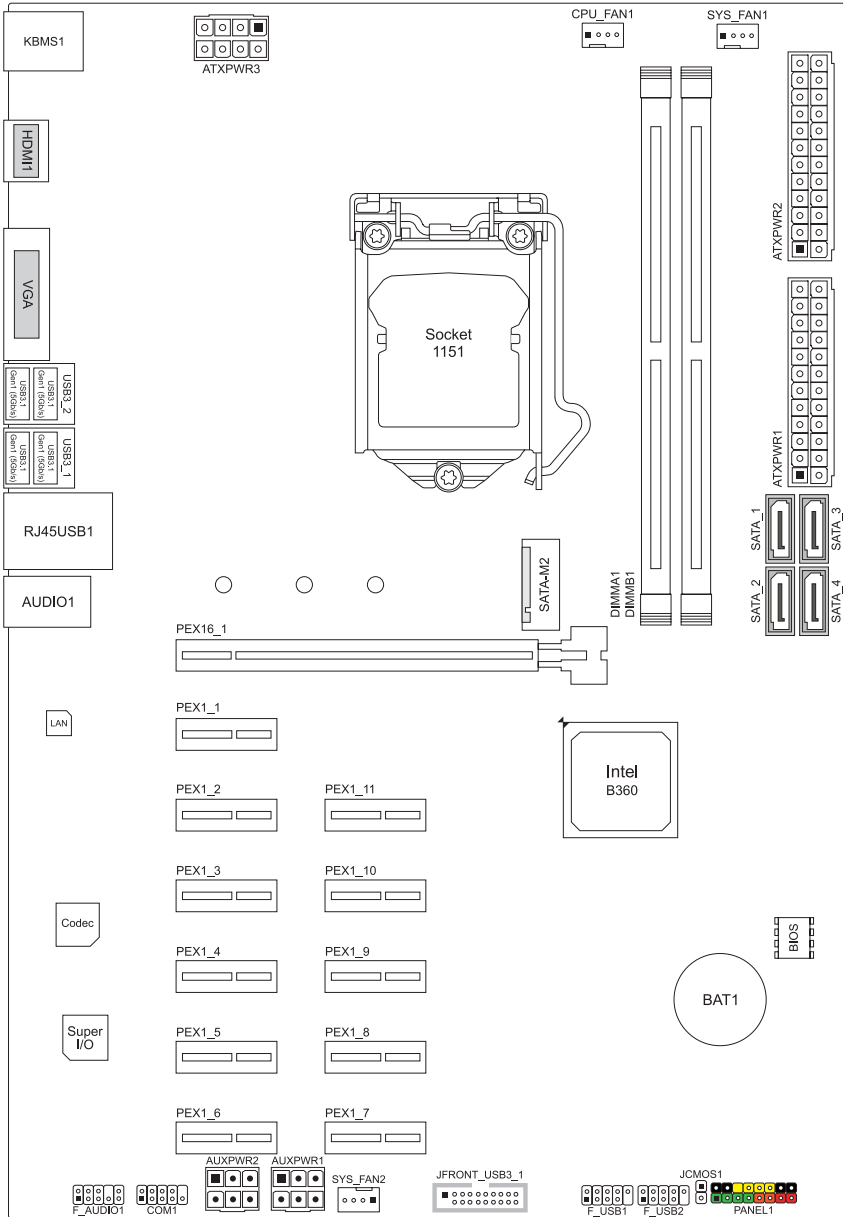

Note

» ■ represents the 1st pin.

TB360-BTC +

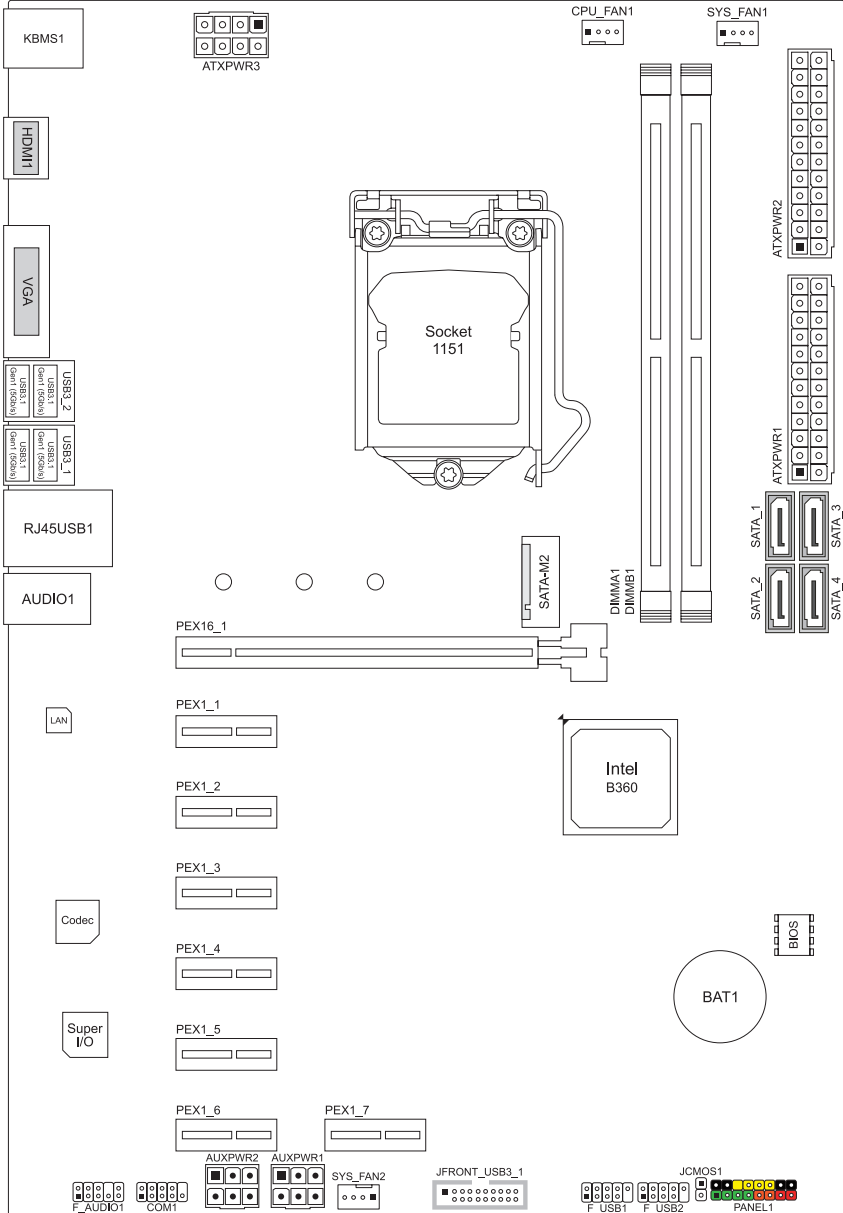

Note

» ■ represents the 1st pin.

TB360-BTC Expert

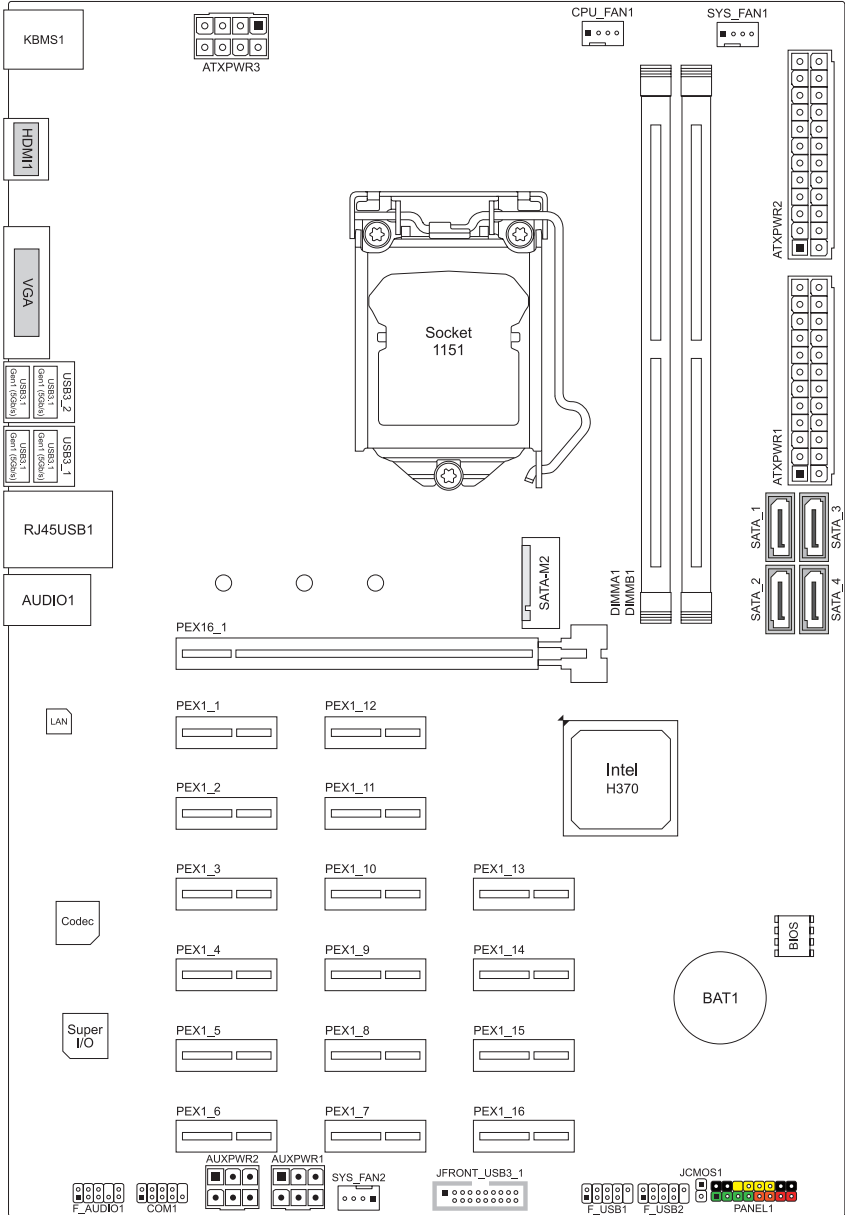

Note

» ■ represents the 1st pin.

Chapter 2: Hardware Installation

2.1 Install Central Processing Unit (CPU)

Step 1: Locate the CPU socket on the motherboard

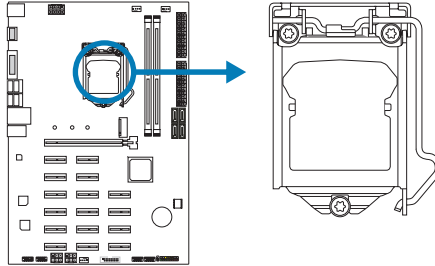

► **Note**

- » Remove pin cap before installation, and make good preservation for future use. When the CPU is removed, cover the pin cap on the empty socket to ensure pin legs won't be damaged.
- » The motherboard might equip with two different types of pin cap. Please refer below instruction to remove the pin cap.

Step 2: Pull the socket locking lever out from the socket and then raise the lever up.

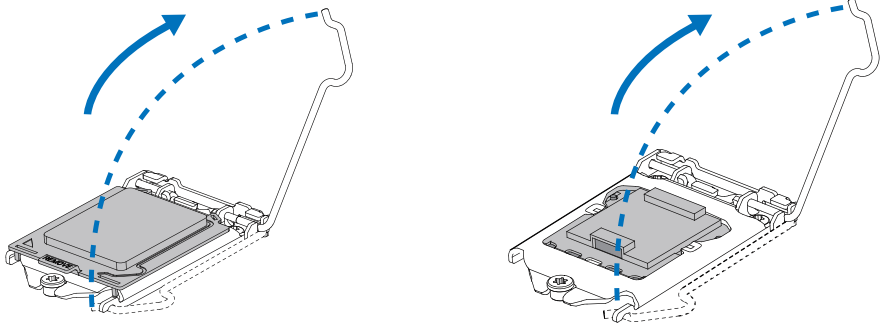

Step 3: Remove the Pin Cap.

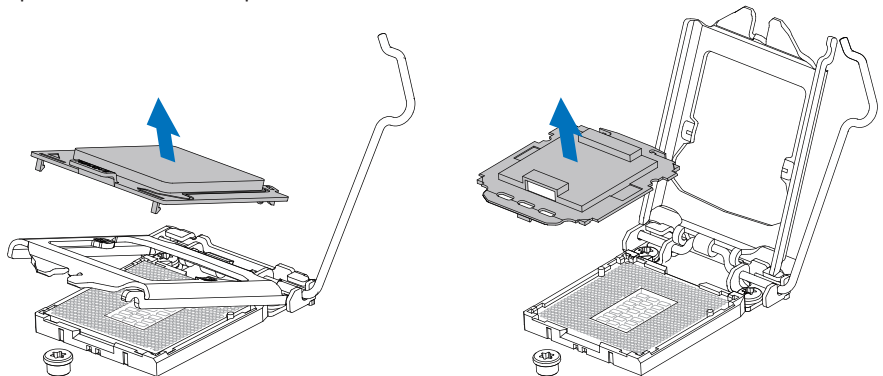

Step 4: Hold processor with your thumb and index fingers, oriented as shown. Align the notches with the socket. Lower the processor straight down without tilting or sliding the processor in the socket.

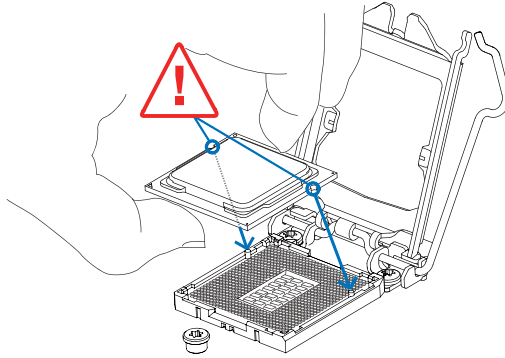

Step 5: Hold the CPU down firmly, and then lower the lever to locked position to complete the installation.

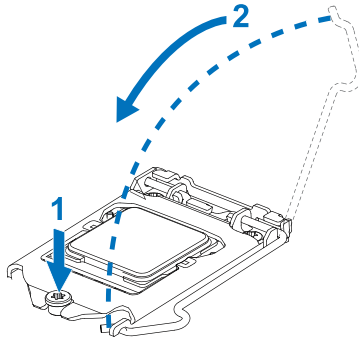

Note

- » Ensure that you install the correct CPU designed for LGA1151 socket.
 - » The CPU fits only in one correct orientation. Do not force the CPU into the socket to prevent damaging the CPU.
-

2.2 Install a Heatsink

Step 1: Place the CPU fan assembly on top of the installed CPU and make sure that the four fasteners match the motherboard holes. Orient the assembly and make the fan cable is closest to the CPU fan connector.

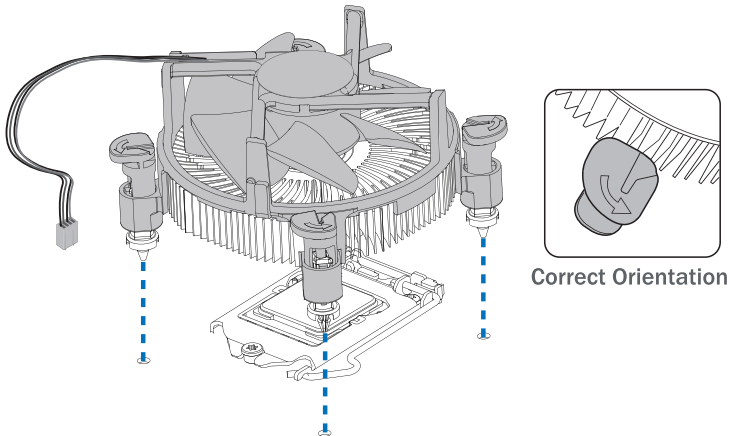

Step 2: Press down two fasteners at one time in a diagonal sequence to secure the CPU fan assembly in place. As each fastener locks into position a click should be heard.

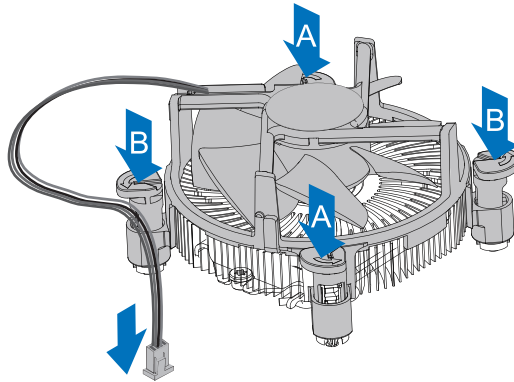

Note

- » Apply the thermal interface material on the CPU before heatsink installation, if necessary.
- » Do not forget to connect the CPU fan connector.
- » For proper installation, please kindly refer to the installation manual of your CPU heatsink.

2.3 Connect Cooling Fans

These fan headers support cooling-fans built in the computer. The fan cable and connector may be different according to the fan manufacturer.

CPU_FAN1: CPU Fan Header

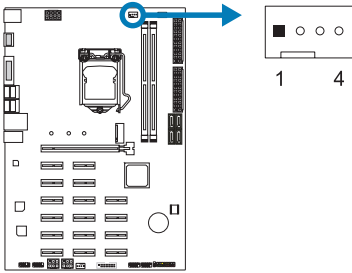

Pin	Assignment
1	Ground
2	+12V
3	FAN RPM rate sense
4	Smart Fan Control (By Fan)

SYS_FAN1/ SYS_FAN2: System Fan Header

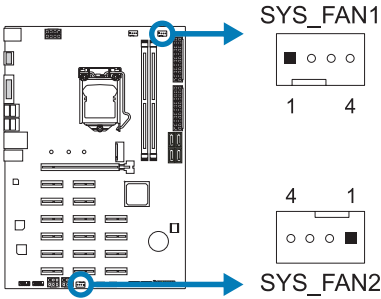

Pin	Assignment
1	Ground
2	+12V
3	FAN RPM rate sense
4	Smart Fan Control (By Fan)

Note

» CPU_FAN1, SYS_FAN1 & SYS_FAN2 support 4-pin and 3-pin head connectors. When connecting with wires onto connectors, please note that the red wire is the positive and should be connected to pin#2, and the black wire is Ground and should be connected to pin#1(GND).

2.4 Install System Memory

DDR4 Modules

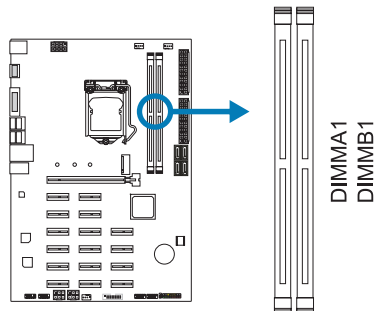

Step 1: Unlock a DIMM slot by pressing the retaining clips outward. Align a DIMM on the slot such that the notch on the DIMM matches the break on the slot.

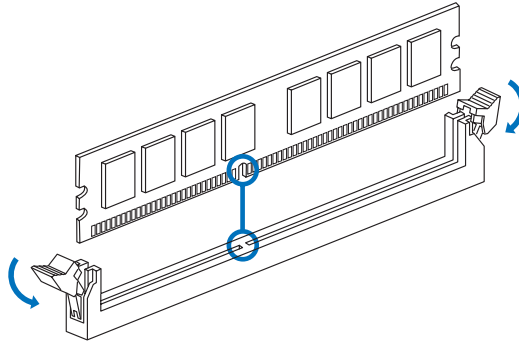

Step 2: Insert the DIMM vertically and firmly into the slot until the retaining clips snap back in place and the DIMM is properly seated.

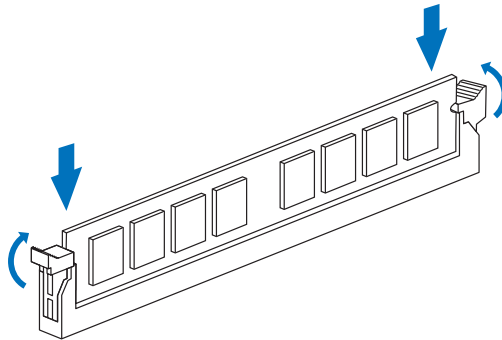

Note

» If the DIMM does not go in smoothly, do not force it. Pull it all the way out and try again.

Memory Capacity

DIMM Socket Location	DDR4 Module	Total Memory Size
DIMMA1	4GB/8GB/16GB	Max is 32GB.
DIMMB1	4GB/8GB/16GB	

Dual Channel Memory Installation

Please refer to the following requirements to activate Dual Channel function:
Install memory module of the same density in pairs, shown in the table.

Dual Channel Status	DIMMA1	DIMMB1
Disabled	O	X
Disabled	X	O
Enabled	O	O

(O means memory installed, X means memory not installed.)

Note

» When installing more than one memory module, we recommend to use the same brand and capacity memory on this motherboard.

2.5 Expansion Slots

PEX16_1: PCI-Express Gen3 x16 Slot

- PCI-Express 3.0 compliant.
- Theoretical maximum bandwidth using two slots simultaneously is 16GB/s for each slot, a total of 32GB/s.

<TB360-BTC PRO>

PEX1_1/ PEX1_2/ PEX1_3/ PEX1_4/ PEX1_5/ PEX1_6/ PEX1_7/ PEX1_8/ PEX1_9/
PEX1_10/ PEX1_11: PCI-Express Gen3 x1 Slots

<TB360-BTC+>

PEX1_1/ PEX1_2/ PEX1_3/ PEX1_4/ PEX1_5/ PEX1_6/ PEX1_7:

PCI-Express Gen3 x1 Slots

<TB360-BTC Expert>

PEX1_1/ PEX1_2/ PEX1_3/ PEX1_4/ PEX1_5/ PEX1_6/ PEX1_7/ PEX1_8/ PEX1_9/
PEX1_10/ PEX1_11/ PEX1_12/ PEX1_13/ PEX1_14/ PEX1_15/ PEX1_16:

PCI-Express Gen3 x1 Slots

- PCI-Express 3.0 compliant.
- Data transfer bandwidth up to 1GB/s per direction; 2GB/s in total

SATA-M2: M.2 (Key M) Slot

- The M.2 slot supports M.2 Type 2242/2260/2280 SSD module. When installing M.2 SSD module, please place the screw and hex pillar to correct position.
- Support M.2 SATA III (6.0 Gb/s) module.

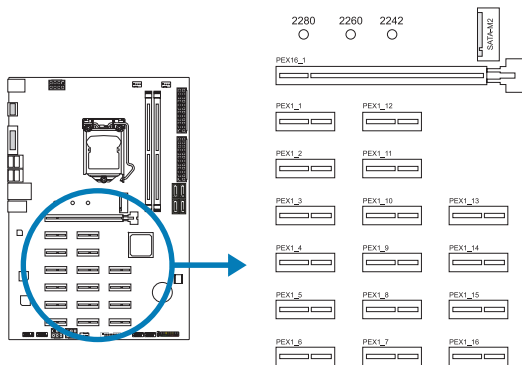

Note

» Maximum VGA cards mining support are depending on VGA Driver or mining software.

Install an Expansion Card

You can install your expansion card by following steps:

- Read the related expansion card's instruction document before install the expansion card into the computer.
- Remove your computer's chassis cover, screws and slot bracket from the computer.
- Place a card in the expansion slot and press down on the card until it is completely seated in the slot.
- Secure the card's metal bracket to the chassis back panel with a screw.
- Replace your computer's chassis cover.
- Power on the computer, if necessary, change BIOS settings for the expansion card.
- Install related driver for the expansion card.

2.6 Jumper & Switch Setting

The illustration shows how to set up jumpers. When the jumper cap is placed on pins, the jumper is "close", if not, that means the jumper is "open".

Pin opened



Pin closed



Pin 1-2 closed



JCMOS1: Clear CMOS Jumper

The jumper allows users to restore the BIOS safe setting and the CMOS data. Please carefully follow the procedures to avoid damaging the motherboard.

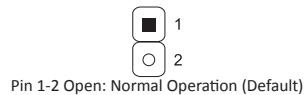
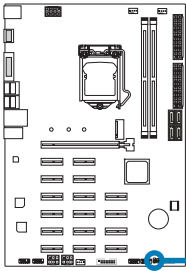

Clear CMOS Procedures:

1. Remove AC power line.
2. Set the jumper to "Pin 1-2 close", you can use a metal object like a screwdriver to touch the two pins.
3. Wait for five seconds.
4. After clearing the CMOS values, be sure the jumper is "Pin 1-2 open".
5. Power on the AC.
6. Load Optimal Defaults and save settings in CMOS.

2.7 Headers & Connectors

ATXPWR1/ ATXPWR2: ATX Power Source Connector

For better compatibility, we recommend to use a standard ATX 24-pin power supply for this connector. Make sure to find the correct orientation before plugging the connector.

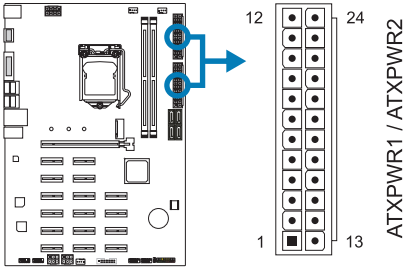

Pin	Assignment	Pin	Assignment
13	+3.3V	1	+3.3V
14	-12V	2	+3.3V
15	Ground	3	Ground
16	PS_ON	4	+5V
17	Ground	5	Ground
18	Ground	6	+5V
19	Ground	7	Ground
20	NC	8	PW_OK
21	+5V	9	Standby Voltage+5V
22	+5V	10	+12V
23	+5V	11	+12V
24	Ground	12	+3.3V

ATXPWR3: ATX Power Source Connector

The connector provides +12V to the CPU power circuit. If the CPU power plug is 4-pin, please plug it into Pin 1-2-5-6 of ATXPWR3.

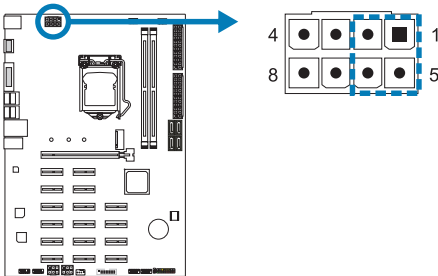

Pin	Assignment
1	+12V
2	+12V
3	+12V
4	+12V
5	Ground
6	Ground
7	Ground
8	Ground

Note

- » Before you power on the system, please make sure that both ATXPWR1/ ATXPWR2 and ATXPWR3 connectors have been plugged-in.
- » When there is only one power supply, the 24-pins ATX power connector must be connected to ATXPWR1, otherwise it will not boot.
- » When there are two power supply, please install the first power supply and connect the 24-pins ATX power connector to ATXPWR1 and the 8-pins ATX power connector to ATXPWR3. After installing the second power supply, the 24-pins ATX power connector is connected to ATXPWR2. If it is installed incorrectly, the motherboard will be damaged.
- » Insufficient power supplied to the system may result in instability or the peripherals not functioning properly. Use of a PSU with a higher power output is recommended when configuring a system with more power-consuming devices.

Install Two Power Supply Rule:

You can install your two power supply by following steps:

1. The 24-pins ATX power connector of power supply1 is connected to ATXPWR1.
2. The 8-pins or 4-pins ATX power connector of power supply1 is connected to ATXPWR3.
3. The 24-pins ATX power connector of power supply2 is connected to ATXPWR2.

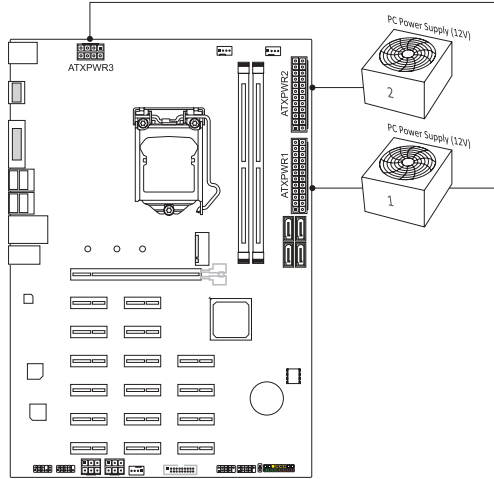

Note

» Ensure proper pin connecting to your ATX power connector, wrong connection may damage your motherboard.

AUXPWR1/ AUXPWR2: PCIe Power Source Connector

The connector provides +12V to the PCIe power circuit.

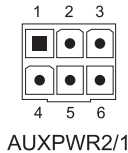
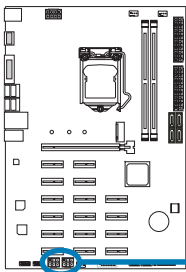

Pin	Assignment
1	+12V_Output
2	+12V_Output
3	+12V_Output
4	Ground
5	Ground
6	Ground

PANEL1: Front Panel Header

This 16-pin header includes Power-on, Reset, HDD LED, Power LED, and speaker connection.

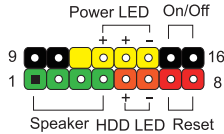
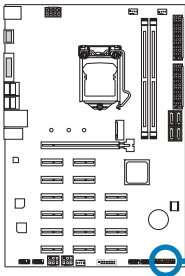

Pin	Assignment	Function	Pin	Assignment	Function
1	+5V	Speaker Connector	9	N/A	N/A
2	N/A		10	N/A	
3	N/A		11	N/A	
4	Speaker	Hard drive LED	12	Power LED (+)	Power LED
5	HDD LED (+)		13	Power LED (+)	
6	HDD LED (-)	Reset button	14	Power LED (-)	Power-on button
7	Ground		15	Power button	
8	Reset control		16	Ground	

SATA3_1/ SATA3_2/ SATA3_3/ SATA3_4: Serial ATA Connectors

These connectors connect to SATA hard disk drives via SATA cables.

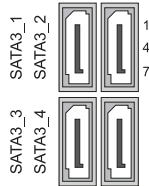
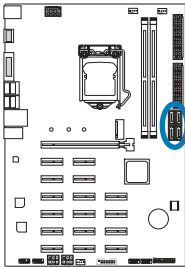

Pin	Assignment
1	Ground
2	TX+
3	TX-
4	Ground
5	RX-
6	RX+
7	Ground

JFRONT_USB3_1: Header for USB 3.0 Ports at Front Panel

This header allows user to add additional USB ports on the PC front panel, and also can be connected with a wide range of external peripherals.

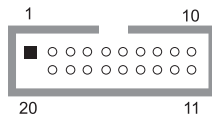
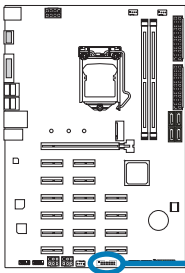

Pin	Assignment	Pin	Assignment
1	VBUS0	11	D2+
2	SSRX1-	12	D2-
3	SSRX1+	13	Ground
4	Ground	14	SSTX2+
5	SSTX1-	15	SSTX2-
6	SSTX1+	16	Ground
7	Ground	17	SSRX2+
8	D1-	18	SSRX2-
9	D1+	19	VBUS1
10	ID	20	Key

F_USB1/ F_USB2: Header for USB 2.0 Ports at Front Panel

This header allows user to add additional USB ports on the PC front panel, and also can be connected with a wide range of external peripherals.

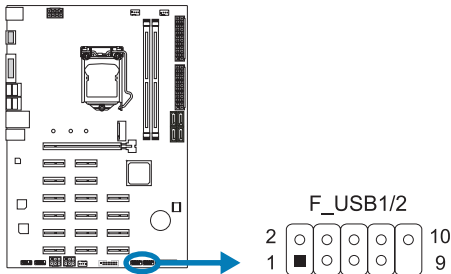

Pin	Assignment
1	+5V (fused)
2	+5V (fused)
3	USB-
4	USB-
5	USB+
6	USB+
7	Ground
8	Ground
9	Key
10	NC

F_AUDIO1: Front Panel Audio Header

This header allows user to connect the chassis-mount front panel audio I/O which supports HD and AC'97 audio standards.

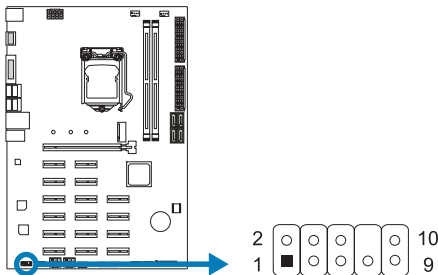

HD Audio		AC'97	
Pin	Assignment	Pin	Assignment
1	Mic Left in	1	Mic In
2	Ground	2	Ground
3	Mic Right in	3	Mic Power
4	GPIO	4	Audio Power
5	Right line in	5	RT Line Out
6	Jack Sense	6	RT Line Out
7	Front Sense	7	Reserved
8	Key	8	Key
9	Left line in	9	LFT Line Out
10	Jack Sense	10	LFT Line Out

Note

- » It is recommended that you connect a high-definition front panel audio module to this connector to avail of the motherboard's high definition audio capability.
- » Please try to disable the "Front Panel Jack Detection" if you want to use an AC'97 front audio output cable. The function can be found via O.S. Audio Utility.

COM1: Serial Port Header

The motherboard has a serial port header for connecting RS-232 Port.

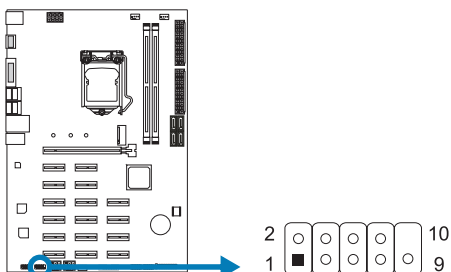

Pin	Assignment
1	Carrier detect
2	Received data
3	Transmitted data
4	Data terminal ready
5	Signal ground
6	Data set ready
7	Request to send
8	Clear to send
9	Ring indicator
10	Key

Chapter 3: UEFI BIOS & Software

3.1 UEFI BIOS Setup

- The BIOS Setup program can be used to view and change the BIOS settings for the computer. The BIOS Setup program is accessed by pressing the key after the Power-On Self-Test (POST) memory test begins and before the operating system boot begins.
- For further information of setting up the UEFI BIOS, please refer to the UEFI BIOS Manual on our website.

3.2 BIOS Update

The BIOS can be updated using either of the following utilities:

- **BIOSTAR BIOS-FLASHER:** Using this utility, the BIOS can be updated from a file on a hard disk, a USB drive (a flash drive or a USB hard drive), or a CD-ROM.
- **BIOSTAR BIOS Update Utility:** It enables automated updating while in the Windows environment. Using this utility, the BIOS can be updated from a file on a hard disk, a USB drive (a flash drive or a USB hard drive), or a CD-ROM, or from the file location on the Web.

BIOSTAR BIOS-FLASHER

Note

- » This utility only allows storage device with FAT32/16 format and single partition.
- » Shutting down or resetting the system while updating the BIOS will lead to system boot failure.

Updating BIOS with BIOSTAR BIOS-FLASHER

1. Go to the website to download the latest BIOS file for the motherboard.
2. Then, copy and save the BIOS file into a USB flash (pen) drive. (Only supported FAT/FAT32 format)
3. Insert the USB pen drive that contains the BIOS file to the USB port.
4. Power on or reset the computer and then press <F12> during the POST process.

5. After entering the POST screen, the BIOS-FLASHER utility pops out. Choose <fs0> to search for the BIOS file.



6. Select the proper BIOS file, and a message asking if you are sure to flash the BIOS file. Click “Yes” to start updating BIOS.



7. A dialog pops out after BIOS flash is completed, asking you to restart the system. Press the <Y> key to restart system.

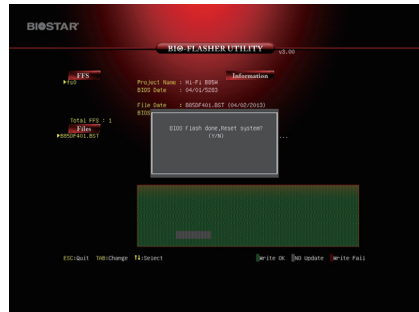

8. While the system boots up and the full screen logo shows up, press key to enter BIOS setup.

After entering the BIOS setup, please go to the <Save & Exit>, using the <Restore Defaults> function to load Optimized Defaults, and select <Save Changes and Reset> to restart the computer. Then the BIOS Update is completed.

BIOS Update Utility (through the Internet)

1. Installing BIOS Update Utility from the DVD Driver.
2. Please make sure the system is connected to the internet before using this function.

3. Launch BIOS Update Utility and click the “Online Update” button on the main screen.



4. An open dialog will show up to request your agreement to start the BIOS update. Click “Yes” to start the online update procedure.

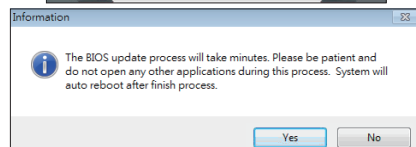

5. If there is a new BIOS version, the utility will ask you to download it. Click “Yes” to proceed.

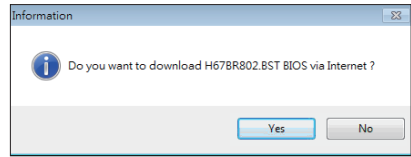

6. After the download is completed, you will be asked to program (update) the BIOS or not. Click “Yes” to proceed.

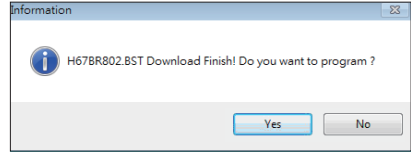

7. After the updating process is finished, you will be asked you to reboot the system. Click “OK” to reboot.

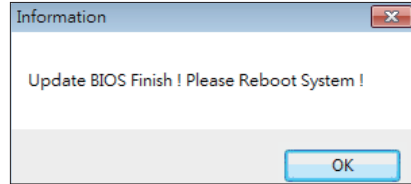

8. While the system boots up and the full screen logo shows up, press key to enter BIOS setup.

After entering the BIOS setup, please go to the <Save & Exit>, using the <Restore Defaults> function to load Optimized Defaults, and select <Save Changes> and <Reset> to restart the computer. Then, the BIOS Update is completed.

BIOS Update Utility (through a BIOS file)

1. Installing BIOS Update Utility from the DVD Driver.
2. Download the proper BIOS from <http://www.biostar.com.tw/>

3. Launch BIOS Update Utility and click the “Update BIOS” button on the main screen.



4. A warning message will show up to request your agreement to start the BIOS update. Click “OK” to start the update procedure.

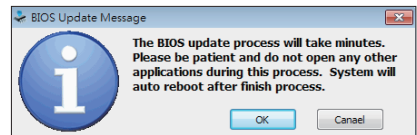

5. Choose the location for your BIOS file in the system. Please select the proper BIOS file, and then click on "Open". It will take several minutes, please be patient.

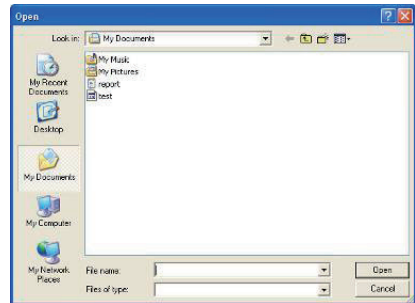

6. After the BIOS Update process is finished, click on "OK" to reboot the system.

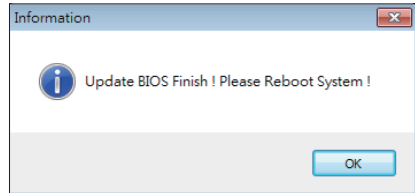

7. While the system boots up and the full screen logo shows up, press key to enter BIOS setup.

After entering the BIOS setup, please go to the <Save & Exit>, using the <Restore Defaults> function to load Optimized Defaults, and select <Save Changes and Reset> to restart the computer. Then, the BIOS Update is completed.

Backup BIOS

Click the Backup BIOS button on the main screen for the backup of BIOS, and select a proper location for your backup BIOS file in the system, and click "Save".

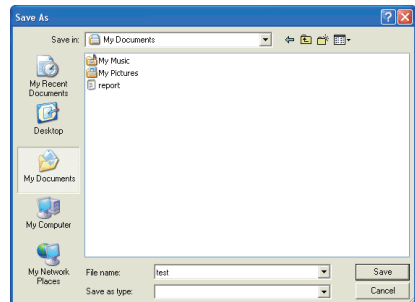

3.3 Software

Installing Software

1. Insert the Setup DVD to the optical drive. The driver installation program would appear if the Auto-run function has been enabled.
2. Select Software Installation, and then click on the respective software title.
3. Follow the on-screen instructions to complete the installation.

Launching Software

After the installation process is completed, you will see the software icon showing on the desktop. Double-click the icon to launch it.

Note

- » All the information and content about following software are subject to be changed without notice. For better performance, the software is being continuously updated.
- » The information and pictures described below are for your reference only. The actual information and settings on board may be slightly different from this manual.

BIOScreen Utility

This utility allows you to personalize your boot logo easily. You can choose BMP as your boot logo so as to customize your computer.



Please follow the step-by-step instructions below to update boot logo:

- Load Image: Choose the picture as the boot logo.
- Transform: Transform the picture for BIOS and preview the result.
- Update Bios: Write the picture to BIOS Memory to complete the update.

eHot-Line

eHot-Line is a convenient utility that helps you to contact with our Tech-Support system. This utility will collect the system information which is useful for analyzing the problem you may have encountered, and then send these information to our tech-support department to help you fix the problem.

* represents important information that you must provide. Without this information, you may not be able to send out the mail.

The screenshot shows the eHot-Line utility window. On the left, there is a text area displaying system information: Base board information: Caption: Base Board, CreationClassName: Win32_Base, Description: Base Board, HostingBoard: TRUE, HotSwappable: FALSE, Manufacturer: BIOSTAR Group, Name: Base Board, PoweredOn: TRUE, Product: TA780C M2+, Removable: FALSE, Replaceable: TRUE, RequiresDaughterBoard: FALSE, SerialNumber: None, Status: OK, Tag: Base Board, Version: 6.0. The main area is titled 'Symptom Description:' and contains a large empty text box for user input. Below this are several input fields: 'Region:' with a dropdown arrow, 'CC E-mail:' with a text box, 'Memory Module Manufacture:' with a text box, and 'Power Supply Manufacture/model:' with a text box. At the bottom are three buttons: 'Send', 'Save As...', and 'Exit'. Red annotations with arrows point to various parts of the interface: 'This block will show the information which would be collected in the mail.' points to the system information text area; '* Describe condition of your system.' points to the Symptom Description text box; '* Select your area or the area close to you.' points to the Region dropdown; 'Provide the e-mail address that you would like to send the copy to.' points to the CC E-mail text box; '* Provide the name of the memory module manufacturer.' points to the Memory Module Manufacture text box; 'Provide the name of the power supply manufacturer and the model no.' points to the Power Supply Manufacture/model text box; 'Send the mail out.' points to the Send button; 'Exit this dialog.' points to the Exit button; and 'Save these information to a .txt file' points to the Save As... button.

After filling up this information, click “Send” to send the mail out. A warning dialog would appear asking for your confirmation; click “Send” to confirm or “Do Not Send” to cancel.

If you want to save this information to a .txt file, click “Save As...” and then you will see a saving dialog appears asking you to enter file name.

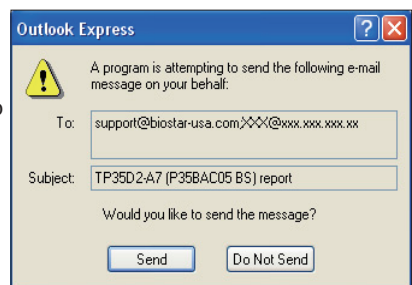

Enter the file name and then click “Save”. Your system information will be saved to a .txt file.

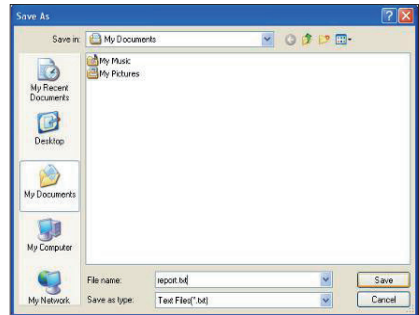

Open the saved .txt file, you will see your system information including motherboard/BIOS/CPU/video/device/OS information. This information is also concluded in the sent mail.

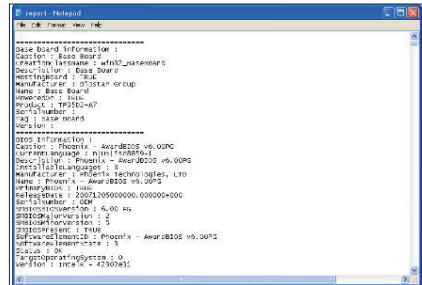

Note

- » Before you use this utility, please set Outlook Express as your default e-mail client application program.
- » We will not share customer's data with any other third parties, so please feel free to provide your system information while using eHot-Line service.
- » If you are not using Outlook Express as your default e-mail client application, you may need to save the system information to a .txt file and send the file to our tech support with other e-mail application. Go to the following website <http://www.biostar.com.tw/app/en/about/contact.php> for getting our contact information.

Chapter 4: Useful help

4.1 Driver Installation

After you installed your operating system, please insert the Fully Setup Driver DVD into your optical drive and install the driver for better system performance.

You will see the following window after you insert the DVD



The setup guide will auto detect your motherboard and operating system.

A. Driver Installation

To install the driver, please click on the Driver icon. The setup guide will list the compatible driver for your motherboard and operating system. Click on each device driver to launch the installation program.

B. Software Installation

To install the software, please click on the Software icon. The setup guide will list the software available for your system, click on each software title to launch the installation program.

C. Manual

Aside from the paperback manual, we also provide manual in the Driver DVD. Click on the Manual icon to browse for available manual.

► Note

- » *If this window didn't show up after you insert the Driver DVD, please use file browser to locate and execute the file SETUP.EXE under your optical drive.*
- » *You will need Acrobat Reader to open the manual file. Please download the latest version of Acrobat Reader software from <http://get.adobe.com/reader/>*

4.2 AMI BIOS Beep Code

Boot Block Beep Codes

Number of Beeps	Description
Continuing	Memory sizing error or Memory module not found

POST BIOS Beep Codes

Number of Beeps	Description
1	Success booting.
8	Display memory error (system video adapter)

4.3 AMI BIOS post code

Code	Description
10	PEI Core is started
11	Pre-memory CPU initialization is started
15	Pre-memory North Bridge initialization is started
19	Pre-memory South Bridge initialization is started
2B	Memory initialization. Serial Presence Detect (SPD) data reading
2C	Memory initialization. Memory presence detection
2D	Memory initialization. Programming memory timing information
2E	Memory initialization. Configuring memory
2F	Memory initialization (other).
31	Memory Installed
32	CPU post-memory initialization is started
33	CPU post-memory initialization. Cache initialization
34	CPU post-memory initialization. Application Processor(s) (AP) initialization
35	CPU post-memory initialization. Boot Strap Processor (BSP) selection
36	CPU post-memory initialization. System Management Mode (SMM) initialization
37	Post-Memory North Bridge initialization is started
3B	Post-Memory North Bridge initialization (North Bridge module specific)
4F	DXE IPL is started
60	DXE Core is started
F0	Recovery condition triggered by firmware (Auto recovery)
F1	Recovery condition triggered by user (Forced recovery)
F2	Recovery process started
F3	Recovery firmware image is found
F4	Recovery firmware image is loaded
E0	S3 Resume is started (S3 Resume PPI is called by the DXE IPL)
E1	S3 Boot Script execution
E2	Video repost
E3	OS S3 wake vector call
60	DXE Core is started
61	NVRAM initialization
62	Installation of the South Bridge Runtime Services
63	CPU DXE initialization is started
68	PCI host bridge initialization
69	North Bridge DXE initialization is started
6A	North Bridge DXE SMM initialization is started

Code	Description
70	South Bridge DXE initialization is started
71	South Bridge DXE SMM initialization is started
72	South Bridge devices initialization
78	South Bridge DXE Initialization (South Bridge module specific)
79	ACPI module initialization
90	Boot Device Selection (BDS) phase is started
91	Driver connecting is started
92	PCI Bus initialization is started
93	PCI Bus Hot Plug Controller Initialization
94	PCI Bus Enumeration
95	PCI Bus Request Resources
96	PCI Bus Assign Resources
97	Console Output devices connect
98	Console input devices connect
99	Super IO Initialization
9A	USB initialization is started
9B	USB Reset
9C	USB Detect
9D	USB Enable
A0	IDE initialization is started
A1	IDE Reset
A2	IDE Detect
A3	IDE Enable
A4	SCSI initialization is started
A5	SCSI Reset
A6	SCSI Detect
A7	SCSI Enable
A8	Setup Verifying Password
A9	Start of Setup
AB	Setup Input Wait
AD	Ready To Boot event
AE	Legacy Boot event
AF	Exit Boot Services event
B0	Runtime Set Virtual Address MAP Begin
B1	Runtime Set Virtual Address MAP End
B2	Legacy Option ROM Initialization
B3	System Reset
B4	USB hot plug
B5	PCI bus hot plug
B6	Clean-up of NVRAM
B7	Configuration Reset (reset of NVRAM settings)

4.4 Troubleshooting

Probable	Solution
<ol style="list-style-type: none"> 1. There is no power in the system. Power LED does not shine; the fan of the power supply does not work. 2. Indicator light on keyboard does not shine. 	<ol style="list-style-type: none"> 1. Make sure power cable is securely plugged in. 2. Replace cable. 3. Contact technical support.
System is inoperative. Keyboard lights are on, power indicator lights are lit, and hard drives are running.	Using even pressure on both ends of the DIMM, press down firmly until the module snaps into place.
System does not boot from a hard disk drive, but can be booted from optical drive.	<ol style="list-style-type: none"> 1. Check cable running from disk to disk controller board. Make sure both ends are securely plugged in; check the drive type in the standard CMOS setup. 2. Backing up the hard drive is extremely important. All hard disks are capable of breaking down at any time.
System only boots from an optical drive. Hard disks can be read, applications can be used, but system fails to boot from a hard disk.	<ol style="list-style-type: none"> 1. Back up data and applications files. 2. Reformat the hard drive. Re-install applications and data using backup disks.
Screen message shows "Invalid Configuration" or "CMOS Failure."	Review system's equipment. Make sure correct information is in setup.
System cannot boot after user installs a second hard drive.	<ol style="list-style-type: none"> 1. Set master/slave jumpers correctly. 2. Run SETUP program and select correct drive types. Call the drive manufacturers for compatibility with other drives.

CPU Overheated

If the system shutdown automatically after power on system for seconds, that means the CPU protection function has been activated.

When the CPU is over heated, the motherboard will shutdown automatically to avoid a damage of the CPU, and the system may not power on again.

In this case, please double check:

1. The CPU cooler surface is placed evenly with the CPU surface.
2. CPU fan is rotated normally.
3. CPU fan speed is fulfilling with the CPU speed.

After confirmed, please follow steps below to relief the CPU protection function.

1. Remove the power cord from power supply for seconds.
2. Wait for seconds.
3. Plug in the power cord and boot up the system.

Or you can:

1. Clear the CMOS data. (See "Close CMOS Header: JCMOS1" section)
2. Wait for seconds.
3. Power on the system again.

APPENDIX I: Specifications in Other Languages

Arabic

المواصفات		
المأخذ 1151 لمعالج ايه إم دي Intel® Core i7 / i5 / i3 / Pentium / Celeron (الجيل 8) الحد الأقصى للطاقة الحرارية في تصميم المعالج (TDP – thermal design power) : 95 واط. * تدعم الجيل 8 من Intel® كور™ عائلة المعالج 300 سلسلة فقط. * يرجى الرجوع إلى الموقع www.biostar.com.tw لقائمة دعم المعالج CPU.		
INTEL® B360 :TB360-BTC+ & TB360-BTC PRO INTEL® H370 :TB360-BTC Expert		
ي دعم قناة واحدة DDR4 1866/2133/2400/2666 2x دي. دي. آر. DDR4 فتحات الذاكرة المزدوجة DIMM، تتحمل كحد أقصى 32 جيجابايت ذاكرة كل فتحة مزدوجة DIMM تتحمل دون ECC 16/8/4 جيجابايت دي. دي. آر DDR4 * يرجى الرجوع إلى الموقع www.biostar.com.tw لقائمة دعم الذاكرة.		
صلة 4x ساتا SATA III(6Gb/s) x1 فتحة (6Gb/s) M.2 :تدعم SSD SATA التخزين		
RTL8111H شبكة محلية LAN 1000 / 100 / 10 ميجابايت / الثانية ، تحديد تلقائي ، النصف / القدرة القصوى المزدوجة		
ALC887 الترميز الصوتي 7.1 قنوات عالية الدقة		
منافذ x 6 ناقل متسلسل عام USB 3.1 (Gen1) (4 في المداخل والمخارج الخلفية و 2 من خلال الموزع الداخلي) منافذ x 6 ناقل متسلسل عام USB 2.0 (2 في المداخل والمخارج الخلفية و 4 من خلال الموزع الداخلي)		
TB360-BTC Expert :	TB360-BTC+ :	TB360-BTC PRO:
x 16 فتحة منفذ الملحقات الإضافية PCIe	x 7 فتحة منفذ الملحقات الإضافية PCIe	x 11 فتحة منفذ الملحقات الإضافية PCIe
1 x 3.0 PCIe	1 x 3.0	1 x 3.0
x 1 فتحة منفذ الملحقات الإضافية PCIe	x 1 فتحة منفذ الملحقات الإضافية PCIe	x 1 فتحة منفذ الملحقات الإضافية PCIe
16 x 3.0	16 x 3.0	16 x 3.0
*الحد الأقصى لدعم بطاقات فغا التعدين تعتمد على برنامج تشغيل فغا أو التعدين.		
x 1 PS/2 لوحة المفاتيح للكمبيوتر x 1 PS/2 الفأرة فتحة توصيل عدد 1 x واجهة مرئية رقمية VGA فتحة توصيل عدد 1 x واجهة مرئية رقمية HDMI فتحة لتوصيل عدد 1 x الشبكة المحلية LAN فتحة توصيل عدد 2 x ناقل متسلسل عام USB 2.0 فتحة توصيل عدد 4 x ناقل متسلسل عام USB 3.1 (Gen1) فتحة توصيل عدد 3 x جاك للصوت		
وصلة 4x ساتا SATA III (6Gb/s) موزع 2 x ناقل متسلسل عام USB 2.0 (كل موزع يتحمل فتحتين ناقل متسلسل عام USB 2.0) موزع 1 x ناقل متسلسل عام USB 3.1 (Gen1) (كل موزع يتحمل فتحتين ناقل متسلسل عام USB 3.1(Gen1)) وصلة للطاقة 1 x 8 دبابيس وصلة للطاقة 2 x 24 دبابيس وصلة للطاقة 1 x 6 دبابيس (12V_In اللوحة الأم) وصلة للطاقة 1 x 6 دبابيس (VGA ل 12V_Out) وصلة 1 x مروحة تبريد وحدة المعالجة المركزية وصلة 2 x مرواح تبريد المنظومة موزع 1 x اللوحة الامامية موزع 1 x الصوت الامامي موزع 1 x فتحة تسلسلية موزع 1 x CMOS Clear		
معالج الشكل مدد التكنولوجيا المتقدمة ATX ، 305 مم x 210 مم		
ويندوز 10(64bit)		
* بيوستار BIOSTAR تحتفظ بحق إضافة أو إزالة الدعم لأي نظام تشغيل مع أو بدون أظهار.		

German

Spezifikationen			
CPU-Unterstützung	Anschluss-1151 für den 8. Intel® Core i7 / i5 / i3 / Pentium / Celeron Prozessor Maximale CPU TDP (Thermal Design Power): 95 Watt * 8. Generation Intel® Core™ Prozessor Familie unterstützt nur 300-Serie. * Bitte konsultieren Sie www.biostar.com.tw für CPU-Unterstützungsliste		
Chipset	TB360-BTC PRO & TB360-BTC+ : INTEL® B360 TB360-BTC Expert: INTEL® H370		
Festplattenspeicher	Unterstützt zweikanaliges DDR4 1866/2133/2400/2666 2x DDR4 DIMM-SpeicherSlot, Max. Unterstützung bis zu 32 GB-Speicher Jedes DIMM unterstützt nicht-ECC 4/8/16 GB DDR4-Module * Bitte konsultieren Sie www.biostar.com.tw für Speicherunterstützung Liste.		
Arbeitsspeicher	4x SATA III-Verbindung (6Gb/s) 1x M.2 (6Gb/s): Unterstützt SATA SSD		
LAN	RTL8111H 10/ 100/ 1000 Mb Auto-Negotiation, Halb- / Voll-Duplex-fähig		
Audio-Codec	ALC887 7.1 Kanäle, HD-Audio		
USB	6x USB 3.1(Gen1)-Port (4 hintere I/Os und 2 via interne Header) 6x USB 2.0-Port (2 hintere I/Os und 4 via interne Header)		
Erweiterungsanschlüsse	TB360-BTC PRO:	TB360-BTC+ :	TB360-BTC Expert:
	11x PCIe 3.0 x1-Slot 1x PCIe 3.0 x16-Slot	7x PCIe 3.0 x1-Slot 1x PCIe 3.0 x16-Slot	16x PCIe 3.0 x1-Slot 1x PCIe 3.0 x16-Slot
	* Maximale VGA-Karten Bergbau-Unterstützung sind abhängig von VGA-Treiber oder Bergbau-Software.		
Hintere I/Os	1x PS/2-Maus 1x PS/2-Keyboard 1x VGA-Port 1x HDMI-Port 1x LAN-Port 2x USB 2.0-Port 4x USB 3.1(Gen1)-Port 3x Audio Jack		
Interne I/Os	4x SATA III-Verbindung (6Gb/s) 2x USB 2.0-Header (jeder Header unterstützt 2 USB 2.0-Ports) 1x USB 3.1(Gen1)-Header (jeder Header unterstützt 2 USB 3.1(Gen1)-Ports) 1x 8-Pin-Stromverbindung 2x 24-Pin-Stromverbindung 1x 6-Pin-Stromverbindung (12V_In für Motherboard) 1x 6-Pin-Stromverbindung (12V_Out für VGA Card) 1x CPU-Ventilatorverbindung 2x System-Ventilatorverbindung 1x Header für Frontpanel 1x Header für Frontaudio 1x Header für Seriellen Anschluss 1x Header für klares CMOS		
Formfaktor	ATX Formfaktor, 305 mm x 210mm		
OS-Unterstützung	Windows 10(64bit) * Biostar reserves the right to add or remove support for any OS with or without notice.		

Russian

Спецификации			
Поддержка центрального процессора	Сокет 1151 для 8-го процессоров Intel® Core i7 / i5 / i3 / Pentium / Celeron Максимальный термопакет центрального процессора (TDP): 95 ватт * Семейство процессоров Intel® Core™ 8-го поколения поддерживает только 300-Series. * Перечень поддержки центрального процессора смотрите на www.biostar.com.tw .		
Набор микросхем	TB360-BTC PRO & TB360-BTC+ : INTEL® B360 TB360-BTC Expert: INTEL® H370		
Память	Поддерживает двухканальный DDR4 1866/2133/2400/2666 2 гнезда платы памяти DDR4 DIMM, максимальная память до 32 Гб Каждый модуль DIMM поддерживает модуль не-ECC 4/8/16 Гб DDR4 * Перечень поддержки памяти смотрите на www.biostar.com.tw .		
Накопитель	Соединитель 4x SATA III (6Gb/s) 1x M.2 (6Gb/s): Поддерживает SATA SSD		
Локальная сеть	RTL8111H Автоогласование 10/ 100/ 1000 Мб/с, работает в полно/полудуплексном режиме		
Аудиокодек	ALC887 Каналы 7.1, высококачественное аудио		
USB	6 порта USB 3.1(Gen1) (4 сзади ввода-вывода и 2 через внутренние контакты) 6 порта USB 2.0 (2 сзади ввода-вывода и 4 через внутренние контакты)		
Гнезда расшир.	TB360-BTC PRO:	TB360-BTC+ :	TB360-BTC Expert:
	11x PCIe 3.0 x1 гнездо 1x PCIe 3.0 x16 гнездо	7x PCIe 3.0 x1 гнездо 1x PCIe 3.0 x16 гнездо	16x PCIe 3.0 x1 гнездо 1x PCIe 3.0 x16 гнездо
	* Поддержка максимальной поддержки VGA-карт зависит от драйвера VGA или программного обеспечения для горнодобывающей промышленности.		
Задняя плата ввода-вывода	1 мышь PS/2 1 клавиатура PS/2 1 порт VGA 1 порт HDMI 1 порт локальной сети 2 порта USB 2.0 4 порта USB 3.1(Gen1) 3 гнезд для подключения наушников		
Внутр. Плата ввода-вывода	Соединитель 4x SATA III (6Gb/s) 2 контакта USB 2.0 (каждый контакт поддерживает 2 порта USB 2.0) 1 контакт USB 3.1(Gen1) (каждый контакт поддерживает 2 порта USB 3.1(Gen1)) 1 8-выводный разъем питания 2 24-выводный разъем питания 1 6-выводный разъем питания (12V_In для Материнская плата) 1 6-выводный разъем питания (12V_Out для VGA Card) 1 разъем вентилятора ЦП 2 разъема вентилятора системы 1 контакт передней панели 1 контакт передней аудиопанели 1 контакт последовательного порта 1 контакт микросхемы Clear CMOS		
Конструктив	Форм-фактор ATX, 305мм x 210мм		
Поддержка ОС	Windows 10(64bit) * Biostar оставляет за собой право добавлять или удалять поддержку любой ОС, с уведомлением или без.		

Spanish

Especificaciones			
Compatibilidad con el procesador	Ranura 1151 para el 8º procesador Intel® Core i7 / i5 / i3 / Pentium / Celeron Alimentación de Proyección Térmica (TDP – Thermal Design Power): 95Watt * La familia de procesadores Intel® Core™ de 8ª generación sólo admite la serie 300. * Por favor consultar con www.biostar.com.tw para la lista de compatibilidad con el procesador.		
Tipo de Placa	TB360-BTC PRO & TB360-BTC+ : INTEL® B360 TB360-BTC Expert: INTEL® H370		
Memoria	Soporta DDR4 1866/2133/2400/2666 Doble Canal 2x DDR4 DIMM Ranura de memoria Soporta hasta 32 GB Memoria Cada DIMM soporta un modulo non-ECC 4/8/16 GB DDR4 * Por favor consultar con www.biostar.com.tw para la lista de compatibilidad con el memoria.		
Almacenamiento de información	Conector 4x SATA III (6Gb/s) 1x M.2 (6Gb/s): Soporta SATA SSD		
LAN	RTL8111H 10/ 100/ 1000 Mb/s auto negociación, capacidad dúplex Mitad/Completo		
Códec Audio	ALC887 Canales Audio de Alta Definición 7.1		
USB	Ranura 6x USB 3.1(Gen1) (4 en las entrada/salidas posteriores y 2 por los distribuidores internos) Ranura 6x USB 2.0 (2 en las entrada/salidas posteriores y 4 por los distribuidores internos)		
Ranuras de Extinción	TB360-BTC PRO: Ranura 11x PCIe 3.0 x1 Ranura 1x PCIe 3.0 x16	TB360-BTC+ : Ranura 7x PCIe 3.0 x1 Ranura 1x PCIe 3.0 x16	TB360-BTC Expert: Ranura 16x PCIe 3.0 x1 Ranura 1x PCIe 3.0 x16
	* El soporte de minería de tarjetas VGA máximo depende del controlador VGA o del software de minería.		
Panel trasero de E/S	Ratón 1x PS/2 Teclado 1x PS/2 Ranura 1x VGA Ranura 1x HDMI Ranura 1x LAN Ranura 2x USB 2.0 Ranura 4x USB 3.1(Gen1) Socket audio 3x		
Conectores en placa	Conector 4x SATA III Distribuidor 2x USB 2.0 (cada distribuidor soporta 2 ranuras USB 2.0) Distribuidor 1x USB 3.1(Gen1) (cada distribuidor soporta 2 ranuras USB 3.1(Gen1)) Conector con 8 patillas x1 Conector con 24 patillas x2 Conector con 6 patillas x1 (12V_In para tarjeta madre) Conector con 6 patillas x1 (12V_Out para Tarjeta VGA) Conector Ventilador procesador x1 Conector Ventilador Sistema x2 Distribuidor Panel Frontal x1 Distribuidor Audio Frontal x1 Distribuidor Ranura Serie x1 Distribuidor CMOS Directo x1		
Factor de Forma	Factor de Forma ATX, 305mm x 210mm		
Soporte OS	Windows 10(64bit) * Biostar reserva su derecho de añadir o retirar el soporte para cada OS con o sin notificación.		

Thai

คุณสมบัติ			
ซีพียู	ซีอ็อกเก็ด 1151 สำหรับโปรเซสเซอร์ 8th Intel® Core i7 / i5 / i3 / Pentium / Celeron CPU TDP (Thermal Design Power) สูงสุด: 95Watt * ตระกูลโปรเซสเซอร์ Intel® Core™ รุ่นที่ 8 รองรับเฉพาะ 300-Series * เข้าชมได้ที่ www.biostar.com.tw สำหรับรายการซีพียูที่สนับสนุน		
ชิพเซ็ต	TB360-BTC PRO & TB360-BTC+ : INTEL® B360 TB360-BTC Expert: INTEL® H370		
หน่วยความจำ	สนับสนุน Dual Channel DDR4 1866/2133/2400/2666 รองรับหน่วยความจำ 2 สล็อต DDR4 DIMM สูงสุดถึง 32 GB ทุก DIMM สนับสนุนโมดูล non-ECC 4/8/16GB DDR4 * เข้าชมได้ที่ www.biostar.com.tw สำหรับรายการหน่วยความจำที่สนับสนุน		
กราฟฟิก	รวมกราฟฟิกลอยู่ในซีพียู		
สตอเรจ	4x SATA III พอร์ตเชื่อมต่อ (6Gb/s) 1x M.2 (6Gb/s): สนับสนุน SATA SSD		
แลน	RTL8111H 10/ 100/ 1000 Mb/s การเจรจาอัตโนมัติ, ความสามารถในการเพิร์ล็กซ์ Half / Full		
ออดิโอ โคอเดก	ALC887 7.1 Channels, High Definition Audio		
ยูเอสบี	6x USB 3.1(Gen1) พอร์ต (4 พอร์ตด้านหลัง I/O และ 2 พอร์ต ผ่านพอร์ตเชื่อมต่อด้านใน) 6x USB 2.0 พอร์ต (2 พอร์ตด้านหลัง I/O และ 4 พอร์ต ผ่านพอร์ตเชื่อมต่อด้านใน)		
สล็อตขยายเพิ่มเติม	TB360-BTC PRO: 11x PCIe 3.0 x1 สล็อต 1x PCIe 3.0 x16 สล็อต	TB360-BTC+ : 7x PCIe 3.0 x1 สล็อต 1x PCIe 3.0 x16 สล็อต	TB360-BTC Expert: 16x PCIe 3.0 x1 สล็อต 1x PCIe 3.0 x16 สล็อต
	* การสนับสนุนการทำเหมืองข้อมูลการ์ด VGA สูงสุดขึ้นอยู่กับไดรเวอร์ VGA หรือซอฟต์แวร์การทำเหมืองแร่		
พอร์ต I/O ด้านหลัง	1x PS/2 เมาส์ 1x PS/2 คีย์บอร์ด 1x VGA พอร์ต 1x HDMI พอร์ต 1x LAN พอร์ต 2x USB 2.0 พอร์ต 4x USB 3.1(Gen1) พอร์ต 3x Audio Jack		
พอร์ต I/O ด้านใน	4x SATA III พอร์ตเชื่อมต่อ (6Gb/s) 2x USB 2.0 พอร์ตเชื่อมต่อ (หัวเชื่อมต่อทุกตัวรองรับ 2 พอร์ต USB 2.0) 1x USB 3.1(Gen1) พอร์ตเชื่อมต่อ (หัวเชื่อมต่อทุกตัวรองรับ 2 พอร์ต USB 3.1(Gen1)) 1x 8-Pin Power พอร์ตเชื่อมต่อ 2x 24-Pin Power พอร์ตเชื่อมต่อ 1x 6-Pin Power พอร์ตเชื่อมต่อ (12V_In สำหรับ เมนบอร์ด) 1x 6-Pin Power พอร์ตเชื่อมต่อ (12V_Out สำหรับ VGA Card) 1x พอร์ตเชื่อมต่อ CPU Fan 2x พอร์ตเชื่อมต่อระบบ Fan 1x พอร์ตเชื่อมต่อแผงด้านหน้า 1x พอร์ตเชื่อมต่อออดิโอด้านหน้า 1x พอร์ตเชื่อมต่อ Serial Port 1x พอร์ต Clear CMOS		
รูปแบบจากโรงงาน	ขนาด ATX จากโรงงาน, 210 มม. x 305 มม. Windows 10(64bit)		
สนับสนุน OS	* Biostar ขอสงวนสิทธิ์ในการเพิ่มหรือลดการสนับสนุนสำหรับระบบปฏิบัติการ OS ต่างๆ โดยไม่ต้องแจ้งให้ทราบล่วงหน้า		

this page intentionally left blank