

Bedienungsanleitung Diese Bedienungsanleitung ist mit dem ausgefüllten Garantieschein dem Kunden auszuhändigen.

Operating instructions This instruction is to be handed to the customer with the filled-in warranty certificate.



Safety Alubar System



Instructions d'emploi Ces instructions d'emploi sont à remettre au client avec le bon de garantie rempli.

Istruzioni per l'uso Il manuale d'uso ed il certificato di garanzia debitamente compilato vanno consegnati cliente.

Instrucciones de uso Este folleto de intrucciones ha de ser entregado al cliente junto con el certificado.

Other languages:
www.fritschi.swiss



Introduction

Congratulations! By purchasing this binding, you have chosen a reliable, quality product that has been TÜV tested to recognized DIN ISO standards. It meets DIN ISO 13992 and 9462. Use only alpine touring and alpine ski boots which meet and fulfil the following DIN ISO standards:

- Alpine touring ski boots for adults DIN ISO 9523
- Alpine boots for adults DIN ISO 5355

Worn or damaged boots may negatively influence the release function. For boots who don't fulfil the mentioned DIN ISO standards (e.g. boots with an ergonomic bellow or TLT-boots), the function is not guaranteed. The bindings must be adjusted by a specialist dealer.

Please read these operating instructions carefully before the first use and keep it in a safe place (warranty certificate).

Safety instructions

Skiing and alpine touring come with unavoidable risks for any skier. Your binding is part of the unit composed of ski, binding and boot. It is not possible to foresee for every situation whether the binding will release or not. It does not always release under all circumstances, and this can result in serious injury with incalculable consequences. No guarantee can be given that the skier will be safe from accidents when it is used. Release bindings considerably reduce the risk of injuries in the area of the lower leg and foot, but not fully. There is no reductive effect on injuries to other parts of the body.

You can influence your own safety when skiing:

- Always ski in a controlled manner and choose alpine tours and descents in accordance with your skills and your physical fitness. Familiarize yourself with the snow and ski run conditions and any obstacles before skiing
- Take heed of warning signs and instructions in the particularly ski area and mind strictly the avalanche and weather forecast.
- Avoid skiing when under the influence of medicines, alcohol or drugs.
- For optimal use of the binding, mounting, adjustment to the boot, the setting of the skiers DIN value and the service of the ski binding must be carried out in accordance with the manufacturer's instructions by a specialist dealer. Improper mounting can impair the bindings function and lead to avoidable injuries. We recommend having the DIN settings adjusted by the specialist dealer using a ski binding adjustment and testing equipment.

Models **Eagle 12** **Scout 11**

DIN value	4–12	3–11
Weight	890g	790g
unit without ski brake		
Ski width	> 70mm	> 70mm

Equipped:

Ski brake 80/90 (/ 100)

Crampon Axion

86mm or 110mm

The most important binding parts

- 1 Toe piece
- 2 Heel piece
- 3 Release lever
- 4 End piece
- 5 Heel elevator (rear support incl.)
- 6 Front plate
- 7 Rear support plate
- 8 Heel damping
- 9 AFD gliding plate
- 10 Mounting screws
- 11 Hinge support
- 12 Central rail
- 13 Ski brake

- If you have purchased this binding on the internet, a specialist dealer must mount and adjust the binding. If any mountings and settings have been made by an unauthorised person, we will not be liable.
- Check your binding each time before use. If any parts are damaged or missing, it should not be used.
- Any alterations to the binding, improper mounting and adjustment or use with incompatible accessories, increase the risk of non-release or defective release.
- The bindings must be mounted directly on the ski (without extraneous components), especially so that the functioning of the ski brakes is not impaired.
- Only use the binding with a corresponding ski brake. Failure to observe this can result in the ski sliding down without breaking after release, endangering people's life and health.
- The braking action of the ski brake is not sufficient in the deep snow.
- Worn or damaged boots can have a negative influence on the release. Get your equipment annually checked by a specialist dealer.
- Settings higher than DIN value 10 are not subject to DIN ISO standards. Settings in these numbers are at your own risk.

Care, storage, warranty

The warranty provided by Fritschi AG Swiss Bindings is given on condition that these operating instructions are observed.

The binding must be checked and if necessary readjusted before each new season by a specialist dealer.

Any repairs must be carried out by a specialist dealer or by the manufacturer.

Care

Remove all kind of material. If the binding is dirty, clean it with a damp cloth or rinse it carefully. If too much water or pressure is used the grease may be rinsed out.

Storage

When storing the binding close the heel unit.

When transported protect the binding from dirt and salt.

After alpine touring and/or skiing, store the skis in a dry and warm room. This prevents the binding mechanism from icing or corrosion.

Warranty

An executed warranty certificate provides consumers with a warranty for 24 months from the date of purchase for any defects that can be shown to be attributable to manufacturing errors or faulty material. The warranty does not apply to rental bindings. The warranty is only valid if work done on the bindings such as mounting, adjusting, adaptation and repairs has been performed by a specialist dealer.

Damage that arises through natural abrasion, excessive or improper use, external influences such as fire, heat, water, etc., through non observance of the instructions, improper care, no or non conform maintenance, are not considered as defects and are, thus, excluded from all warranties.



To exercise the warranty, service is required by a specialist dealer. The defective binding or defective binding parts must be provided to the specialist dealer along with the warranty certificate. Upon receipt, Frittschi AG Swiss Bindings shall decide whether the defective binding is to be repaired or replaced.

Consumer Disclaimer

The binding settings are consistent with the DIN ISO 11088 standard which applies to the mounting, adjusting and testing of the ski binding – ski boot unit. The settings provided by the specialist dealer APPLY ONLY TO THOSE BOOTS FOR WHICH ADJUSTMENTS WERE MADE and may not translate to different pairs of boots than tested by the specialist dealer. Accordingly, you are informed and acknowledge that the adjustments provided by the specialist dealer may not be appropriate for variations in assorted boot configurations.

Place of jurisdiction

Swiss law is applicable to all disputes, and the place of jurisdiction is the head office of Frittschi AG Swiss Bindings. Subject to modifications. Technical data and designs are subject to change at any time without notice.

Register your safety product and increase your warranty to three years instead of two
www.frittschi.swiss

Eagle 12



Grösse / Size / Tailles / Misura / Tallas

Sohlenlänge/sole length/longueur de la semelle/
lunghezza della scuola/longitud de la suela [mm]

SM	260–315
ML	285–340
XL	330–365 Eagle 12 330–370 Scout 11

Scout 11

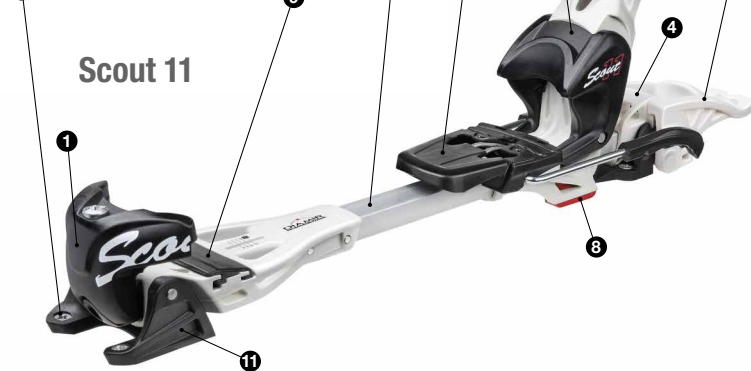

Axion 86/110



Bedienung der Bindung / Operating bindings / Utilisation de la fixation / Impiego dell'attacco / Utilización de la fijación

- 1** Einstieg / Step-in / Chaussage / Calzata / Calzar

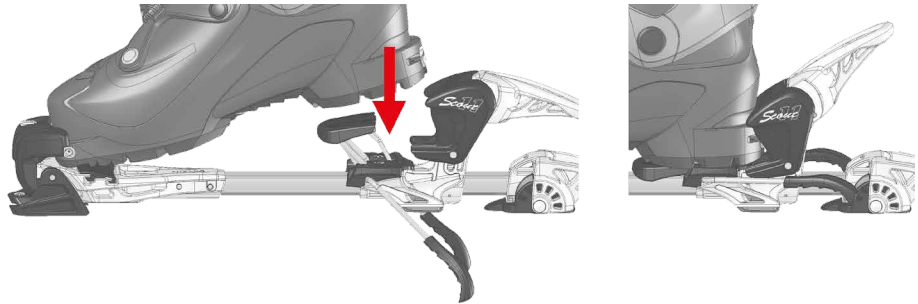

- 2** Ausstieg / Step-out / Déchaussage / Uscita / Descalzar

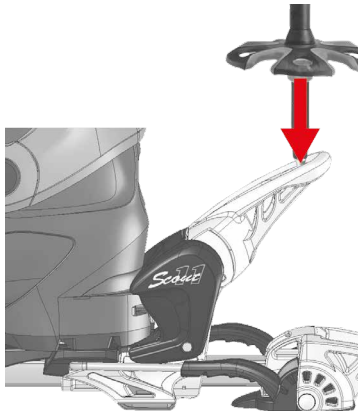

- 3** Umstellung Modus / Switch mode / Passage des modes / Passaggio modalità / Cambio modo

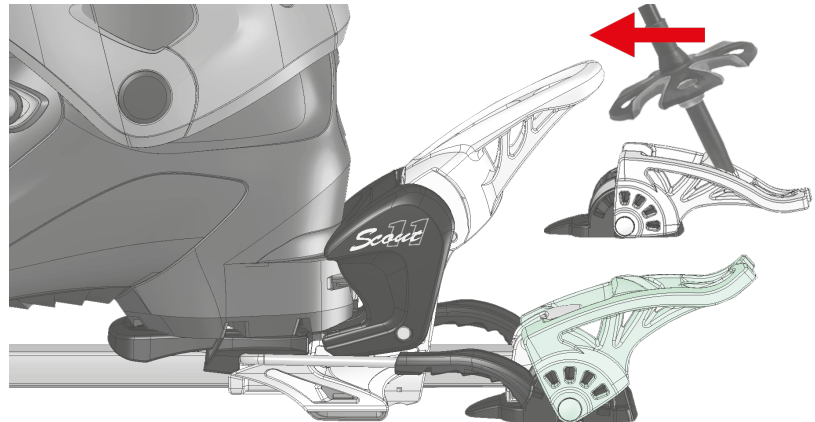

Bedienung der Bindung / Operating bindings / Utilisation de la fixation / Impiego dell'attacco / Utilización de la fijación

- 4 Anpassung Hangneigung / Adaption slope angel / Adaptation l'inclinaison pente / Adeguamento all'inclinazione pendio / Adaptación al ángulo de la pendiente

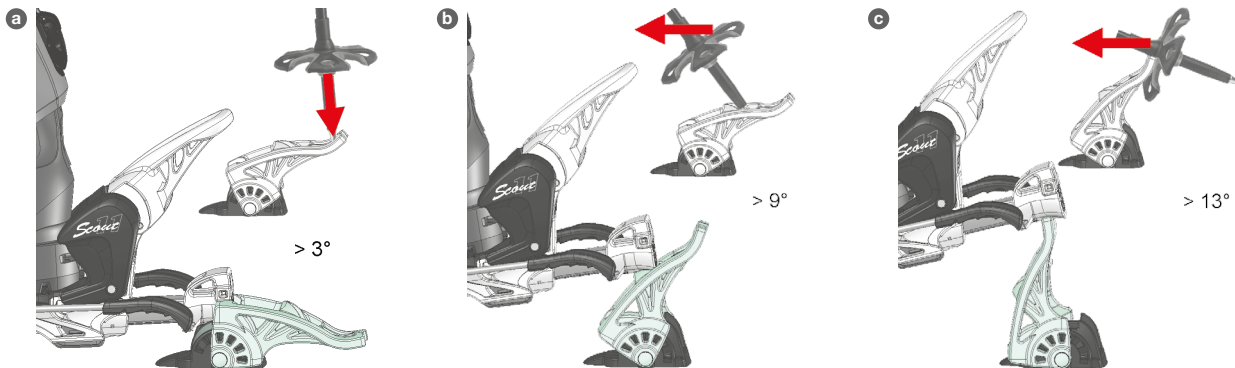

- 5 Fangriemen / Safety leash / Lanière de sécurité / Cinturino di sicurezza / Correa de seguridad

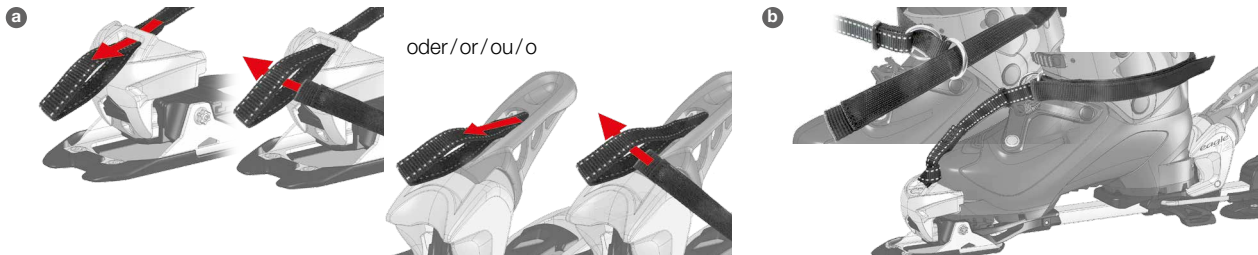

Bedienung der Bindung / Operating bindings / Utilisation de la fixation / Impiego dell'attacco / Utilización de la fijación

6 Fixierung Harscheisen / Fixation the crampon / Accrochage des couteaux / Fissaggio del rampante / Fijación de la cuchilla

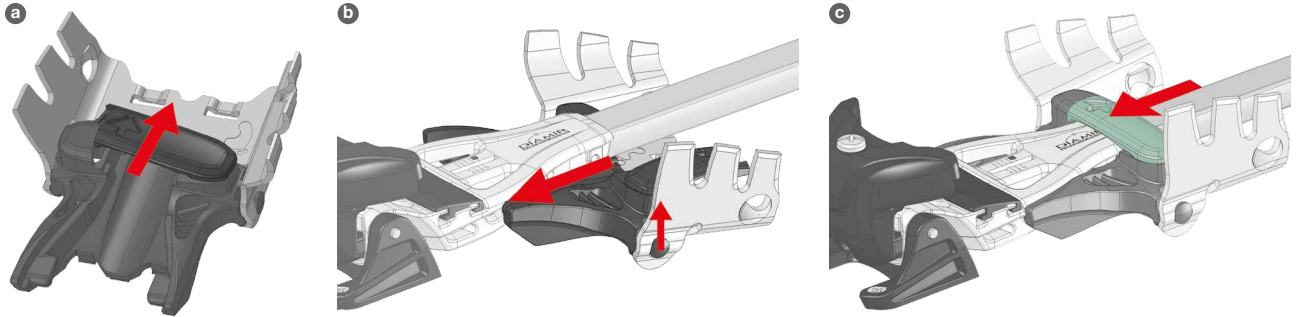

7 Aktivierung (a, b) – Deaktivierung Harscheisen (c) / Activating (a, b) – Deactivating crampon (c) / Activer (a, b) – Deactiver des couteaux à glace (c) / Attivazione (a, b) – Disattivazione del rampante (c) / Activando (a, b) – Desactivando la cuchilla (c)

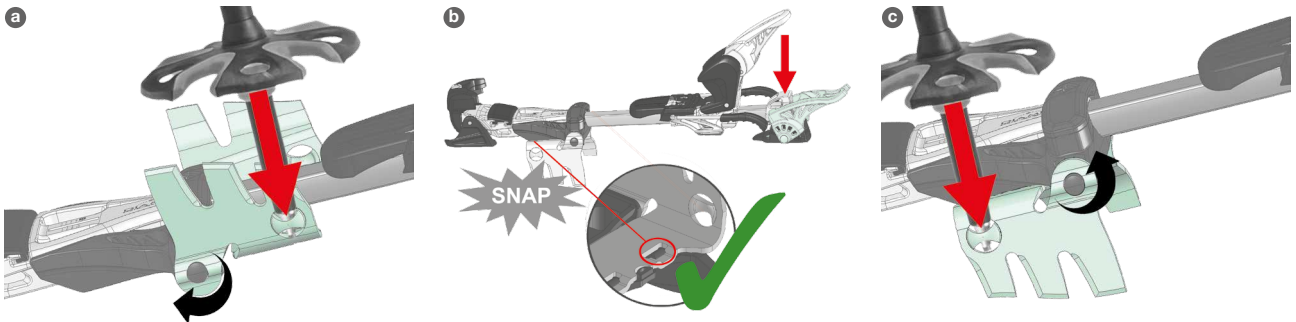

Name Kunde / Customer name / Nom du client / Nome del cliente / Nombre del cliente

Erwerbsdatum / Date of purchase / Date d'achat / Data d'acquisto / Fecha de compra

Seriennummern Bindung / Serial numbers of binding /
Numéros de série de la fixation / Numeros di serie dell'
attacco / Números de serie de la fijación

Jährlicher Bindungscheck: Optimale Funktion der Bindung und somit auch Garantieleistungen können nur mit einer regelmässigen Überprüfung und entsprechender Anpassung gewährleistet werden. Die Bindung muss deshalb vor jeder neuen Saison von einem Fachhändler überprüft und neu eingestellt werden.

Annual binding check: The optimum function of the binding and as a consequence also warranty may only be assured if the system has been checked regularly and adapted accordingly. Therefore the binding must be checked and readjusted before each new season by a specialist dealer.

Contrôle annuel de la fixation: Le fonctionnement optimal de la fixation et en conséquence aussi la garantie ne peuvent qu'être assurés si le système est vérifié régulièrement et ajusté correctement. C'est pourquoi avant chaque nouvelle saison la fixation doit être contrôlée par un revendeur spécialisé.

Controllo annuale dell'attacco: La funzionalità ottimale dell'attacco ed anche la copertura della Garanzia, possono essere garantite solamente se l'attacco viene regolarmente sottoposto a controllo ed a messa a punto. Per questo motivo, l'attacco deve essere controllato e tarato prima di ogni stagione sciistica da un rivenditore.

Revisión anual de la fijación: Tan sólo podemos asegurar el funcionamiento óptimo de la fijación y por tanto de la garantía si el sistema de la fijación se ha revisado regularmente y se adaptado correctamente. Por lo tanto la fijación se debe revisar y reajustar antes de cada nueva temporada por un distribuidor especializado.

Händler (Stempel) / Retailer (stamp) /
Revendeur (cachet) / Rivenditore
(timbro) / Vendedore (sello)

Garantieschein / Warranty certificate / Bulletin de garantie / Certificato di garanzia / Certificado de garantía



Datum / Date / Date / Data / Fecha

Händler / Retailer / Revendeur /
Rivenditore / Vendedor

Stempel / Stamp / Cachet / Timbro / Sello

Bemerkung / Remark / Remarque / Segnalazioni / Comentario

Datum / Date / Date / Data / Fecha

Händler / Retailer / Revendeur /
Rivenditore / Vendedor

Stempel / Stamp / Cachet / Timbro / Sello

Bemerkung / Remark / Remarque / Segnalazioni / Comentario

Datum / Date / Date / Data / Fecha

Händler / Retailer / Revendeur /
Rivenditore / Vendedor

Stempel / Stamp / Cachet / Timbro / Sello

Bemerkung / Remark / Remarque / Segnalazioni / Comentario

Datum / Date / Date / Data / Fecha

Händler / Retailer / Revendeur /
Rivenditore / Vendedor

Stempel / Stamp / Cachet / Timbro / Sello

Bemerkung / Remark / Remarque / Segnalazioni / Comentario

Datum / Date / Date / Data / Fecha

Händler / Retailer / Revendeur /
Rivenditore / Vendedor

Stempel / Stamp / Cachet / Timbro / Sello

Bemerkung / Remark / Remarque / Segnalazioni / Comentario

Datum / Date / Date / Data / Fecha

Händler / Retailer / Revendeur /
Rivenditore / Vendedor

Stempel / Stamp / Cachet / Timbro / Sello

Bemerkung / Remark / Remarque / Segnalazioni / Comentario



Fritschi AG Swiss Bindings

Hauptstrasse 9
CH-3713 Reichenbach

Fon +41 (0)33 672 14 15

Fax +41 (0)33 672 14 10

info@fritschi.swiss

www.fritschi.swiss