



**OPEN** Industry Standard, Flexible Architecture

**GREEN** Less Heat, Less Power Consumption

**STABLE** Robust Design, Quality Parts

Stable and  
Reliable Solution

**Server/Workstation**

Motherboard

**C3758D4I-4L**

**C3558D4I-4L**

**User Manual**

English



Version 1.1

Published December 2017

Copyright©2017 ASRock Rack Inc. All rights reserved.

## Copyright Notice:

No part of this documentation may be reproduced, transcribed, transmitted, or translated in any language, in any form or by any means, except duplication of documentation by the purchaser for backup purpose, without written consent of ASRock Rack Inc.

Products and corporate names appearing in this documentation may or may not be registered trademarks or copyrights of their respective companies, and are used only for identification or explanation and to the owners' benefit, without intent to infringe.

## Disclaimer:

Specifications and information contained in this documentation are furnished for informational use only and subject to change without notice, and should not be constructed as a commitment by ASRock Rack. ASRock Rack assumes no responsibility for any errors or omissions that may appear in this documentation.

With respect to the contents of this documentation, ASRock Rack does not provide warranty of any kind, either expressed or implied, including but not limited to the implied warranties or conditions of merchantability or fitness for a particular purpose.

In no event shall ASRock Rack, its directors, officers, employees, or agents be liable for any indirect, special, incidental, or consequential damages (including damages for loss of profits, loss of business, loss of data, interruption of business and the like), even if ASRock Rack has been advised of the possibility of such damages arising from any defect or error in the documentation or product.



This device complies with Part 15 of the FCC Rules. Operation is subject to the following two conditions:

- (1) this device may not cause harmful interference, and
- (2) this device must accept any interference received, including interference that may cause undesired operation.

## CALIFORNIA, USA ONLY

The Lithium battery adopted on this motherboard contains Perchlorate, a toxic substance controlled in Perchlorate Best Management Practices (BMP) regulations passed by the California Legislature. When you discard the Lithium battery in California, USA, please follow the related regulations in advance.

“Perchlorate Material-special handling may apply, see [www.dtsc.ca.gov/hazardouswaste/perchlorate](http://www.dtsc.ca.gov/hazardouswaste/perchlorate)”

**ASRock Rack's Website: [www.ASRockRack.com](http://www.ASRockRack.com)**

## AUSTRALIA ONLY

Our goods come with guarantees that cannot be excluded under the Australian Consumer Law. You are entitled to a replacement or refund for a major failure and compensation for any other reasonably foreseeable loss or damage caused by our goods. You are also entitled to have the goods repaired or replaced if the goods fail to be of acceptable quality and the failure does not amount to a major failure. If you require assistance please call ASRock Tel : +886-2-28965588 ext.123 (Standard International call charges apply)

## Contact Information

If you need to contact ASRock Rack or want to know more about ASRock Rack, you're welcome to visit ASRock Rack's website at [www.ASRockRack.com](http://www.ASRockRack.com); or you may contact your dealer for further information.

### **ASRock Rack Incorporation**

6F., No.37, Sec. 2, Jhongyang S. Rd., Beitou District,  
Taipei City 112, Taiwan (R.O.C.)

## Contents

<b>Chapter 1 Introduction</b>	<b>1</b>
1.1 Package Contents	1
1.2 Specifications	2
1.3 Unique Features	5
1.4 Motherboard Layout	6
1.5 Onboard LED Indicators	9
1.6 I/O Panel	10
1.7 Block Diagram	12
<b>Chapter 2 Installation</b>	<b>13</b>
2.1 Screw Holes	13
2.2 Pre-installation Precautions	13
2.3 Installation of Memory Modules (DIMM)	14
2.4 Expansion Slots (PCI Express Slot)	16
2.5 Jumper Setup	17
2.6 Onboard Headers and Connectors	19
2.7 Unit Identification purpose LED/Switch	25
2.8 Driver Installation Guide	25
2.9 Dual LAN and Teaming Operation Guide	26
<b>Chapter 3 UEFI Setup Utility</b>	<b>27</b>
3.1 Introduction	27
3.1.1 UEFI Menu Bar	27
3.1.2 Navigation Keys	28
3.2 Main Screen	29

3.3	Advanced Screen	30
3.3.1	CPU Configuration	31
3.3.2	DRAM Configuration	33
3.3.3	Chipset Configuration	34
3.3.4	Storage Configuration	36
3.3.5	ACPI Configuration	38
3.3.6	USB Configuration	39
3.3.7	Super IO Configuration	40
3.3.8	Serial Port Console Redirection	41
3.3.9	H/W Monitor	44
3.3.10	System Event Log	46
3.3.11	Intel SPS Configuration	48
3.3.12	Instant Flash	49
3.4	Security Screen	50
3.4.1	Secure Boot	51
3.4.2	Key Management	52
3.5	Boot Screen	56
3.5.1	CSM (Compatibility Support Module)	58
3.6	Event Logs Screen	59
3.7	Server Mgmt Screen	61
3.7.1	System Event Log	62
3.7.2	BMC Network Configuration	63
3.8	Exit Screen	65

<b>Chapter 4 Software Support</b>	<b>66</b>
4.1 Install Operating System	66
4.2 Support CD Information	66
4.2.1 Running The Support CD	66
4.2.2 Drivers Menu	66
4.2.3 Utilities Menu	66
4.2.4 Contact Information	66
<b>Chapter 5 Troubleshooting</b>	<b>67</b>
5.1 Troubleshooting Procedures	67
5.2 Technical Support Procedures	69
5.3 Returning Merchandise for Service	69

# Chapter 1 Introduction

Thank you for purchasing ASRock Rack **C3758D4I-4L / C3558D4I-4L** motherboard, a reliable motherboard produced under ASRock Rack's consistently stringent quality control. It delivers excellent performance with robust design conforming to ASRock Rack's commitment to quality and endurance.

In this manual, chapter 1 and 2 contains introduction of the motherboard and step-by-step guide to the hardware installation. Chapter 3 and 4 contains the configuration guide to BIOS setup and information of the Support CD.



*Because the motherboard specifications and the BIOS software might be updated, the content of this manual will be subject to change without notice. In case any modifications of this manual occur, the updated version will be available on ASRock Rack website without further notice. You may find the latest memory and CPU support lists on ASRock Rack website as well. ASRock Rack's Website: [www.ASRockRack.com](http://www.ASRockRack.com)*

*If you require technical support related to this motherboard, please visit our website for specific information about the model you are using.  
<http://www.asrockrack.com/support/>*

## 1.1 Package Contents

- ASRock Rack C3758D4I-4L / C3558D4I-4L Motherboard  
(Mini-ITX Form Factor: 6.7-in x 6.7-in, 17.02 cm x 17.02 cm)
- Support CD
- Quick Installation Guide
- 1 x I/O Shield
- 2 x Mini SAS HD to 4 SAS/SATA Cables (12G)
- 2 x SATA3 Cables (6G) (60cm)
- 1 x SATA Power Cable (4PIN TO 15 PIN\*6)



*If any items are missing or appear damaged, contact your authorized dealer.*

## 1.2 Specifications

<b>C3758D4I-4L / C3558D4I-4L</b>	
<b>MB Physical Status</b>	
Form Factor	Mini ITX
Dimension	6.7" x 6.7" (17.02 cm x 17.02 cm)
<b>Processor System</b>	
CPU	<b>C3758D4I-4L:</b> Intel® Atom C3758 Series Processor: 8core, 25W <b>C3558D4I-4L:</b> Intel® Atom C3558 Series Processor: 4core, 16W
Chipset	Soc
<b>System Memory</b>	
Capacity	- 4 x 288-pin DDR4 DIMM slots - Support up to 128GB DDR4 RDIMM (32 GB w/8Gb DRAM) - Support up to 64GB DDR4 UDIMM (16 GB w/8Gb DRAM)
DIMM Sizes and Type per DIMM	- Dual Channel DDR4 memory technology - Non-ECC, ECC UDIMM: 4GB, 8GB, 16GB - RDIMM: 4GB, 8GB, 16GB, 32GB
Frequency	- Non-ECC UDIMM: 1600/1866/2133/2400* MHz - ECC UDIMM: 1600/1866/2133/2400* MHz - RDIMM: 1600/1866/2133/2400* MHz <i>*Only C3758D4I-4L supports DDR4 up to 2400.</i>
Voltage	1.2V
<b>Expansion Slot</b>	
PCIe 3.0 x8	1 x PCIe MEx8 / EE x8 (MAX x8 by BIOS setup)
<b>Storage</b>	
SATA Controller	<b>C3758D4I-4L:</b> 13 x SATA3 6.0 Gb/s, 8x SATA ports from 2x mini SAS HD connectors <b>C3558D4I-4L:</b> 5 x SATA3 6.0 Gb/s, 4x SATA ports from 1x mini SAS HD connectors (Max 8 ports by BIOS setting)
<b>Ethernet</b>	
Interface	Gigabit LAN 10/100/1000 Mb/s
LAN Controller	- Marvell 88E1543(4L) - Supports Wake-On-LAN - Supports Energy Efficient Ethernet 802.3az - Supports Dual LAN with Teaming function - Supports PXE - LAN1 Supports NCSI



Management	
BMC Controller	ASPEED AST2500 : IPMI (Intelligent Platform Management Interface) 2.0 with Ikmv and vMedia support
IPMI Dedicated GLAN	1 x Realtek RTL8211E for dedicated management LAN
Features	- Watch Dog - NMI
Graphics	
Controller	ASPEED AST2500
VRAM	DDR4 64MB
Output	Supports D-Sub with max. resolution up to 1920x1200 @ 60Hz
Rear Panel I/O	
VGA Port	1 x D-sub
USB 3.0 Port	2
LAN Port	- 4 x RJ45 Gigabit Ethernet LAN ports - 1 x RJ45 Dedicated IPMI LAN port - LAN Ports with LED (ACT/LINK LED and SPEED LED)
UID Button/UID LED	1
Serial port	1
Internal Connector	
Auxiliary Panel Header	1 (includes chassis intrusion , location button & LED , front LAN LED, and event log LED)
TPM Header	1
IPMB Header	1
Fan Header	4 pins x4 (1CPU/2Front/1Rear)
ATX Power	1 (24-pin)
DC-IN	1 (8-pin) 12v
SATA POWER	1 (4-pin)
Front Panel	1
USB 2.0 Header	1
System BIOS	
BIOS Type	128Mb AMI UEFI Legal BIOS
BIOS Features	- Plug and Play (PnP) - ACPI 1.1 Compliance Wake Up Events - SMBIOS 2.3.1 Support - DRAM Voltage Multi-adjustment - ASRock Instant Flash
Hardware Monitor	
Temperature	- CPU/PCH/DDR/LAN/Storage Temperature Sensing - MB/Card side/TR1 Temperature Sensing

Fan	<ul style="list-style-type: none"> <li>- CPU/Rear/Front Fan Tachometer</li> <li>- CPU Quiet Fan (Allow CPU Fan Speed Auto-Adjust by CPU Temperature)</li> <li>- CPU/Rear/Front Fan Multi-Speed Control</li> </ul>
Voltage	Voltage Monitoring: +12V, +5V, +3.3V, CPU Vcore, DRAM, +BAT, 3VSB, 5VSB
<b>Support OS</b>	
OS	<p>Microsoft® Windows®</p> <ul style="list-style-type: none"> <li>- Server 2016 (64 bit)</li> <li>- Server 2012 (64 bit)</li> <li>- Server 2012 R2 (64 bit)</li> </ul> <p>Linux</p> <ul style="list-style-type: none"> <li>- RedHat Enterprise Linux Server 6.8 (32 / 64 bit) / 7.2 (64 bit)</li> <li>- CentOS 6.8 (32 / 64 bit) / 7.2 (64 bit)</li> <li>- SUSE Enterprise Linux Server 11 SP4 (32 / 64 bit) / 12 SP1 (64 bit)</li> <li>- Fedora core 24 (64 bit)</li> <li>- Ubuntu 16.04 (64 bit) / 15.10 (64 bit) (AHCI mode)</li> </ul> <p>Virtual</p> <ul style="list-style-type: none"> <li>- VMWare ESXi 6.0</li> </ul> <p>* Please refer to our website for the latest OS support list.</p>
<b>Environment</b>	
Temperature	<p>Operation temperature: 10°C ~ 35°C / Non operation temperature: -40°C ~ 70°C</p> <p><i>* Install a CPU Fan when the airflow through the heatsink is below 2CFM.</i></p>

\* For detailed product information, please visit our website: <http://www.asrockrack.com>



This motherboard supports Wake from on Board LAN. To use this function, please make sure that the "Wake on Magic Packet from power off state" is enabled in Device Manager > Intel® Ethernet Connection > Power Management. And the "PCI Devices Power On" is enabled in UEFI SETUP UTILITY > Advanced > ACPI Configuration. After that, onboard LAN1&2 can wake up S5 under OS.



If you install Intel® LAN utility or Marvell SATA utility, this motherboard may fail Windows® Hardware Quality Lab (WHQL) certification tests. If you install the drivers only, it will pass the WHQL tests.

## 1.3 Unique Features

ASRock Instant Flash is a BIOS flash utility embedded in Flash ROM. This convenient BIOS update tool allows you to update system BIOS without entering operating systems first like MS-DOS or Windows<sup>®</sup>. With this utility, you can press the <F6> key during the POST or the <F2> key to enter into the BIOS setup menu to access ASRock Rack Instant Flash. Just launch this tool and save the new BIOS file to your USB flash drive, floppy disk or hard drive, then you can update your BIOS only in a few clicks without preparing an additional floppy diskette or other complicated flash utility. Please be noted that the USB flash drive or hard drive must use FAT32/16/12 file system.

# 1.4 Motherboard Layout

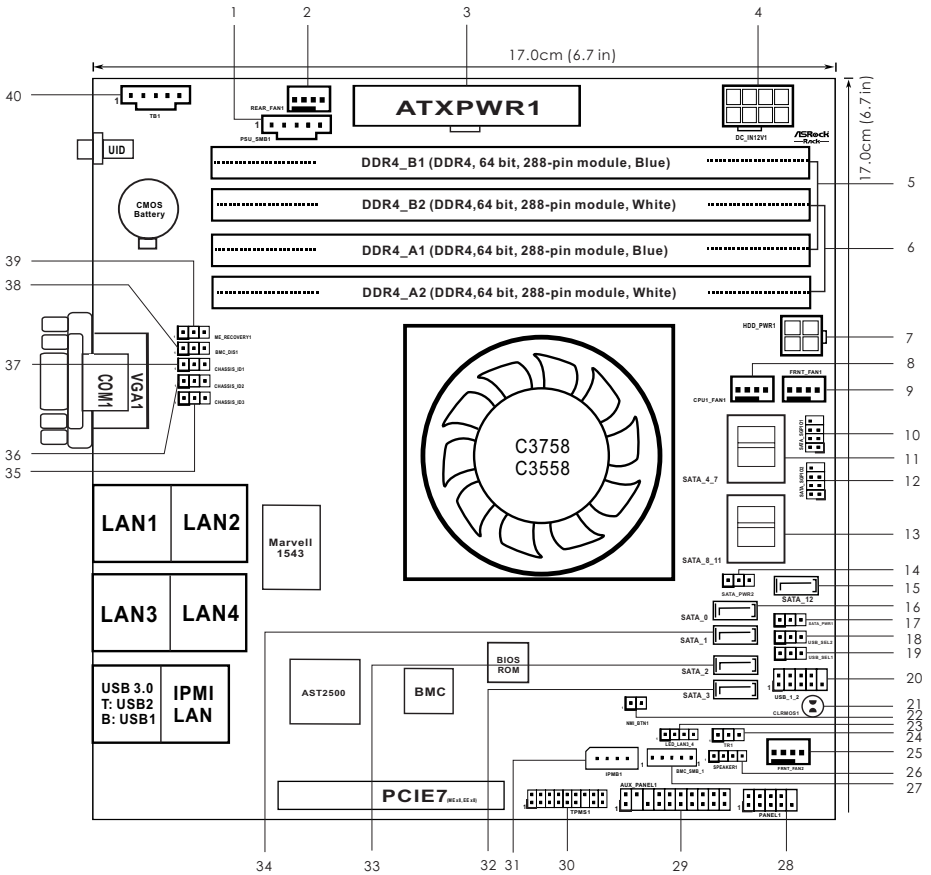

No.	Description
1	PSU SMBus (PSU_SMB1)
2	Rear Fan Connector (REAR_FAN1)
3	ATX Power Connector (ATXPWR1)*
4	ATX 12V Power Connector (DC_IN12V1)*
5	2 x 288-pin DDR4 DIMM Slots (DDR4_A1 DDR4_B1)
6	2 x 288-pin DDR4 DIMM Slots (DDR4_A2, DDR4_B2)
7	HDD Power Connector (HDD_PWR1)
8	CPU Fan Connector (CPU1_FAN1)
9	Front Fan Connector (FRNT_FAN1)
10	SATA SGPIO Connector (SATA_SGPIO1)
11	Mini SAS HD Connector (SATA_4_7)
12	SATA SGPIO Connector (SATA_SGPIO2)
13	Mini SAS HD Connector (SATA_8_11)
14	SATA DOM Power Jumper (SATA_PWR1)
15	SATA3 DOM Connector (SATA_12), Red
16	SATA3 DOM Connector (SATA_0), Red
17	SATA DOM Power Jumper (SATA_PWR1)
18	USB Selection Jumper (USB_SEL2)
19	USB Selection Jumper (USB_SEL1)
20	USB 2.0 Header (USB_1_2)**
21	Clear CMOS Pad (CLRMOS1)
22	Non Maskable Interrupt Button (NMI_BTN1)
23	LAN LED Connector (LED_LAN3_4)
24	Thermal Sensor Header (TR1)
25	Front Fan Connector (FRNT_FAN2)
26	Speaker Header (SPEAKER1)
27	BMC SMB Header (BMC_SMB1)
28	System Panel Header (PANEL1)
29	Auxiliary Panel Header (AUX_PANEL1)
30	TPMS Header (TPMS1)
31	Intelligent Platform Management Bus header (IPMB1)
32	SATA3 Connector (SATA_3), White
33	SATA3 Connector (SATA_2), White

No.	Description
34	SATA3 Connector (SATA_1), White
35	Chassis ID Jumper (CHASSIS_ID3)
36	Chassis ID Jumper (CHASSIS_ID2)
37	Chassis ID Jumper (CHASSIS_ID1)
38	Enable/Disable BMC Jumper (BMC_DIS1)
39	ME Recovery Jumper (ME_RECOVERY1)
40	Thunderbolt AIC Connector (TB1)

*\*Please use either the ATX 12V Power Connector (DC\_IN12V1) or the ATX Power Connector (ATXPWR1) at one time. Do not connect them both simultaneously.*

*\*\* The USB3\_2 port on the rear I/O is shared with the USB\_1\_2 header on the motherboard. Please refer to p.18 for jumper setup information.*

## 1.5 Onboard LED Indicators

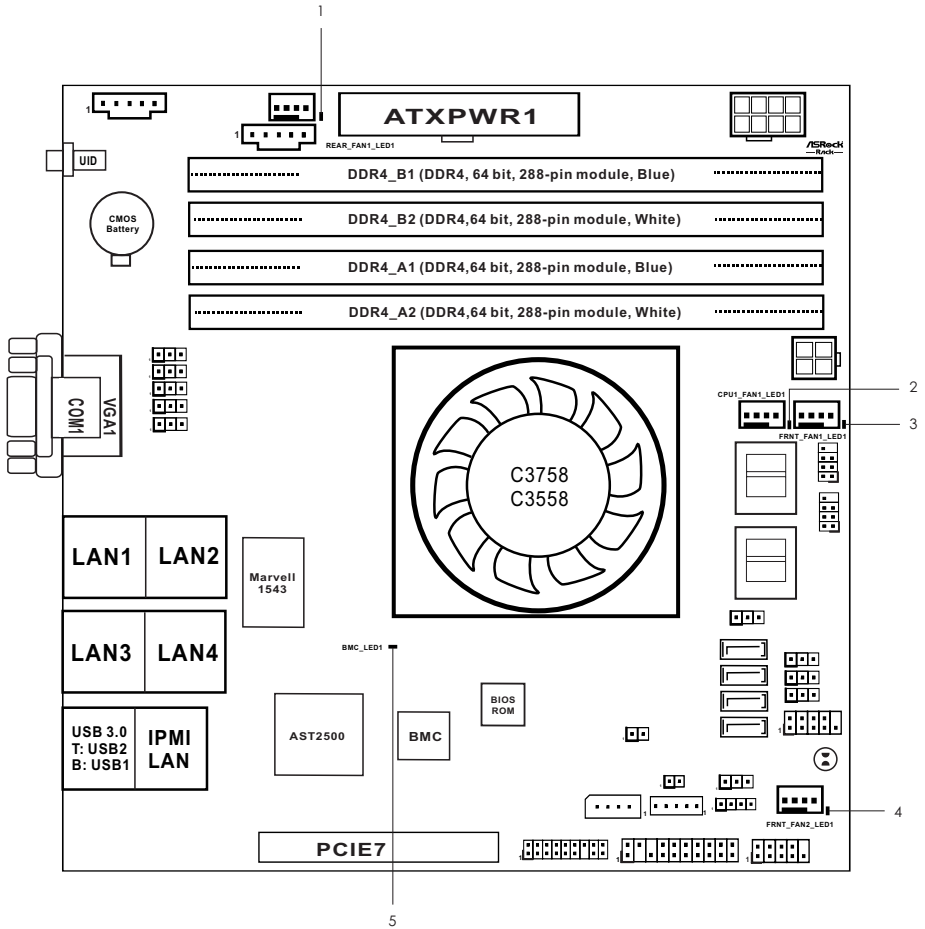

No.	Status	Description
1	Amber	REAR_FAN1 failed
2	Amber	CPU_FAN1 failed
3	Amber	FRNT_FAN1 failed
4	Amber	FRNT_FAN2 failed
5	Green	BMC heartbeat LED

## 1.6 I/O Panel

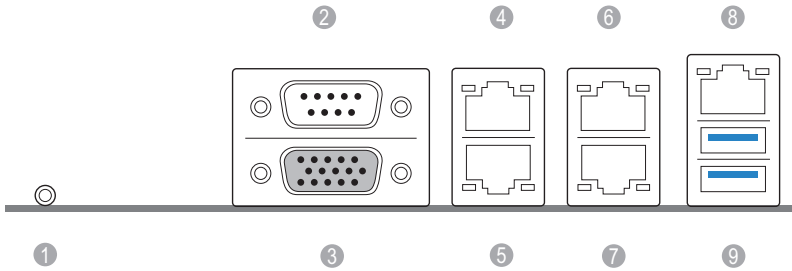

No.	Description	No.	Description
1	UID Switch (UID)	6	LAN RJ-45 Port (LAN4)**
2	COM Port (COM1)	7	LAN RJ-45 Port (LAN3)**
3	VGA Port (VGA1)	8	Dedicated IPMI LAN Port*
4	LAN RJ-45 Port (LAN2)**	9	USB 3.0 Ports (USB3_12)***
5	LAN RJ-45 Port (LAN1)**		

### LAN Port LED Indications

\*There are two LED next to the LAN port. Please refer to the table below for the LAN port LED indications.

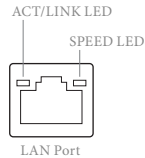

### Dedicated IPMI LAN Port LED Indications

Activity / Link LED		Speed LED	
Status	Description	Status	Description
Off	No Link	Off	No Link
Blinking Yellow	Data Activity	Off	10M bps connection
On	Link	Yellow	100M bps connection
		Green	1G bps connection



\*\*There are two LEDs on each LAN port. Please refer to the table below for the LAN port LED indications.

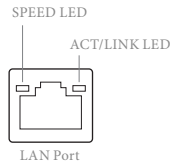

#### LAN Port (LAN1, LAN2, LAN3, LAN4) LED Indications

Speed LED		Activity / Link LED	
Status	Description	Status	Description
Off	10Mbps connection or no link	Off	No Link
Yellow	100Mbps connection	Blinking Green	Data Activity
Green	1Gbps connection	On	Link

\*\*\* The USB3\_2 port on the rear I/O is shared with the USB\_1\_2 header on the motherboard. Please refer to p.18 for jumper setup information.

# 1.7 Block Diagram

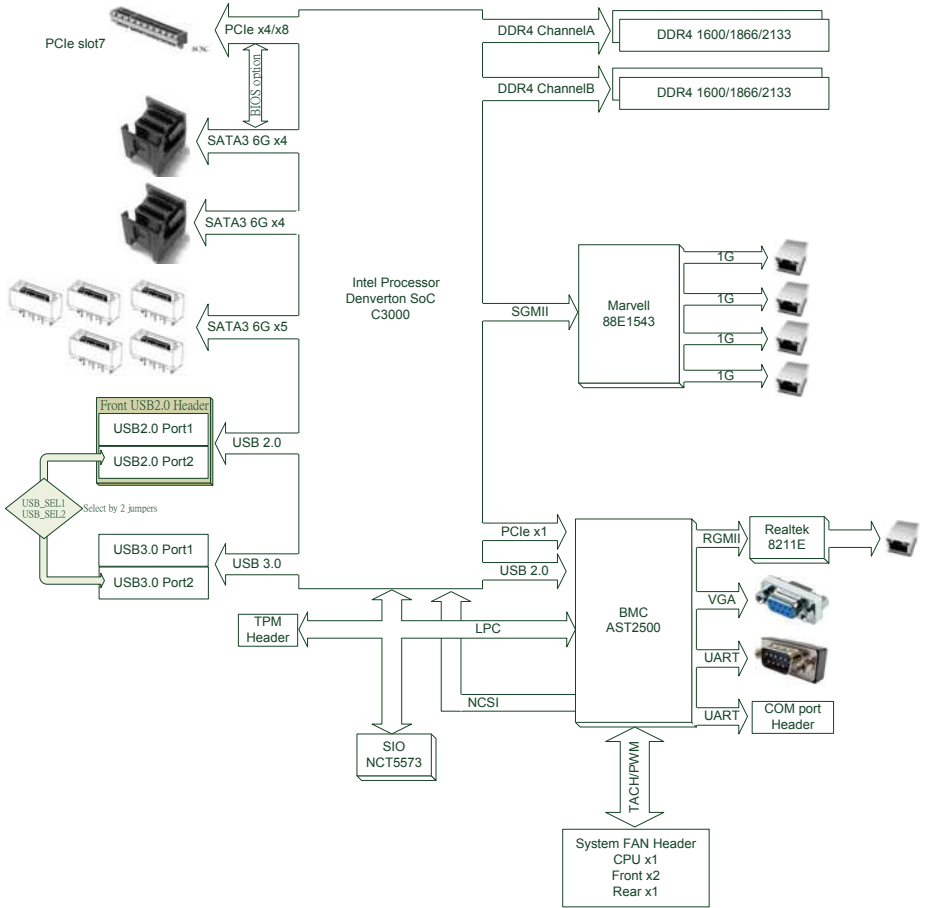

## Chapter 2 Installation

This is a Mini-ITX form factor (6.7" x 6.7", 17.0 cm x 17.0 cm) motherboard. Before you install the motherboard, study the configuration of your chassis to ensure that the motherboard fits into it.



*Make sure to unplug the power cord before installing or removing the motherboard. Failure to do so may cause physical injuries to you and damages to motherboard components.*

### 2.1 Screw Holes

Place screws into the holes indicated by circles to secure the motherboard to the chassis.



*Do not over-tighten the screws! Doing so may damage the motherboard.*

### 2.2 Pre-installation Precautions

Take note of the following precautions before you install motherboard components or change any motherboard settings.

1. Unplug the power cord from the wall socket before touching any components.
2. To avoid damaging the motherboard's components due to static electricity, NEVER place your motherboard directly on the carpet or the like. Also remember to use a grounded wrist strap or touch a safety grounded object before you handle the components.
3. Hold components by the edges and do not touch the ICs.
4. Whenever you uninstall any component, place it on a grounded anti-static pad or in the bag that comes with the component.
5. When placing screws into the screw holes to secure the motherboard to the chassis, please do not over-tighten the screws! Doing so may damage the motherboard.



*Before you install or remove any component, ensure that the power is switched off or the power cord is detached from the power supply. Failure to do so may cause severe damage to the motherboard, peripherals, and/or components.*

## 2.3 Installation of Memory Modules (DIMM)

This motherboard provides four 288-pin DDR4 (Double Data Rate 4) DIMM slots, and supports Dual Channel Memory Technology.



1. For dual channel configuration, you always need to install identical (the same brand, speed, size and chip-type) DDR4 DIMM pairs.
2. It is not allowed to install a DDR, DDR2 or DDR3 memory module into a DDR4 slot; otherwise, this motherboard and DIMM may be damaged.
3. Please install the memory module on CH0\_A1 for the first priority.
4. To activate Dual Channel Memory Technology, please follow the "Dual Channel Memory Configuration" table below.

### Dual Channel Memory Configuration

Priority	DDR4_A1 (Blue)	DDR4_A21 (White)	DDR4_B1 (Blue)	DDR4_B2 (White)
1	Populated		Populated	
2	Populated	Populated	Populated	Populated

*\*Since installing three memory modules is NOT supported on this motherboard, we suggest not using this configuration.*



*The DIMM only fits in one correct orientation. It will cause permanent damage to the motherboard and the DIMM if you force the DIMM into the slot at incorrect orientation.*

1

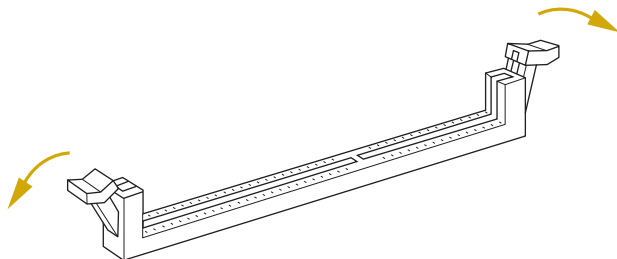

2

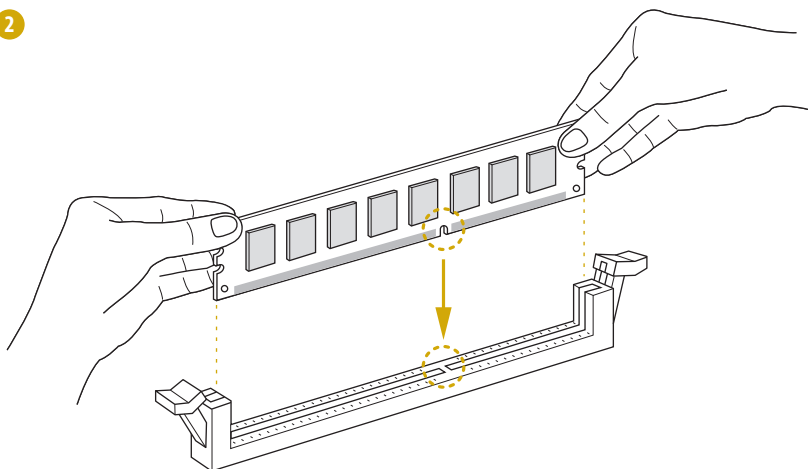

3

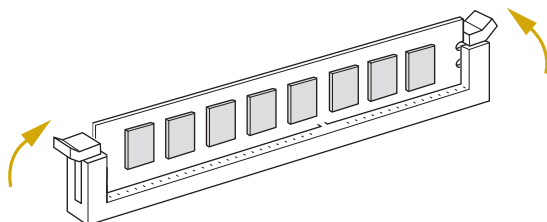

## 2.4 Expansion Slots (PCI Express Slot)

There is 1 PCI Express slot on this motherboard.

### PCIe slot:

PCIe7 (PCIe 3.0 x8 slot) is used for PCI Express max x8 lane width cards.

Slot	Generation	Mechanical	Electrical	Source
PCIe 7	3.0	x8	x8 / x4	CPU







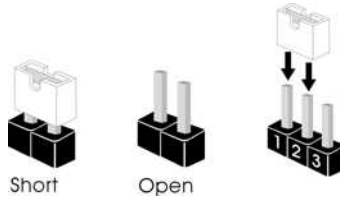

### Installing an expansion card

- Step 1. Before installing an expansion card, please make sure that the power supply is switched off or the power cord is unplugged. Please read the documentation of the expansion card and make necessary hardware settings for the card before you start the installation.
- Step 2. Remove the system unit cover (if your motherboard is already installed in a chassis).
- Step 3. Remove the bracket facing the slot that you intend to use. Keep the screws for later use.
- Step 4. Align the card connector with the slot and press firmly until the card is completely seated on the slot.
- Step 5. Fasten the card to the chassis with screws.
- Step 6. Replace the system cover.



## 2.5 Jumper Setup

The illustration shows how jumpers are setup. When the jumper cap is placed on the pins, the jumper is “Short”. If no jumper cap is placed on the pins, the jumper is “Open”. The illustration shows a 3-pin jumper whose pin1 and pin2 are “Short” when a jumper cap is placed on these 2 pins.





ME Recovery Jumper (3-pin ME_RECOVERY1) (see p.6, No. 39)	<b>1_2</b>  Normal Mode (Default)	<b>2_3</b>  ME Recovery Mode
Chassis ID1 Jumper (3-pin CHASSIS_ID1) (see p.6, No. 37)	<b>1_2</b>  Single mother board indication (Default)	<b>2_3</b>  System level
Chassis ID2 Jumper (3-pin CHASSIS_ID2) (see p.6, No. 38)		
Chassis ID3 Jumper (3-pin CHASSIS_ID3) (see p.6, No. 35)		
Enable/Disable BMC Jumper (3-pin BMC_DIS1) (see p.6, No. 38)	<b>1_2</b>  Normal Mode (Default) BMC Enabled	<b>2_3</b>  BMC Disabled
SATA DOM Power Jumper 1 (3-pin SATA_PWR1) (see p.6, No. 17)	<b>1_2</b>  SATA DOM (SATA_0) requires 5V power supply	<b>2_3</b>  Normal SATA (Default) SATA DOM (SATA_0) does NOT require 5V power supply

---

<p>SATA DOM Power Jumper 2 (3-pin SATA_PWR2) (see p.6, No. 14)</p>	<p><b>1_2</b></p> 	<p><b>2_3</b></p> 
	<p>SATA DOM (SATA_12) requires 5V power supply</p>	<p>Normal SATA (Default) SATA DOM (SATA_12) does NOT require 5V power supply</p>

---

<p>USB Selection Jumpers (3-pin USB_SEL1) (see p.6, No. 19) (3-pin USB_SEL2) (see p.6, No. 18)</p>	<p><b>1_2</b></p> 	<p><b>2_3</b></p> 
	<p>1. USB3_2 on the Rear I/O supports USB3.0 and USB2.0. 2. USB_1_2 header supports Port 1 only. (Default)</p>	<p>1. USB3_2 on the Rear I/O supports USB3.0 only. 2. USB_1_2 header supports Port 1 and Port 2.</p>

---



## 2.6 Onboard Headers and Connectors



Onboard headers and connectors are NOT jumpers. Do NOT place jumper caps over these headers and connectors. Placing jumper caps over the headers and connectors will cause permanent damage to the motherboard.

\*Please refer to page 6 or 8 for the motherboard layout.

Mini SAS HD  
Connectors\*  
(SATA\_4\_7)  
(see p.6, No. 11)  
(SATA\_8\_11)  
(see p.6, No. 13)



These Mini SAS HD connectors support SAS/SATA data cables for internal storage devices. The current SAS3/SATA3 interface allows up to 12.0 Gb/s data transfer rate. For connecting SAS HDDs, please contact SAS data cable dealers.

Serial ATA3 Connectors  
(SATA\_0)  
(see p.6, No. 16)  
(SATA\_1)  
(see p.6, No. 34)  
(SATA\_2)  
(see p.6, No. 33)  
(SATA\_3)  
(see p.6, No. 32)

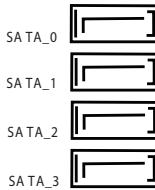

These four SATA3 connectors support SATA data cables for internal storage devices with up to 6.0 Gb/s data transfer rate.

Serial ATA3 DOM  
Connector  
(SATA\_0)  
(see p.6, No. 16)  
(SATA\_12)  
(see p.6, No. 15)



The SATA3 DOM connector supports both a SATA DOM (Disk-On-Module) and a SATA data cable for internal storage device.

Chassis Speaker Header  
(4-pin SPEAKER1)  
(see p.6, No. 26)

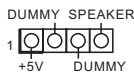

Please connect the chassis speaker to this header.

TPMS Header  
(17-pin TPMS1)  
(see p.6, No. 30)

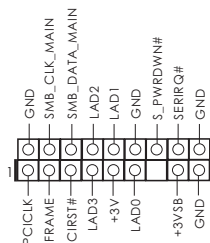

This connector supports Trusted Platform Module (TPM) system, which can securely store keys, digital certificates, passwords, and data. A TPM system also helps enhance network security, protects digital identities, and ensures platform integrity.

Serial General Purpose  
Input/Output Headers  
(7-pin SATA\_SGPIO1)  
(see p.6, No. 10)  
(7-pin SATA\_SGPIO2)  
(see p.6, No. 12)

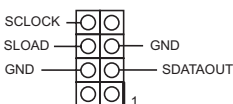

These headers support Serial Link interface for onboard SATA connections.

PSU SMBus  
(PSU\_SMB1)  
(see p.6, No. 1)

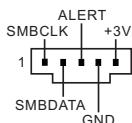

PSU SMBus monitors the status of the power supply, fan and system temperature.

BMC SMB Headers  
(5-pin BMC\_SMB\_1)  
(see p.6, No. 27)

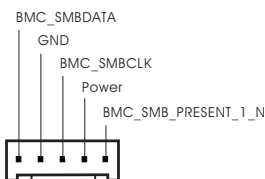

This header is used for the SMBUS devices.

Non Maskable Interrupt  
Button Header  
(2-pin NMI\_BTN1)  
(see p.6, No. 22)



Please connect a NMI device to this header.

**System Panel Header**  
(9-pin PANEL1)  
(see p.6, No. 28)

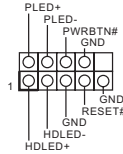

This header accommodates several system front panel functions.



**PWRBTN (Power Switch):**

Connect to the power switch on the chassis front panel. You may configure the way to turn off your system using the power switch.

**RESET (Reset Switch):**

Connect to the reset switch on the chassis front panel. Press the reset switch to restart the computer if the computer freezes and fails to perform a normal restart.

**PLED (System Power LED):**

Connect to the power status indicator on the chassis front panel. The LED is on when the system is operating. The LED is off when the system is in powered off (S5).

**HDLED (Hard Drive Activity LED):**

Connect to the hard drive activity LED on the chassis front panel. The LED is on when the hard drive is reading or writing data.

The front panel design may differ by chassis. A front panel module mainly consists of power switch, reset switch, power LED, hard drive activity LED, speaker and etc. When connecting your chassis front panel module to this header, make sure the wire assignments and the pin assignments are matched correctly.

**ATX Power Connector**  
(24-pin ATXPWR1)  
(see p.6, No. 3)

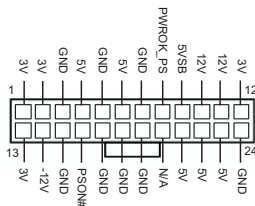

Please connect an ATX power supply to this connector.

Though this motherboard provides a 24-pin ATX power connector, it can still work if you adopt a traditional 20-pin ATX power supply. To use a 20-pin ATX power supply, please plug your power supply along Pin 1 and Pin 13.

**ATX 12V Power Connector**  
(8-pin DC\_IN12V1)  
(see p.6, No. 4)

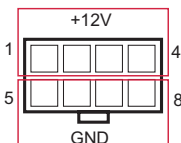

This motherboard provides one 8-pin ATX 12V power connector.

**Auxiliary Panel Header**  
(18-pin AUX\_PANEL1)  
(see p.6, No. 29)

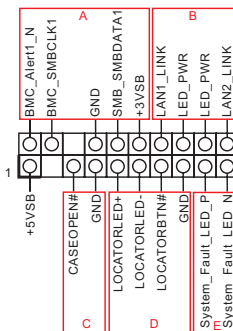

This header supports multiple functions on the front panel, including front panel SMB, internet status indicator.



**A. Front panel SMBus connecting pin (6-1 pin FPSMB)**

This header allows you to connect SMBus (System Management Bus) equipment. It can be used for communication between peripheral equipment in the system, which has slower transmission rates, and power management equipment.

**B. Internet status indicator (2-pin LAN1\_LED, LAN2\_LED)**

These two 2-pin headers allow you to use the Gigabit internet indicator cable to connect to the LAN status indicator. When this indicator flickers, it means that the internet is properly connected.

**C. Chassis intrusion pin (2-pin CHASSIS)**

This header is provided for host computer chassis with chassis intrusion detection designs. In addition, it must also work with external detection equipment, such as a chassis intrusion detection sensor or a microswitch. When this function is activated, if any chassis component movement occurs, the sensor will immediately detect it and send a signal to this header, and the system will then record this chassis intrusion event. The default setting is set to the CASEOPEN and GND pin; this function is off.

**D. Locator LED (4-pin LOCATOR)**

This header is for the locator switch and LED on the front panel.

**E. System Fault LED (2-pin LOCATOR)**

This header is for the Fault LED on the system.

**Front and Rear Fan Connectors**  
(4-pin FRNT\_FAN1)  
(see p.6, No. 9)  
(4-pin FRNT\_FAN2)  
(see p.6, No. 25)  
(4-pin REAR\_FAN1)  
(see p.6, No. 2)

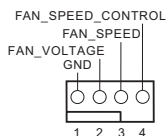

Please connect the fan cables to the fan connectors and match the black wire to the ground pin. All fans supports Fan Control.

CPU Fan Connector  
(4-pin CPU1\_FAN1)  
(see p.6, No. 8)

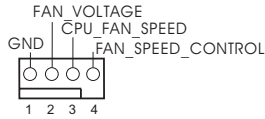

Please connect the CPU fan cable to the connector and match the black wire to the ground pin.

Though this motherboard provides a 4-Pin CPU fan (Quiet Fan) connector, 3-Pin CPU fans can still work successfully even without the fan speed control function. If you plan to connect a 3-Pin CPU fan to the CPU fan connector on this motherboard, please connect it to Pin 1-3.

*\*For more details, please refer to the Cooler QVL list on the ASRock Rack website.*

HDD Power Connector  
(4-pin HDD\_PWR1)  
(see p.6, No. 7)

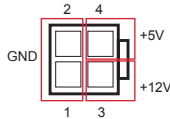

Please connect a 4-pin power cable to this connector to connect a HDD.

Intelligent Platform  
Management Bus header  
(4-pin IPMB1)  
(see p.6, No. 31)

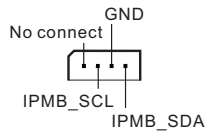

This 4-pin connector is used to provide a cabled baseboard or front panel connection for value added features and 3rd-party add-in cards, such as Emergency Management cards, that provide management features using the IPMB.

---

LAN LED Connector  
(LED\_LAN3\_4)  
(see p.6, No. 23)

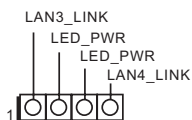

This 4-pin connector is used for the front LAN status indicator.

---

Thermal Sensor Header  
(3-pin TR1)  
(see p.6, No. 24)



Please connect the thermal sensor cable to either pin 1-2 or pin 2-3 and the other end to the device which you wish to monitor its temperature.

---

Clear CMOS Pad  
(CLRMO51)  
(see p.6, No. 21)



CLRMO51 allows you to clear the data in CMOS. To clear CMOS, take out the CMOS battery and short the Clear CMOS Pad.

---

Thunderbolt AIC Connector  
(5-pin TB1)  
(see p.6, No. 40)



Please connect a Thunderbolt™ add-in card (AIC) to this connector via the GPIO cable.

*The USB3\_2 port on the rear I/O is shared with the USB\_1\_2 header on the motherboard. Please refer to p.18 for jumper setup information.*

---

USB 2.0 Header  
(19-pin USB\_1\_2)  
(see p.6, No. 20)

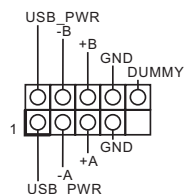

There is one USB 2.0 header on this motherboard. This USB 2.0 header can support two USB 2.0 ports.

## 2.7 Unit Identification purpose LED/Switch

With the UID button, You are able to locate the server you're working on from behind a rack of servers.

Unit Identification  
purpose LED/Switch  
(UID1)



When the UID button on the front or rear panel is pressed, the front/rear UID blue LED indicator will be turned on. Press the UID button again to turn off the indicator.

## 2.8 Driver Installation Guide

To install the drivers to your system, please insert the support CD to your optical drive first. Then, the drivers compatible to your system can be auto-detected and listed on the support CD driver page. Please follow the order from top to bottom to install those required drivers. Therefore, the drivers you install can work properly.

## 2.9 Dual LAN and Teaming Operation Guide

Dual LAN with Teaming enabled on this motherboard allows two single connections to act as one single connection for twice the transmission bandwidth, making data transmission more effective and improving the quality of transmission of distant images. Fault tolerance on the dual LAN network prevents network downtime by transferring the workload from a failed port to a working port.



*The speed of transmission is subject to the actual network environment or status even with Teaming enabled.*

Before setting up Teaming, please make sure whether your Switch (or Router) supports Teaming (IEEE 802.3ad Link Aggregation). You can specify a preferred adapter in Intel PROSet. Under normal conditions, the Primary adapter handles all non-TCP/IP traffic. The Secondary adapter will receive fallback traffic if the primary fails. If the Preferred Primary adapter fails, but is later restored to an active status, control is automatically switched back to the Preferred Primary adapter.

### **Step 1**

From **Device Manager**, open the properties of a team.

### **Step 2**

Click the **Settings** tab.

### **Step 3**

Click the **Modify Team** button.

### **Step 4**

Select the adapter you want to be the primary adapter and click the **Set Primary** button.

If you do not specify a preferred primary adapter, the software will choose an adapter of the highest capability (model and speed) to act as the default primary. If a failover occurs, another adapter becomes the primary. The adapter will, however, rejoin the team as a non-primary.



# Chapter 3 UEFI Setup Utility

## 3.1 Introduction

This section explains how to use the UEFI SETUP UTILITY to configure your system. The UEFI chip on the motherboard stores the UEFI SETUP UTILITY. You may run the UEFI SETUP UTILITY when you start up the computer. Please press <F2> or <Del> during the Power-On-Self-Test (POST) to enter the UEFI SETUP UTILITY; otherwise, POST will continue with its test routines.

If you wish to enter the UEFI SETUP UTILITY after POST, restart the system by pressing <Ctrl> + <Alt> + <Delete>, or by pressing the reset button on the system chassis. You may also restart by turning the system off and then back on.



*Because the UEFI software is constantly being updated, the following UEFI setup screens and descriptions are for reference purpose only, and they may not exactly match what you see on your screen.*

### 3.1.1 UEFI Menu Bar

The top of the screen has a menu bar with the following selections:

Item	Description
Main	To set up the system time/date information
Advanced	To set up the advanced UEFI features
Security	To set up the security features
Boot	To set up the default system device to locate and load the Operating System
Event Logs	For event log configuration
Server Mgmt	To manage the server
Exit	To exit the current screen or the UEFI SETUP UTILITY

Use <←→> key or <→> key to choose among the selections on the menu bar, and then press <Enter> to get into the sub screen.

### 3.1.2 Navigation Keys

Please check the following table for the function description of each navigation key.

Navigation Key(s)	Function Description
← / →	Moves cursor left or right to select Screens
↑ / ↓	Moves cursor up or down to select items
+ / -	To change option for the selected items
<Tab>	Switch to next function
<Enter>	To bring up the selected screen
<PGUP>	Go to the previous page
<PGDN>	Go to the next page
<HOME>	Go to the top of the screen
<END>	Go to the bottom of the screen
<F1>	To display the General Help Screen
<F7>	Discard changes and exit the UEFI SETUP UTILITY
<F9>	Load optimal default values for all the settings
<F10>	Save changes and exit the UEFI SETUP UTILITY
<F12>	Print screen
<ESC>	Jump to the Exit Screen or exit the current screen

## 3.2 Main Screen

Once you enter the UEFI SETUP UTILITY, the Main screen will appear and display the system overview. The Main screen provides system overview information and allows you to set the system time and date.

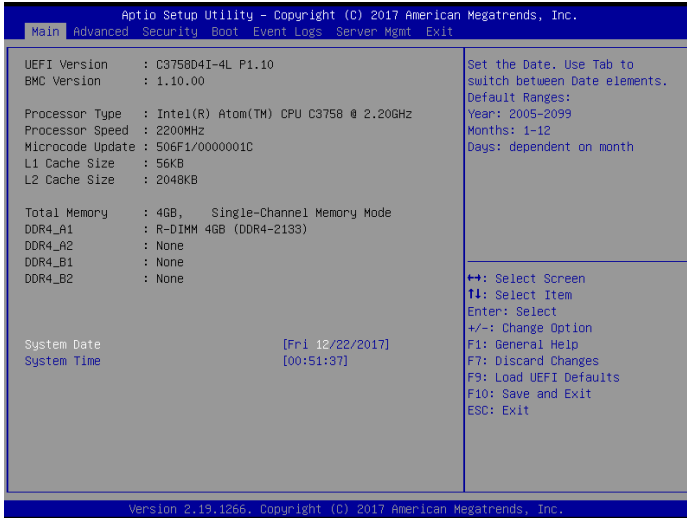

### 3.3 Advanced Screen

In this section, you may set the configurations for the following items: CPU Configuration, DRAM Configuration, Chipset Configuration, Storage Configuration, ACPI Configuration, USB Configuration, Super IO Configuration, Serial Port Console Redirection, H/W Monitor, System Event Log, Intel SPS Configuration and Instant Flash.

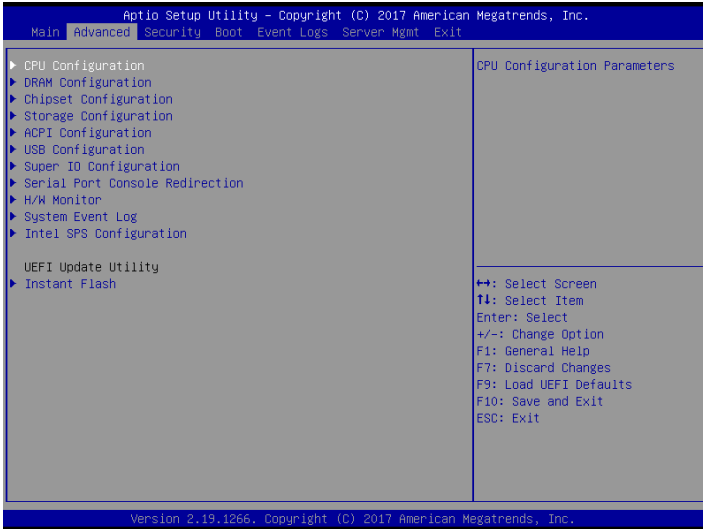

Setting wrong values in this section may cause the system to malfunction.

### 3.3.1 CPU Configuration

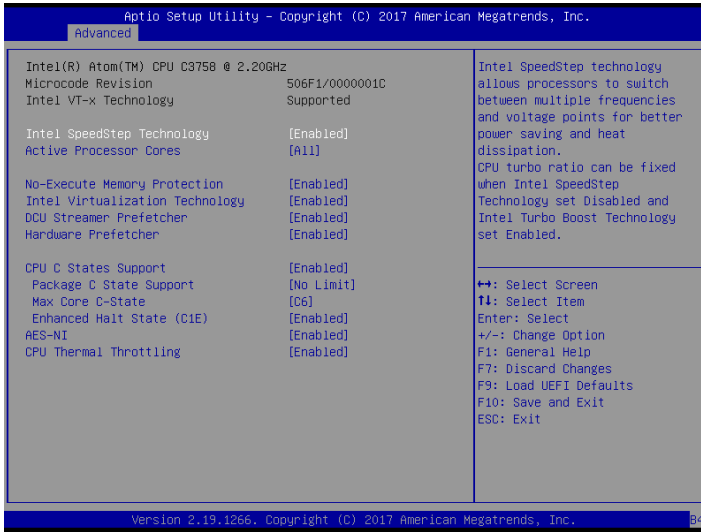

#### Intel SpeedStep Technology

Intel SpeedStep technology is Intel's new power saving technology. Processors can switch between multiple frequencies and voltage points to enable power saving. The default value is [Enabled]. Configuration options: [Enabled] and [Disabled]. This item will be hidden if the current CPU does not support Intel SpeedStep technology.



Please note that enabling this function may reduce CPU voltage and lead to system stability or compatibility issues with some power supplies. Please set this item to [Disabled] if above issues occur.

#### Active Processor Cores

Select the number of cores to enable in each processor package.

#### No-Execute Memory Protection

Processors with No-Execution Memory Protection Technology may prevent certain classes of malicious buffer overflow attacks.

#### Intel Virtualization Technology

Intel Virtualization Technology allows a platform to run multiple operating systems and applications in independent partitions, so that one computer system can function as multiple virtual systems.

## DCU Streamer Prefetcher

DCU streamer prefetcher is an L1 data cache prefetcher (MSR 1A4h [2]).

## Hardware Prefetcher

Automatically prefetch data and code for the processor. Enable for better performance.

## CPU C States Support

Enable CPU C States Support for power saving. It is recommended to keep C3, C6 and C7 all enabled for better power saving.

## Package C State Support

Enable CPU, PCIe, Memory, Graphics C State Support for power saving.

## Max Core C-State

Options are C1 and C6.

## Enhanced Halt State(C1E)

Enable Enhanced Halt State (C1E) for lower power consumption.

## AES-NI

Use this item to enable or disable AES-NI support.

## CPU Thermal Throttling

Enable CPU internal thermal control mechanisms to keep the CPU from overheating.

### 3.3.2 DRAM Configuration

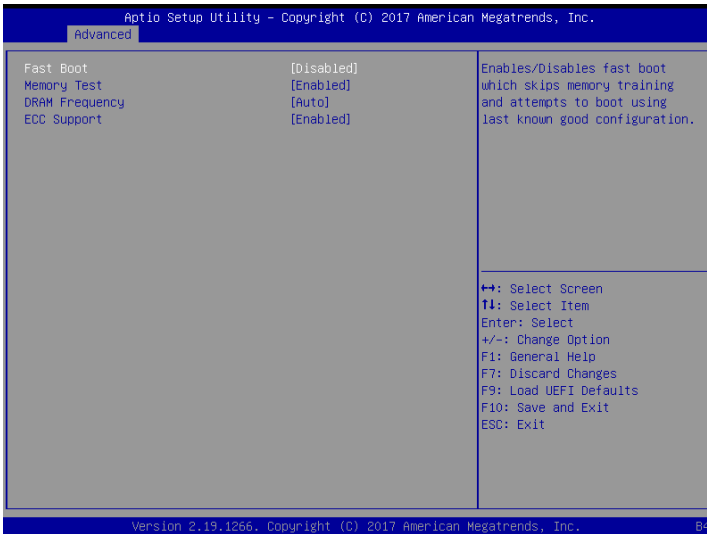

#### Fast Boot

Enables/Disables fast boot which skips memory training and attempts to boot using last known good configuration.

#### Memory Test

Enable/Disables MRC test that writes and reads certain regions of memory and stresses then through the use of the Converged Pattern Generation and Checking (CPGC) engine in order to verify if the memory operation is healthy.

#### DRAM Frequency

If [Auto] is selected, the motherboard will detect the memory module(s) inserted and assign the appropriate frequency automatically.

#### ECC Support

Use this item to enable or disable DDR ECC Support.

### 3.3.3 Chipset Configuration

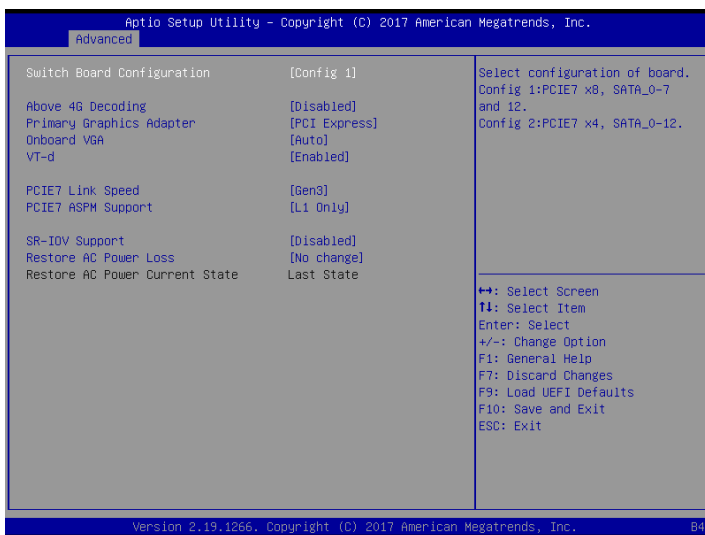

#### Switch Board Configuration

Select configuration of board.

C3758D4I-4L	C3558D4I-4L
Config 1: PCIE7 x8, SATA_0-7	Config 1: PCIE7 x4, SATA_0-3 and 12
Config 2: PCIE7 x4, SATA_0-12	Config 2: PCIE7 x4, SATA_4-7
	Config 3: PCIE7 x4, SATA_8-12
	Config 4: PCIE7 x8, SATA_12
	Config 5: SATA_0-7 and SATA_12
	Config 6: SATA_4-12
	Config 7: SATA_0-3 and SATA_8-12

#### Above 4G Decoding

Enable or disable 64bit capable Devices to be decoded in Above 4G Address Space (only if the system supports 64 bit PCI decoding).

#### Primary Graphics Adapter

If PCI Express graphics card is installed on the motherboard, you may use this option to select PCI Express , Onboard VGA or Onboard Hdmi as the primary graphics adapter.

*\*If no PCI Express graphics card is installed, [Onboard VGA] is the default graphics adapter. There is no screen on monitor even if a HDMI display is connected. Select [Onboard Hdmi] instead to use HDMI as output source.*



## Onboard VGA

Use this to enable or disable the Onboard VGA function. The default value is [Auto].

*\*This item is not available when the Primary Graphic Adapter is set to [Onboard VGA] or [Onboard Hdmi].*

## VT-d

Intel Virtualization Technology for Directed I/O helps your virtual machine monitor better utilize hardware by improving application compatibility and reliability, and providing additional levels of manageability, security, isolation, and I/O performance.

## PCIe7 ASPM Support

This option enables or disables the ASPM support for all CPU downstream devices.

## PCIe 7 Link Speed

This allows you to select PCIe 7 Link Speed. The default value is [Auto].

## SR-IOV Support

If system has SR-IOV capable PCIe Devices, this option Enables or Disables Single Root IO Virtualization Support.

## Restore on AC Power Loss

This allows you to set the power state after an unexpected AC/power loss. If [Power Off] is selected, the AC/power remains off when the power recovers. If [Power On] is selected, the AC/power resumes and the system starts to boot up when the power recovers. If [Last State] is selected, it will recover to the state before AC/power loss.

### 3.3.4 Storage Configuration

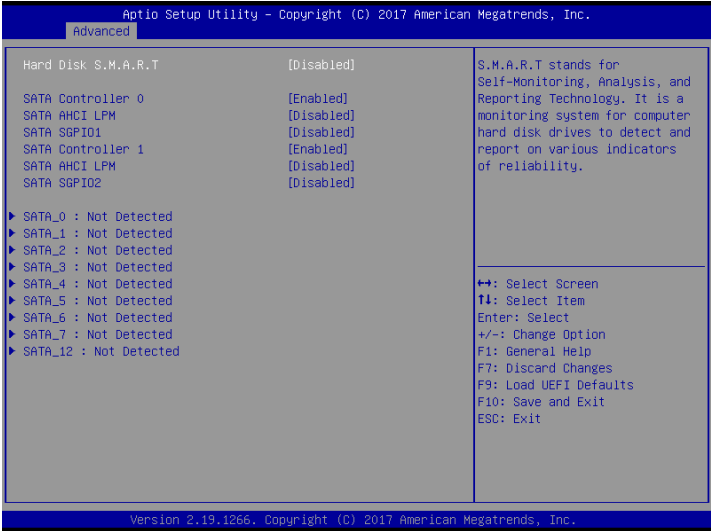

#### Hard Disk S.M.A.R.T.

Use this item to enable or disable the S.M.A.R.T. (Self-Monitoring, Analysis, and Reporting Technology) feature. Configuration options: [Disabled] and [Enabled].

#### SATA Controller 0

Use this item to enable or disable the SATA controller 0 for SATA\_0 to SATA\_3 and SATA\_8 to SATA\_11.

#### SATA AHCI LPM

Use this item to enable or disable Link Power Management. It is only supported by AHCI mode for SATA\_0 to SATA\_3 and SATA\_8 to SATA\_11.

#### SATA SGPIO1

Enables SATA SGPIO1 function. If Enabled SATA SGPIO please insert jumper to J5.

#### SATA Controller 1

Use this item to enable or disable the SATA controller 1 for SATA\_4 to SATA\_7 and SATA\_12.

#### SATA AHCI LPM

Use this item to enable or disable Link Power Management. It is only supported by AHCI

mode for SATA\_4 to SATA\_7 and SATA\_12.

## SATA SGPIO2

Enables SATA SGPIO2 function. If Enabled SATA SGPIO please insert jumper to J6.

### 3.3.5 ACPI Configuration

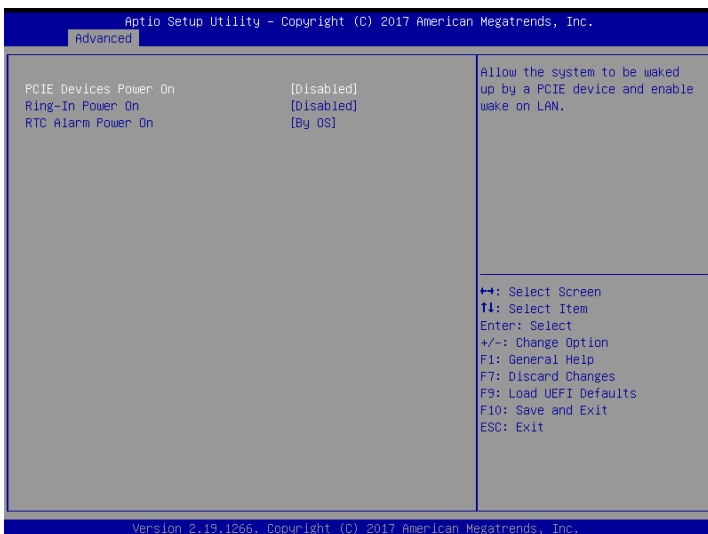

#### PCIE Devices Power On

Use this item to enable or disable PCIE devices to turn on the system from the power-soft-off mode.

#### Ring-In Power On

Use this item to enable or disable Ring-In signals to turn on the system from the power-soft-off mode.

#### RTC Alarm Power On

Use this item to enable or disable RTC (Real Time Clock) to power on the system.

### 3.3.6 USB Configuration



#### Legacy USB Support

Enable or disable Legacy OS Support for USB 2.0 devices. If you encounter USB compatibility issues, it is recommended to disable legacy USB support. Select UEFI Setup Only to support USB devices under the UEFI setup and Window/Linux operating sustems only.

## 3.3.7 Super IO Configuration

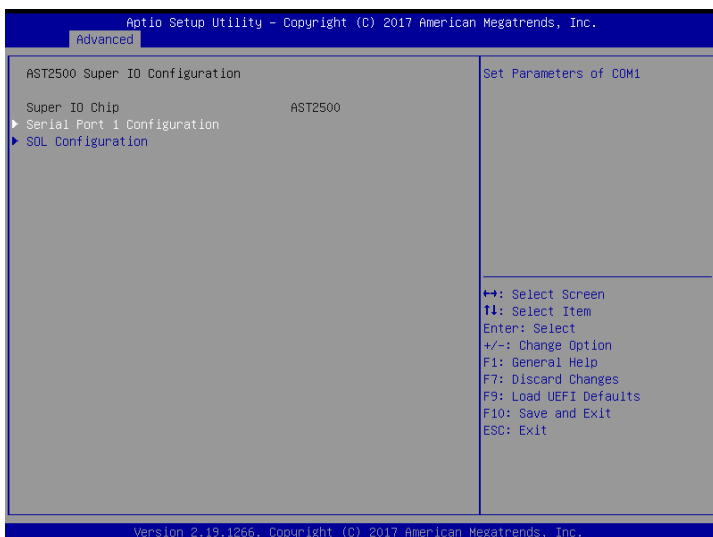

### Serial Port 1 Configuration

Use this item to set parameters of Serial Port 1 (COM1).

### Serial Port

Use this item to enable or disable the serial port.

### Serial Port Address

Use this item to select an optimal setting for Super IO device.

### SOL Configuration

Use this item to set SOL configuration.

### SOL Port

Use this item to enable or disable the SOL port.

### SOL Port Address

Use this item to select an optimal setting for Super IO device.

### 3.3.8 Serial Port Console Redirection

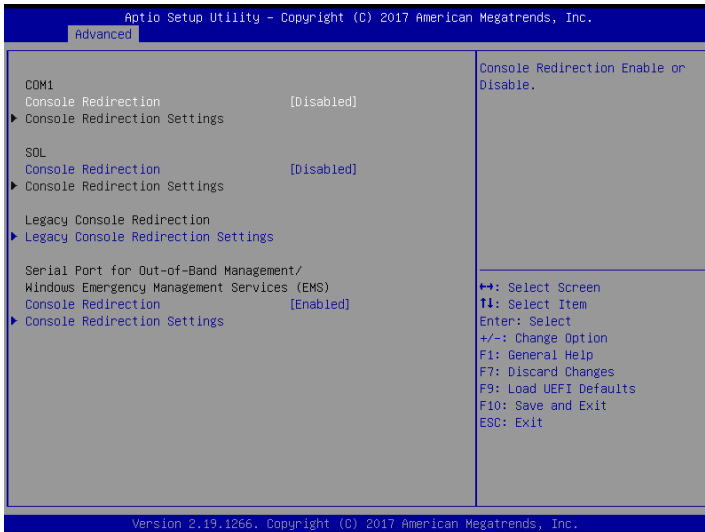

#### COM1 / SOL

#### Console Redirection

Use this option to enable or disable Console Redirection. If this item is set to Enabled, you can select a COM Port to be used for Console Redirection.

#### Console Redirection Settings

Use this option to configure Console Redirection Settings, and specify how your computer and the host computer to which you are connected exchange information. Both computers should have the same or compatible settings.

#### Terminal Type

Use this item to select the preferred terminal emulation type for out-of-band management. It is recommended to select [VT-UTF8].

Option	Description
VT100	ASCII character set
VT100+	Extended VT100 that supports color and function keys
VT-UTF8	UTF8 encoding is used to map Unicode chars onto 1 or more bytes
ANSI	Extended ASCII character set

### **Bits Per Second**

Use this item to select the serial port transmission speed. The speed used in the host computer and the client computer must be the same. Long or noisy lines may require lower transmission speed. The options include [9600], [19200], [38400], [57600] and [115200].

### **Data Bits**

Use this item to set the data transmission size. The options include [7] and [8] (Bits).

### **Parity**

Use this item to select the parity bit. The options include [None], [Even], [Odd], [Mark] and [Space].

### **Stop Bits**

The item indicates the end of a serial data packet. The standard setting is [1] Stop Bit. Select [2] Stop Bits for slower devices.

### **Flow Control**

Use this item to set the flow control to prevent data loss from buffer overflow. When sending data, if the receiving buffers are full, a "stop" signal can be sent to stop the data flow. Once the buffers are empty, a "start" signal can be sent to restart the flow. Hardware flow uses two wires to send start/stop signals. The options include [None] and [Hardware RTS/CTS].

### **VT-UTF8 Combo Key Support**

Use this item to enable or disable the VT-UTF8 Combo Key Support for ANSI/VT100 terminals.

### **Recorder Mode**

Use this item to enable or disable Recorder Mode to capture terminal data and send it as text messages.

### **Resolution 100x31**

Use this item to enable or disable extended terminal resolution support.

### **Putty Keypad**

Use this item to select Function Key and Keypad on Putty.

## **Legacy Console Redirection**

### **Legacy Console Redirection Settings**

Use this option to configure Legacy Console Redirection Settings, and specify how your computer and the host computer to which you are connected exchange information.

### **Redirection COM Port**

Use this item to select a COM port to display redirection of Legacy OS and Legacy OPROM Messages.

### **Resolution**

Use this item to select the number of rows and columns used in legacy OS redirection.



## Redirection After BIOS POST

If the [Bootloader] is selected, legacy console redirection is disabled before booting to legacy OS. If [Always Enabled] is selected, legacy console redirection is enabled for legacy OS. The default value is [Always Enabled].

## Serial Port for Out-of-Band Management/Windows Emergency Management Services (EMS)

### Console Redirection

Use this option to enable or disable Console Redirection. If this item is set to Enabled, you can select a COM Port to be used for Console Redirection.

### Console Redirection Settings

Use this option to configure Console Redirection Settings, and specify how your computer and the host computer to which you are connected exchange information.

### Out-of-Band Mgmt Port

Microsoft Windows Emergency Management Services (EMS) allows for remote management of a Windows Server OS through a serial port.

### Terminal Type

Use this item to select the preferred terminal emulation type for out-of-band management. It is recommended to select [VT-UTF8].

Option	Description
VT100	ASCII character set
VT100+	Extended VT100 that supports color and function keys
VT-UTF8	UTF8 encoding is used to map Unicode chars onto 1 or more bytes
ANSI	Extended ASCII character set

### Bits Per Second

Use this item to select the serial port transmission speed. The speed used in the host computer and the client computer must be the same. Long or noisy lines may require lower transmission speed. The options include [9600], [19200], [57600] and [115200].

### Flow Control

Use this item to set the flow control to prevent data loss from buffer overflow. When sending data, if the receiving buffers are full, a "stop" signal can be sent to stop the data flow. Once the buffers are empty, a "start" signal can be sent to restart the flow. Hardware flow uses two wires to send start/stop signals. The options include [None], [Hardware RTS/CTS], and [Software Xon/Xoff].

### Data Bits

### Parity

### Stop Bits

### 3.3.9 H/W Monitor

In this section, it allows you to monitor the status of the hardware on your system, including the parameters of the CPU temperature, motherboard temperature, CPU fan speed, chassis fan speed, and the critical voltage.

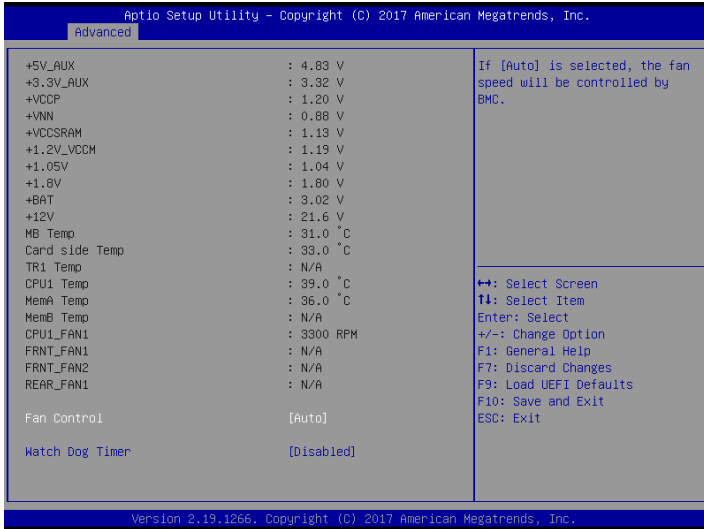

#### Fan Control

If [Auto] is selected, the fan speed will be controlled by BMC.

If [Manual] is selected, configure the items below.

#### CPU1\_FAN1

This allows you to set the CPU fan1's speed. The default value is [Smart Fan].

#### REAR\_FAN 1

This allows you to set the rear fan 1's speed. The default value is [Smart Fan].

#### FRNT\_FAN 1

This allows you to set the front fan 1's speed. The default value is [Smart Fan].

#### FRNT\_FAN 2

This allows you to set the front fan 2's speed. The default value is [Smart Fan].

#### Smart Fan Control

This allows you to set the Smart fan's level speed.

**Smart Fan Duty Control**

Smart Fan Duty x (x means 1 to 11 stage)

This allows you to set duty cycle for each stage.

**Smart Fan Temp Control**

Smart Fan Temp x (x means 1 to 11 stage)

This allows you to set temperature for each stage.

**Watch Dog Timer**

This allows you to enable or disable the Watch Dog Timer. The default value is [Disabled].

## 3.3.10 System Event Log

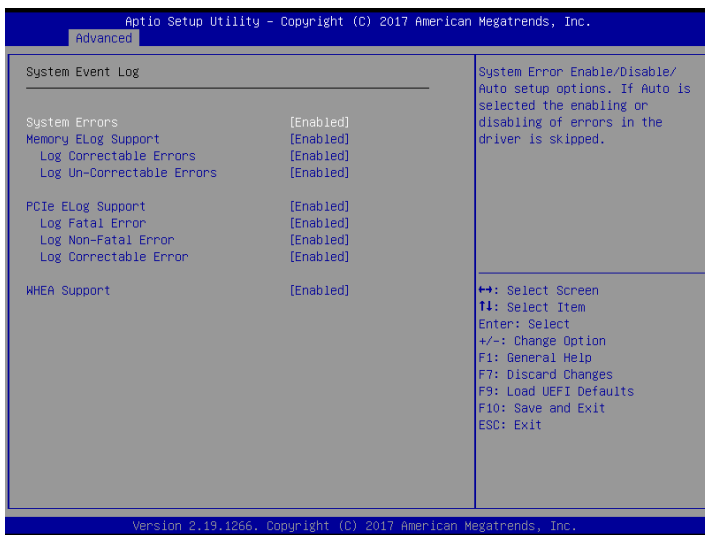

### System Errors

System Error Enable/Disable/Auto setup options. If Auto is selected, the enabling or disabling of errors in the driver is skipped.

### Memory ELog Support

Use this item to enable or disable Memory Error logging support.

### Log Correctable Errors

Use this item to enable or disable Correctable Memory Error logging support.

### Log Un-Correctable Errors

Use this item to enable or disable Un-Correctable Memory Error logging support.

### PCIe ELog Support

Use this item to enable or disable PCIe Error logging support.

### Log Fatal Error

Use this item to enable or disable sending system event Signal on Fatal error.

### Log Non-Fatal Error

Use this item to enable or disable sending system event Signal on Non Fatal error.

## Log Correctable Error

Use this item to enable or disable sending system event Signal on Correctable error

## Whea Suuport

Use this item to enable or disable Windows Hardware Error Architecture.

### 3.3.11 Intel SPS Configuration

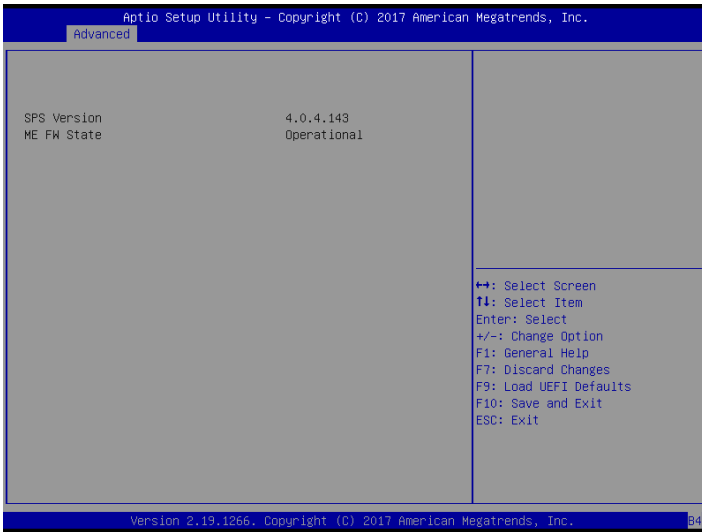

ME Subsystem screen displays the Intel ME Subsystem Configuration information, such as Operational Firmware Version and Firmware State.

### 3.3.12 Instant Flash

Instant Flash is a UEFI flash utility embedded in Flash ROM. This convenient UEFI update tool allows you to update system UEFI without entering operating systems first like MS-DOS or Windows<sup>®</sup>. Just save the new UEFI file to your USB flash drive, floppy disk or hard drive and launch this tool, then you can update your UEFI only in a few clicks without preparing an additional floppy diskette or other complicated flash utility. Please be noted that the USB flash drive or hard drive must use FAT32/16/12 file system. If you execute Instant Flash utility, the utility will show the UEFI files and their respective information. Select the proper UEFI file to update your UEFI, and reboot your system after the UEFI update process is completed.

## 3.4 Security Screen

In this section, you may set or change the supervisor/user password for the system. For the user password, you may also clear it.

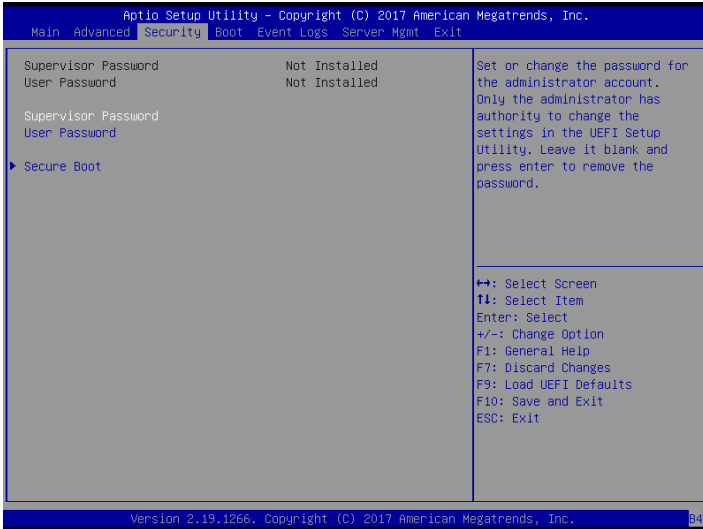

### Supervisor Password

Set or change the password for the administrator account. Only the administrator has authority to change the settings in the UEFI Setup Utility. Leave it blank and press enter to remove the password.

### User Password

Set or change the password for the user account. Users are unable to change the settings in the UEFI Setup Utility. Leave it blank and press enter to remove the password.



## 3.4.1 Secure Boot

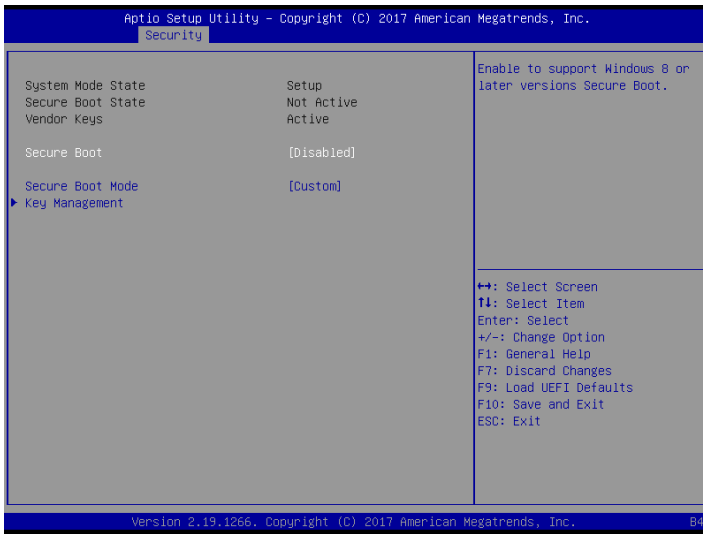

### Secure Boot

Enable to support Windows 8 or later version Secure Boot.

### Secure Boot Mode

Secure Boot mode selector: Standard/Custom. In Custom mode, Secure Boot Variables can be configured without authentication.

## 3.4.2 Key Management

In this section, expert users can modify Secure Boot Policy variables without full authentication.

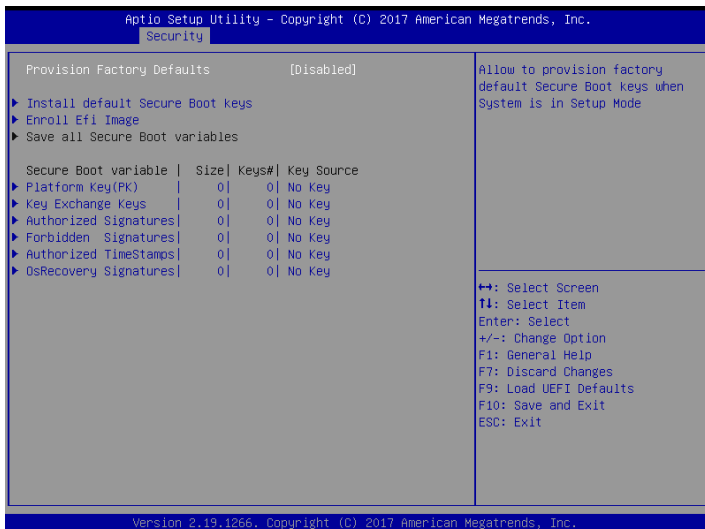

### Provision Factory Defaults

Allow to provision factory default Secure Boot keys when System is in Setup Mode.

### Install Default Secure Boot Keys

Please install default secure boot keys if it's the first time you use secure boot.

### Clear Secure Boot keys

Force System to Setup Mode - clear all Secure Boot Variables. Change takes effect after reboot.

### Enroll Efi Image

Allow the image to run in Secure Boot mode. Enroll SHA256 hash of the binary into Authorized Signature Database (db).

### Save all Secure Boot variables

Save NVRAM content of Secure Boot policy variables to the files (EFI\_SIGNATURE\_LIST data format) in root folder on a target file system device.

## Platform Key(PK)

Enroll Factory Defaults or load certificates from a file:

1. Public Key Certificate in:

- a) EFI\_SIGNATURE\_LIST
- b) EFI\_CERT\_X509 (DER encoded)
- c) EFI\_CERT\_RSA2048 (bin)
- d) EFI\_CERT\_SHA256, 384, 512

2. Authenticated UEFI Variable

3. EFI PE/COFF Image(SHA256)

Key Source: Default, External, Mixed, Test

## Key Exchange Keys

Enroll Factory Defaults or load certificates from a file:

1. Public Key Certificate in:

- a) EFI\_SIGNATURE\_LIST
- b) EFI\_CERT\_X509 (DER encoded)
- c) EFI\_CERT\_RSA2048 (bin)
- d) EFI\_CERT\_SHA256, 384, 512

2. Authenticated UEFI Variable

3. EFI PE/COFF Image(SHA256)

Key Source: Default, External, Mixed, Test

## Authorized Signatures

Enroll Factory Defaults or load certificates from a file:

1. Public Key Certificate in:

- a) EFI\_SIGNATURE\_LIST
- b) EFI\_CERT\_X509 (DER encoded)
- c) EFI\_CERT\_RSA2048 (bin)
- d) EFI\_CERT\_SHA256, 384, 512

2. Authenticated UEFI Variable
3. EFI PE/COFF Image(SHA256)

Key Source: Default, External, Mixed, Test

## Forbidden Signatures

Enroll Factory Defaults or load certificates from a file:

1. Public Key Certificate in:
  - a) EFI\_SIGNATURE\_LIST
  - b) EFI\_CERT\_X509 (DER encoded)
  - c) EFI\_CERT\_RSA2048 (bin)
  - d) EFI\_CERT\_SHA256, 384, 512
2. Authenticated UEFI Variable
3. EFI PE/COFF Image(SHA256)

Key Source: Default, External, Mixed, Test

## Authorized TimeStamps

Enroll Factory Defaults or load certificates from a file:

1. Public Key Certificate in:
  - a) EFI\_SIGNATURE\_LIST
  - b) EFI\_CERT\_X509 (DER encoded)
  - c) EFI\_CERT\_RSA2048 (bin)
  - d) EFI\_CERT\_SHA256, 384, 512
2. Authenticated UEFI Variable
3. EFI PE/COFF Image(SHA256)

Key Source: Default, External, Mixed, Test

## OsRecovery Signatures

Enroll Factory Defaults or load certificates from a file:

1. Public Key Certificate in:
  - a) EFI\_SIGNATURE\_LIST

b) EFI\_CERT\_X509 (DER encoded)

c) EFI\_CERT\_RSA2048 (bin)

d) EFI\_CERT\_SHA256, 384, 512

2. Authenticated UEFI Variable

3. EFI PE/COFF Image(SHA256)

Key Source: Default, External, Mixed, Test

## 3.5 Boot Screen

In this section, it will display the available devices on your system for you to configure the boot settings and the boot priority.

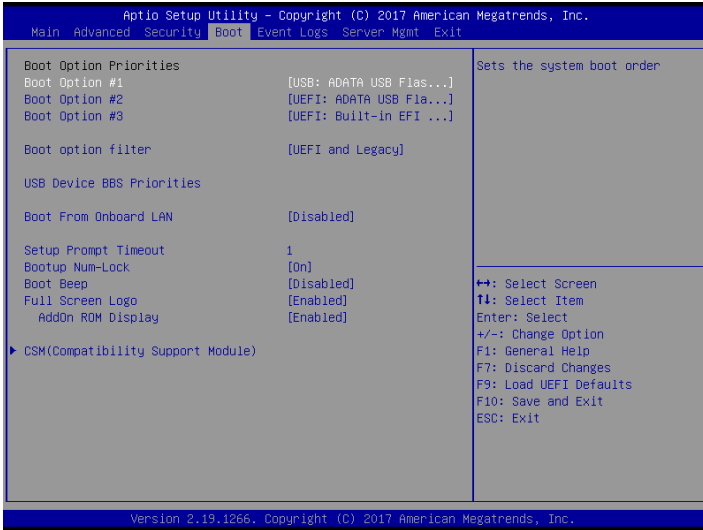

### Boot Option Priorities

#### Boot Option #1

Use this item to set the system boot order.

#### Boot Option #2

Use this item to set the system boot order.

#### Boot Option #3

Use this item to set the system boot order.

#### Boot Option Filter

This option controls Legacy/UEFI ROMs priority.

#### USB Device BBS Priorities

Use this item to set the system boot order from USB devices.

#### Boot From Onboard LAN

Use this item to enable or disable the Boot From Onboard LAN feature.

## Setup Prompt Timeout

This shows the number of seconds to wait for setup activation key. 65535(0XFFFF) means indefinite waiting.

## Bootup Num-Lock

If this item is set to [On], it will automatically activate the Numeric Lock function after boot-up.

## Boot Beep

Select whether the Boot Beep should be turned on or off when the system boots up. Please note that a buzzer is needed.

## Full Screen Logo

Use this item to enable or disable OEM Logo. The default value is [Enabled].

## AddOn ROM Display

Use this option to adjust AddOn ROM Display. If you enable the option "Full Screen Logo" but you want to see the AddOn ROM information when the system boots, please select [Enabled]. Configuration options: [Enabled] and [Disabled]. The default value is [Enabled].

## 3.5.1 CSM(Compatibility Support Module)

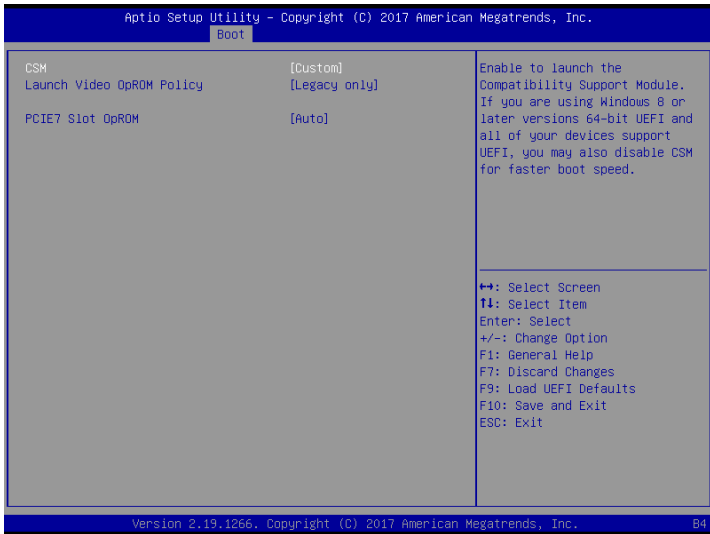

### CSM

Enable to launch the Compatibility Support Module. Please do not disable unless you're running a WHCK test. If you are using Windows 8.1 64-bit and all of your devices support UEFI, you may also disable CSM for faster boot speed.

Items below vary depending on the CSM option.

### Launch Video OpROM Policy

Select UEFI only to run those that support UEFI option ROM only. Select Legacy only to run those that support legacy option ROM only. Select Do not launch to not execute both legacy and UEFI option ROM.

### PCIe7 Slot OpROM

This option controls Legacy/UEFI ROMs priority.



## 3.6 Event Logs Screen

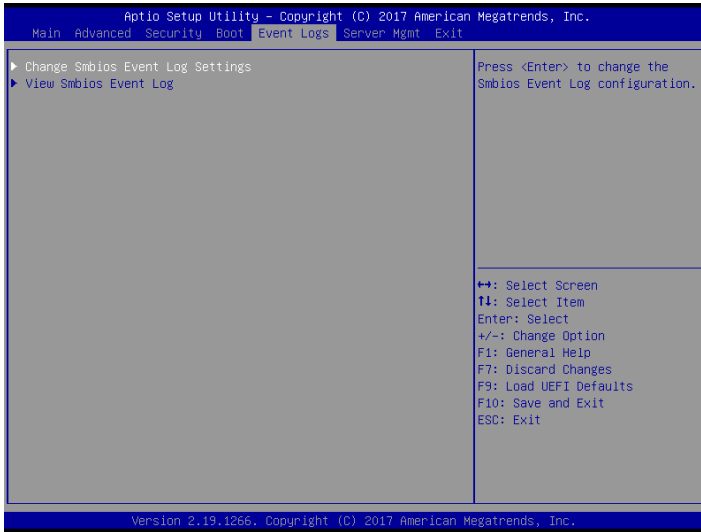

### Change Smbios Event Log Settings

This allows you to configure the Smbios Event Log Settings.

When entering the item, you will see the followings:

#### **Smbios Event Log**

Use this item to enable or disable all features of the SMBIOS Event Logging during system boot.

#### **Erase Event Log**

The options include [No], [Yes, Next reset] and [Yes, Every reset]. If Yes is selected, all logged events will be erased.

#### **When Log is Full**

Use this item to choose options for reactions to a full Smbios Event Log. The options include [Do Nothing] and [Erase Immediately].

#### **MECI (Multiple Event Count Increment)**

Use this item to enter the increment value for the multiple event counter. The valid range is from 1 to 255.

#### **METW (Multiple Event Time Window)**

Use this item to specify the number of minutes which must pass between duplicate log entries which utilize a multiple-event counter. The value ranges from 0 to 99 minutes.

## View Smbios Event Log

Press <Enter> to view the Smbios Event Log records.



*All values changed here do not take effect until computer is restarted.*

## 3.7 Server Mgmt Screen

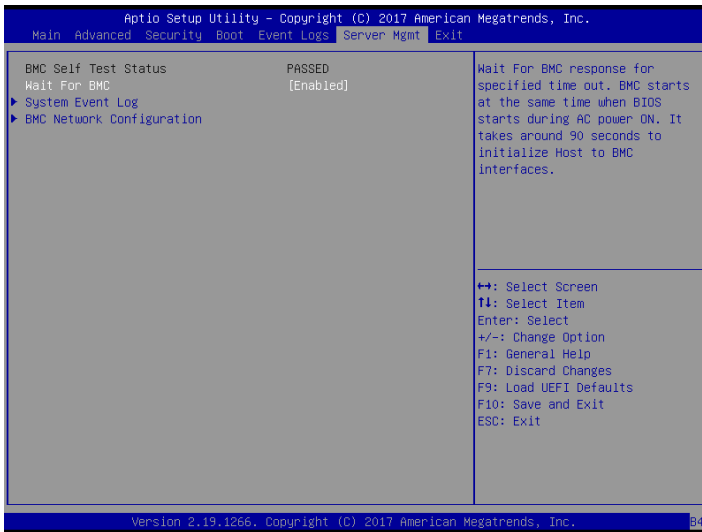

### Wait For BMC

Wait For BMC response for specified time out. In PILOTII, BMC starts at the same time when BIOS starts during AC power ON. It takes around 30 seconds to initialize Host to BMC interfaces.

## 3.7.1 System Event Log

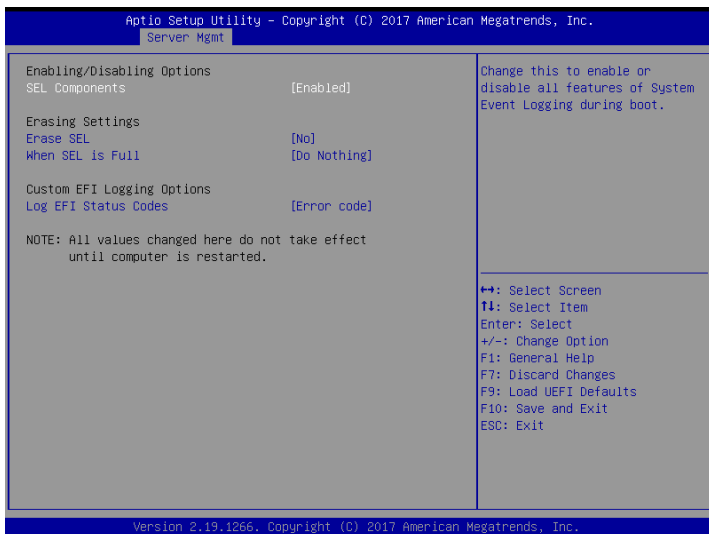

### SEL Components

Change this to enable or disable all features of System Event Logging during boot.

### Erase SEL

Use this to choose options for erasing SEL.

### When SEL is Full

Use this to choose options for reactions to a full SEL.

### Log EFI Status Codes

Use this item to disable the logging of EFI Status Codes or log only error code or only progress or both.

## 3.7.2 BMC Network Configuration



### Lan Channel (Failover)

### Manual Setting IPMI LAN

If [No] is selected, the IP address is assigned by DHCP. If you prefer using a static IP address, toggle to [Yes], and the changes take effect after the system reboots. The default value is [No].

### Configuration Address Source

Select to configure BMC network parameters statically or dynamically (by BIOS or BMC). Configuration options: [Static] and [DHCP].

**Static:** Manually enter the IP Address, Subnet Mask and Gateway Address in the BIOS for BMC LAN channel configuration.

**DHCP:** IP address, Subnet Mask and Gateway Address are automatically assigned by the network's DHCP server.



*When [DHCP] or [Static] is selected, do NOT modify the BMC network settings on the IPMI web page.*



The default login information for the IPMI web interface is:

Username: admin

Password: admin

ASROCKRACK

Username

Password

Remember Username

Sign in!

[Forgot my password?](#)

Language

English

For more instructions on how to set up remote control environment and use the IPMI management platform, please refer to the IPMI Configuration User Guide or go to the Support website at: <http://www.asrockrack.com/support/ipmi.asp>

## 3.8 Exit Screen

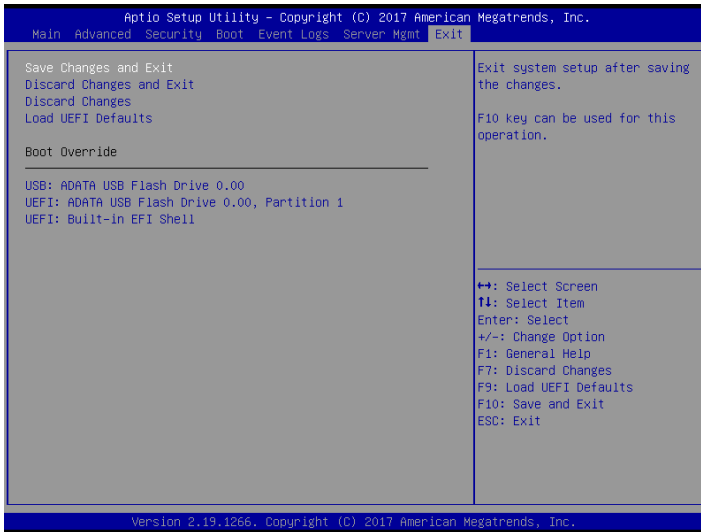

### Save Changes and Exit

When you select this option, the following message “Save configuration changes and exit setup?” will pop-out. Press <F10> key or select [Yes] to save the changes and exit the UEFI SETUP UTILITY.

### Discard Changes and Exit

When you select this option, the following message “Discard changes and exit setup?” will pop-out. Press <ESC> key or select [Yes] to exit the UEFI SETUP UTILITY without saving any changes.

### Discard Changes

When you select this option, the following message “Discard changes?” will pop-out. Press <F7> key or select [Yes] to discard all changes.

### Load UEFI Defaults

Load UEFI default values for all the setup questions. F9 key can be used for this operation.

### Boot Override

These items displays the available devices. Select an item to start booting from the selected device.

# Chapter 4 Software Support

## 4.1 Install Operating System

This motherboard supports Microsoft® Windows® Server 2008 R2 SP1 (64 bit) / 2012 (64 bit) / Linux compliant. Because motherboard settings and hardware options vary, use the setup procedures in this chapter for general reference only. Refer your OS documentation for more information.

## 4.2 Support CD Information

The Support CD that came with the motherboard contains necessary drivers and useful utilities that enhance the motherboard's features.

### 4.2.1 Running The Support CD

To begin using the support CD, insert the CD into your CD-ROM drive. The CD automatically displays the Main Menu if "AUTORUN" is enabled in your computer. If the Main Menu does not appear automatically, locate and double click on the file "ASRSetup.exe" from the root folder in the Support CD to display the menu.

### 4.2.2 Drivers Menu

The Drivers Menu shows the available device's drivers if the system detects installed devices. Please install the necessary drivers to activate the devices.

### 4.2.3 Utilities Menu

The Utilities Menu shows the application softwares that the motherboard supports. Click on a specific item then follow the installation wizard to install it.

### 4.2.4 Contact Information

If you need to contact ASRock Rack or want to know more about ASRock Rack, welcome to visit ASRock Rack's website at <http://www.ASRockRack.com>; or you may contact your dealer for further information.



# Chapter 5 Troubleshooting

## 5.1 Troubleshooting Procedures

Follow the procedures below to troubleshoot your system.



*Always unplug the power cord before adding, removing or changing any hardware components. Failure to do so may cause physical injuries to you and damages to motherboard components.*

1. Disconnect the power cable and check whether the PWR LED is off.
2. Unplug all cables, connectors and remove all add-on cards from the motherboard.  
Make sure that the jumpers are set to default settings.
3. Confirm that there are no short circuits between the motherboard and the chassis.
4. Install a CPU and fan on the motherboard, then connect the chassis speaker and power LED.

### **If there is no power...**

1. Confirm that there are no short circuits between the motherboard and the chassis.
2. Make sure that the jumpers are set to default settings.
3. Check the settings of the 115V/230V switch on the power supply.
4. Verify if the battery on the motherboard provides ~3VDC. Install a new battery if it does not.

### **If there is no video...**

1. Try replugging the monitor cables and power cord.
2. Check for memory errors.

### **If there are memory errors...**

1. Verify that the DIMM modules are properly seated in the slots.
2. Use recommended DDR3 1600/1333/1066 non ECC, unbuffered DIMMs.
3. If you have installed more than one DIMM modules, they should be identical with the same brand, speed, size and chip-type.
4. Try inserting different DIMM modules into different slots to identify faulty ones.
5. Check the settings of the 115V/230V switch on the power supply.

---

**Unable to save system setup configurations...**

1. Verify if the battery on the motherboard provides ~3VDC. Install a new battery if it does not.
2. Confirm whether your power supply provides adequate and stable power.

**Other problems...**

1. Try searching keywords related to your problem on ASRock Rack's FAQ page:  
<http://www.asrockrack.com/support>

## 5.2 Technical Support Procedures

If you have tried the troubleshooting procedures mentioned above and the problems are still unsolved, please contact ASRock Rack's technical support with the following information:

1. Your contact information
2. Model name, BIOS version and problem type
3. System configuration
4. Problem description

You may contact ASRock Rack's technical support at:

<http://www.asrockrack.com/support/tsd.asp>

## 5.3 Returning Merchandise for Service

For warranty service, the receipt or a copy of your invoice marked with the date of purchase is required. By calling your vendor or going to our RMA website (<http://event.asrockrack.com/tsd.asp>) you may obtain a Returned Merchandise Authorization (RMA) number.

The RMA number should be displayed on the outside of the shipping carton which is mailed prepaid or hand-carried when you return the motherboard to the manufacturer. Shipping and handling charges will be applied for all orders that must be mailed when service is complete.

This warranty does not cover damages incurred in shipping or from failure due to alteration, misuse, abuse or improper maintenance of products.

Contact your distributor first for any product related problems during the warranty period.