

CEZANNE

# Model 6 User Guide

用户指南

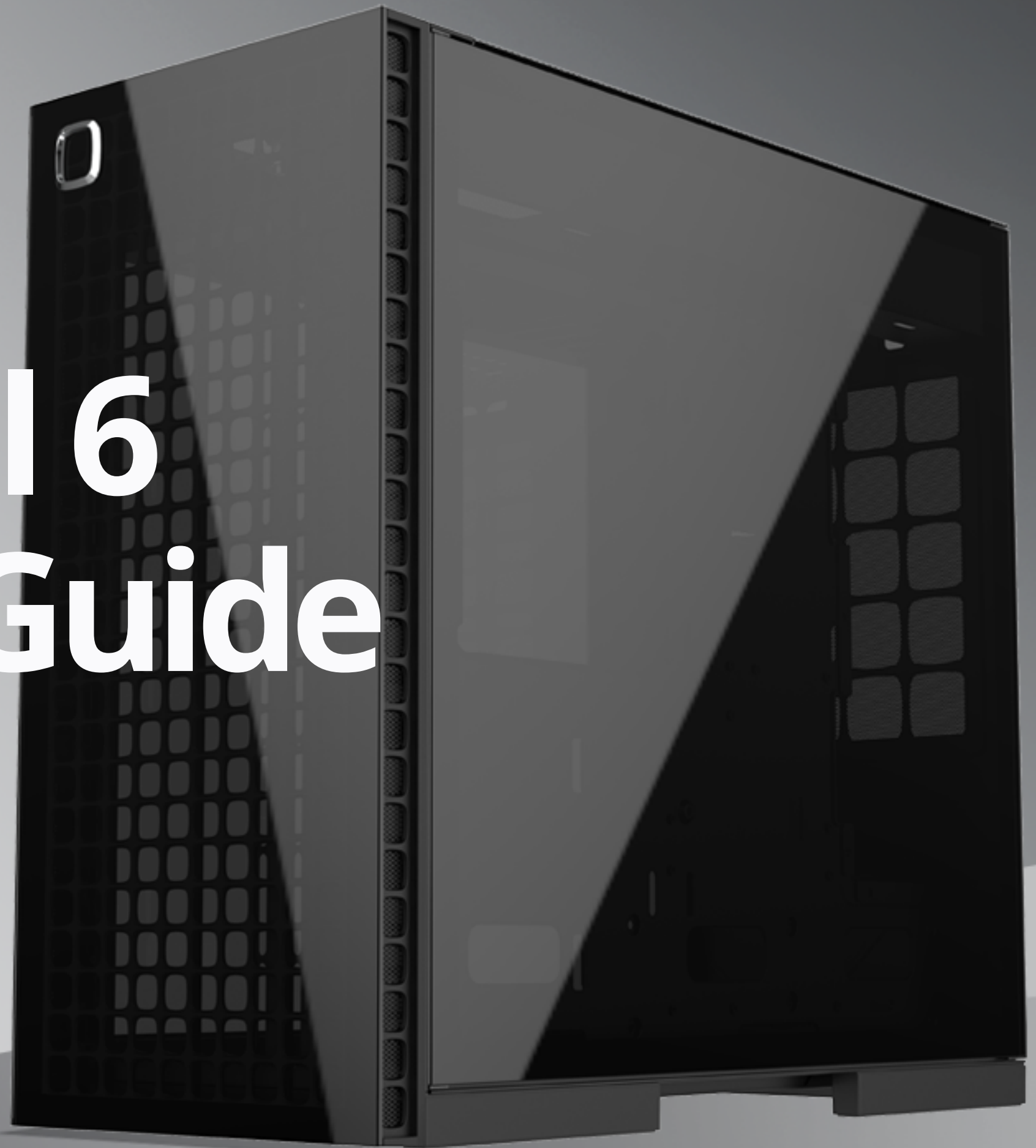

Model 6 系列

—

CEZANNE 塞尚

简约平凡里窥见真章



## 01

产品规格  
Specifications

## 02

产品特点  
Feature

## 03

零件包内容  
Parts Kit Includes

## 04

安装步骤  
How to assemble

拆除侧板及顶盖	Remove side panels and top panel	04
安装主板I/O挡片	Install the motherboard I/O baffle	05
安装主板	Install the motherboard	06
安装显卡	Install the graphics card	08
侧装显卡	Side-mounted graphics card	10
风扇及水冷安装选项	Fan and water cooling mounting options	12
安装底部风扇/水冷模组	Mount the bottom fan/water cooler	13
安装前部风扇/水冷	Mount the front fan/water cooler	16
安装顶部风扇/水冷	Mount the top fan/water cooler	18
锁装电源	Install the power cord	19
安装硬盘	Install hard drive	20
线材整理绑线位置	Cable management & routing	24
装回侧板与顶盖	Put back the end panel and top panel	25

## 26

前置I/O接线示意  
Front I/O wiring schematic, provided for premium cases

## 27

注意事项  
Precautions

## 28

保修范围  
Warranty

# SPECIFICATIONS

产品规格

<b>Model</b>	6
<b>Case Type</b>	Mid Tower
<b>Material</b>	Steel T0.8 , Tempered Glass T4.0
<b>Product Dimension (H x W x D)</b>	450 x 215 x 450 mm 17.7" x 8.5" x 17.7"
<b>Drive Bay</b>	Max: 4 x 3.5"/2.5" tray
<b>M/B Form Factor</b>	E-ATX (12" x 11") , ATX , Micro - ATX , Mini - ITX
<b>Power Supply</b>	PSII: ATX 12V (Length < 180 mm)
<b>I/O Ports</b>	USB 3.0 x 2 , HD Audio (CTIA-SPK/MIC)
<b>Expansion Slots (Maximum Space)</b>	PCI-E x 7: Length <350mm (No Cooling of bottom) / Width <165mm Lateral PCI-E x 2: Length <360mm (No Cooling of bottom) / Width <165mm / Height<54mm
<b>Thermal Solution</b>	Top : 120mm Fan x 1 120mm Radiator Front: 120mm Fan x 3 / 140mm Fan x 2 240/280mm Radiator ( Length < 361mm / Thickness is related to the height limit of the main board ) Bottom: 120/140mm Fan x 3 360/280mm Radiator ( Length < 440mm )
<b>CPU Heatsink</b>	Height < 162mm



# FEATURE

## 产品特点

<b>Excellent Heat Dissipation</b> 优秀散热	Vertical airflow/ full ventilation on three sides/ fast-ventilating meshy top panel / optimized 垂直三面风道 / 全面网高通风率顶盖 / 电源风道优化
<b>Superior Compatibility</b> 超强兼容性	12" x 11" motherboard / 7 x fan mounts / dual 360/420mm water cooling mounts / cpu cooler height: 162mm / rtx™ 30 series graphics card space: 360mm (l) x 165mm (w) x 61mm (h) / up to 4 hard drive brackets 主板 12"x 11" / 7组风扇位 / 360+240双水冷 / CPU散热器高162mm / 30系大显卡兼容空间 长360 x 宽165 x 厚61mm / 最多4组硬盘位
<b>Easy Access</b> 便捷操作	Removable & cleanable top panel / multifunctional hard drive bracket / removable & cleanable magnetic filter 可拆洗顶盖 / 多功能硬盘架 / 可拆洗磁吸滤网
<b>Personalized Installation</b> 安装可靠度	Indeformable vertically mounted graphics card /large cable routing space 竖装显卡无形变 / 超大背线空间/电源双向换装
<b>Durable Materials</b> 扎实用料	T0.8mm coated steel / t4.0mm tempered glass 全烤漆钢板 T0.8mm / 全钢化玻璃 T4.0mm
<b>Minimalist Style</b> 极简视效	Glass panels on two sides / meshy top panel 全面屏双侧透 / 全面网顶盖
<b>Perfect Handfeel</b> 极致触感	Aerospace-grade knitted fabric / soft fine linen... 航空针织面料 / 细软麻料 ...

# PARTS KIT INCLUDES

零件包内容

GEOMETRIC  
FUTURE  
Model 6 User Guide



## Motherboard / 2.5"SSD Screw 主板/2.5"硬盘螺丝

用途 主板 / 2.5"硬盘  
备注 M3  
数量 20



## Power Supply Screw 电源螺丝

用途 电源  
备注 #6-32  
数量 4



## Copper Stud 铜柱

用途 主板固定  
备注 外#6-32 / 内M3  
数量 3



## 3.5"HDD Screw 3.5"硬盘螺丝

用途 3.5"硬盘  
备注 #6-32  
数量 8



## Nylon Cable Tie 束线带

用途 整理线材  
备注 L 150  
数量 8



## Copper Stud Cover 铜柱套

用途 辅助铜柱  
备注 PH2  
数量 1

# HOW TO ASSEMBLE

## 安装步骤

GEO METRIC  
FUTURE  
Modle 6 User Guide

### 1 拆除侧板及顶盖

Remove side panels and top panel

- 拧松侧板螺丝 / 并依箭头指示方向拆除两侧板
- 依箭头指示方向拆除顶盖
- Loosen end panel screws
- Remove both side panels and top panel in the direction indicated by arrows



PH2

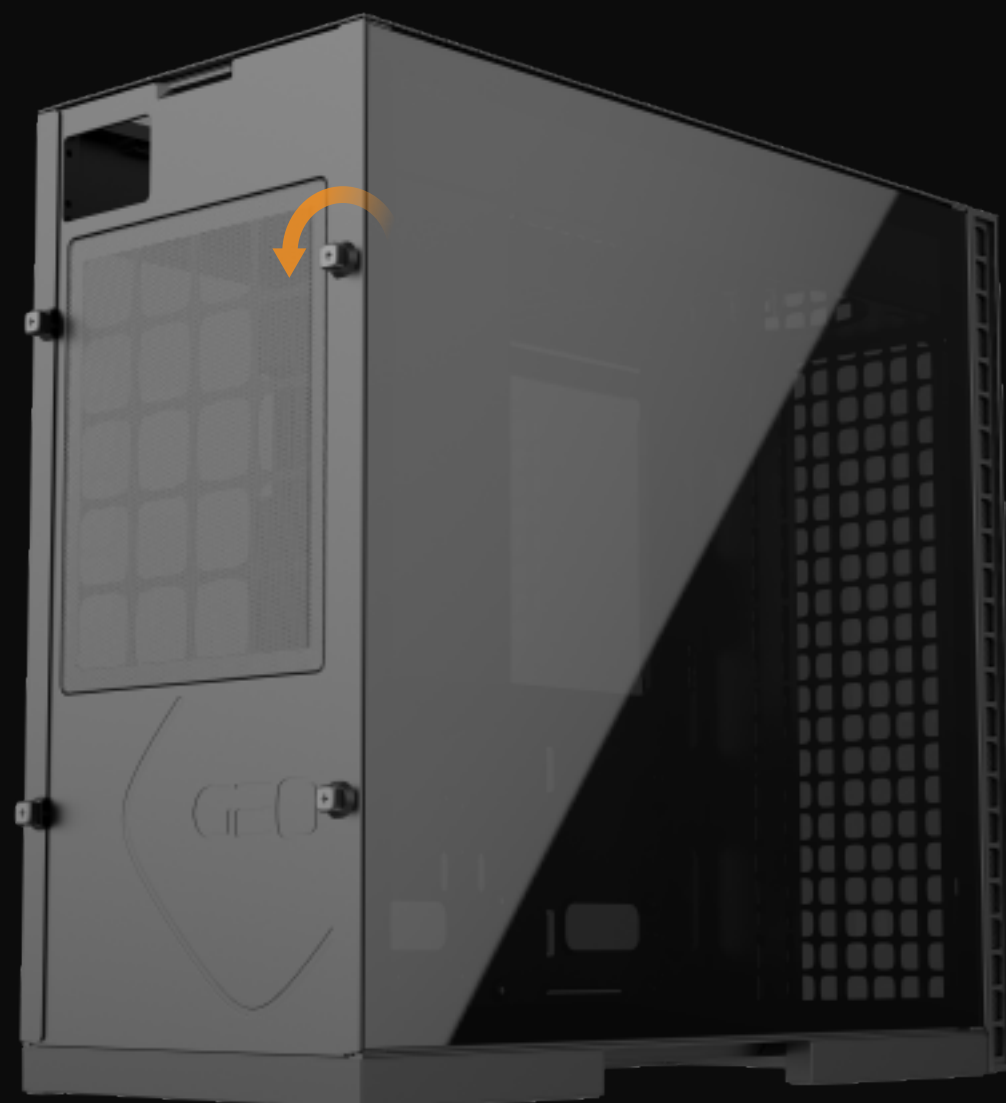

钢化玻璃拆装注意轻拿轻放!



## HOW TO ASSEMBLE

### 安装步骤

GEOMETRIC  
FUTURE  
Model 6 User Guide

2

### 安装主板I/O挡片

Install the motherboard I/O baffle





### 3 安装主板

Install the motherboard

Motherboard mounting hole locations table

主板孔位对照表

I	ITX
M	Micro—ATX
A	ATX
E	E-ATX

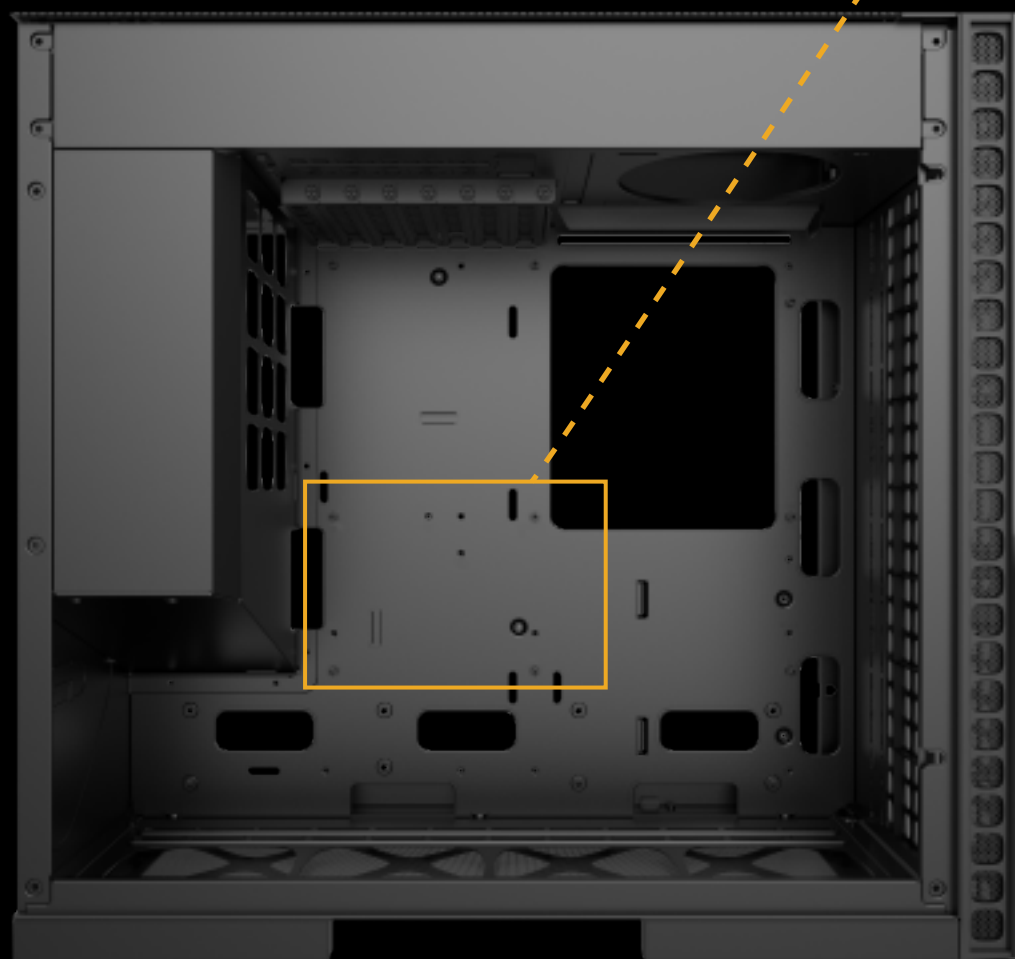

# HOW TO ASSEMBLE

## 安装步骤

GEO METRIC  
FUTURE  
Modle 6 User Guide

### 3 安装主板 Install the motherboard

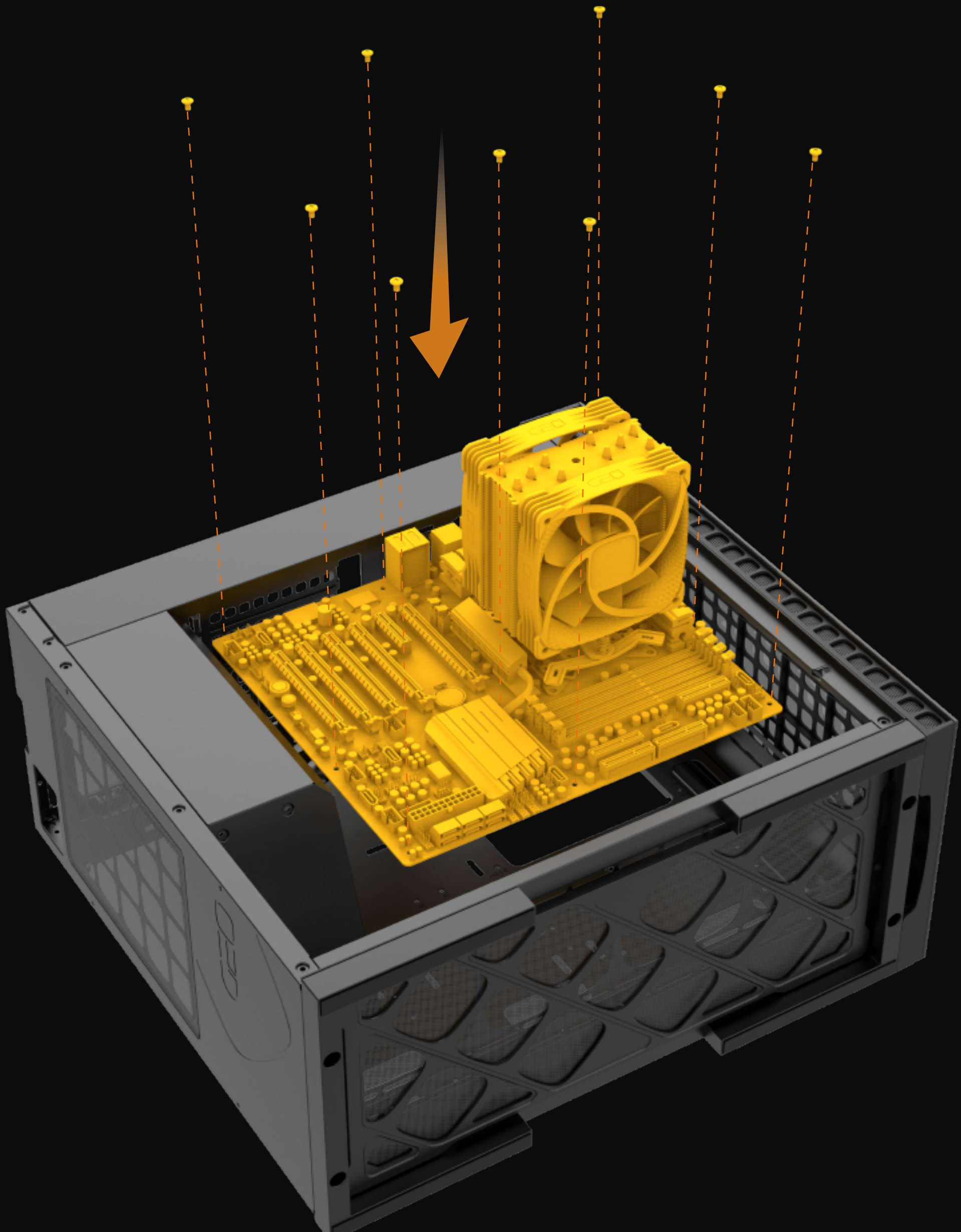

# HOW TO ASSEMBLE

## 安装步骤

GEO METRIC  
FUTURE  
Model 6 User Guide

### 4 安装显卡 Install the graphics card

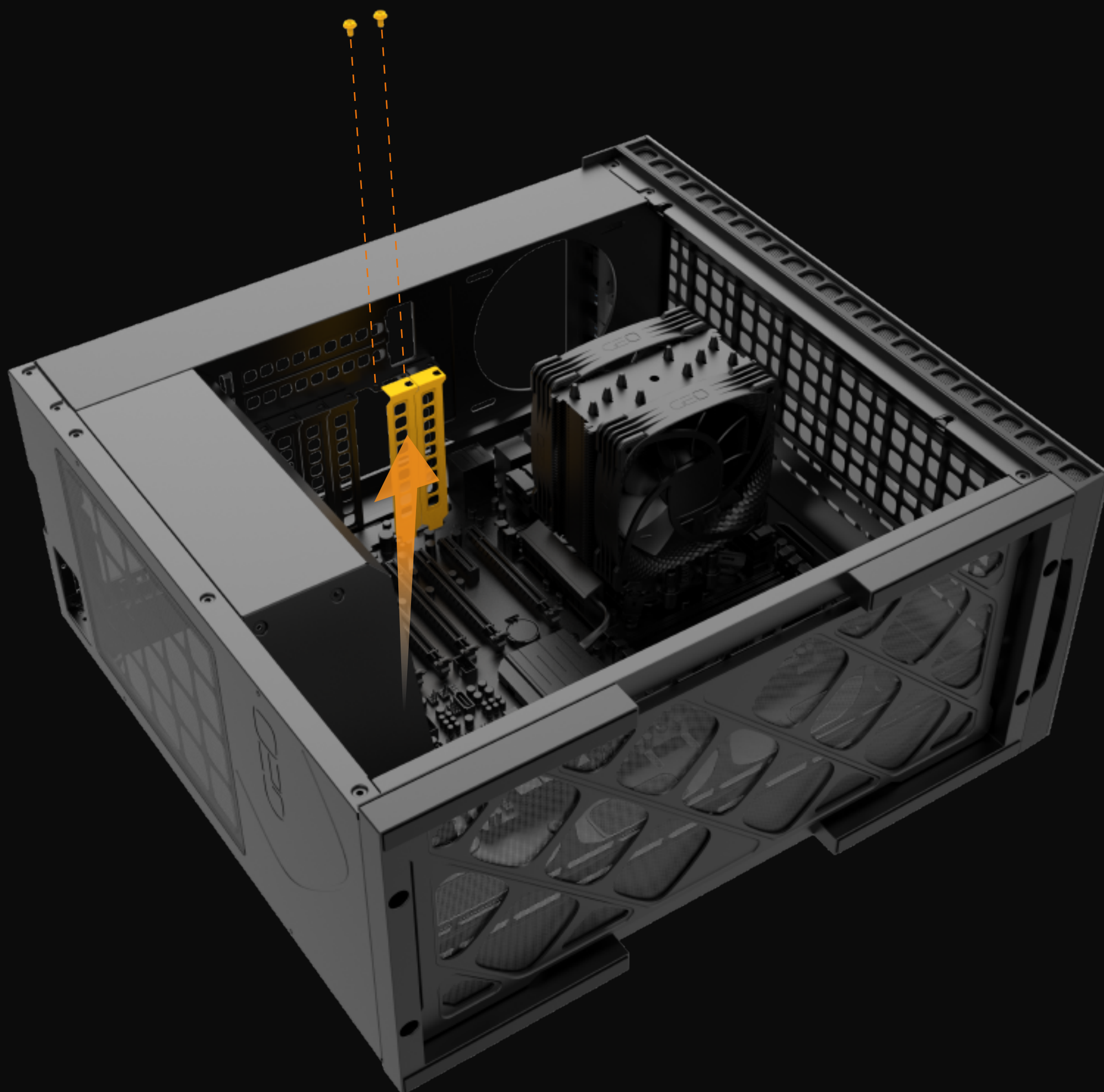

#### Step 1

#### 拆显卡封条

Remove the card seal sticker

### 4 安装显卡 Install the graphics card

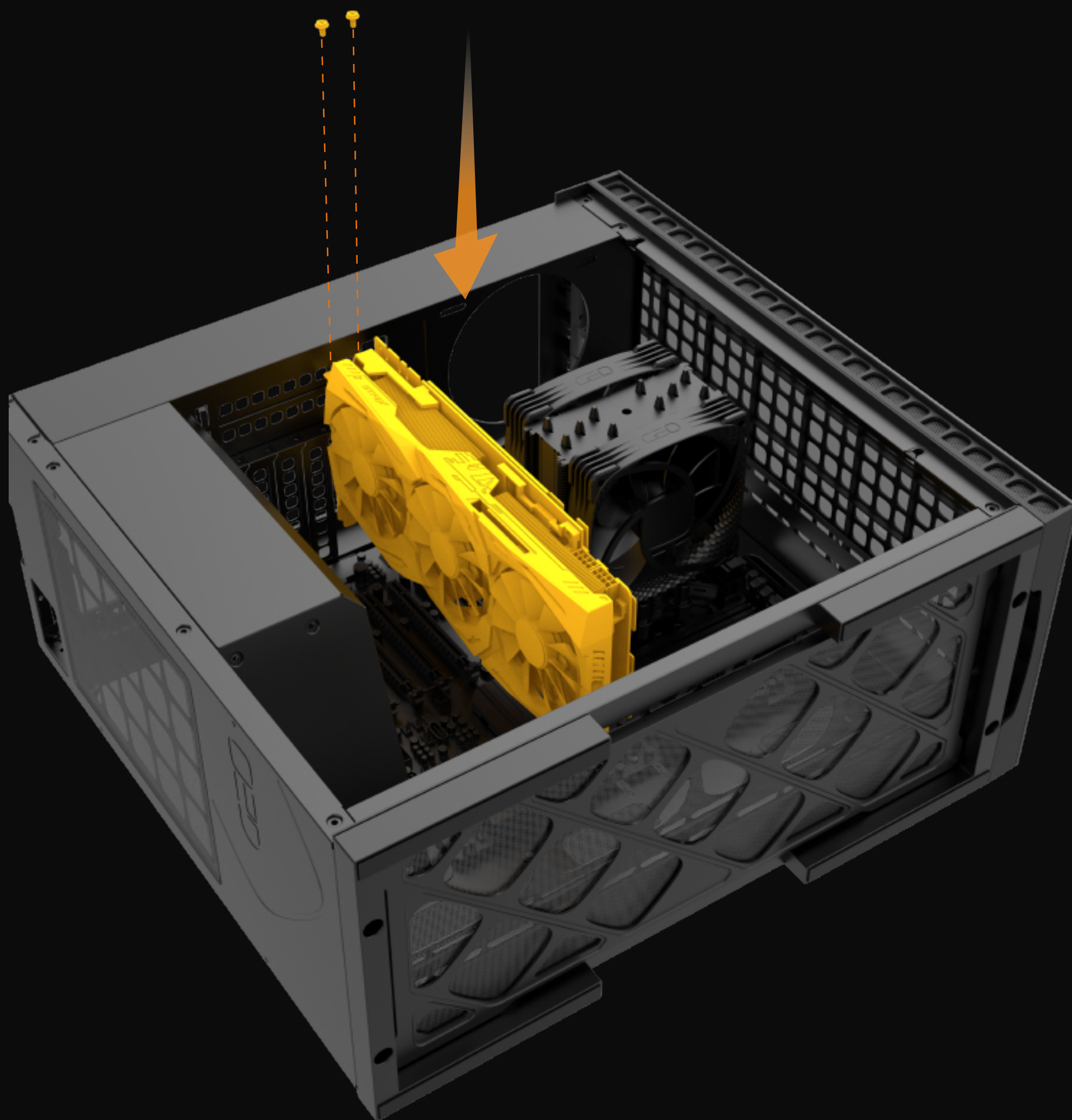

### Step 2

### 锁装显卡

Mount the graphics card

# HOW TO ASSEMBLE

## 安装步骤

GEOMETRIC  
FUTURE  
Model 6 User Guide

### 5 侧装显卡 (显卡转接板组需另购)

Side-mounted graphics card (graphics card adapter board needs to be purchased separately)



PH2



### Step 1

#### 拆显卡封条

Remove the card seal sticker  
(请使用工具拆卸挡片, 以防受伤)

# HOW TO ASSEMBLE

## 安装步骤

GEOMETRIC  
FUTURE  
Modle 6 User Guide

### 5 侧装显卡 (显卡转接板组需另购)

Side-mounted graphics card (graphics card adapter board needs to be purchased separately)



x2



PH2



### Step 2

#### 锁装显卡

Mount the graphics card

### 6 风扇及水冷安装选项 (尺寸限制参照产品规格表描述) Fan and water cooling mounting options (refer to product specifications for size limitation)



PH2

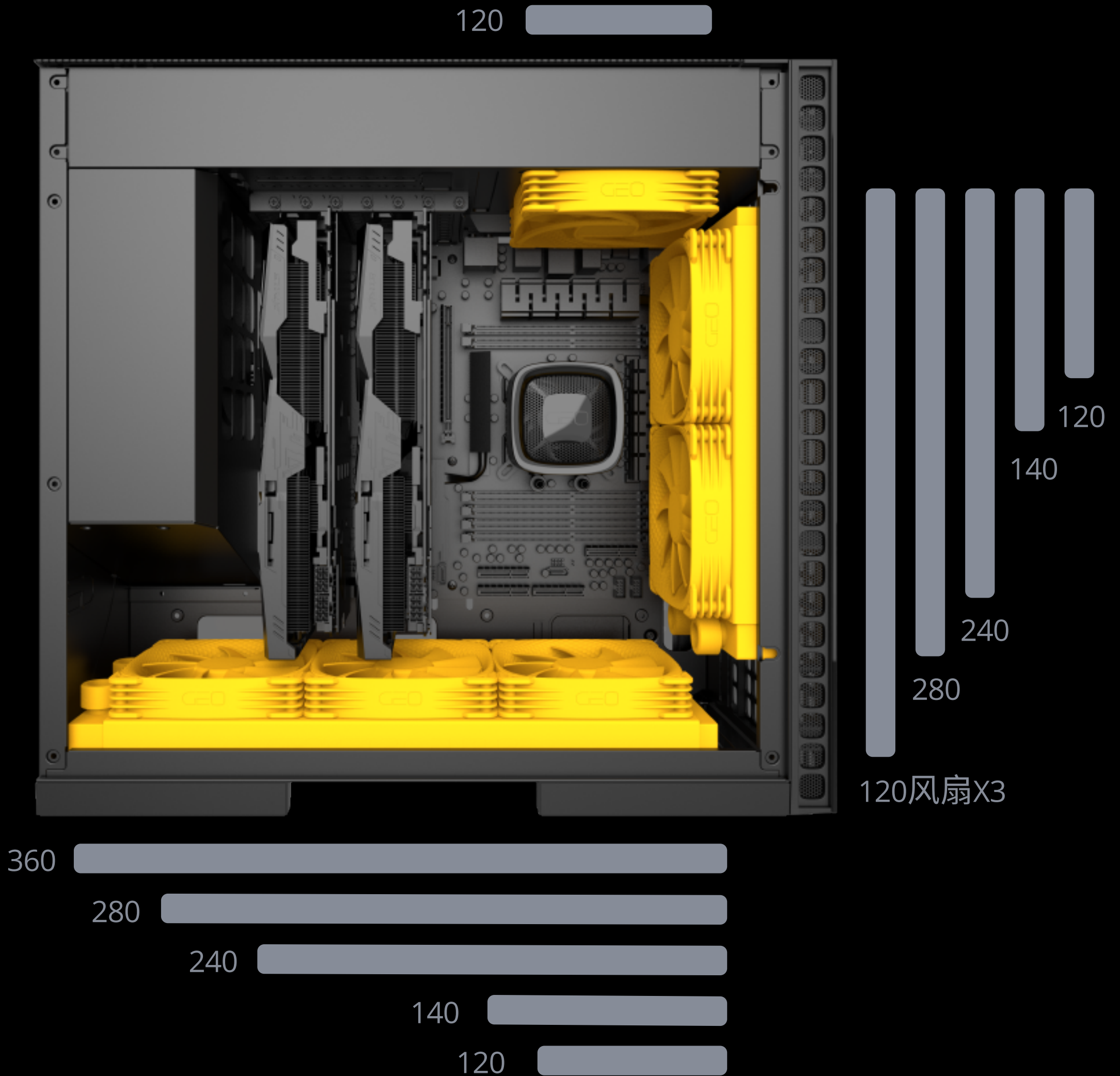

# HOW TO ASSEMBLE

## 安装步骤

GEOMETRIC  
FUTURE  
Modle 6 User Guide

### 7 安装底部风扇/水冷模组 Mount rear panel 120/240/360 water cooler



- Step 1** 拆取底部磁吸滤网  
Remove water cooler bracket and bottom magnetic suction filter screen

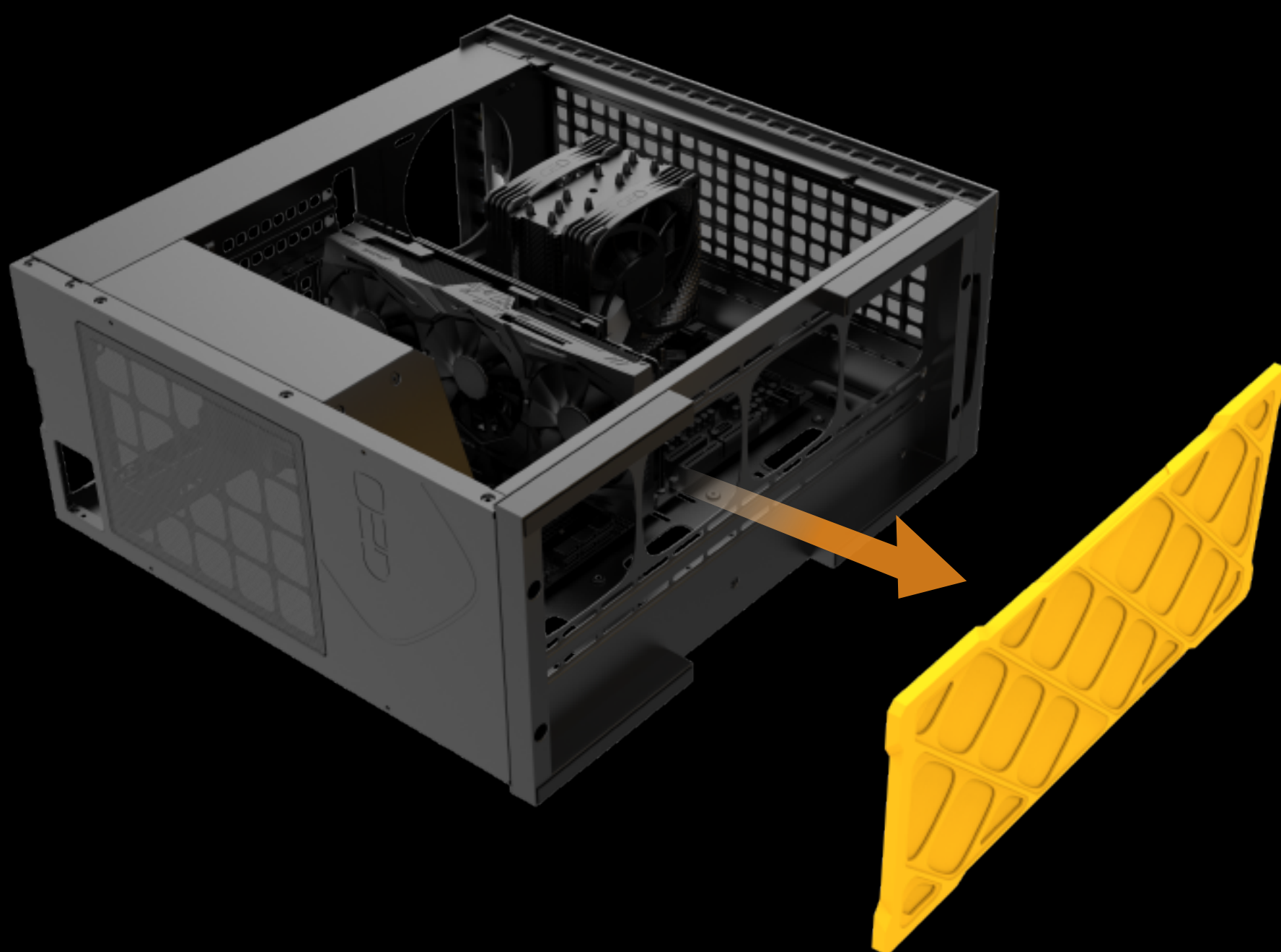



# HOW TO ASSEMBLE

## 安装步骤

**Step 2** 锁装风扇/水冷模组于机箱内(螺丝由风扇/水冷产品提供)

Mount the water cooler bracket and radiator.

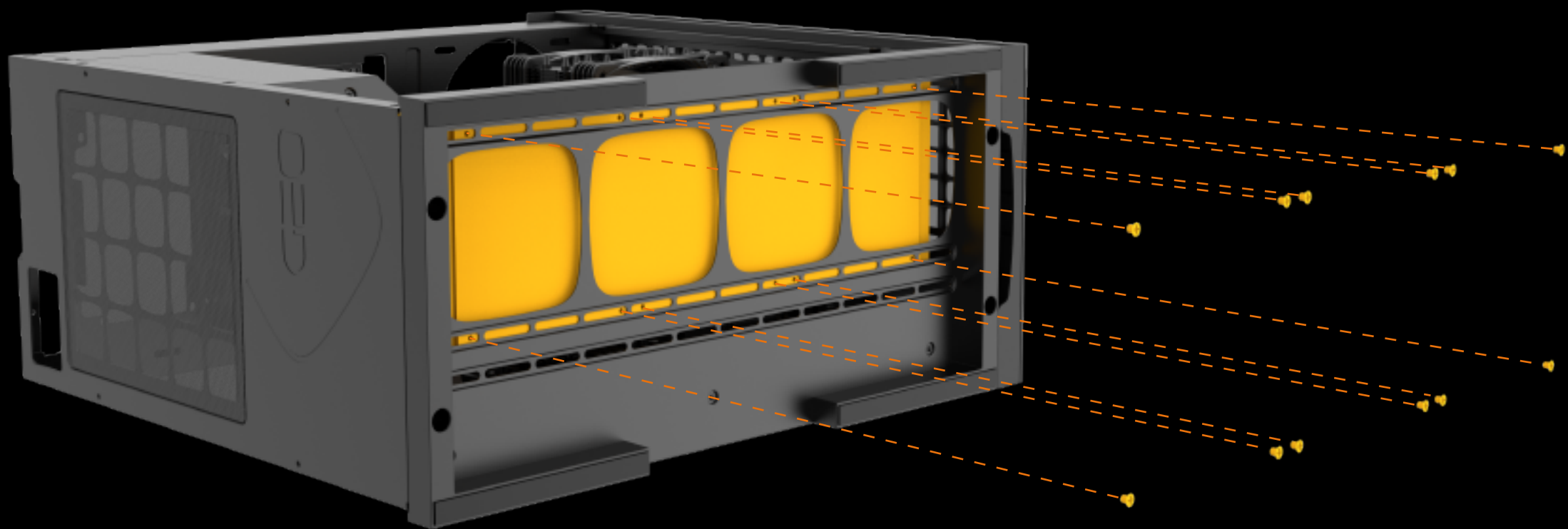

# HOW TO ASSEMBLE

## 安装步骤

- Step 3** 装回底部磁吸滤网  
Mount the water cooler bracket and radiator.

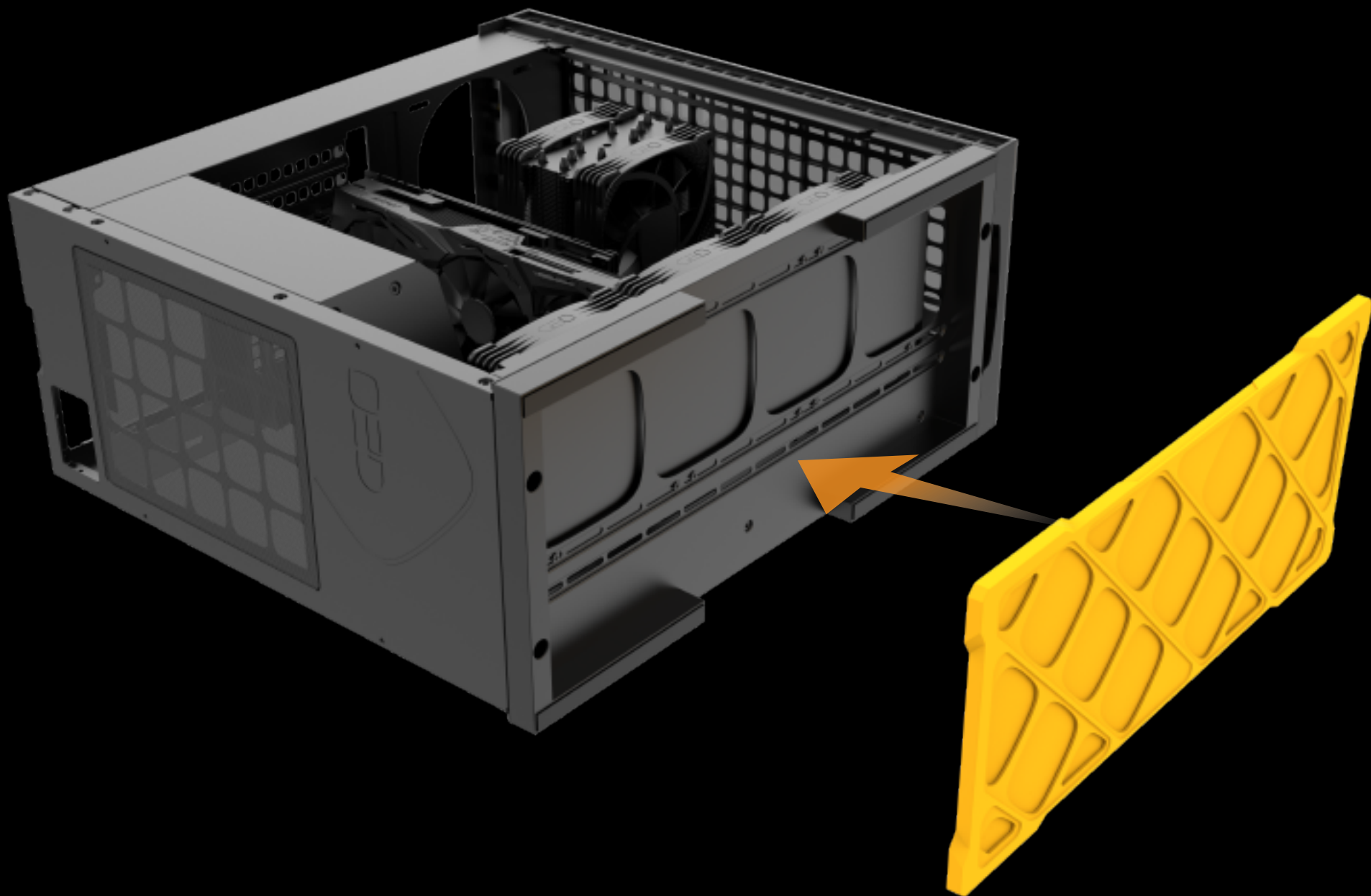

# HOW TO ASSEMBLE

## 安装步骤

GEOMETRIC  
FUTURE  
Modle 6 User Guide

- 8** 安装前部风扇/水冷  
Mount the top fan/water cooler

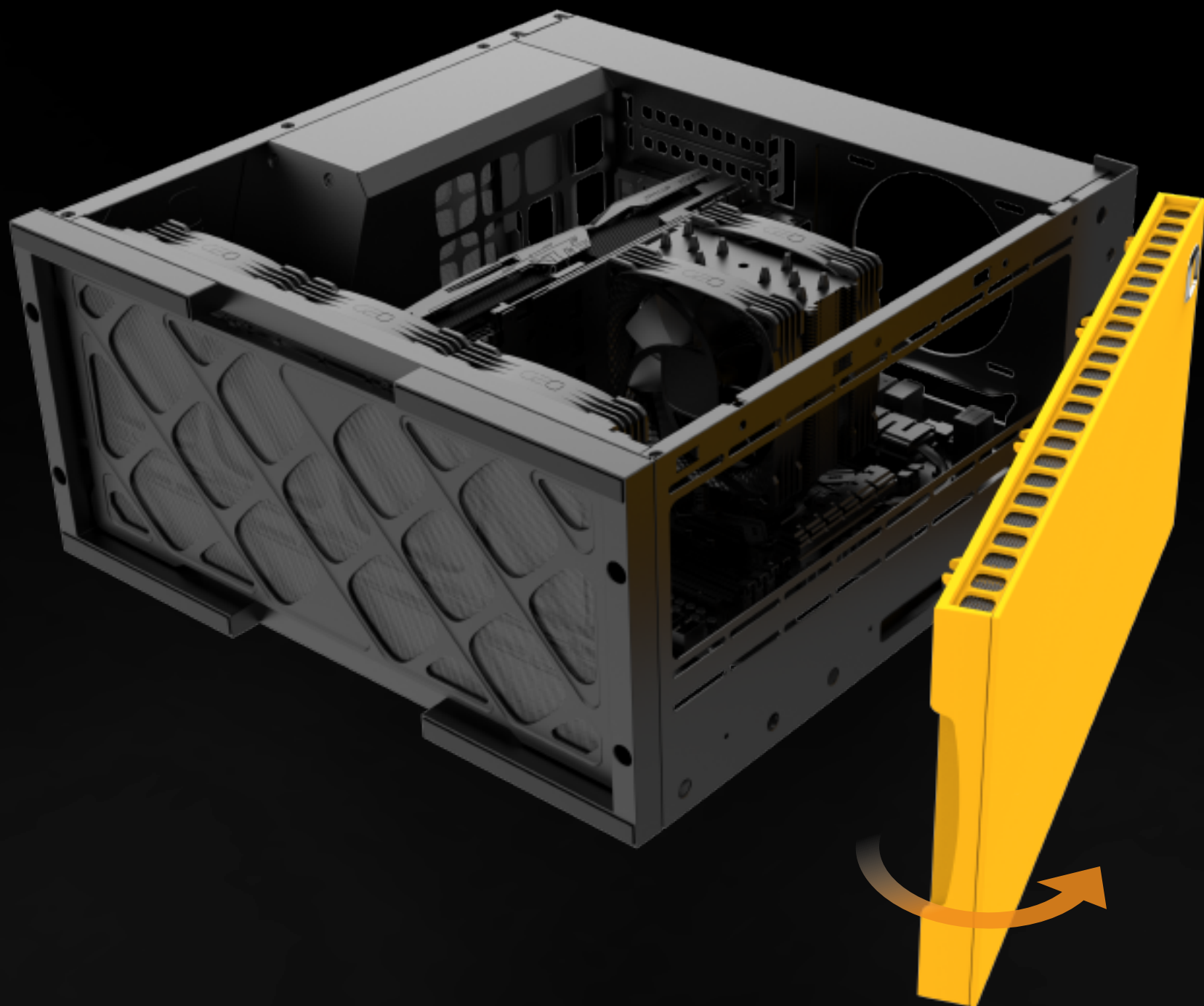

### Step 1

#### 拆取前置面板

Remove the front glass panel

# HOW TO ASSEMBLE

安装步骤

GEOMETRIC  
FUTURE  
Modle 6 User Guide



PH2

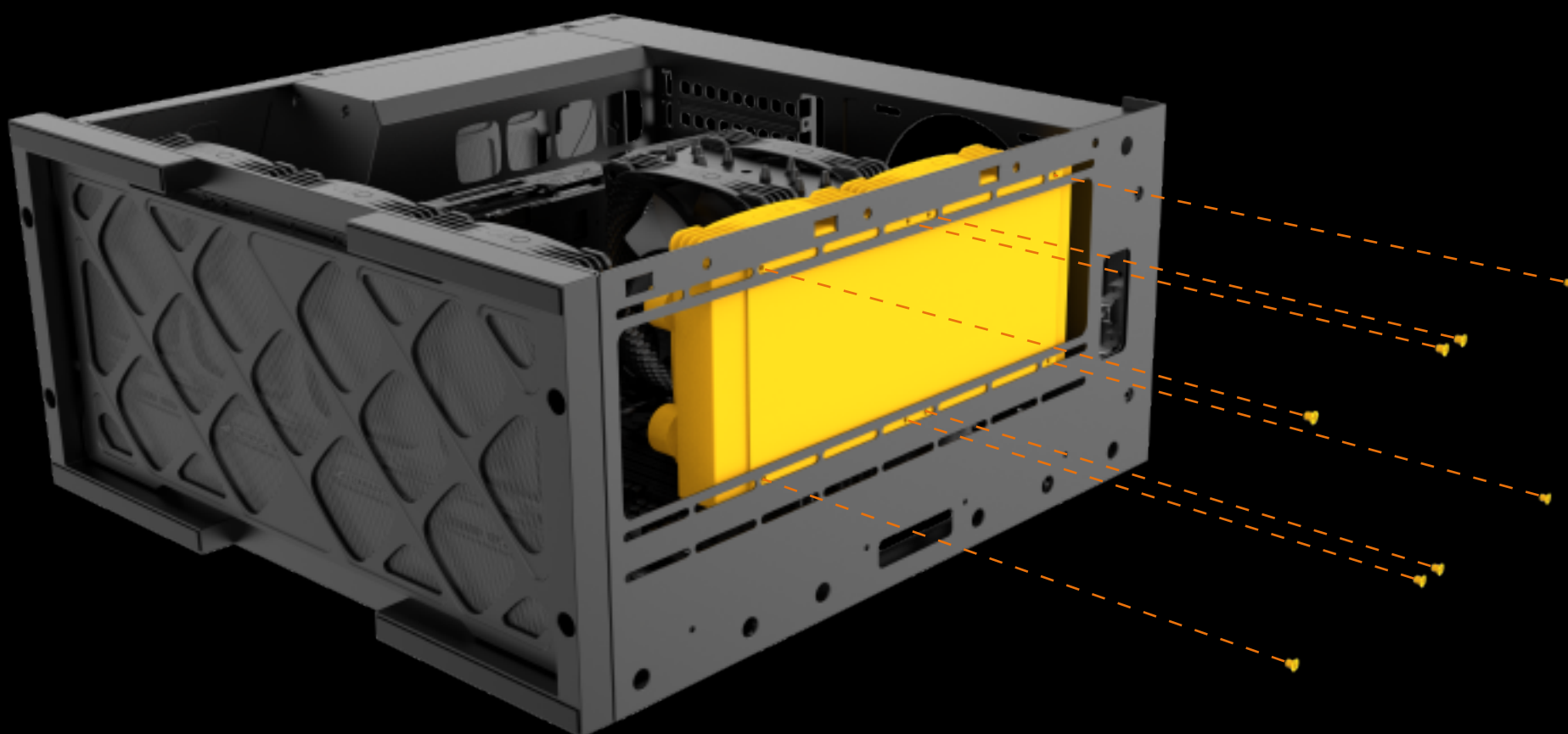

## Step 2

安装前板风扇/水冷

Install the front panel fan/water-cooling module

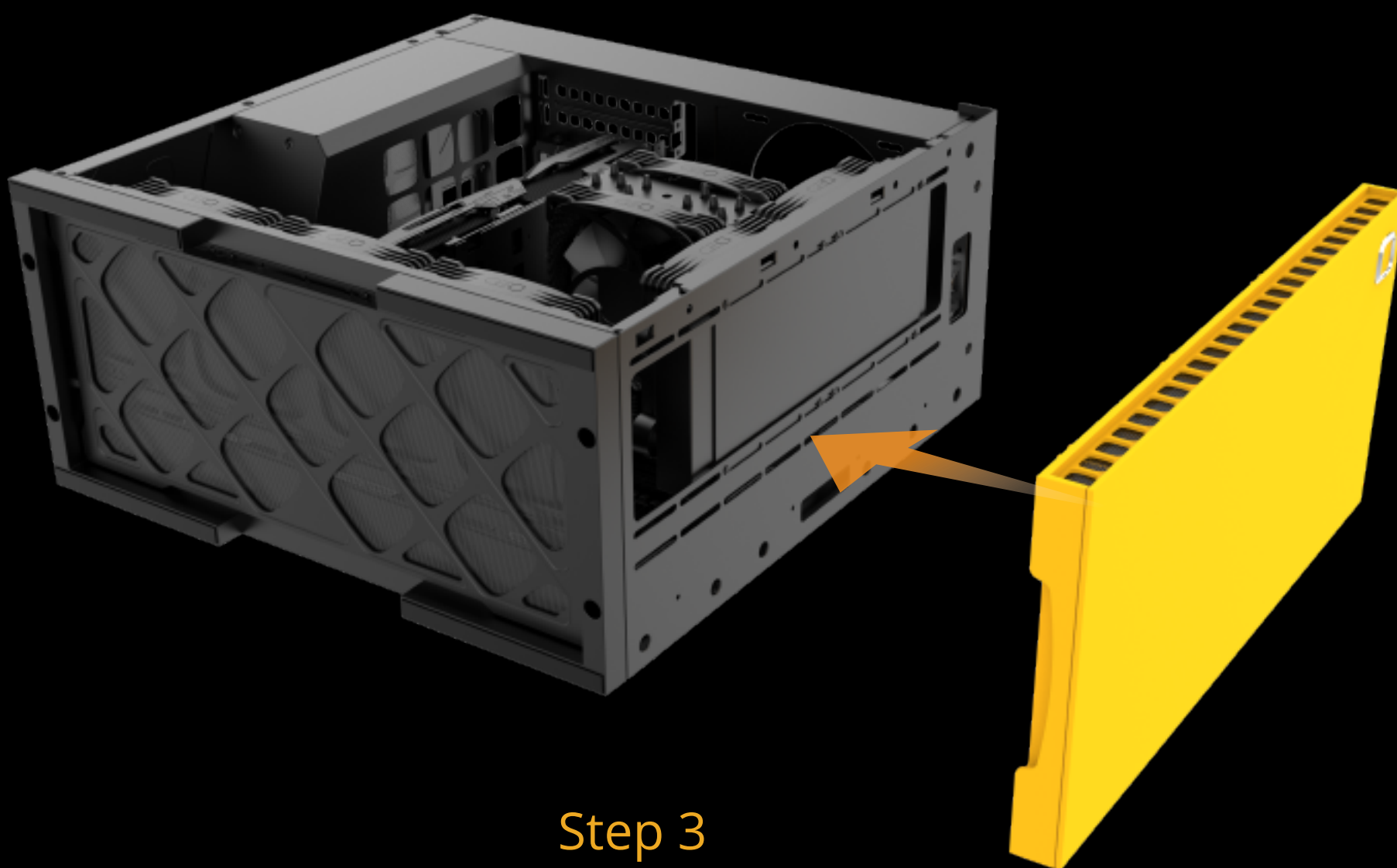

## Step 3

装回前置面板

Reinstall the front glass panel.

# HOW TO ASSEMBLE

## 安装步骤

GEO METRIC  
FUTURE  
Modle 6 User Guide

- 9** 安装顶部风扇/水冷 (螺丝由风扇/水冷产品提供)  
Install the power cord



PH2



X 4

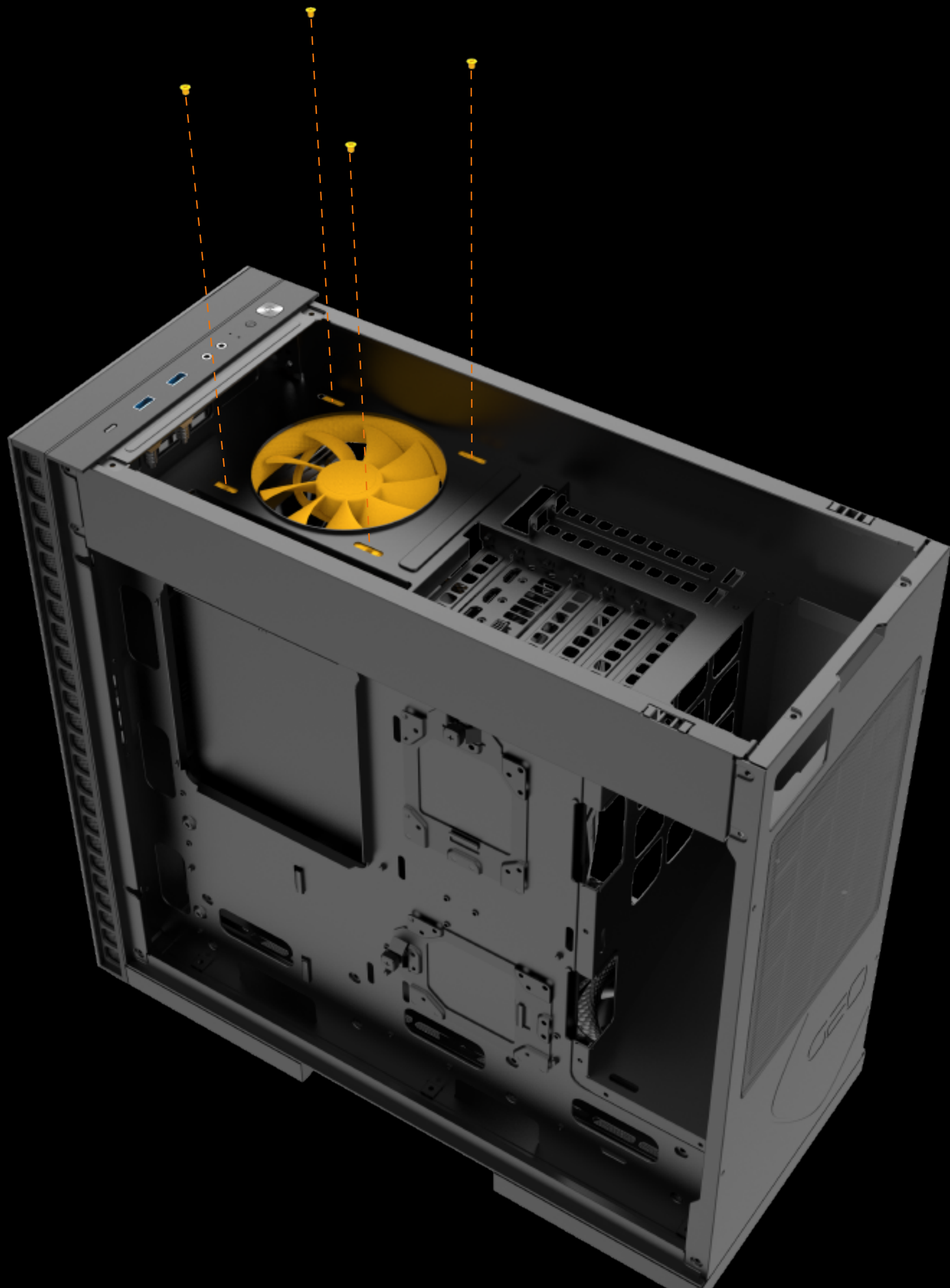

# HOW TO ASSEMBLE

## 安装步骤

### 10 锁装电源 Install the power cord

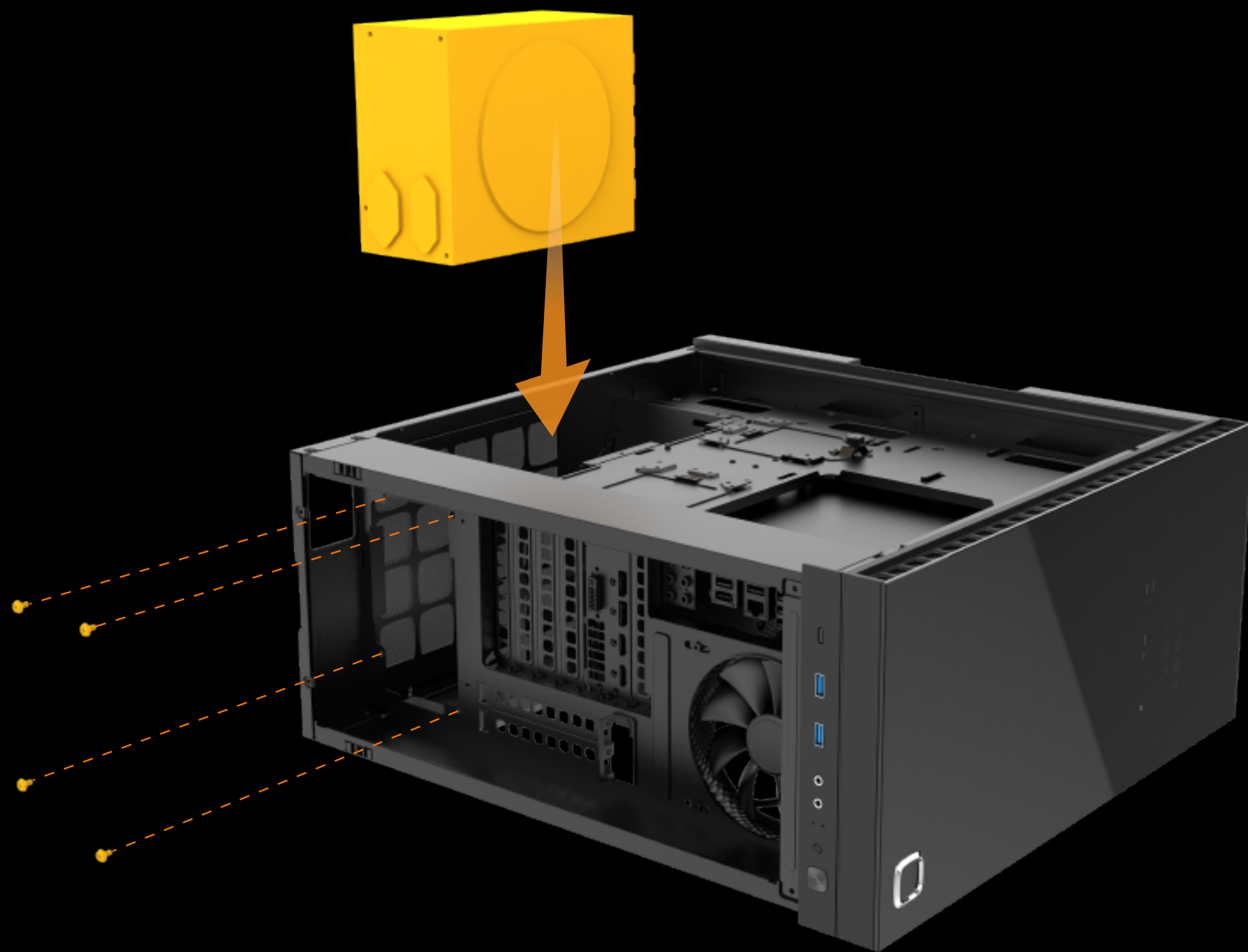

### 11 安装硬盘 (最多支持4组硬盘位 / 不同机种标配硬盘支架数量不等)

Install hard drive (support up to 6 hard drive brackets / different case models come with different number of hard drive brackets)



PH2



手拧螺丝 / 拆取硬盘支架

Screw by hand / Remove the hard drive bracket

# HOW TO ASSEMBLE

## 安装步骤

### 11 安装硬盘 Install hard drive

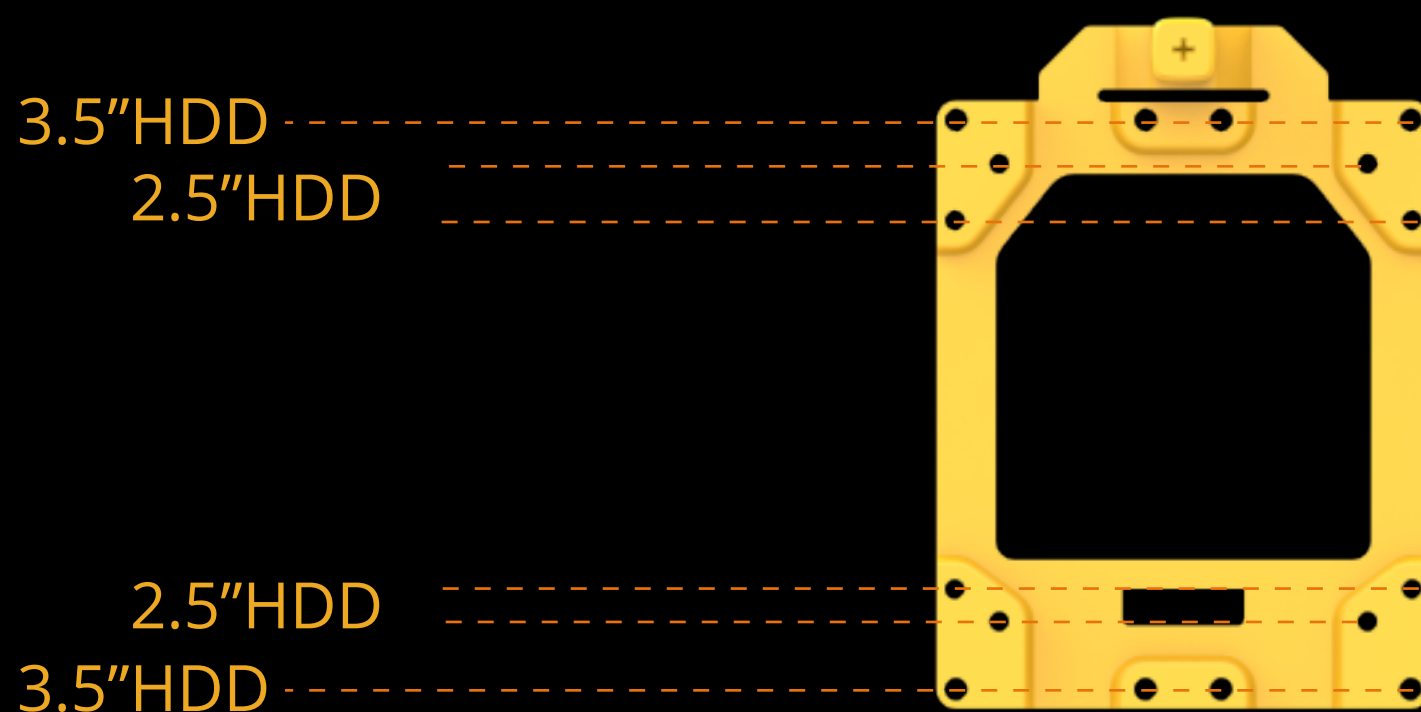

### 锁装2.5"HDD Mount the 2.5"HDD

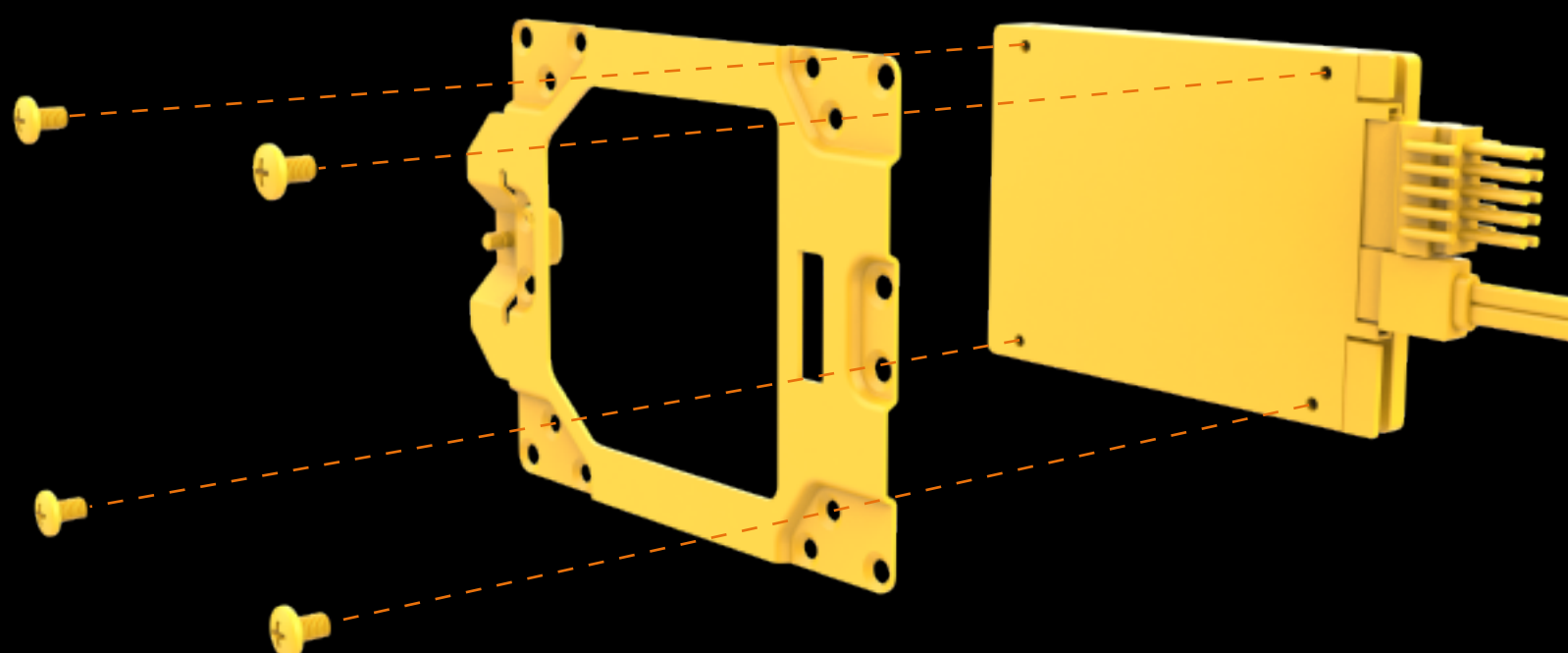



### 11 安装硬盘 Install hard drive

锁装3.5"HDD  
Mount the 3.5"HDD

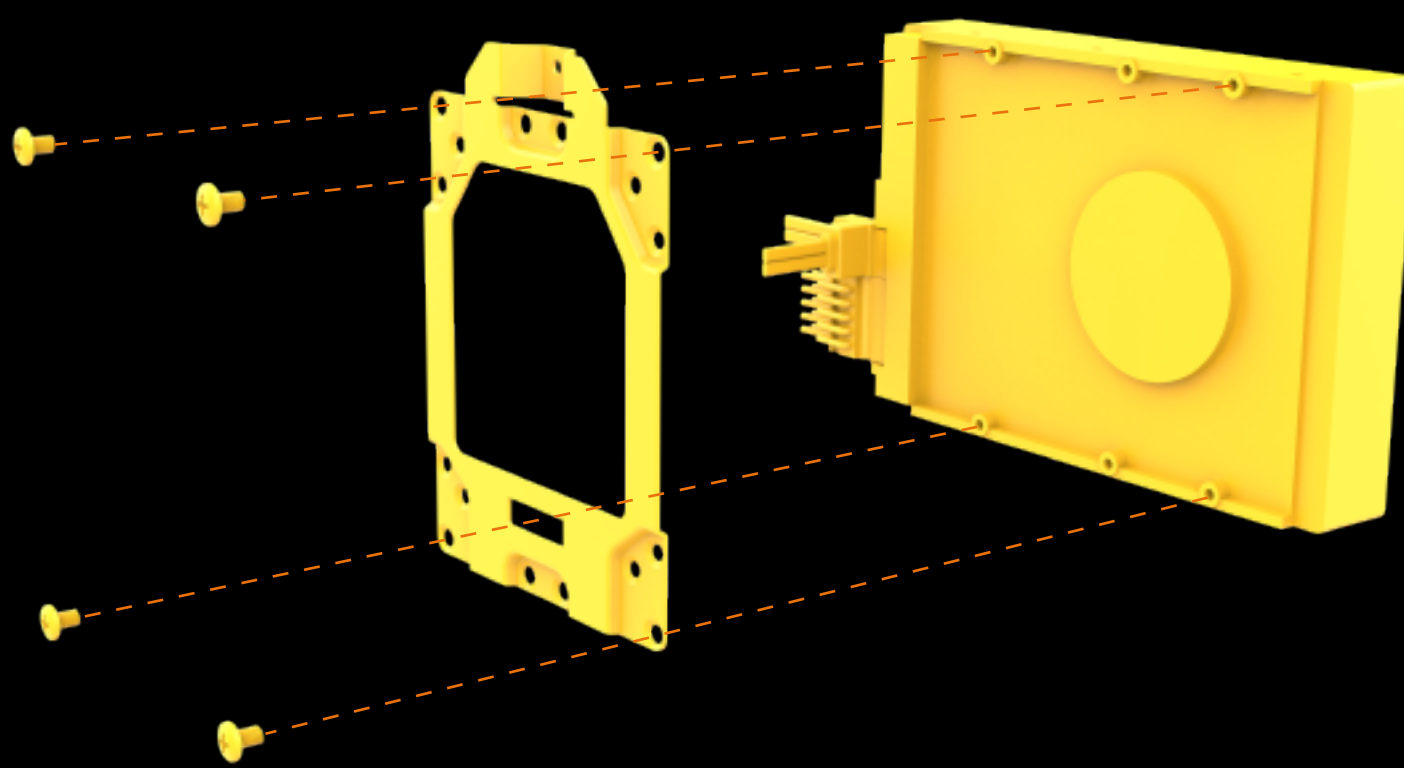

支架锁装硬盘支持多个方向选择  
Hard drive may be installed in several directions

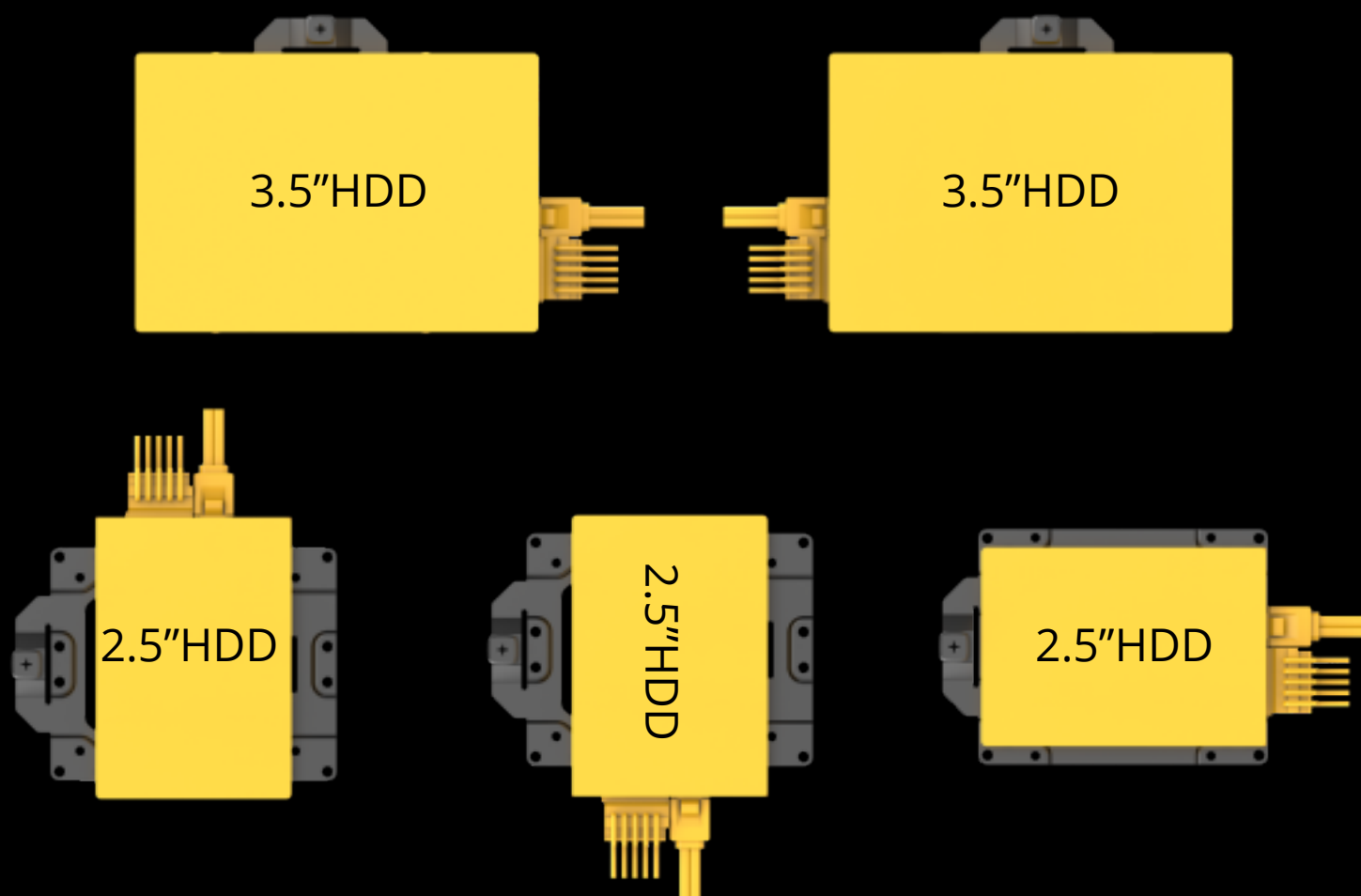

### 11 安装硬盘 Install hard drive



硬盘安装完成示意图

Schematic diagram of hard drive installation

- 12** 线材整理绑线位置 虚线为线材路径 黄色块为扎线位置  
Cable management & routing, where dotted line is wire routing and yellow block is cable bundle position

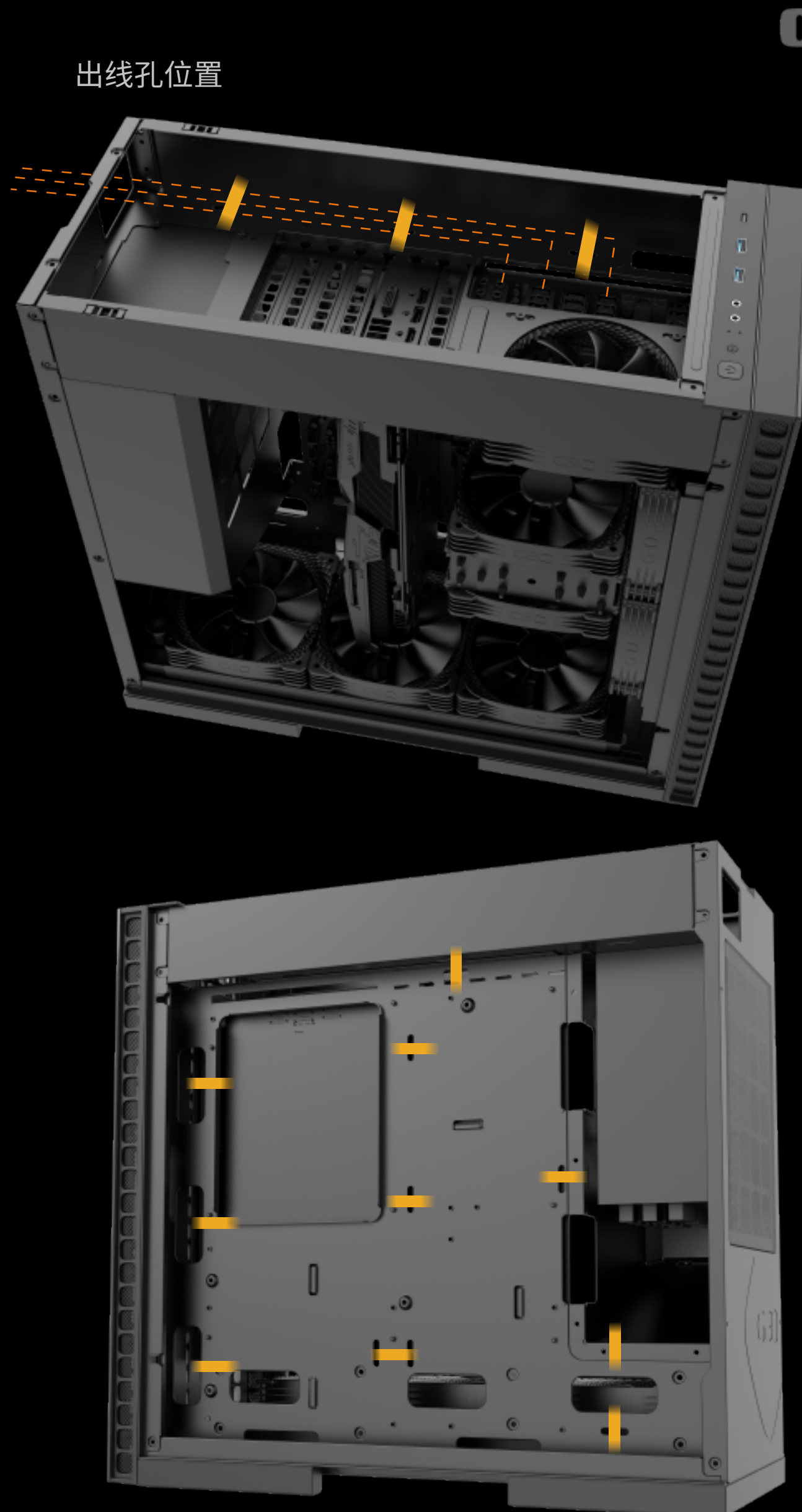

# HOW TO ASSEMBLE

## 安装步骤

- 13** 装回侧板与顶盖  
Put back the end panel and top panel



PH2

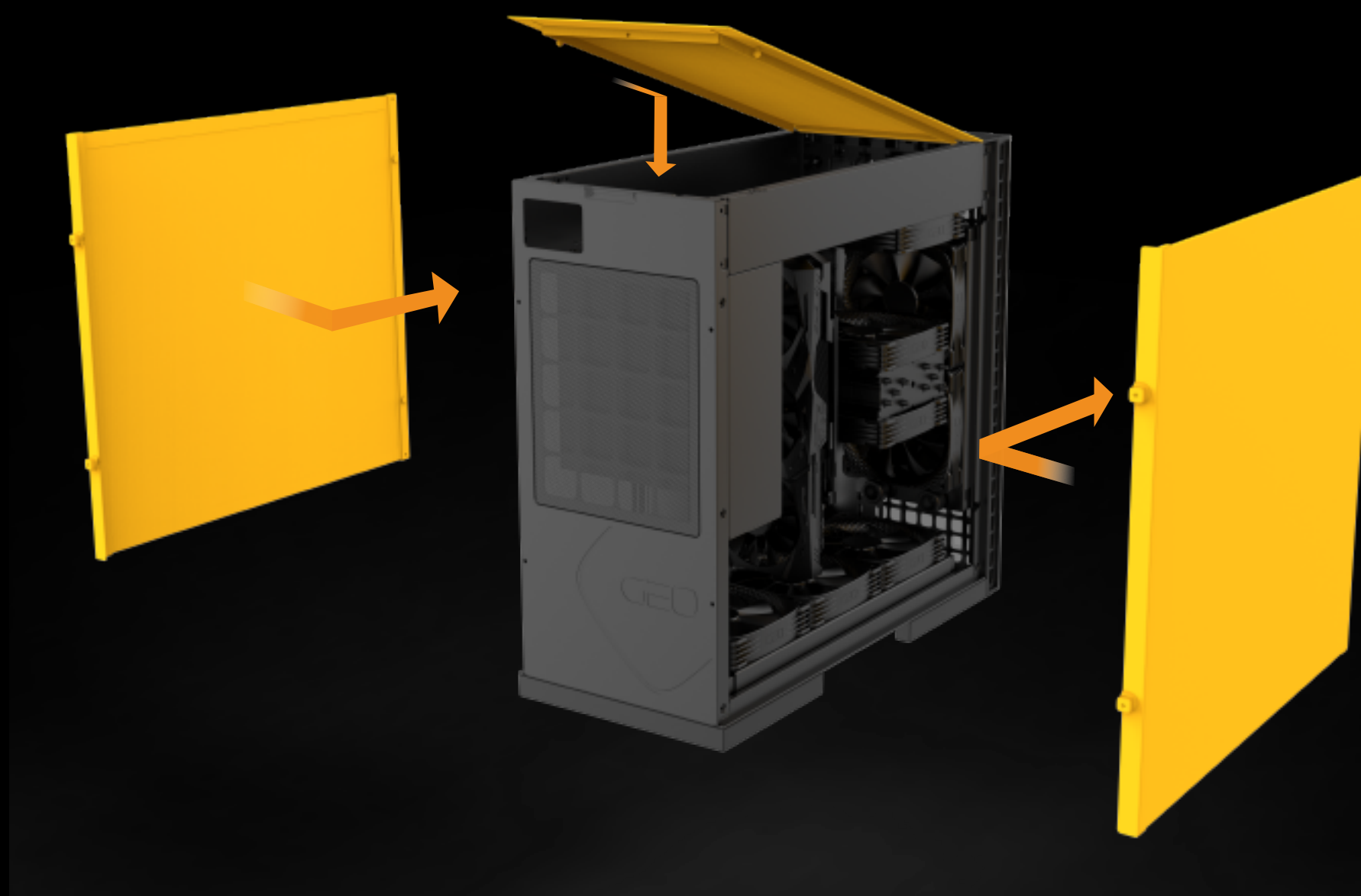

# FRONT I/O WIRING SCHEMATIC

## 前置I/O接线示意



PH2

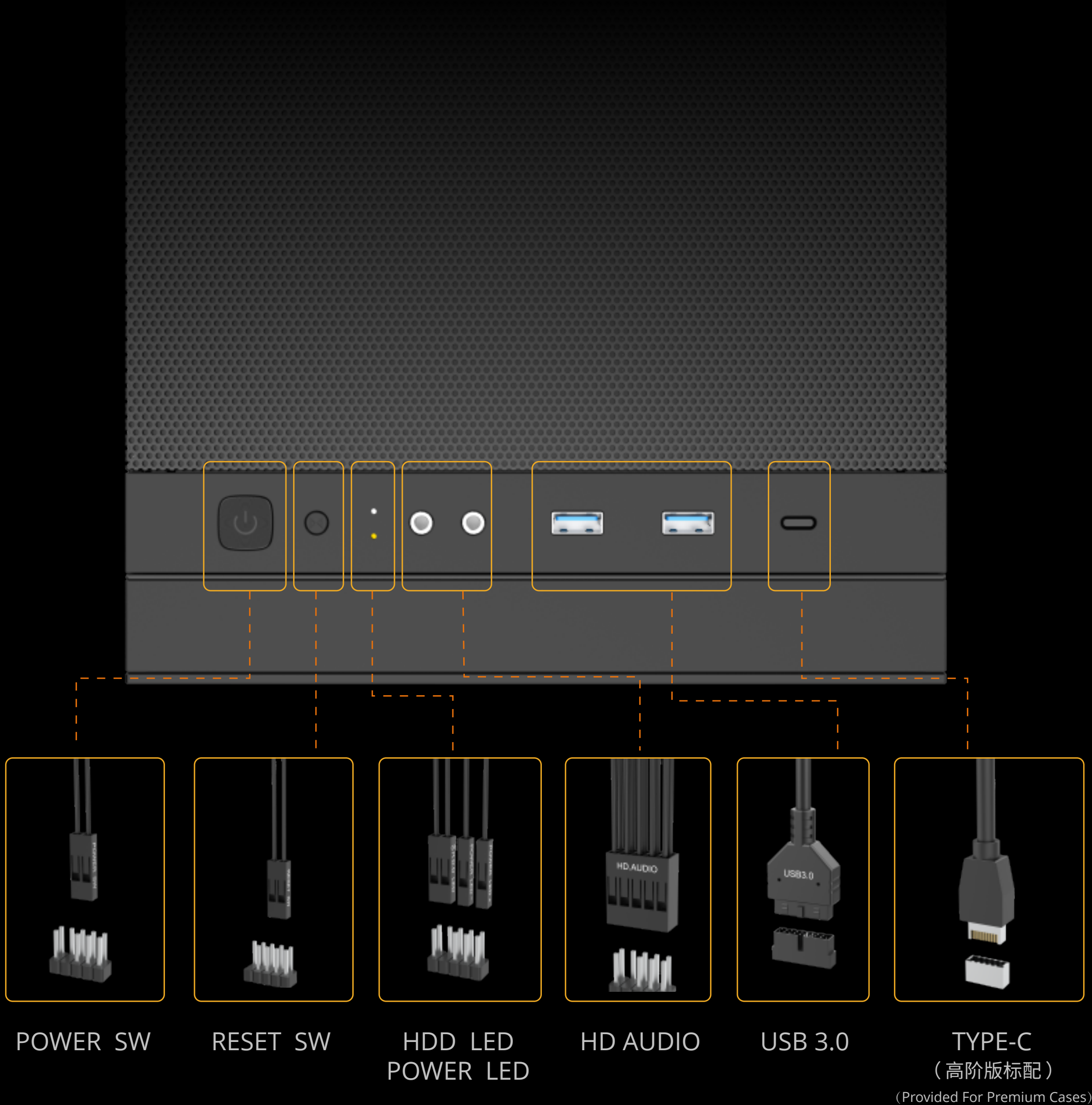

### 注意事项

- 1.请严格依照本使用手册所示步骤进行安装。
- 2.安装计算机产品过程中,请佩戴静电环及防护手套进行操作,须供电操作的产品或组件请严格遵照正确的接插方式及线序,否则可能导致计算机主板等硬件烧毁及人员损伤。
- 3.请勿将此产品用于指定范围以外的用途,且勿对本产品进行改装,以免导致本产品及相关组件的故障及损毁。
- 4.若要搬运本产品及内含物品,请先拆除本产品内所有组件后再进行操作,以免造成本产品及相关组件的损坏,并避免人员损伤。
- 5.若遇到产品组装或使用疑问,请及时咨询官方客服,以获得正确指导后进行操作。
- 6.若擅自违规组装造成本产品及各组件损坏,官方将仅做有偿维修及更换零组件。

1. Please assemble in strict accordance with the steps shown in this Manual.

2. In the process of installing computer products, please wear wrist strap and protective gloves. For products or components that are assembled powered on, the correct connection method and wiring sequence should be strictly followed, otherwise it may lead to the burn of computer motherboard and other hardware or personnel injury.

3. Do not use this product for any purpose beyond the specified use. Do not modify this product to avoid failure and damage to this product and related components.

4. If you want to handle this product and its contents, please remove all components inside this product first, so as to avoid damage to this product and related components, and avoid personal injury.

5. In case of any question about product assembly or use, please consult our customer service to obtain correct guidance before operating.

6. If the product and components are damaged due to unauthorized assembly, the manufacturer will only provide paid service to replace the components.

### 保修范围

1.本保修范围不包含:

- 以租赁为目的产品、人为损坏或未按正常用途及处理不当的产品。
- 因自然灾害导致产品受损的情况,包括雷击、火灾、水灾和地震等自然灾害。
- 产品序列号等原厂标识已修改或移除的产品。
- 未依照使用手册安装的产品。

2. 本产品保固范围及内容等相关信息,请至几何未来网站 [www.GeometricFuture.com](http://www.GeometricFuture.com) 查询。

3. 产品请以实际出货内容为准,苏州几何未来创意科技有限公司保留最终修改及解释权利。

1. This warranty does not cover:

- Products that are used for the purpose of leasing, artificially damaged, not used for normal purposes and improperly handled;
- Product damage caused by natural disasters, including lightning, fire, flood, earthquake and other natural disasters;
- Products whose original factory identification such as product serial number has been modified or removed;
- Products not installed according to the User Manual.

2. For information about the warranty coverage of this product, please visit Geometric Future's website [www.GeometricFuture.com](http://www.GeometricFuture.com),

3. The actual products may vary and the pictures shall serve as reference only. Suzhou Geometric Future Creative Technology Co., Ltd. reserves the right of final modification and interpretation.

www.GeometricFuture.com

# GEO METRIC FUTURE

SIMPLIFY YOUR FUTURE



wechat official account



Geometric Future website



Geometric Future weibo