

# **Acer LCD Monitor**

## **User Guide**

Copyright © 2022. Acer Incorporated.  
All Rights Reserved.

Acer LCD Monitor User Guide  
Original Issue: 04/2022

Changes may be made periodically to the information in this publication without obligation to notify any person of such revisions or changes. Such changes will be incorporated in new editions of this manual or supplementary documents and publications. This company makes no representations or warranties, either expressed or implied, with respect to the contents hereof and specifically disclaims the implied warranties of merchantability or fitness for a particular purpose.

Record the model number, serial number, purchase date and place of purchase information in the space provided below. The serial number and model number are recorded on the label affixed to your computer. All correspondence concerning your unit should include the serial number, model number and purchase information.

No part of this publication may be reproduced, stored in a retrieval system, or transmitted, in any form or by any means, electronically, mechanically, by photocopy, recording or otherwise, without the prior written permission of Acer Incorporated.

Acer LCD Monitor User Guide

Model number: \_\_\_\_\_

Serial number: \_\_\_\_\_

Date of purchase: \_\_\_\_\_

Place of purchase: \_\_\_\_\_

Acer and the Acer logo are registered trademarks of Acer Incorporated. Other companies' product names or trademarks are used herein for identification purposes only and belong to their respective companies.

# Information for your safety and comfort

## Safety instructions

Read these instructions carefully. Keep this document for future reference. Follow all warnings and instructions marked on the product.

Acer monitor is purposed for video and visual display of information obtained from electronic devices.

## Special notes on LCD monitors

The following are normal with the LCD monitor and do not indicate a problem.

- Due to the nature of the fluorescent light, the screen may flicker during initial use. Turn off the power switch and then turn it on again to make sure the flicker disappears.
- You may find slightly uneven brightness on the screen depending on the desktop pattern you use.
- The LCD screen has 99.99% or more effective pixels. It may include blemishes of 0.01% or less such as a missing pixel or pixel lit all the time.
- Due to the nature of the LCD screen, an afterimage of the previous screen may remain after switching the image, when the same image is displayed for hours. In this case, the screen is recovered slowly by changing the image or turning off the power switch for a few hours.

## Cleaning your monitor

Please carefully follow these guidelines when cleaning the monitor:

- Always unplug the monitor before cleaning.
- Use a soft cloth to wipe the screen and cabinet front and sides.

## Accessibility

Be sure that the power outlet you plug the power cord into is easily accessible and located as close to the equipment operator as possible. When you need to disconnect power from the equipment, be sure to unplug the power cord from the electrical outlet.

## Safe listening

To protect your hearing, follow these instructions.

- Gradually increase the volume until you can hear it clearly and comfortably and without distortion.
- After setting the volume level, do not increase it after your ears have adjusted.
- Limit the amount of time listening to music at high volume.
- Avoid turning up the volume to block out noisy surroundings.
- Turn the volume down if you can't hear people speaking near you.

## Warnings

- Do not use this product near water.
- Do not place this product on an unstable cart, stand or table. If the product falls, it could be seriously damaged.
- Slots and openings are provided for ventilation to ensure reliable operation of the product and to protect it from overheating. These openings must not be blocked or covered. The openings should never be blocked by placing the product on a bed, sofa, rug or other similar surface. This product should never be placed near or over a radiator or heat register, or in a built-in installation unless proper ventilation is provided.
- Never push objects of any kind into this product through cabinet slots as they may touch dangerous voltage points or short-out parts that could result in a fire or electric shock. Never spill liquid of any kind onto or into the product.
- To avoid damage of internal components and to prevent battery leakage, do not place the product on a vibrating surface.
- Never use it under sporting, exercising, or any vibrating environment which will probably cause unexpected short current or damage internal devices.

## Using electrical power

- This product should be operated from the type of power indicated on the marking label. If you are not sure of the type of power available, consult your dealer or local power company.
- Do not allow anything to rest on the power cord. Do not locate this product where people will walk on the cord.

- If an extension cord is used with this product, make sure that the total ampere rating of the equipment plugged into the extension cord does not exceed the extension cord ampere rating. Also, make sure that the total rating of all products plugged into the wall outlet does not exceed the fuse rating.
- Do not overload a power outlet, strip or receptacle by plugging in too many devices. The overall system load must not exceed 80% of the branch circuit rating. If power strips are used, the load should not exceed 80% of the power strip's input rating.
- This product's power cord is equipped with a three-wire grounded plug. The plug only fits in a grounded power outlet. Make sure the power outlet is properly grounded before inserting the power cord plug. Do not insert the plug into a non-grounded power outlet. Contact your electrician for details.



.....

**Warning! The grounding pin is a safety feature. Using a power outlet that is not properly grounded may result in electric shock and/or injury.**



.....

**Note:** The grounding pin also provides good protection from unexpected noise produced by other nearby electrical devices that may interfere with the performance of this product.

- Use the product only with the supplied power supply cord set. If you need to replace the power cord set, make sure that the new power cord meets the following requirements: detachable type, UL listed/CSA certified, type SPT-2, rated 7 A 125 V minimum, VDE approved or its equivalent, 4.6 meters (15 feet) maximum length.

## Product servicing

Do not attempt to service this product yourself, as opening or removing covers may expose you to dangerous voltage points or other risks. Refer all servicing to qualified service personnel.

Unplug this product from the wall outlet and refer servicing to qualified service personnel when:

- the power cord or plug is damaged, cut or frayed
- liquid was spilled into the product
- the product was exposed to rain or water
- the product has been dropped or the case has been damaged
- the product exhibits a distinct change in performance, indicating a need for service
- the product does not operate normally after following the operating instructions



**Note:** Adjust only those controls that are covered by the operating instructions, since improper adjustment of other controls may result in damage and will often require extensive work by a qualified technician to restore the product to normal condition.

## Potentially explosive environments

Switch off your device in any area with a potentially explosive atmosphere and obey all signs and instructions. Potentially explosive atmospheres include areas where you would normally be advised to turn off your vehicle engine. Sparks in such areas could cause an explosion or fire resulting in bodily injury or even death. Switch off the device near depots, storage and distribution areas; chemical plants; or where blasting operations are in progress. Areas with a potentially explosive atmosphere are often, but not always, marked. They include below deck on boats, chemical transfer or storage facilities, vehicles using liquefied petroleum gas (such as propane or butane), and areas where the air contains chemicals or particles such as grain, dust or metal powders.

## Additional safety information

Your device and its enhancements may contain small parts. Keep them out of the reach of small children.

## IT Equipment Recycling Information

Acer is strongly committed to environmental protection and views recycling, in the form of salvaging and disposal of used equipment, as one of the company's top priorities in minimizing the burden placed on the environment.

We at Acer are very conscious of the environmental effects of our business and strive to identify and provide the best working procedures to reduce the environmental impact of our products.

For more information and help when recycling, please go to this website:

<https://www.acer-group.com/sustainability/en/our-products-environment.html>

Visit [www.acer-group.com](http://www.acer-group.com) for further information on the features and benefits of our other products.

## Disposal instructions



Do not throw this electronic device into the trash when discarding. To minimize pollution and ensure utmost protection of the global environment, please recycle. For more information on the Waste from Electrical and Electronics Equipment (WEEE) regulations, visit <https://www.acer-group.com/sustainability/en/our-products-environment.html>

## LCD pixel statement

The LCD unit is produced with high-precision manufacturing techniques. Nevertheless, some pixels may occasionally misfire or appear as black or red dots. This has no effect on the recorded image and does not constitute a malfunction.

This product has been shipped enabled for power management:

- Activate display's Sleep mode within 5 minutes of user inactivity.
- Wake the monitor when it is in Active Off mode, move the mouse or press any keyboard key.

## Tips and information for comfortable use

Computer users may complain of eyestrain and headaches after prolonged use. Users are also at risk of physical injury after long hours of working in front of a computer. Long work periods, bad posture, poor work habits, stress, inadequate working conditions, personal health and other factors greatly increase the risk of physical injury.

Incorrect computer usage may lead to carpal tunnel syndrome, tendonitis, tenosynovitis or other musculoskeletal disorders. The following symptoms may appear in the hands, wrists, arms, shoulders, neck or back:

- numbness, or a burning or tingling sensation
- aching, soreness or tenderness
- pain, swelling or throbbing
- stiffness or tightness
- coldness or weakness

If you have these symptoms, or any other recurring or persistent discomfort and/or pain related to computer use, consult a physician immediately and inform your company's health and safety department.

The following section provides tips for more comfortable computer use.

## Finding your comfort zone

Find your comfort zone by adjusting the viewing angle of the monitor, using a footrest, or raising your sitting height to achieve maximum comfort. Observe the following tips:

- refrain from staying too long in one fixed posture
- avoid slouching forward and/or leaning backward
- stand up and walk around regularly to remove the strain on your leg muscles

## Taking care of your vision

Long viewing hours, wearing incorrect glasses or contact lenses, glare, excessive room lighting, poorly focused screens, very small typefaces and low-contrast displays could stress your eyes. The following sections provide suggestions on how to reduce eyestrain.

### Eyes

- Rest your eyes frequently.
- Give your eyes regular breaks by looking away from the monitor and focusing on a distant point.
- Blink frequently to keep your eyes from drying out.

### Display

- Keep your display clean.
- Keep your head at a higher level than the top edge of the display so your eyes point downward when looking at the middle of the display.
- Adjust the display brightness and/or contrast to a comfortable level for enhanced text readability and graphics clarity.
- Eliminate glare and reflections by:
  - placing your display in such a way that the side faces the window or any light source
  - minimizing room light by using drapes, shades or blinds
  - using a task light
  - changing the display's viewing angle
  - using a glare-reduction filter
  - using a display visor, such as a piece of cardboard extended from the display's top front edge
- Avoid adjusting your display to an awkward viewing angle.
- Avoid looking at bright light sources, such as open windows, for extended periods of time.

## Developing good work habits

Develop the following work habits to make your computer use more relaxing and productive:

- Take short breaks regularly and often.
- Perform some stretching exercises.
- Breathe fresh air as often as possible.
- Exercise regularly and maintain a healthy body.





## Declaration of Conformity

We,

**Acer Incorporated**

8F, 88, Sec. 1, Xintai 5th Rd., Xizhi, New Taipei City 221

And,

**Acer Italy s.r.l.**

Viale delle Industrie 1/A, 20044 Arese (MI), Italy

Tel: +39-02-939-921 ,Fax: +39-02 9399-2913

www.acer.it

<b>Product:</b>	<b>LCD Monitor</b>
<b>Trade Name:</b>	<b>Acer</b>
<b>Model Number:</b>	<b>B278U</b>
<b>SKU Number:</b>	<b>B278U   xxxxxx;</b>
	<b>("x" = 0~9, a~z, A~Z, or blank)</b>

We, Acer Incorporated, hereby declare under our sole responsibility that the product described above is in conformity with the relevant Union harmonization legislations as below Directive and following harmonized standards and/or other relevant standards have been applied:

**EMC Directive: 2014/30/EU**

EN 55032:2015+A11:2020 Class B

EN 61000-3-3:2013+A1:2019

EN 55035:2017+A11:2020

EN 61000-3-2:2014 Class D

**LVD Directive: 2014/35/EU**

EN 62368-1: 2014+A11:2017

**RoHS Directive: 2011/65/EU**

EN IEC 63000: 2018

**ErP Directive: 2009/125/EC**

Regulation (EU) 2019/2021;EN50564:2011;EN62087

Year to begin affixing CE marking: 2022.

**RU Jan / Sr. Manager**  
**Acer Incorporated (New Taipei City)**

Apr.20,2022

Date

**acer**

**Acer America Corporation**  
333 West San Carlos St., San Jose  
Suite 1500  
CA 95110, U. S. A.  
Tel : 254-298-4000  
Fax : 254-298-4147  
www.acer.com



## Federal Communications Commission Supplier's Declaration of Conformity

This device complies with Part 15 of the FCC Rules. Operation is subject to the following two conditions: (1) this device may not cause harmful interference, and (2) this device must accept any interference received, including interference that may cause undesired operation.

The following local Manufacturer /Importer is responsible for this declaration:

<b>Product:</b>	<b>LCD Monitor</b>
<b>Model Number:</b>	<b>B278U</b>
<b>SKU Number:</b>	<b>B278U xxxxxx;</b> <b>("x" = 0~9, a ~ z, A ~ Z, or blank)</b>
<b>Name of Responsible Party:</b>	<b>Acer America Corporation</b>
<b>Address of Responsible Party:</b>	<b>333 West San Carlos St.</b> <b>Suite 1500</b> <b>San Jose, CA 95110</b> <b>U. S. A.</b>
<b>Contact Person:</b>	<b>Acer Representative</b>
<b>Phone No.:</b>	<b>254-298-4000</b>
<b>Fax No.:</b>	<b>254-298-4147</b>



### **ENERGY STAR®**

Acer's ENERGY STAR qualified products save you money by reducing energy costs and helps protect the environment without sacrificing features or performance. Acer is proud to offer our customers products with the ENERGY STAR mark.

### **What is ENERGY STAR?**

Products that are ENERGY STAR qualified use less energy and prevent greenhouse gas emissions by meeting strict energy efficiency guidelines set by the

U.S. Environmental Protection Agency. Acer is committed to offer products and services worldwide that help customers save money, conserve energy and improve the quality of our environment. The more energy we can save through energy efficiency, the more we reduce greenhouse gases and the risks of climate change. More information refers to <http://www.energystar.gov>.

### **Acer ENERGY STAR qualified products:**

- Produce less heat and reduce cooling loads, and warmer climates.
- Automatically go into "display sleep" within 5 minutes of inactivity.
- Wake the monitor when it is in Active Off mode, move the mouse or press any keyboard key.

ENERGY STAR and the ENERGY STAR mark are registered U.S. marks



**Note:** This product qualifies for ENERGY STAR in the factory default settings which can be restored by "Factory Reset" function in the OSD menu.

Changing the factory default settings or enabling other features may increase power consumption that could exceed the ENERGY STAR specified limit.

# TCO Certified

A third-party certification according to ISO 14024



Toward sustainable IT products

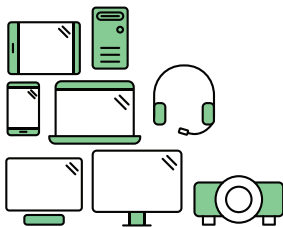

## Say hello to a more sustainable product

IT products are associated with a wide range of sustainability risks throughout their life cycle. Human rights violations are common in the factories. Harmful substances are used both in products and their manufacture. Products can often have a short lifespan because of poor ergonomics, low quality and when they are not able to be repaired or upgraded.

**This product is a better choice.** It meets all the criteria in TCO Certified, the world's most comprehensive sustainability certification for IT products. Thank you for making a responsible product choice, that help drive progress towards a more sustainable future!

Criteria in TCO Certified have a life-cycle perspective and balance environmental and social responsibility. Conformity is verified by independent and approved verifiers that specialize in IT products, social responsibility or other sustainability issues. Verification is done both before and after the certificate is issued, covering the entire validity period. The process also includes ensuring that corrective actions are implemented in all cases of factory non-conformities. And last but not least, to make sure that the certification and independent verification is accurate, both TCO Certified and the verifiers are reviewed regularly.

### Want to know more?

Read information about TCO Certified, full criteria documents, news and updates at [tcocertified.com](https://tcocertified.com). On the website you'll also find our Product Finder, which presents a complete, searchable listing of certified products.

# Contents

<b>Information for your safety and comfort</b>	<b>3</b>
Safety instructions	3
Special notes on LCD monitors	3
Cleaning your monitor	3
Accessibility	4
Safe listening	4
Warnings	4
Using electrical power	4
Product servicing	5
Potentially explosive environments	6
Additional safety information	6
IT Equipment Recycling Information	6
Disposal instructions	6
LCD pixel statement	7
Tips and information for comfortable use	7
Finding your comfort zone	7
Taking care of your vision	8
Developing good work habits	8
Federal Communications Commission	
Supplier's Declaration of Conformity	10
TCO Certified	12
<b>Unpacking</b>	<b>14</b>
<b>Connecting the Power cord</b>	<b>17</b>
<b>Power saving</b>	<b>17</b>
Display Data Channel (DDC)	18
19-pin color display signal cable*	18
20-pin color display signal cable*	18
24-pin USB 3.1 Type C cable	19
Standard timing table	20
<b>Installation</b>	<b>21</b>
<b>Daisy-chain function</b>	<b>22</b>
<b>User Controls</b>	<b>23</b>
<b>Troubleshooting</b>	<b>36</b>
DP/HDMI Mode (Optional)	36

# Unpacking

Please check that the following items are present when you unpack the box, and save the packing materials in case you need to ship or transport the monitor in the future.

LCD monitor

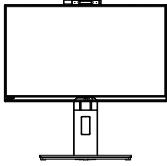

Quick start guide



\*HDMI Cable  
(Optional)



\*DP Cable  
(Optional)

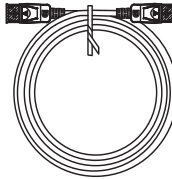

\*AC Power cord

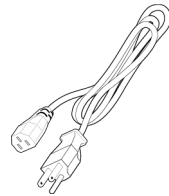

\*USB Type C cable  
(Optional)

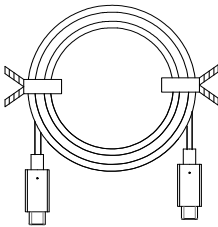

\*USB cable  
(Optional)

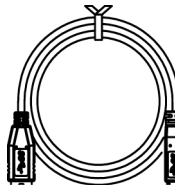

\*Microphone  
(Optional)



\*Also the Replaceable parts required by the TCO Certified.

\*Type-c power support profile 3A at 5V,9V,15V; 5A at 20V

\*IR webcam feature depends on model, sku and/or region.

# SCREEN POSITION ADJUSTMENT

In order to optimize the best viewing position, you can adjust the tilt of the monitor.

- **Attaching the Base**

Note: Remove the monitor and monitor base from its packaging. Carefully place the monitor face-down on a stable surface -- use a cloth to avoid scratching the screen.

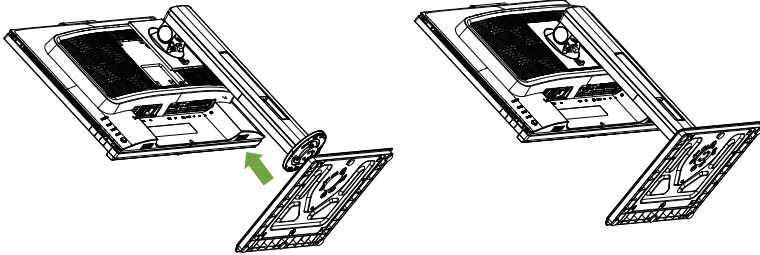

- **Tilt**

Please see the illustration below for an example of the tilt range.

Only at the highest point can 35 degrees of recline be offered for the angle of elevation.

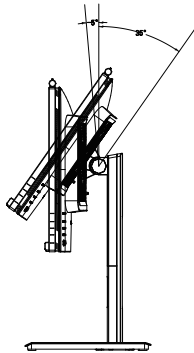

## • Height Adjustment

After pressing the top of the monitor then you can adjust the height of the monitor.

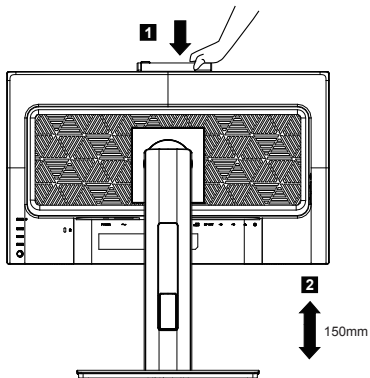

## • Swivel

With the built-in pedestal, you can swivel the monitor for the most comfortable viewing angle.

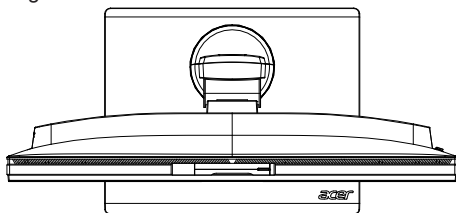

## • Monitor Pivot

Before rotating the display, lift it to the top position and then push it back to the utmost degree. Rotate clockwise until the monitor stops at  $90^{\circ}$ .

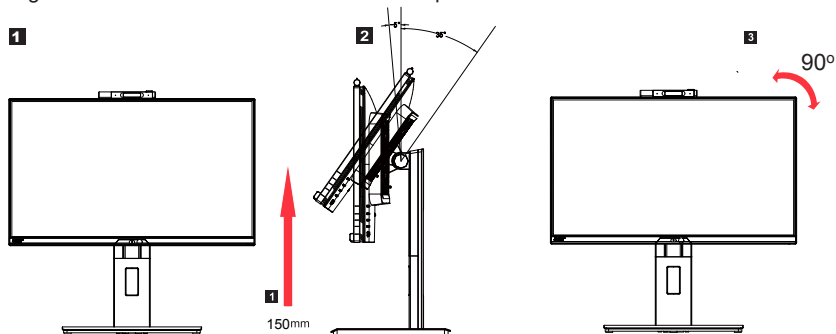



## Connecting the Power cord

- Check first to make sure that the power cord you use is the correct type required for your area.
- The monitor has a universal power supply that allows operation in either 100/120 V AC or 220/240 V AC voltage area. No user-adjustment is required.
- Plug one end of the AC power cord to the Adapter, and plug the other end into an AC outlet.
- For units using 120 V AC:  
Use a UL-listed cord set, type SVT wire and plug rated 10 A/125 V.
- For units using 220/240 V AC:  
Use a cord set consisting of H05VV-F cord and plug rated 10 A/250 V. The cord set should have the appropriate safety approvals for the country in which the equipment will be installed.

## Power saving

The monitor will be driven into "Power Saving" mode by the control signal from the display controller, as indicated by the amber-color power LED.

State	LED Light
ON	Blue
Power Saving Mode	Amber

The power saving states will be kept until a control signal has been detected or the keyboard or mouse is activated. The recovery time from Active OFF state back to ON state is around 3 seconds.

## Display Data Channel (DDC)

To make installation easier, so long as your system supports the DDC protocol, the monitor is able to plug-and-play. The DDC is a communication protocol through which the monitor automatically informs the host system about its capabilities; for example, supported resolutions and corresponding timing. The monitor supports the DDC2B standard.

### 19-pin color display signal cable\*

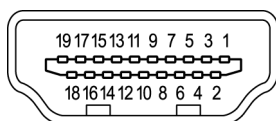

PIN No.	Description	PIN No.	Description
1	TMDS Data2+	2	TMDS Data2 Shield
3	TMDS Data2-	4	TMDS Data1+
5	TMDS Data1 Shield	6	TMDS Data1-
7	TMDS Data0+	8	TMDS Data0 Shield
9	TMDS Data0-	10	TMDS Clock+
11	TMDS Clock Shield	12	TMDS Clock-
13	CEC	14	Reserved (N.C. on device)
15	SCL	16	SDA
17	DDC/CEC Ground	18	+5V Power
19	Hot Plug Detect		

### 20-pin color display signal cable\*

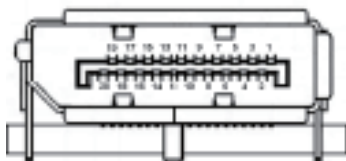

PIN No.	Description	PIN No.	Description
1	Lane0(p)	2	GND
3	Lane0(n)	4	Lane1(p)
5	GND	6	Lane1(n)
7	Lane2(p)	8	GND
9	Lane3(n)	10	Lane3(p)

11	GND	12	Lane3(n)
13	Config1	14	Config2
15	AUX_CH (n)	16	GND
17	AUX_CH (p)	18	Hot Plug Detect
19	DP Power_Return	20	DP Power

\* only for certain models

## 24-pin USB 3.1 Type C cable

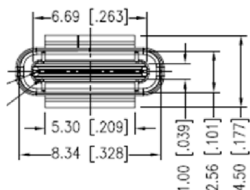

PIN No.	Signal Assignment	PIN No.	Signal Assignment
A1	GND	B12	GND
A2	SSTXp1	B11	SSTXp1
A3	SSTXn1	B10	SSTXn1
A4	VBUS	B9	VBUS
A5	CC1	B8	CC1
A6	Dp1	B7	Dp1
A7	Dn1	B6	Dn1
A8	SBU1	B5	SBU1
A9	VBUS	B4	VBUS
A10	SSTXn2	B3	SSTXn2
A11	SSTXp2	B2	SSTXp2
A12	GND	B1	GND

\* only for certain models

# Standard timing table

VESA MODE		
MODE	Resolution	
1	VESA	720 x 400 @ 70Hz
2	VGA	640 x 480 @ 60Hz
3	MAC	640 x 480 @ 67Hz
4	VGA	640 x 480 @ 72Hz
5	VGA	640 x 480 @ 75Hz
6	SVGA	800 x 600 @ 56Hz
7	SVGA	800 x 600 @ 60Hz
8	SVGA	800 x 600 @ 72Hz
9	SVGA	800 x 600 @ 75Hz
10	MAC	832 x 624 @ 75Hz
11	XGA	1024 x 768 @ 60Hz
12	XGA	1024 x 768 @ 70Hz
13	XGA	1024 x 768 @ 75Hz
14	XGA	1280 x1024 @ 75Hz
15	SXGA	1152 x 870 @75Hz
16	VESA	1152 x 864 @ 75Hz
17	VESA	1280 x 960 @ 60Hz
18	SXGA	1280 x 1024 @ 60Hz
19	VESA	1280 x 720 @ 60Hz
20	WXGA+	1440 x 900 @ 60Hz
21	WSXGA+	1680 x 1050 @ 60Hz
22	FHD	1920 x 1080 @ 60Hz
23	FHD	1920x1080 @ 75Hz
24	QHD	2560x1440 @ 60Hz
25	QHD	2560x1440 @ 75Hz

# Installation

1. Turn off your computer and unplug your computer's power cord.
2. Connect the signal cable to the DP (optional) and/or HDMI (optional) input socket of the monitor, and the DP (optional) and/or HDMI (optional) output socket of the graphics card on the computer. Then tighten the thumbscrews on the signal cable connector.
3. Connect the USB Cable(Optional)  
Connect the USB cable to port for fast charge.  
Connect the USB cable to port.
4. USB Type C Cable (Optional, USB Type-C input models only)  
Connect one end of the USB type C cable (optional) to your computer and connect the other end to your electric devices.
5. Insert the monitor power cable into the power port at the back of the monitor.
6. Plug the power cords of your computer and your monitor into a nearby electrical outlet.
7. Connecting HDMI/DP+USB-B to computer 1 and USB-C to computer 2 when Control up to 2 computers from a single set of keyboard and mouse connected to the monitor.

**Visit Acer Support website to download IR webcam driver:**

<https://www.acer.com/worldwide/support/>

Note:

1. Audio output is only for audio output model. Please check user manual for more instruction.
2. RJ45:support 10M/100M/1000Mbps
3. If your computer USB-C do not have DP-Alt, pls connect HDMI/DP+USB-B to computer 1 and HDMI/DP+USB-C to computer 2.

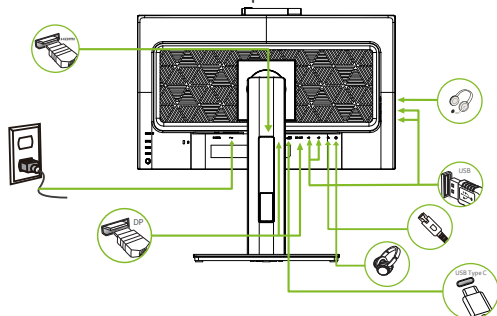

\*POWER CORD specifications refer to page15

\*For the installation of replaceable parts, please refer to the above installation instructions.

\*Users may go to the local service network to replace /purchase the qualified replaceable parts.

For local service centers and service contacts, please refer to <https://www.acer.com/ac/en/US/content/support>

\*IR webcam feature depends on model, sku and/or region.

# Daisy-chain function



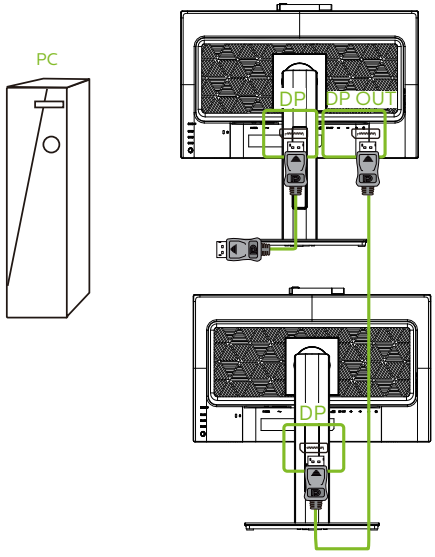

English

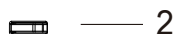

# User Controls



## External controls

1	Power button	Turns the monitor on/off. Blue indicates power on. Amber indicates standby, power saving and OSD locked.
2	Function key 	<ol style="list-style-type: none"> <li>Press to view Main page. Press again to enter hotkey1 function.</li> <li>When the Function Menu is active, press this key to view the basic information for your monitor and current input or reset the custom color settings to the factory defaults.</li> </ol>
3	Function key 	<ol style="list-style-type: none"> <li>Press to view Main page. Press again to enter hotkey2 function.</li> <li>When the Function Menu is active, press this button to select select scenario mode or game mode .</li> </ol>
4	Function key 	<ol style="list-style-type: none"> <li>Press to view Main page. Press again to enter Input select function.</li> <li>When the Function Menu is active, this button will quit the OSD.</li> </ol>
5	Function key 	<ol style="list-style-type: none"> <li>Press to view Main page. Press again to enter next function in the Function Menu.</li> <li>The single toggle button on the backside of the Display bezel operates like a joystick. To move the cursor, simply toggle the button in four directions. Press the button to select desired option. Bright gray indicates operable. Dark gray indicates inoperable.</li> </ol>

### ***KVM switch:***

The built-in KVM switch allows you to control up to 2 computers from a single set of keyboard and mouse connected to the monitor.

## Using the Shortcut Menu



**Note:** The following content is for general reference only. Actual product specifications may vary.

The OSD (onscreen display) can be used to adjust the settings of your LCD monitor. Press the MENU key to open the OSD. You can use the OSD to adjust the picture quality and general settings. For advanced settings, please refer to following page:

### Main page

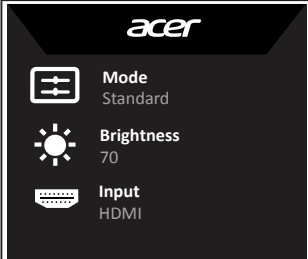
	<ol style="list-style-type: none"> <li>1. Menu OSD</li> <li>2. Hot Key1 (Modes, Volume, Brightness, Gamma, Contrast, Low Blue Light, Over Drive, USB Port Select, PIP/PBP)</li> <li>3. Hot Key2 (Modes, Volume, Brightness, Gamma, Contrast, Low Blue Light, Over Drive, USB Port Select, PIP/PBP)</li> <li>4. Input selection</li> </ol>
---	---

### Hot key1 (default: Modes)

To choose scenario mode (sRGB, Rec.709, HDR, User, Standard, ECO, Graphics, Movie)

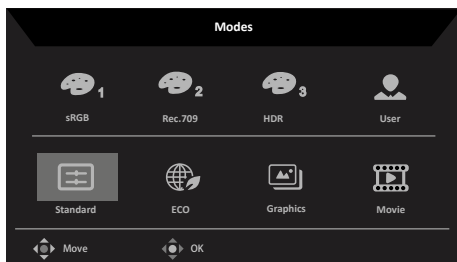

### Hot key2 (default: Brightness)

Open the Brightness control and select your preferred brightness setting. When you are done, press the joystick to quit current page and store.

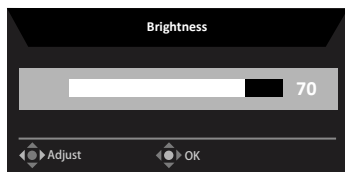

### Selecting the input

Open the Input control and select HDMI(2.0), DP, DP ALT or Auto Source. When you are done, press the joystick to exit current page and store.



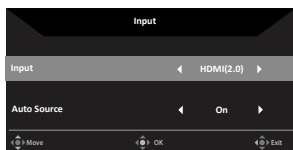

## The Function page

Open the Function page to adjust the functions, settings which you want using the arrows. When you are done, toggle the joystick to the left or right to go back one level or use **X-** to exit current page and store.

## Picture

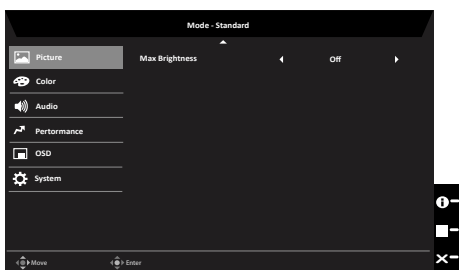
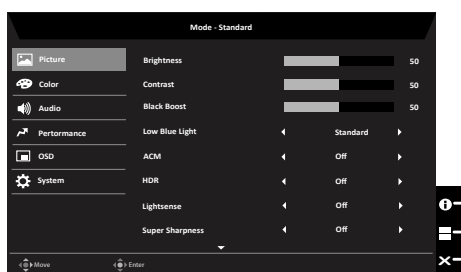

1. Press the MENU key to open the OSD.
2. Toggle the joystick to the up or down to select Picture from the OSD. Then toggle to the right to navigate to the element you wish to adjust and press the joystick to enter it.
3. Toggle to the left or right to adjust the sliding scales.
4. The Picture menu can be used to adjust the Brightness, Contrast, Black Boost, Low Blue Light, ACM, HDR, LightSense, Super Sharpness, Max Brightness.
5. Brightness: Adjust the brightness from 0 to 100.



**Note:** Adjusts the balance between light and dark shades.

6. Contrast: Adjust the contrast from 0 to 100.



**Note:** Sets the degree of difference between light and dark areas.

7. Black Boost: Adjust the black level from 0 to 10. Enhances shadows by increasing the brightness without changing lighter shades.
8. Low Blue Light: The display uses the low blue light panel. It complies with TÜV Rheinland Low Blue Light Hardware Solution certification under factory reset/default setting (Low Blue Light=Standard, Brightness: 80%, Contrast: 50%, CCT: Warm).
9. ACM: Turn ACM on or off.



**Note:** Set to "On", will be based on the current screen to dynamic contrast adjustment.

10. HDR: can control off and auto, the default is off, set to auto will automatically detect and deal with HDR signal.



**Note:** 1. When HDR = Auto, the Modes will also be automatically set to "HDR".

2. When HDR = Auto or HDR 10, some parameters :(ACM, Gamma, Contrast, Low Blue Light, Black Boost...) functions is gray out and disable, and if you change other adjustable parameters, the "Modes" will not jump to "User" Mode.

11. LightSense: LightSense can choose: (Off, Level 1, Level 2 and Level 3), Off is default, Level 3 brightness automatically adjust the maximum range, Level 2 brightness automatically adjust the range is moderate, Level 1 brightness automatically adjust the minimum range.
12. Super Sharpness: Turn the Super Sharpness On or Off. Super Sharpness technology can simulate high-resolution images by boosting the pixel density of the original source to make images sharper and clearer.
13. Max Brightness: The default is Off, select On to compensate for higher brightness.

## Color

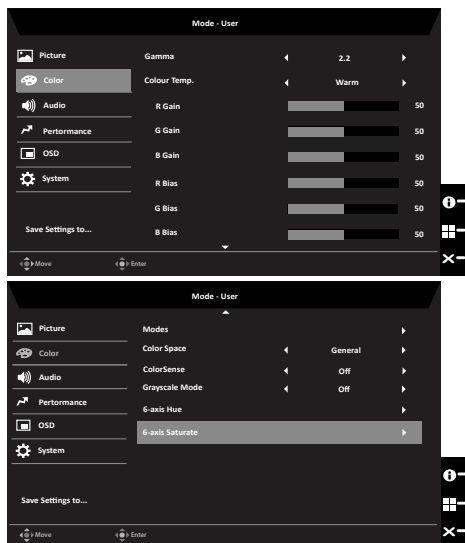

1. Press the MENU key to open the OSD.
2. Toggle the joystick to the up or down to select Color from the OSD. Then toggle to the right to navigate to the element you wish to adjust and press the joystick to enter it.
3. Toggle to the left or right to adjust the sliding scales.
4. Gamma mode allows you to adjust the luminance tone. The default value is 2.2 (standard value for Windows).
5. Color temperature: Default is warm. You can choose Cool, Normal, Warm, Low Blue light or User.
6. Modes: To choose scenario mode.
7. Color Space: You can choose sRGB, Rec.709, HDR, EBU, DCI, SMPTE-C and General.



**Note:** Color Space = HDR to correspond Modes is HDR, Other Color Space the Modes=Standard.

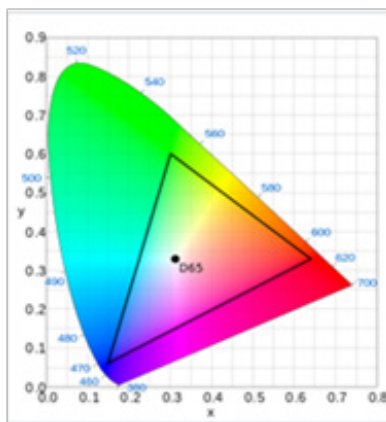
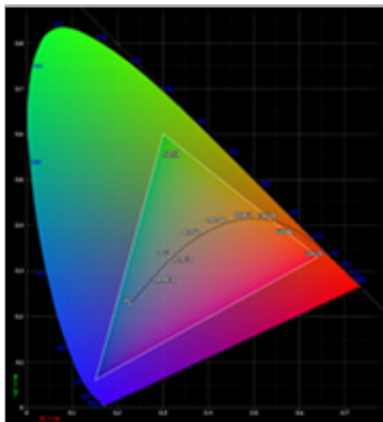

- CIE 1931 positive and negative error of 0.05, ("HDR" according to current Panel to fine-tune).
  - Color Space = HDR, the Modes = HDR, Picture page HDR = Auto.
  - Modes = (Action/Racing/Sports/User/Standard/ECO/Graphics) is selected; the color space is auto set to "General".
  - Color Space = (sRGB/Rec.709/HDR/EBU/DCI/SMPTE-C), If to adjust the parameter the Modes will not jump to User mode, but the Color Space = "General" except.
  - Color Space = (sRGB/Rec.709/HDR/EBU/DCI/SMPTE-C), 6-Axis Hue & Saturate is gray out and unavailable.
  - Color Space = (sRGB/Rec.709/HDR/EBU/DCI/SMPTE-C), Grayscale Mode is gray out and unavailable.
  - Color Space = (sRGB/Rec.709/HDR/EBU/DCI/SMPTE-C), (Light & Color) Sensor are gray out and unavailable.
  -
8. ColorSense: Automatically adjust color temperature smoothly.





---

**Note:**

- ColorSense is On, Factory Menu can check the CT (Color Temp) Value.
  - Mode = HDR, does not support the ColorSense.
  - Color Space = (sRGB/Rec.709/HDR/EBU/DCI/SMPTE-C), does not support the ColorSense.
  - ColorSense is on, the Modes is User, the (Contrast, Color Temp, Low Blue Light, 6 axis Hue, 6 axis Saturate, Grayscale Mode) functions are gray out and unavailable.
9. Grayscale Mode: To choose Grayscale mode.
10. 6-axis Hue: Adjust the red, green, blue, yellow, magenta and cyan hue.
11. 6-axis Saturate: Adjust the red, green, blue, yellow, magenta and cyan saturation.

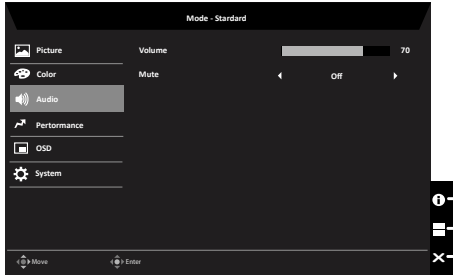
## Audio



1. Press the MENU key to open the OSD.
2. Toggle the joystick to the up or down to select Audio from the OSD. Then toggle to the right to navigate to the element you wish to adjust and press the joystick to enter it.
3. Toggle to the left or right to adjust the sliding scales.
4. Volume: Adjust the volume
5. Mute: To choose mute on/off .

## Performance

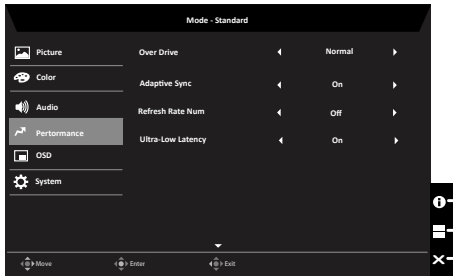

1. Press the MENU key to open the OSD.
2. Toggle the joystick to the up or down to select Performance from the OSD. Then toggle to the right to navigate to the element you wish to adjust and press the joystick to enter it.
3. Toggle to the left or right to adjust the sliding scales.
4. Over Drive: Select Off, Normal or Extreme.
5. AdaptiveSync: To control support AdaptiveSync or not, default is On.



**Note:** If AdaptiveSync is "ON", then the Over Drive selection is set to "Normal" automatically.

6. Refresh rate num: Display the panel's current refresh rate on the screen.



**Note:** If AdaptiveSync set "On" you can see the V Frequency to changes in the OSD.

- Ultra-Low Latency: Set to On to speed up the processing time of the display.



**Note:** AdaptiveSync is On, the Ultra-Low Latency automatic set to On and Ultra-low latency is not supported at resolutions below 800x600.

## OSD

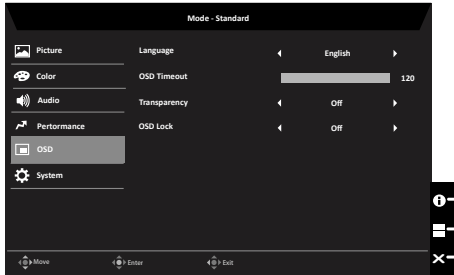

- Press the MENU key to open the OSD.
- Toggle the joystick to the up or down to select OSD from the OSD. Then toggle to the right to navigate to the element you wish to adjust and press the joystick to enter it.
- Toggle to the left or right to adjust the sliding scales.
- Language: Set the OSD menu language.
- OSD timeout: Adjust the delay before turning off the OSD menu.
- Transparency: Select the transparency when using gaming mode. The transparency can be 0% (OFF), 20%, 40%, 60%, or 80%.
- OSD Lock: To choose OSD lock on/off.



---

**Note:****OSD Locked:**

- Set the OSD Lock to "On" by the OSD option and press "Enter" to execute the All Key lock function.
- The "OSD Locked" message will be displayed in the middle of the screen.
- LED lights will be changed from blue light to orange light.
- Press any Key screen to prompt "OSD Locked" message.

**OSD Unlocked:**

- In normal display condition to press the "Navi Key" in the middle of more than 3 seconds to trigger "OSD Unlock".
- The "OSD Unlock" message will be displayed in the middle of the screen.
- LED lights will be restored to blue light.

# System

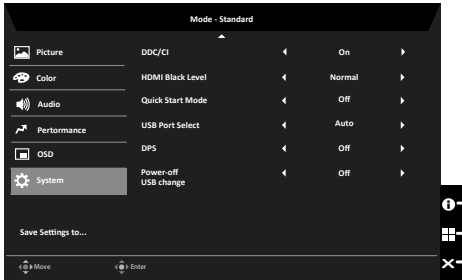
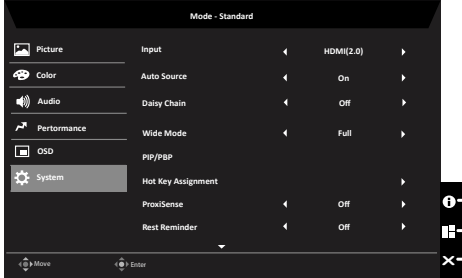

1. Press the MENU key to open the OSD.
2. Toggle the joystick to the up or down to select System from the OSD. Then toggle to the right to navigate to the element you wish to adjust and press the joystick to enter it.
3. Toggle to the left or right to adjust the sliding scales.
4. Input: Select the source from HDMI(2.0) ,DP or DP ALT.
5. Auto Source: The default is “On”, which can support auto search for signal source in order.



**Note:** Surround application must set Auto Source is “Off”.

6. Daisy Chain: Default is Off, can select daisy chain function Extend or Clone. Clone mode is not supported with AdaptiveSync.
7. Wide mode: You can select which screen aspect you are using. The options are Aspect, Full, 1:1 and 21:9.
8. PIP/PBP settings



**Note:**

1. PIP/PBP function does not support HDMI 1 and HDMI 2 simultaneously.
2. Under PIP & PBP mode, “Auto search” function is unavailable. The PIP/PBP signal source needs to be selected manually.

PIP/PBP & Input status			
	HDMI 1	HDMI 2	DP



HDMI 1	--	X	O
HDMI 2	X	--	O
DP	O	O	--
X: Does not support PIP/PBP function in this input combination			

9. Hotkey Assignment: Hot Key 1 and Hot Key 2 can't repeat the same function. Hot Key 1 default is (Modes), Hot Key 2 default is (Brightness). Because some functions limit the Hot Key to be gray out and unavailable. Hot Key can define of: (Modes, Brightness, Volume, Gamma, Contrast, Low Blue Light, Over Drive, USB Port Select, PIP/PBP).
10. DDC/CI: Allows the monitor settings to be set through the software on the PC.



**Note:** DDC/CI, short for Display Data Channel/Command Interface, which allows monitor controls to be sent via software.

11. ProxiSense: ProxiSense works on principle of transmission and reception of harmless "infrared" signals in order to detect user-presence.



**Note:**

- The ProxiSense is set to (Range 1 to Range 3), tolerance is (+/-) 20 cm and ACM is off.
- Three status (No signal, no cable connection and out of range) does not support ProxiSense.
- The ProxiSense controls the PWM to 50% (current OSD Brightness parameter) or into the power saving state, and then press any key to restore the PWM to the normal value.
- Power The detection range of the Sensor is in the middle, the upper and lower angles are ignored.

12. Rest Reminder: ProxiSense is set Range1~Range3 then Rest Reminder can be control (Off ~ 100Mins), Rest Reminder default is Off.



**Note:**

- ProxiSense must be set to Range 1 and Range 3 before the Rest Reminder can be opened for selection (Off /20 Mins /40 Mins /60 Mins /80 Mins /100 Mins ), The default setting is Off /not remind.
- Reminder message will display in the middle of the screen, press any key except the power button to hide the message, The Duration time of Reminder message depend on OSD Timeout function.
- When set to (20 Mins ~ 100 Mins), because the ProxiSense continues to detect people, it will continue to time. When the set time is reached, the Reminder Message will be displayed, will be displayed, as shown in the figure above.

13. HDMI Black level setting.

14. Quick start mode: Select Off or On. Turn on to speed up boot speed.

15. USB Port Select: Select the USB Port from (Auto/B-Type/C-Type), default is Auto.



**Note:**

- Auto switch according to the currently lit signal source. If the current display is HMDI/DP, it will auto switch to B-Type, and if the current display is DP ALT, it will auto switch to C-Type.

16. Power-off USB charge: Turn On or Off. DC off/Saving mode can to electrify for USB port. Off: DC off/Saving mode can't to electrify for USB port.



**Note:**

- Power-off USB charge is set to off by default. Therefore, the sleep mode cannot be resumed under the USB Type-C input. The user needs to change the Power-off USB to on.
- In the second method, when the following message appears after the MNT is turned on, please directly press "OK Change", and the MNT will automatically set the Power-off USB Charge function to On.

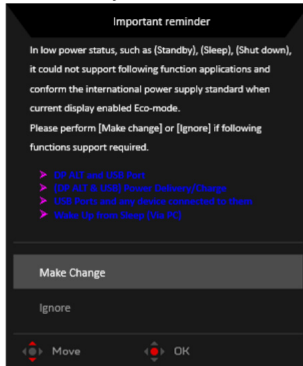

## Setting the KVM

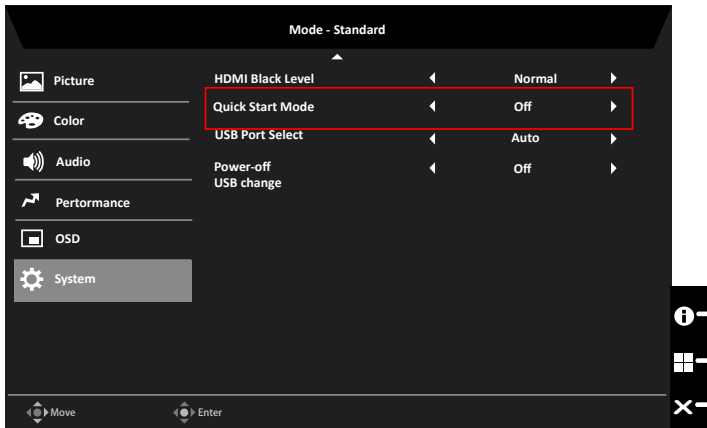

You can follow below instruction to set up KVM for your monitor:

- Connect Type-C/USB-B to your computer
- Select Type-C/USB-B of USB Port Select in the OSD
- Suggest setup:

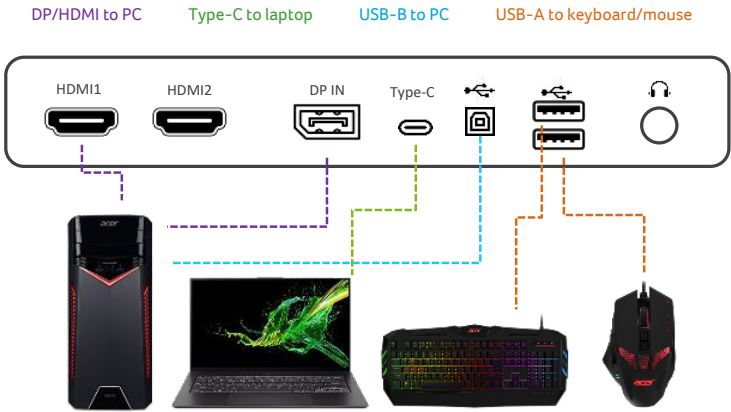

**Note:**

- When connecting two computers to the monitor, configure the USB settings from the OSD menu to share a single set of keyboard and mouse connected to the monitor between two computers.

## Save Setting to...(User mode only)

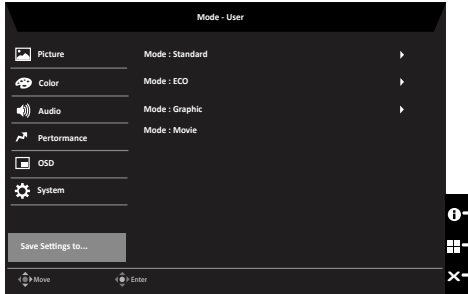

1. Press the MENU key to open the OSD.
2. Toggle the joystick to the up or down to select "Save Setting to..." from the OSD. Then toggle to the right to navigate to the element you wish to adjust and press the joystick to enter it.
3. Save Setting to some mode: There are four user-defined profiles available. When you have decided what settings suit you, save them and system will be able to recall the settings in the future when you turn on these mode.

### Regulatory Compliance

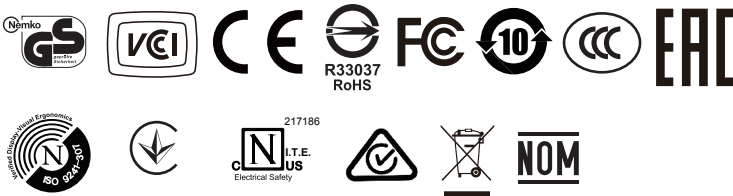

# Troubleshooting

Before sending your LCD monitor for servicing, please check the troubleshooting list below to see if you can self-diagnose the problem.

## DP/HDMI Mode (Optional)

Problem	LED status	Remedy
No picture visible	Blue	Using the OSD menu, adjust brightness and contrast to maximum or reset to their default setting.
	Off	Check the power switch.  Check if the AC power cord is properly connected to the monitor.
	Amber	Check if the video signal cable is properly back of monitor.  Computer system is switched on in sleep/standby mode.  If necessary, the LED status set Amber.

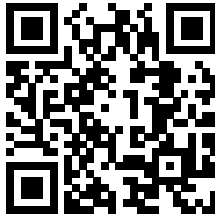

Product Information for EU Energy