

Steam Iron

User's manual

EN



SENCOR®

SSI 2027BL

SSI 2028YL

Prior to using this appliance, please read the user's manual thoroughly, even in cases, when one has already familiarised themselves with previous use of similar types of appliances. Only use the appliance in the manner described in this user's manual. Keep the manual for future use.

Save the original shipping transport box, packaging material, receipt and warranty card for the duration of the warranty. In the event of transportation, pack the appliance using the original packaging materials only.

CONTENTS

IMPORTANT SAFETY INSTRUCTIONS.....	3
DESCRIPTION OF THE STEAM IRON.....	5
USING THE STEAM IRON	6
TIPS FOR QUALITY IRONING	8
MAINTENANCE AND CLEANING	8
STORAGE.....	8
TECHNICAL SPECIFICATIONS	9
INSTRUCTIONS AND INFORMATION REGARDING THE DISPOSAL OF USED PACKAGING MATERIALS ..	9
DISPOSAL OF USED ELECTRICAL AND ELECTRONIC APPLIANCES	9

IMPORTANT SAFETY INSTRUCTIONS

- **This steam iron may be used by children 8 years of age and older and by persons with physical or mental impairments or by inexperienced persons if they are properly supervised or have been informed about how to use of the product in a safe manner and understand the potential dangers. Do not allow children to play with the iron. Cleaning and maintenance performed by the user must not be performed by unsupervised children. If it is connected to a power socket or if it is cooling down, keep the iron and its power cord out of reach of children younger than 8 years of age.**
- **Always disconnect the iron from the power socket before filling or emptying the water tank, before putting it away for a short time or after finishing using it.**
- **The iron must not be left without supervision if it is connected to an electrical power socket.**
- **The iron must be used and placed on a stable surface.**
- **When placing the iron on a stand, ensure that the surface on which the stand is located is stable.**
- **The iron must not be used if it shows visible signs of damage if it is leaking or if it has fallen on the floor.**

IMPORTANT SAFETY INSTRUCTIONS READ CAREFULLY AND STORE FOR FUTURE USE

- Before connecting the steam iron to a power socket check that the nominal voltage stated on the rating label matches the electrical voltage in the socket.
- Connect the steam iron only to a properly grounded socket. If necessary, an extension cord marked with a maximum electrical current capacity of 10 A may be used. A power cord with an insufficient capacity could overheat. Do not connect any other appliances to the extension cord. Position the extension cord so that it will not be stepped on or tripped over.
- This steam iron is designed for home use. Do not use it in industrial surroundings or outdoors!
- Do not use the iron for any other purposes than those intended.
- Do not place the iron on or near an electric or gas stove or other sources of heat.
- Before disconnecting the iron from the el. power socket, set the output steam regulator to the 'ironing without steam' position.
- If you have wet hands do not touch the iron if it is connected to an el. power socket.
- Never iron clothing on a body.
- Do not touch the hot ironing surfaces. Otherwise, this could cause burns.
- Always disconnect the iron from the el. power socket after use and allow the ironing surface to cool down.
- To avoid any injury by electrical shock, do not clean the iron under running water and do not submerge in water or any liquid.
- Do not use vinegar, limescale remover or other agents for preventing water scale deposits inside the water tank.
- Ensure that the power cord does not come into contact with water, moisture or a heated surface.
- Do not disconnect the iron from the power socket by pulling on the power cord. This could damage the power cord or the power socket. Disconnect the cord from the power socket by gently pulling out the plug of the power cord.
- If the power cord is damaged, have it replaced at a professional service centre. It is forbidden to use the iron if it has a damaged power cord or plug.
- To avoid the danger of injury by electrical shock, do not repair the iron yourself or make any adjustments to it. Have all repairs or adjustments performed at an authorised service centre. Tampering with the appliance during the warranty period may void the warranty.

Steam Iron

SSI 2027BL / SSI 2028YL

EN

DESCRIPTION OF THE STEAM IRON

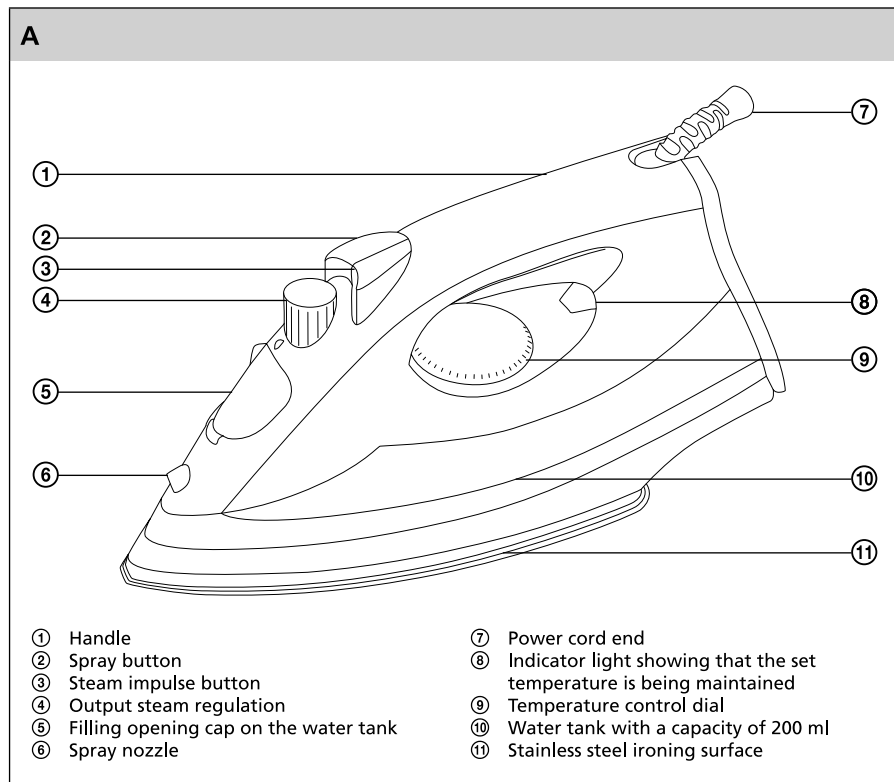





USING THE STEAM IRON

- Wipe the ironing surface with a lightly damp cloth before first use and then wipe dry.

PREPARATION BEFORE IRONING

- Sort the laundry according to international symbols shown on the labels or according to the fabric types.

SYMBOL	FABRIC TYPE	SETTING THE TEMPERATURE CONTROL DIAL
	Synthetics (nylon, polyamid, polyester, etc.)	• Low temperature
	Silk – wool	•• Medium temperature
	Cotton	••• High temperature
	Linen	MAX Maximum temperature
	Fabric, that should not be ironed.	

IRONING WITH STEAM

1. Filling the water tank

- Check that the iron is disconnected from the power socket.
- Set the output steam regulator A④ to the position marked by the symbol .
- Flip open the filling opening cap on the water tank A⑤.
- Tilt the iron backwards and fill tank A⑩ with water. Ensure that the water level does not exceed the maximum water level mark.
- Close shut the filling opening cap on the water tank A⑤. Place the iron on a stable, even surface in a vertical position.



Note:

To fill the tank A⑩ you may use water that has a medium-hard water hardness level (up to 14 °dH / 2.5 mmol/l).

If water in your area is particularly hard, we recommend that you use 1 part of distilled water and 1 part of tap water.

2. Setting the temperature control dial

- Ensure that the iron is located in a vertical position on an even stable surface.
- Connect the power cord to an el. power socket.
- Set temperature control dial A⑨ based on the fabric type you wish to iron. A lit indicator light A⑧ signals that the ironing surface is heating up. As soon as the ironing surface heats up to the set temperature, the indicator light A⑧ will turn off.



Note:



During first use a weak cracking sound caused by the expanding plastic may be heard. This is an entirely normal event, which will disappear in a short time.

While ironing the indicator light A⑧ will intermittently turn on and off. This indicates that the set temperature is being maintained.

First iron the laundry that requires the lowest temperature. This will save you time because the iron heats up faster than it cools down.

If you are ironing at a high temperature and then set a lower temperature, wait until the iron cools down.

3. Steam

- Only use the steam function when the temperature control dial A⑨ is set to a temperature of •• to MAX. At a temperature of •• use the regulator A④ to set a weaker steam output . At a temperature of ••• to MAX use the regulator A④ to set a stronger steam output .



Note:

If the set temperature is too low, water may drip from the ironing surface.

The iron continuously emits steam only if you hold it in a horizontal position. Stop the release of steam by standing the iron upright in a vertical position or by turning the output steam regulator A④ to the position marked by symbol .

FUNCTION OF THE STEAM IMPULSE

- Press the steam impulse button A③ to generate a strong flow of steam which can even out even very crumpled up textiles.
- Only use the steam impulse function when the temperature control dial A⑨ is set to a temperature of ••• to MAX. If indicator light A⑧ turns on, wait until it turns off and only then press the steam impulse button A③. Wait several seconds before pressing the button again.
- The heat impulse function A③ can be used when ironing textiles (e.g. curtains, hanging clothes, etc.) in the vertical position.

SPRAYING FUNCTION

- The spraying function can be used when the temperature control dial A⑨ is set to any temperature. Ensure that there is water in the tank A⑩ and to dampen the textile press the spray button A②.



Note:

Do not use the spraying function on silk and synthetics.

DRY IRONING

- If you want to iron without steam, follow the instructions in chapter Steam ironing, point 2. Setting the temperature control dial.
- Set regulator A④ to the position marked by the symbol .



Note:

If you wish to use the spraying function for dry ironing it is necessary to fill the water tank. To fill the water tank follow the instructions in chapter Steam ironing, point 1. Filling the water tank.

TIPS FOR QUALITY IRONING



- Do not fill the washing machine drum with too much laundry, otherwise it will be overly crumpled up. You can also avoid overly crumpled laundry by setting a lower spin drying speed.
- If you are ironing fabrics from blended materials (e.g. 40 % wool and 60 % synthetic material), set the temperature control dial according to the material which is ironed at a lower temperature.
- If you do not know the composition of the fabric, identify the suitable temperature control dial setting by ironing a piece of the fabric from the underside. Start by setting the temperature control dial at a low temperature and gradually increase it until the ideal temperature is achieved.
- Never iron over places that have sweat marks or other stains. The high temperature fixes the stain making it difficult to remove.
- To avoid silk, wool and synthetic fabrics from being shiny after ironing, iron them from the underside.
- Some materials are easier to iron when they are lightly damp (e.g. silk).
- Dampen fine fabrics with the spray before ironing them or iron them under a lightly damp wiping cloth.

MAINTENANCE AND CLEANING

Cleaning the exterior parts of the iron

- Before cleaning the iron, disconnect it from the power socket. Allow the ironing surface to cool down and empty the water tank.
- Wipe the ironing surface and the housing of the iron with a lightly damp wiping cloth. Then wipe all parts until dry.
- Do not use metal items or abrasive cleaning products for cleaning.

Removal of limescale deposits

- For the removal of limescale deposits from the steam chamber the iron is equipped with a Self-Clean function. Use the Self-Clean function regularly at least once per month.
- Fill the tank A⑩ with water up to approximately half its capacity. Check that the output steam regulator A④ is set to position . Connect the iron to a power socket. Set the temperature control dial A⑨ to maximum and wait until the control light A⑧ turns off. Disconnect the iron from the el. power socket and hold it in a horizontal position above the sink. Turn the output steam regulator A④ to the position marked by the symbol of an iron underlined by dots. Steam will start to be emitted from the ironing surface and water will drip out. Slightly move the iron from side to side, until its contents are emptied completely. Together with the dripping water, limescale deposits will be removed from the steam chamber. Turn the output steam regulator A④ back to position . Allow the iron to cool down and then wipe the ironing surface dry using a clean cloth.

STORAGE

- Unplug the iron from the el. power socket and let it cool completely. Empty the water tank and store the iron in a vertical position in a safe place.

Steam Iron

SSI 2027BL / SSI 2028YL

EN

TECHNICAL SPECIFICATIONS

Nominal voltage range220–240 V
Nominal frequency.....50/60 Hz
Rated power input..... 1450–1750 W

We reserve the right to change text and technical specifications.

INSTRUCTIONS AND INFORMATION REGARDING THE DISPOSAL OF USED PACKAGING MATERIALS

Dispose of packaging material at a public waste disposal site.

DISPOSAL OF USED ELECTRICAL AND ELECTRONIC APPLIANCES



The meaning of the symbol on the product, its accessory or packaging indicates that this product shall not be treated as household waste. Please, dispose of this product at your applicable collection point for the recycling of electrical & electronic equipment waste. Alternatively in some states of the European Union or other European states you may return your products to your local retailer when buying an equivalent new product. The correct disposal of this product will help save valuable natural resources and help in preventing the potential negative impact on the environment and human health, which could be caused as a result of improper liquidation of waste. Please ask your local authorities or the nearest waste collection centre for further details. The improper disposal of this type of waste may fall subject to national regulations for fines.

For business entities in the European Union

If you wish to dispose of an electrical or electronic device, request the necessary information from your seller or supplier.

Disposal in other countries outside the European Union

If you wish to dispose of this product, request the necessary information about the correct disposal method from local government departments or from your seller.



This product meets all the basic EU regulation requirements that relate to it.

Steam Iron

SSI 2027BL / SSI 2028YL