

EPSON

WF-M5399 Series User's Guide



Printing

Maintaining the Printer

Solving Problems

Contents

Guide to This Manual

Introduction to the Manuals.	7
Important Safety Instructions (paper manual).	7
Start Here (paper manual).	7
User's Guide (digital manual).	7
Information on the Latest Manuals.	7
Searching for Information.	7
Printing Only the Pages You Need.	8
About This Manual.	8
Marks and Symbols.	8
Notes on Screenshots and Illustrations.	9
Operating System References.	9
Trademarks.	10
Copyright.	11

Important Instructions

Safety Instructions.	14
Printer Advisories and Warnings.	15
Advisories and Warnings for Setting Up the Printer.	15
Advisories and Warnings for Using the Printer.	15
Advisories and Warnings for Using the LCD Screen.	16
Advisories and Warnings for Connecting to the Internet.	16
Advisories and Warnings for Using the Printer with a Wireless Connection.	16
Notes on the Administrator Password.	16
Advisories and Warnings for Transporting or Storing the Printer.	18
Protecting Your Personal Information.	18

Part Names and Functions

Front.	20
Inside.	22
Rear.	23

Guide to the Control Panel

Control Panel.	25
Home Screen Configuration.	26
Guide to the Network Icon.	27
Menu Screen Configuration.	28
Entering Characters.	28

Preparing the Printer and Making Initial Settings

Summary of Preparing the printer and Making Initial Settings.	31
Preparing the Printer.	31
Protecting the Printer from Unauthorized Setting Changes.	31
Configuring a Network Connection.	31
Summary of the Necessary Preparations for Each Feature.	32
Making Printer Settings.	32
Installing the Optional Paper Cassette Units.	33
Mounting an Authentication Device.	38
Connecting the Authentication Device.	38
Confirming the Connection Status of the Authentication Device.	38
Confirming the Authentication Card is Recognized.	39
Troubleshooting the Authentication Device.	39
Creating a Network Connection and Making Settings.	39
Changing the Administrator Password.	40
Protecting Settings Using Panel Lock.	41
Connecting the Printer to the Network.	42
Troubleshooting Network Connections.	48
Preparing and Setting Up the Printer According to Use.	57
Setting Available Optional Items.	57
Preparing to Send an E-mail.	59
Initial Settings for Printing.	62
Using the Print Functions.	62
Setting the Paper Source.	67
Setting the Interface.	67
Setting Errors.	68
Setting Universal Print.	69
Setting Up Universal Print (Microsoft).	70
Setting Up AirPrint.	71
Problems when Making Settings.	72
Hints to Solving Problems.	72
Cannot Access Web Config.	72

Loading Paper

Paper Handling Precautions.	75
Paper Size and Type Settings.	75
List of Paper Type.	76

Loading Paper.	77
Loading Various Paper.	77
Loading Pre-punched Paper.	77
Loading Long Papers.	78

Printing

Printing Documents.	80
Printing from a Computer - Windows.	80
Printing a Document Using the PostScript Printer Driver (Windows).	102
Printing from a Computer - Mac OS.	106
Printing from the PostScript Printer Driver on Mac OS.	113
Printing Documents from Smart Devices.	117
Printing on Envelopes.	119
Printing on Envelopes from a Computer (Windows).	119
Printing on Envelopes from a Computer (Mac OS).	119
Printing Web Pages.	119
Printing Web Pages from Smart Devices.	119
Printing Using a Cloud Service.	120

Maintaining the Printer

Checking the Status of Consumables.	122
Improving Print Quality.	123
Adjusting the Print Quality.	123
Checking and Cleaning the Print Head.	124
Preventing nozzle clogging.	125
Aligning the Print Head.	125
Cleaning the Paper Path for Ink Smears.	126
Cleaning the Translucent Film.	126
Cleaning the Printer.	128

In These Situations

When the Software Disk is not Available.	131
When Replacing a Computer.	131
Installing or Uninstalling Applications Separately.	131
Installing the Applications Separately.	131
Installing a PostScript Printer Driver.	134
Adding a Genuine Epson Printer (for Mac OS Only).	135
Uninstalling Applications.	135
Making Settings for Connecting to the Computer.	137
Checking the Printer's Network Connection Status (Network Connection Report).	137

Connecting a Smart Device and Printer Directly (Wi-Fi Direct).	138
About Wi-Fi Direct.	138
Connecting to Devices using Wi-Fi Direct.	138
Disconnecting Wi-Fi Direct (Simple AP) Connection.	140
Changing the Wi-Fi Direct (Simple AP) Settings Such as the SSID.	140
Changing the Connection from Wi-Fi to USB.	141
Transporting and Storing the Printer.	142

Solving Problems

Problem Solving.	147
Check the printer's error status..	147
Check the printer connection..	147
Check the printer settings..	148
Cannot Print.	149
The Application or Printer Driver do not Work Properly.	149
The Printer Cannot Connect by USB.	152
Paper Does Not Feed or Eject Correctly.	153
Print Quality is Poor.	154
Banding Appears in Printouts.	154
Black or Gray Banding Appears at Intervals of Approximately 3.3 cm.	155
Vertical Banding or Misalignment.	155
Printout Comes Out as a Blank Sheet.	156
Paper Is Smearred or Scuffed.	157
The Position, Size, or Margins of the Printout Are Incorrect.	158
Printed Characters Are Incorrect or Garbled.	159
The Printed Image Is Inverted.	159
Mosaic-Like Patterns in the Prints.	160
Printer Does Not Print Correctly While Using PostScript Printer Driver.	160
Print Quality Is Poor While Using PostScript Printer Driver.	160
A Message is Displayed on the LCD Screen.	160
Paper Gets Jammed.	162
Preventing Paper Jams.	162
It is Time to Replace Ink Supply Units.	163
Ink Supply Unit Handling Precautions.	163
Replacing Ink Supply Units.	164
It is Time to Replace the Maintenance Box.	164
Maintenance Box Handling Precautions.	164
Replacing a Maintenance Box.	165
It is Time to Replace the Pickup Rollers.	165
Replacing Pickup Rollers for the Paper Cassette Unit.	165

Replacing Pickup Rollers for the Optional Paper Cassette Units.	166
Cannot Operate the Printer as Expected.	166
The Printer Does Not Turn On or Off.	166
Operations are Slow.	167
LCD Screen Gets Dark.	168
Operation Sounds Are Loud.	168
The Date and Time Are Incorrect.	169
The Root Certificate Needs to be Updated.	169
Cannot Perform Manual 2-sided Printing (Windows).	169
The Print Settings Menu is Not Displayed (Mac OS).	169
Forgot Your Password.	170
Cannot Solve Problem.	170
Cannot Solve Printing Problems.	170

Product Information

Paper Information.	173
Available Paper and Capacities.	173
Consumable Products Information.	176
Ink Supply Unit Codes.	176
Maintenance Box Code.	177
Pickup Rollers Code.	177
Information on Optional Items.	178
Optional Paper Cassette Unit Code.	178
Software Information.	178
Application for Printing from a Computer (Windows Printer Driver).	178
Application for Printing from a Computer (Mac OS Printer Driver).	179
Application that can print PostScript Fonts (Windows PostScript Printer Driver).	180
Application that can print PostScript Fonts (Mac OS PostScript Printer Driver).	181
Application that can print PCL Language (PCL Printer Driver).	182
Application for Configuring Printer Operations (Web Config).	182
Application for Updating Software and Firmware (Epson Software Updater).	183
Software for Managing Devices on the Network (Epson Device Admin).	184
Epson Authentication System (Epson Print Admin).	184
Settings Menu List.	184
General Settings.	185
Print Counter.	196
Supply Status.	196
Maintenance.	196

Language 	197
Printer Status/Print.	197
Authentication Device Status.	198
Epson Open Platform Information.	198
Product Specifications.	198
Printer Specifications.	198
Using Port for the Printer.	199
Interface Specifications.	200
Network Specifications.	200
PostScript Level 3 Compatibility.	203
Supported Third Party Services.	203
Dimensions.	204
Electrical Specifications.	204
Environmental Specifications.	205
Installation Location and Space.	205
System Requirements.	207
Font Specifications.	207
Available Fonts for PostScript.	207
Available Fonts for PCL (URW).	208
List of Symbol Sets.	210
Regulatory Information.	213
Standards and Approvals.	213
German Blue Angel.	214
Restrictions on Copying.	214

Administrator Information

Managing the Printer.	217
Checking Information for a Remote Printer.	217
Setting the Control Panel.	217
Controlling the Panel Operation.	218
Managing the Network Connection.	218
Configuring Email Notifications When Events Occur.	223
Power Saving Settings During Inactivity.	225
Backing Up and Importing Printer Settings.	226
Updating the Firmware.	228
Synchronizing the Date and Time with Time Server.	230
Clearing Internal Memory Data.	230
Configuring Periodic Cleaning.	231
Controlling the Power Supply to the Printer Using Web Config.	231
Restore Default Settings.	232
Product Security Settings.	232
Restricting Available Features.	232
Restricting USB Connections.	235
Encrypting the Password.	236
Using the Audit Log Feature.	236
Restricting File Operations from PDL.	237

Changing the Administrator Password Using Web Config.	238
Enabling Program Verification on Start Up.	238
Network Security Settings.	239
Controlling Using Protocols.	239
Using a Digital Certificate.	244
SSL/TLS Communication with the Printer.	250
Encrypted Communication Using IPsec/IP Filtering.	252
Connecting the Printer to an IEEE802.1X Network.	263
Network Security Issues.	266
Using Epson Open Platform.	272
Epson Open Platform Overview.	272
Configuring Epson Open Platform.	273
Validating of Epson Open Platform.	273
Epson Remote Services Information.	274

Where to Get Help

Technical Support Web Site.	276
Contacting Epson Support.	276
Before Contacting Epson.	276
Help for Users in Europe.	276
Help for Users in Taiwan.	276
Help for Users in Australia.	277
Help for Users in New Zealand.	277
Help for Users in Singapore.	278
Help for Users in Thailand.	278
Help for Users in Vietnam.	279
Help for Users in Indonesia.	279
Help for Users in Hong Kong.	279
Help for Users in Malaysia.	280
Help for Users in India.	280
Help for Users in the Philippines.	281

Guide to This Manual

Introduction to the Manuals.	7
Searching for Information.	7
Printing Only the Pages You Need.	8
About This Manual.	8
Trademarks.	10
Copyright.	11

Introduction to the Manuals

The following manuals are supplied with your Epson printer. As well as the manuals, check the various types of help information available from the printer itself or from the Epson software applications.

Important Safety Instructions (paper manual)

Provides you with instructions to ensure the safe use of this printer.

Start Here (paper manual)

Provides you with information on setting up the printer and installing the software.

User's Guide (digital manual)

This manual. Available as a PDF and Web manual. Provides detailed information and instructions on using the printer and solving problems.

Information on the Latest Manuals

❑ Paper manual

Visit the Epson Europe support website at <http://www.epson.eu/support>, or the Epson worldwide support website at <http://support.epson.net/>.

❑ Digital manual

Visit the following website, enter the product name, and then go to **Support**.

<https://epson.sn>

Searching for Information

The PDF manual allows you to search for information you are looking for by keyword, or jump directly to specific sections using the bookmarks. This section explains how to use a PDF manual that has been opened in Adobe Acrobat Reader DC on your computer.

Searching by keyword

Click **Edit > Advanced Search**. Enter the keyword (text) for information you want to find in the search window, and then click **Search**. Hits are displayed as a list. Click one of the displayed hits to jump to that page.

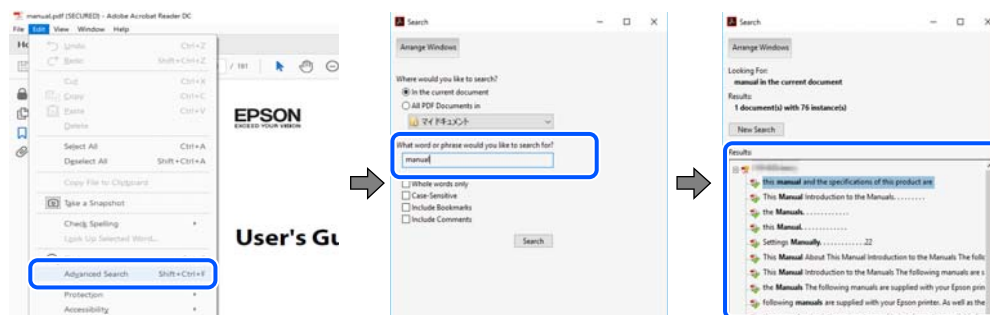

Jumping directly from bookmarks

Click a title to jump to that page. Click + or > to view the lower level titles in that section. To return to the previous page, perform the following operation on your keyboard.

- ❑ Windows: Hold down **Alt**, and then press ←.
- ❑ Mac OS: Hold down the command key, and then press ←.

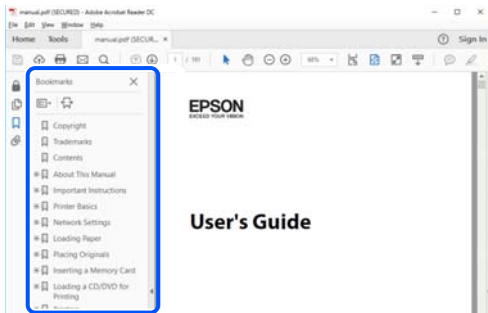

Printing Only the Pages You Need

You can extract and print only the pages you need. Click **Print** in the **File** menu, and then specify the pages you want to print in **Pages in Pages to Print**.

- ❑ To specify a series of pages, enter a hyphen between the start page and the end page.
Example: 20-25
- ❑ To specify pages that are not in series, divide the pages with commas.
Example: 5, 10, 15

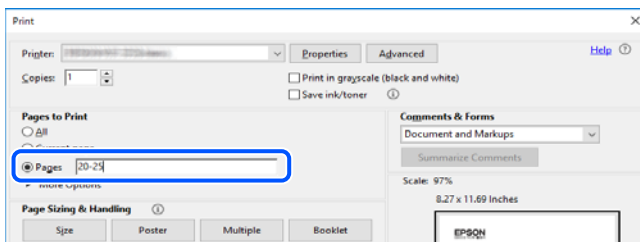

About This Manual

This section explains the meaning of marks and symbols, notes on descriptions, and operating system reference information used in this manual.

Marks and Symbols



Caution:

Instructions that must be followed carefully to avoid bodily injury.



Important:

Instructions that must be observed to avoid damage to your equipment.

Note:

Provides complementary and reference information.

Related Information

➔ Links to related sections.

 Provides Web Movie Manuals of the operating instructions. See the related information link.

 Control panel menu items that are restricted when the administrator lock is enabled.

Notes on Screenshots and Illustrations

- Screenshots of the printer driver are from Windows 10 or macOS High Sierra (10.13). The content displayed on the screens varies depending on the model and situation.
- Illustrations used in this manual are examples only. Although there may be slight differences depending on the model, the method of operation is the same.
- Some of the menu items on the LCD screen vary depending on the model and settings.
- You can read the QR code using dedicated app.

Operating System References

Windows

In this manual, terms such as "Windows 11", "Windows 10", "Windows 8.1", "Windows 8", "Windows 7", "Windows Vista", "Windows XP", "Windows Server 2022", "Windows Server 2019", "Windows Server 2016", "Windows Server 2012 R2", "Windows Server 2012", "Windows Server 2008 R2", "Windows Server 2008", "Windows Server 2003 R2", and "Windows Server 2003" refer to the following operating systems. Additionally, "Windows" is used to refer to all versions.

- Microsoft® Windows® 11 operating system
- Microsoft® Windows® 10 operating system
- Microsoft® Windows® 8.1 operating system
- Microsoft® Windows® 8 operating system
- Microsoft® Windows® 7 operating system
- Microsoft® Windows Vista® operating system
- Microsoft® Windows® XP operating system
- Microsoft® Windows® XP Professional x64 Edition operating system
- Microsoft® Windows Server® 2022 operating system
- Microsoft® Windows Server® 2019 operating system
- Microsoft® Windows Server® 2016 operating system
- Microsoft® Windows Server® 2012 R2 operating system
- Microsoft® Windows Server® 2012 operating system
- Microsoft® Windows Server® 2008 R2 operating system

- ❑ Microsoft® Windows Server® 2008 operating system
- ❑ Microsoft® Windows Server® 2003 R2 operating system
- ❑ Microsoft® Windows Server® 2003 operating system

Mac OS

In this manual, "Mac OS" is used to refer to Mac OS X 10.9.5 or later as well as macOS 11 or later.

Trademarks

- ❑ Microsoft®, Windows®, Windows Server®, and Windows Vista® are registered trademarks of Microsoft Corporation.
- ❑ Apple, Mac, macOS, OS X, Bonjour, ColorSync, Safari, AirPrint, iPad, iPhone, iPod touch, TrueType, and iBeacon are trademarks of Apple Inc., registered in the U.S. and other countries.
- ❑ Use of the Works with Apple badge means that an accessory has been designed to work specifically with the technology identified in the badge and has been certified by the developer to meet Apple performance standards.
- ❑ Chrome, Chrome OS, Google Play and Android are trademarks of Google LLC.
- ❑ Albertus, Arial, Coronet, Gill Sans, Joanna and Times New Roman are trademarks of The Monotype Corporation registered in the United States Patent and Trademark Office and may be registered in certain jurisdictions.
- ❑ ITC Avant Garde Gothic, ITC Bookman, Lubalin Graph, Mona Lisa, ITC Symbol, Zapf Chancery and Zapf Dingbats are trademarks of International Typeface Corporation registered in the U.S. Patent and Trademark Office and may be registered in certain other jurisdictions.
- ❑ Clarendon, Eurostile and New Century Schoolbook are trademarks of Linotype GmbH registered in the U.S. Patent and Trademark Office and may be registered in certain other jurisdictions.
- ❑ Wingdings is a registered trademark of Microsoft Corporation in the United States and other countries.
- ❑ CG Omega, CG Times, Garamond Antiqua, Garamond Halbfett, Garamond Kursiv, Garamond Halbfett Kursiv are trademarks of Monotype Imaging, Inc. and may be registered in certain jurisdictions.
- ❑ Antique Olive is a trademark of M. Olive.
- ❑ Marigold and Oxford are trademarks of AlphaOmega Typography.
- ❑ Helvetica, Optima, Palatino, Times and Univers are trademarks of Linotype Corp. registered in the U.S. Patent and Trademark Office and may be registered in certain other jurisdictions in the name of Linotype Corp. or its licensee Linotype GmbH.
- ❑ ITC Avant Garde Gothic, Bookman, Zapf Chancery and Zapf Dingbats are trademarks of International Typeface Corporation registered in the United States Patent and Trademark Office and may be registered in certain jurisdictions.
- ❑ PCL is the registered trademark of Hewlett-Packard Company.
- ❑ Adobe, Acrobat, Photoshop, PostScript®3™, and Reader are either registered trademarks or trademarks of Adobe in the United States and/or other countries.

Arcfour

This code illustrates a sample implementation of the Arcfour algorithm.

Copyright © April 29, 1997 Kalle Kaukonen. All Rights Reserved.

Redistribution and use in source and binary forms, with or without modification, are permitted provided that this copyright notice and disclaimer are retained.

THIS SOFTWARE IS PROVIDED BY KALLE KAUKONEN AND CONTRIBUTORS "AS IS" AND ANY EXPRESS OR IMPLIED WARRANTIES, INCLUDING, BUT NOT LIMITED TO, THE IMPLIED WARRANTIES OF MERCHANTABILITY AND FITNESS FOR A PARTICULAR PURPOSE ARE DISCLAIMED. IN NO EVENT SHALL KALLE KAUKONEN OR CONTRIBUTORS BE LIABLE FOR ANY DIRECT, INDIRECT, INCIDENTAL, SPECIAL, EXEMPLARY, OR CONSEQUENTIAL DAMAGES (INCLUDING, BUT NOT LIMITED TO, PROCUREMENT OF SUBSTITUTE GOODS OR SERVICES; LOSS OF USE, DATA, OR PROFITS; OR BUSINESS INTERRUPTION) HOWEVER CAUSED AND ON ANY THEORY OF LIABILITY, WHETHER IN CONTRACT, STRICT LIABILITY, OR TORT (INCLUDING NEGLIGENCE OR OTHERWISE) ARISING IN ANY WAY OUT OF THE USE OF THIS SOFTWARE, EVEN IF ADVISED OF THE POSSIBILITY OF SUCH DAMAGE.

QR Code is a registered trademark of DENSO WAVE INCORPORATED in Japan and other countries.

Firefox is a trademark of the Mozilla Foundation in the U.S. and other countries.

Mopria® and the Mopria® Logo are registered and/or unregistered trademarks and service marks of Mopria Alliance, Inc. in the United States and other countries. Unauthorized use is strictly prohibited.

microSDHC Logo is a trademark of SD-3C, LLC.

Note: microSDHC is built into the product and cannot be removed.



General Notice: Other product names used herein are for identification purposes only and may be trademarks of their respective owners. Epson disclaims any and all rights in those marks.

Copyright

No part of this publication may be reproduced, stored in a retrieval system, or transmitted in any form or by any means, electronic, mechanical, photocopying, recording, or otherwise, without the prior written permission of Seiko Epson Corporation. No patent liability is assumed with respect to the use of the information contained herein. Neither is any liability assumed for damages resulting from the use of the information herein. The information contained herein is designed only for use with this Epson product. Epson is not responsible for any use of this information as applied to other products.

Neither Seiko Epson Corporation nor its affiliates shall be liable to the purchaser of this product or third parties for damages, losses, costs, or expenses incurred by the purchaser or third parties as a result of accident, misuse, or abuse of this product or unauthorized modifications, repairs, or alterations to this product, or (excluding the U.S.) failure to strictly comply with Seiko Epson Corporation's operating and maintenance instructions.

Seiko Epson Corporation and its affiliates shall not be liable for any damages or problems arising from the use of any options or any consumable products other than those designated as Original Epson Products or Epson Approved Products by Seiko Epson Corporation.

Seiko Epson Corporation shall not be held liable for any damage resulting from electromagnetic interference that occurs from the use of any interface cables other than those designated as Epson Approved Products by Seiko Epson Corporation.

© 2023 Seiko Epson Corporation

The contents of this manual and the specifications of this product are subject to change without notice.

Important Instructions

Safety Instructions.	14
Printer Advisories and Warnings.	15
Protecting Your Personal Information.	18

Safety Instructions

Read and follow these instructions to ensure safe use of this printer. Make sure you keep this manual for future reference. Also, be sure to follow all warnings and instructions marked on the printer.

- Some of the symbols used on your printer are to ensure safety and proper use of the printer. Visit the following Web site to learn the meaning of the symbols.
<http://support.epson.net/symbols/>
- Use only the power cord supplied with the printer and do not use the cord with any other equipment. Use of other cords with this printer or the use of the supplied power cord with other equipment may result in fire or electric shock.
- Be sure your AC power cord meets the relevant local safety standard.
- Never disassemble, modify, or attempt to repair the power cord, plug, printer unit, or options by yourself, except as specifically explained in the printer's manuals.
- Unplug the printer and refer servicing to qualified service personnel under the following conditions:
The power cord or plug is damaged; liquid has entered the printer; the printer has been dropped or the casing damaged; the printer does not operate normally or exhibits a distinct change in performance. Do not adjust controls that are not covered by the operating instructions.
- Place the printer near a wall outlet where the plug can be easily unplugged.
- Do not place or store the printer outdoors, near excessive dirt or dust, water, heat sources, or in locations subject to shocks, vibrations, high temperature or humidity.
- Take care not to spill liquid on the printer and not to handle the printer with wet hands.
- Keep the printer at least 22 cm away from cardiac pacemakers. Radio waves from this printer may adversely affect the operation of cardiac pacemakers.
- If the LCD screen is damaged, contact your dealer. If the liquid crystal solution gets on your hands, wash them thoroughly with soap and water. If the liquid crystal solution gets into your eyes, flush them immediately with water. If discomfort or vision problems remain after a thorough flushing, see a doctor immediately.
- The printer is heavy and should not be lifted or carried by less than two people. If any paper cassettes other than Paper Cassette 1 are installed, uninstall them before lifting the printer. When lifting the printer, two or more people should assume the correct positions as shown below.

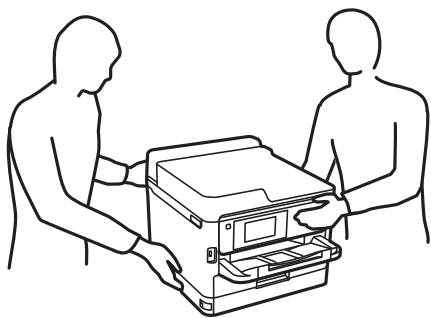

- Be careful when you handle used ink supply units, as there may be some ink around the ink supply port.
 - If ink gets on your skin, wash the area thoroughly with soap and water.
 - If ink gets into your eyes, flush them immediately with water. If discomfort or vision problems continue after a thorough flushing, see a doctor immediately.
 - If ink gets into your mouth, see a doctor right away.

- Do not disassemble the ink supply unit and the maintenance box; otherwise ink may get into your eyes or on your skin.
- Do not shake ink supply units too vigorously; otherwise ink may leak from the ink supply units.
- Keep ink supply units and maintenance box out of the reach of children.

Printer Advisories and Warnings



Read and follow these instructions to avoid damaging the printer or your property. Make sure you keep this manual for future reference.

Advisories and Warnings for Setting Up the Printer

- Do not block or cover the vents and openings in the printer.
- Use only the type of power source indicated on the printer's label.
- Avoid using outlets on the same circuit as photocopiers or air control systems that regularly switch on and off.
- Avoid electrical outlets controlled by wall switches or automatic timers.
- Keep the entire computer system away from potential sources of electromagnetic interference, such as loudspeakers or the base units of cordless telephones.
- The power-supply cords should be placed to avoid abrasions, cuts, fraying, crimping, and kinking. Do not place objects on top of the power-supply cords and do not allow the power-supply cords to be stepped on or run over. Be particularly careful to keep all the power-supply cords straight at the ends.
- If you use an extension cord with the printer, make sure that the total ampere rating of the devices plugged into the extension cord does not exceed the cord's ampere rating. Also, make sure that the total ampere rating of all devices plugged into the wall outlet does not exceed the wall outlet's ampere rating.
- If you plan to use the printer in Germany, the building installation must be protected by a 10 or 16 amp circuit breaker to provide adequate short-circuit protection and over-current protection for the printer.
- When connecting the printer to a computer or other device with a cable, ensure the correct orientation of the connectors. Each connector has only one correct orientation. Inserting a connector in the wrong orientation may damage both devices connected by the cable.
- Place the printer on a flat, stable surface that extends beyond the base of the printer in all directions. The printer will not operate properly if it is tilted at an angle.
- Allow space above the printer so that you can fully raise the printer cover.
- Leave enough space in front of the printer for the paper to be fully ejected.
- Avoid places subject to rapid changes in temperature and humidity. Also, keep the printer away from direct sunlight, strong light, or heat sources.

Advisories and Warnings for Using the Printer

- Do not insert objects through the slots in the printer.
- Do not put your hand inside the printer during printing.
- Do not touch the white flat cable inside the printer.
- Do not use aerosol products that contain flammable gases inside or around the printer. Doing so may cause fire.

- ❑ Do not move the print head by hand; otherwise, you may damage the printer.
- ❑ Always turn the printer off using the  button. Do not unplug the printer or turn off the power at the outlet until the  light stops flashing.
- ❑ If you are not going to use the printer for a long period, be sure to unplug the power cord from the electrical outlet.

Advisories and Warnings for Using the LCD Screen

- ❑ The LCD screen may contain a few small bright or dark spots, and because of its features it may have an uneven brightness. These are normal and do not indicate that it is damaged in any way.
- ❑ Only use a dry, soft cloth for cleaning. Do not use liquid or chemical cleaners.
- ❑ The exterior cover of the LCD screen could break if it receives a heavy impact. Contact your dealer if the screen's surface chips or cracks, and do not touch or attempt to remove the broken pieces.

Advisories and Warnings for Connecting to the Internet

Do not connect this product to the Internet directly. Connect it in a network protected by a router or firewall.

Advisories and Warnings for Using the Printer with a Wireless Connection

- ❑ Radio waves from this printer may negatively affect the operation of medical electronic equipment, causing them to malfunction. When using this printer inside medical facilities or near medical equipment, follow directions from the authorized personnel representing the medical facilities, and follow all posted warnings and directions on the medical equipment.
- ❑ Radio waves from this printer may negatively affect the operation of automatically controlled devices such as automatic doors or fire alarms, and could lead to accidents due to malfunction. When using this printer near automatically controlled devices, follow all posted warnings and directions on these devices.

Notes on the Administrator Password

This printer allows you to set an administrator password to prevent unauthorized access or changes to the device settings and network settings stored in the product when connecting to a network.

Default Value of the Administrator Password

The default value of the administrator password is printed on the label on the product itself, such as the one shown. The position where the label is attached depends on the product, such as the side where the cover is opened, the back, or the bottom.

The following illustration is an example of the label attachment position on the side of the printer where the cover opens.

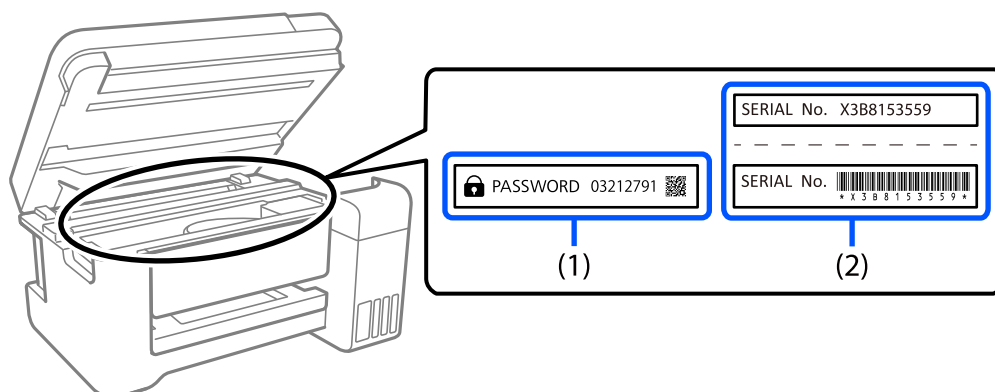

If both labels (1) and (2) are attached, the value next to PASSWORD written on the label in (1) is the default value. In this example, the default value is 03212791.

If only label (2) is attached, the serial number printed on the label in (2) is the default value. In this example, the default value is X3B8153559.

Changing the Administrator Password

It can be changed from the printer control panel and Web Config. When changing the password, set it with at least 8 single-byte alphanumeric characters and symbols.

Related Information

- ➔ [“Changing the Administrator Password from the Control Panel” on page 40](#)
- ➔ [“Changing the Administrator Password from the Computer” on page 40](#)

Operations that Require You to Enter the Administrator Password

If you are prompted to enter the administrator password when performing the following operations, enter the administrator password set on the printer.

- When updating the firmware of the printer from a computer or smart device
- When logging on to the advanced settings of Web Config
- When setting using an application that can change the printer's settings.
- When selecting a menu on the printer's control panel that has been locked by your administrator.

Related Information

- ➔ [“Target Items of Lock Setting” on page 218](#)

Initializing the Administrator Password

You can return the administrator password to the default settings from the administrator settings menu. If you have forgotten your password and cannot return to the default settings, you need to contact Epson Support to request service.

Related Information

- ➔ [“Changing the Administrator Password from the Control Panel” on page 40](#)
- ➔ [“Changing the Administrator Password from the Computer” on page 40](#)
- ➔ [“Where to Get Help” on page 275](#)

Advisories and Warnings for Transporting or Storing the Printer

- When storing or transporting the printer, avoid tilting it, placing it vertically, or turning it upside down; otherwise ink may leak.
- Before transporting the printer, make sure that the print head is in the home (far right) position, and the ink supply unit is installed.

Protecting Your Personal Information

When you give the printer to someone else or dispose of it, erase all the personal information stored in the printer's memory by selecting **Settings > General Settings > System Administration > Restore Default Settings > All Settings** on the control panel. Also, make sure you delete the printer's internal memory data by selecting **Settings > General Settings > System Administration > Clear Internal Memory Data > PDL Font, Macro, and Working Area** on the control panel.

Part Names and Functions

Front.	20
Inside.	22
Rear.	23

Front

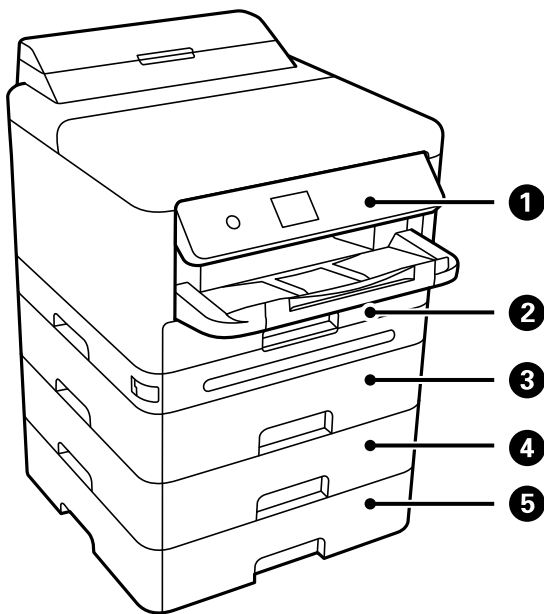

①	Control panel	Allows you to make settings and perform operations on the printer. Also displays the printer's status.
②	Paper cassette 1 or Paper cassette (C1)	Loads paper.
③	Paper cassette 2 (C2)	Optional paper cassette unit. Loads paper. You can install up to 3 paper cassette units.
④	Paper cassette 3 (C3)	
⑤	Paper cassette 4 (C4)	

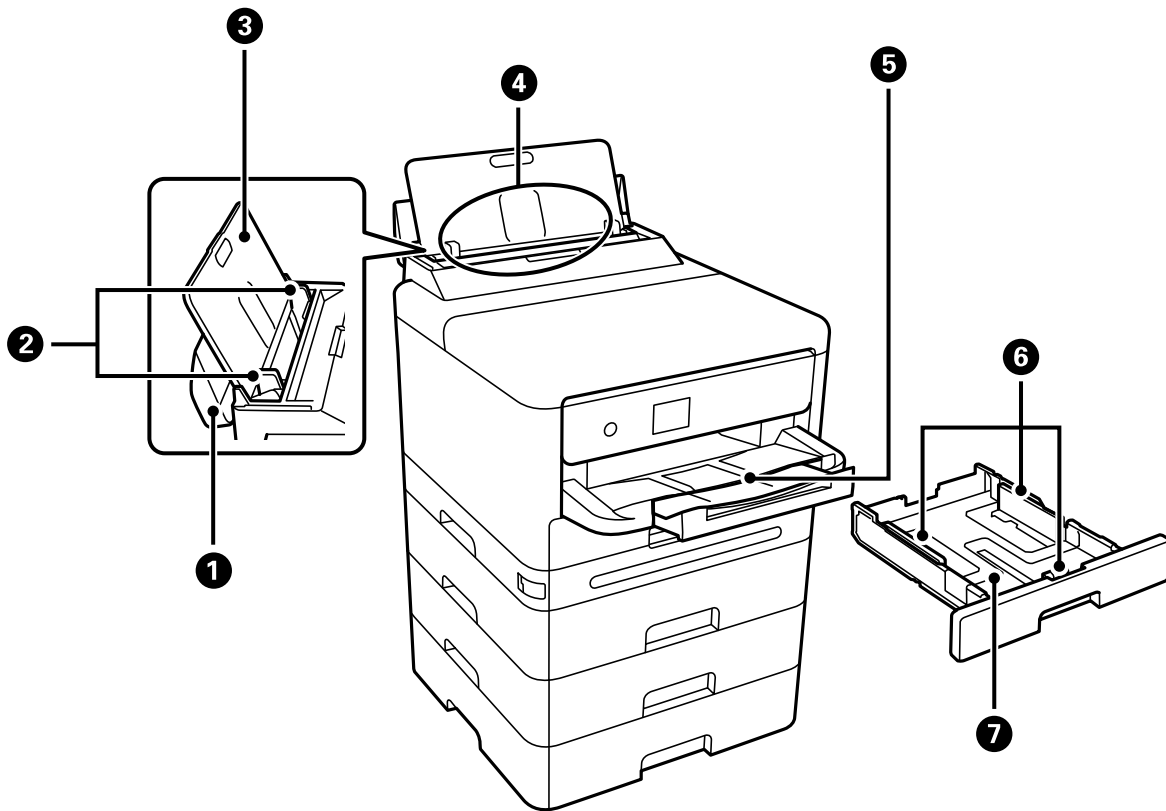

①	Paper tray cover	Prevents foreign substance from entering the printer. Usually keep this cover closed.
②	Edge guides	Feeds the paper straight into the printer. Slide to the edges of the paper.
③	Paper support	Supports loaded paper.
④	Paper tray (B)	Loads paper.
⑤	Output tray	Holds the ejected paper. Slide out the tray by hand and push it back in to store it.
⑥	Edge guides	Feeds the paper straight into the printer. Slide to the edges of the paper.
⑦	Paper cassette	Loads paper.

Inside

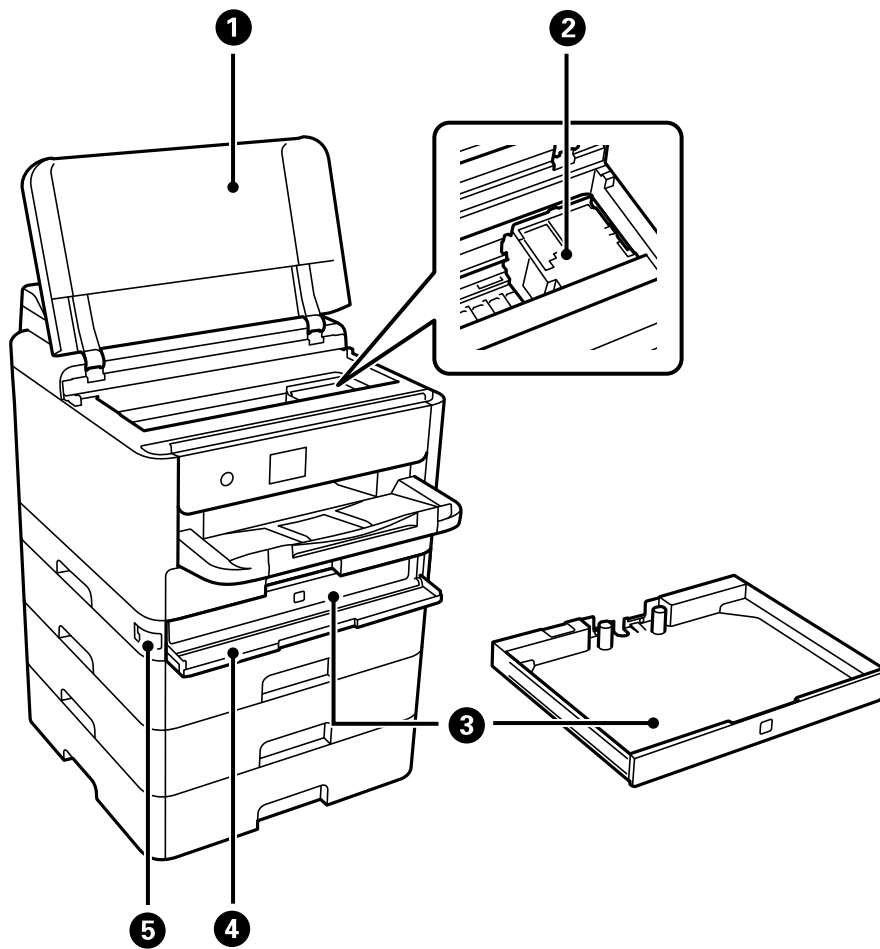

①	Printer cover (J)	Open to remove jammed paper. This cover should usually be kept closed.
②	Print head	Fires ink.
③	Ink tray	Sets an ink supply unit.
④	Ink cover (A)	Open when replacing ink supply units.
⑤	Cover lock	Locks the ink cover.

Rear

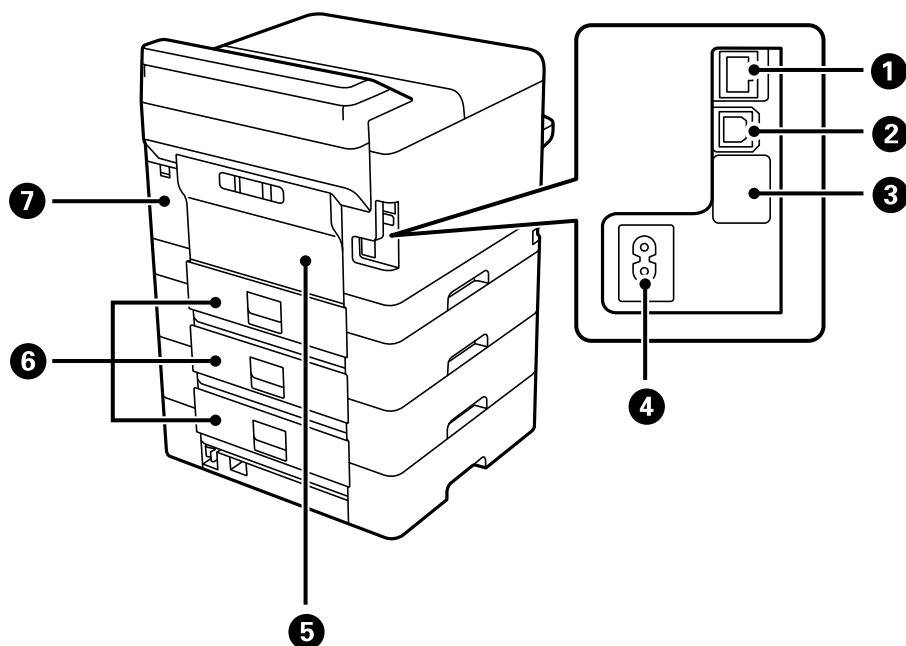

①	LAN port	Connects a LAN cable.
②	USB port	Connects a USB cable to connect with a computer.
③	Service USB port	USB port for future use. Do not remove the sticker.
④	AC inlet	Connects the power cord.
⑤	Rear cover (D)	Open when replacing the pickup roller or removing jammed paper.
⑥	Rear cover (E)	Open when replacing the pickup roller or removing jammed paper.
⑦	Maintenance box cover (H)	Open when replacing the maintenance box. The maintenance box is a container that collects a very small amount of surplus ink during cleaning or printing.

Guide to the Control Panel

Control Panel.	25
Home Screen Configuration.	26
Menu Screen Configuration.	28
Entering Characters.	28



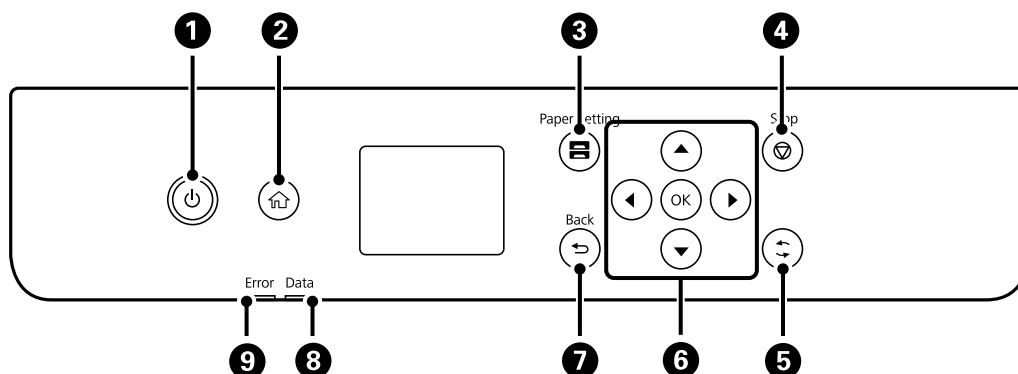

Control Panel

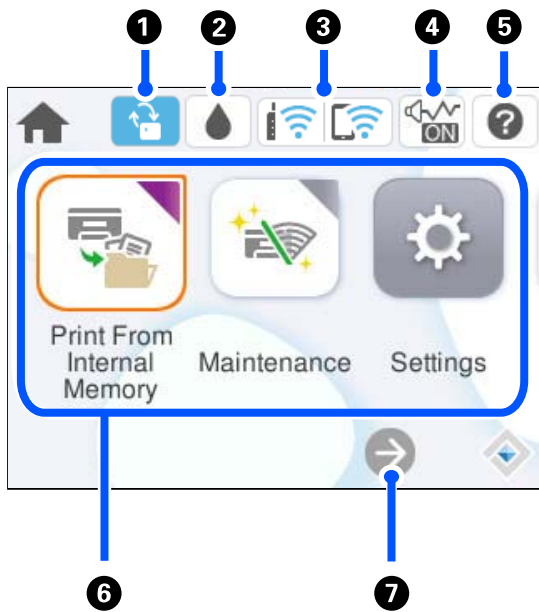

1	Turns the printer on or off. Unplug the power cord when the power light is off.
2	Displays the home screen.
3	Displays the Paper Setting screen. You can select the paper size and paper type settings for each paper source.
4	Stops the current operation.
5	Applies to a variety of functions depending on the situation.
6	Move the focus using the ◀▶▶▼ buttons to select the items, and then press the OK button to confirm your selection or run the selected feature.
7	Returns to the previous screen.
8	Flashes when the printer is processing data. It turns on when there are queued jobs.
9	Flashes or turns on when an error occurs.







Home Screen Configuration



1		<p>This is displayed when a firmware update is available.</p> <p>Select it to update the firmware to improve the printer's features. We recommend using the printer with the latest version of the firmware.</p>
2		<p>You can check the approximate ink levels and the approximate service life of the maintenance box.</p>
3		<p>Displays the network connection status. See the following for more details.</p> <p>"Guide to the Network Icon" on page 27</p>
4		<p>Indicates that Quiet Mode is set for the printer. When this feature is enabled, the noise made by printer operations is reduced, but print speed may slow down. However, noises may not be reduced depending on the selected paper type and print quality. Select to change the setting. You can also make this setting from the Settings menu.</p> <p>Settings > General Settings > Printer Settings > Quiet Mode</p>
5		<p>Displays the Help screen. You can view the operating instructions or the solutions to problems.</p>

<p>6</p>	<p>Displays each menu.</p> <ul style="list-style-type: none"> <input type="checkbox"/> Print From Internal Memory Allows you to temporarily save jobs sent from the printer driver to the printer's memory before printing. You can print a password protected job and test prints when printing multiple copies. <input type="checkbox"/> Maintenance Displays the menus recommended to improve the quality of your printouts such as unclogging nozzles by printing a nozzle check pattern and performing head cleaning, and improving blurring or banding in your printouts by aligning the print head. You can also make this settings from the Settings menu. Settings > Maintenance <input type="checkbox"/> Settings Allows you to make settings related to maintenance, printer settings, and operations. <input type="checkbox"/> Wi-Fi Displays menus that allow you to set up the printer for use on a wireless network. You can also make this setting from the Settings menu. Settings > General Settings > Network Settings > Wi-Fi Setup
<p>7</p>	<div style="display: flex; align-items: center;">  <p>Scrolls the screen to the right.</p> </div>

Guide to the Network Icon

	<p>The printer is not connected to a wired (Ethernet) network or a wireless (Wi-Fi) network.</p>
	<p>The printer is connected to a wired (Ethernet) network.</p>
	<p>The printer is searching for SSID, unset IP address, or having a problem with a wireless (Wi-Fi) network.</p>
	<p>The printer is connected to a wireless (Wi-Fi) network. The number of bars indicates the signal strength of the connection. The more bars there are, the stronger the connection.</p>
	<p>The printer is not connected to a wireless (Wi-Fi) network in Wi-Fi Direct (Simple AP) mode.</p>
	<p>The printer is connected to a wireless (Wi-Fi) network in Wi-Fi Direct (Simple AP) mode.</p>

Menu Screen Configuration

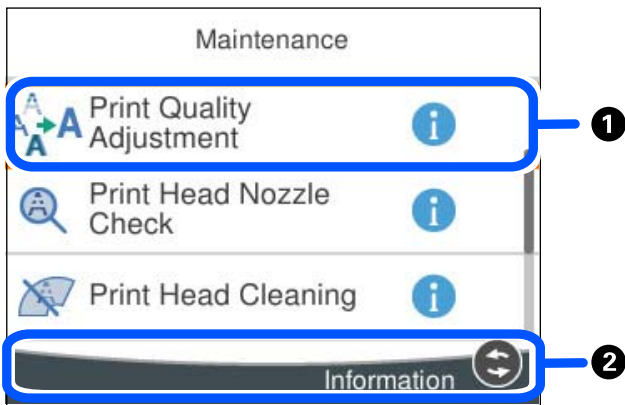

1	When  is displayed, you can view additional information by selecting the button shown in 2.
2	Available buttons are displayed.

Entering Characters

You can enter characters and symbols by using on-screen keyboard when you make network settings and so on.

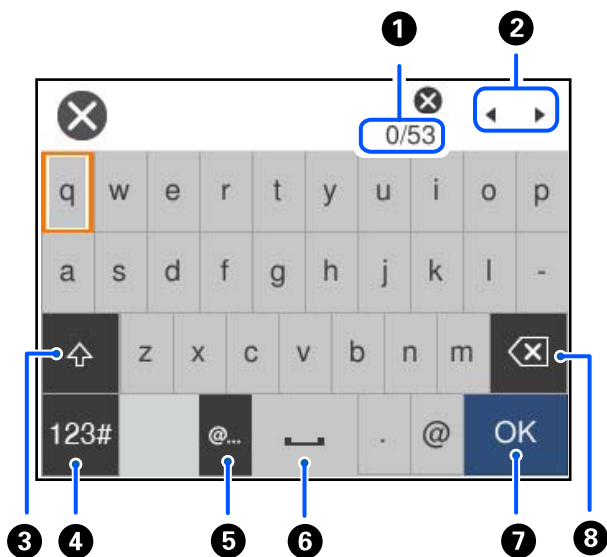

1	Indicates the character count.
2	Moves the cursor to the input position.
3	Switches between upper case and lower case.
4	Switches the character type. ABC: Alphabet 123#: Numbers and symbols

5	Enters frequently used email domain addresses or URLs by simply selecting the item.
6	Enters a space.
7	Enters character.
8	Deletes a character to the left. Deletes a character to the right when the cursor is at the start of the line and there are no characters to the left.

Preparing the Printer and Making Initial Settings

Summary of Preparing the printer and Making Initial Settings.	31
Installing the Optional Paper Cassette Units.	33
Mounting an Authentication Device.	38
Creating a Network Connection and Making Settings.	39
Preparing and Setting Up the Printer According to Use.	57
Initial Settings for Printing.	62
Problems when Making Settings.	72

Summary of Preparing the printer and Making Initial Settings

This section explains the work required to connect the printer to a network and use it as a shared printer.

This work should be done by the printer administrator.

Related Information

- ➔ [“Preparing the Printer” on page 31](#)
- ➔ [“Protecting Settings Using Panel Lock” on page 41](#)
- ➔ [“Configuring a Network Connection” on page 31](#)
- ➔ [“Summary of the Necessary Preparations for Each Feature” on page 32](#)
- ➔ [“Making Printer Settings” on page 32](#)

Preparing the Printer

During the preparatory stage, install optional items or an authentication device as needed.

Related Information

- ➔ [“Installing the Optional Paper Cassette Units” on page 33](#)
- ➔ [“Connecting the Authentication Device” on page 38](#)

Protecting the Printer from Unauthorized Setting Changes

We recommend performing the following operation to prevent the user from changing the printer settings.

- Changing the Administrator Password
- Set the **Panel Lock**, a feature that allows the printer administrator to lock control panel menu items.

Related Information

- ➔ [“Changing the Administrator Password” on page 40](#)
- ➔ [“Protecting Settings Using Panel Lock” on page 41](#)

Configuring a Network Connection

Connect the printer to a network so that it can be used as a shared printer.

When connecting to a network that allows external connections such as TCP/IP settings and an Internet connection, set the proxy server as necessary.

Related Information

- ➔ [“Creating a Network Connection and Making Settings” on page 39](#)

Summary of the Necessary Preparations for Each Feature

Perform the following operations according to how you will use the printer and the environment in which it will be used.

Items	Description
Configuring a Mail Server	Configure the mail server if you want to notify a specific person of the printer status by e-mail. “Configuring a Mail Server” on page 59
Initial Settings for Printing	Customize the paper feed device settings and print default settings to suit your environment. Make settings to use printing services provided by other companies.

For security settings and other management settings for the printer, see the related information link below.

Related Information

- ➔ [“Preparing and Setting Up the Printer According to Use” on page 57](#)
- ➔ [“Initial Settings for Printing” on page 62](#)
- ➔ [“Administrator Information” on page 216](#)

Making Printer Settings

Several methods are available when you make settings for the printer.

Related Information

- ➔ [“Setting from the Printer's Control Panel” on page 32](#)
- ➔ [“Setting Using Web Config from a Computer” on page 32](#)
- ➔ [“Setting Using Epson Device Admin from a Computer \(Windows Only\)” on page 33](#)

Setting from the Printer's Control Panel

If the panel lock is enabled, you will need an administrator password to operate the locked items.

See related information for more details.

Related Information

- ➔ [“Changing the Administrator Password” on page 17](#)

Setting Using Web Config from a Computer

Web Config is a built-in web page of the printer for configuring the printer's settings. You can operate the printer connected to the network from the computer.

To access Web Config, you need to have first assigned an IP address to the printer.

Note:

- ❑ Before setting the IP address, you can open Web Config by connecting the computer and printer directly with a LAN cable and specifying the default IP address.
- ❑ Since the printer uses a self-signed certificate when accessing HTTPS, a warning is displayed on the browser when you start Web Config; this does not indicate a problem and can be safely ignored.
- ❑ To open the administrative page after starting Web Config, you need to log in to the printer with the administrator password.

See related information for more details.

Related Information

- ➔ [“Changing the Administrator Password” on page 17](#)
- ➔ [“Application for Configuring Printer Operations \(Web Config\)” on page 182](#)

Setting Using Epson Device Admin from a Computer (Windows Only)

Use Epson Device Admin when setting up multiple printers in a batch.

Installing the Optional Paper Cassette Units

You can install up to 3 paper cassette units.

 **Caution:**

- ❑ Make sure you turn off the printer, unplug the power cord from the printer, and disconnect any cables before starting installation. Otherwise, the power cord may be damaged resulting in fire or electric shock.
- ❑ The printer is heavy and should not be lifted or carried by less than two people. If any paper cassettes other than Paper Cassette 1 are installed, uninstall them before lifting the printer. When lifting the printer, two or more people should assume the correct positions as shown below.

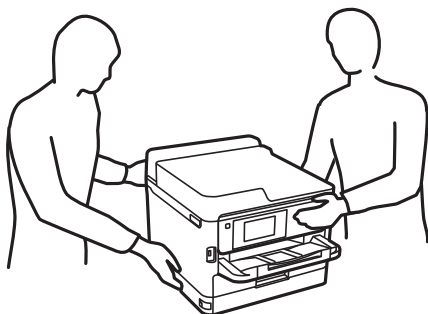

 **Important:**

- ❑ Prepare a screwdriver to install and uninstall the optional cassette units.
- ❑ Use an appropriate size and type of screwdriver. Otherwise, you may not be able to turn the screw or you may accidentally remove another screw.

1. Turn off the printer by pressing the  button, and then unplug the power cord.

2. Disconnect any connected cables.
3. If other optional paper cassette units have been installed, uninstall them using a screwdriver.

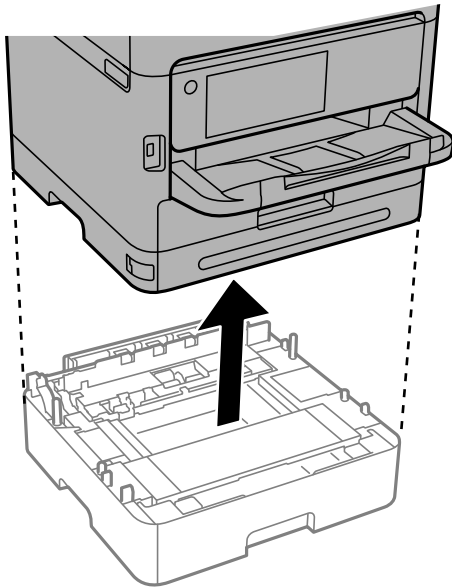

4. Remove the part on the back of the printer.

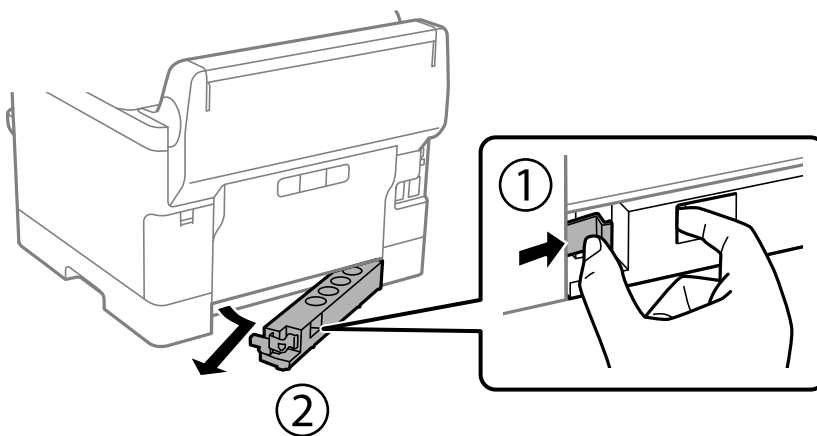

5. Remove the optional paper cassette unit from its box, and then remove any protective materials.
6. Check the items supplied.

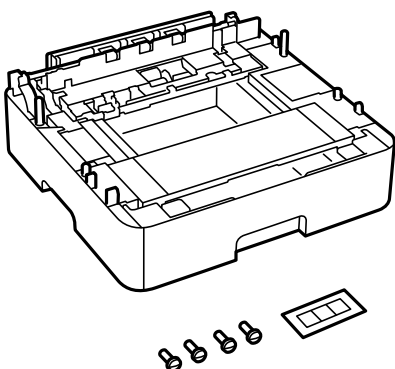

7. Place the lowest optional paper cassette unit where you want to set up the printer.
8. If you are only using one optional paper cassette unit, go to step 11. If you are using two or three optional cassette units, go to the next step.
9. Stack the optional paper cassette units on top of the lowest optional paper cassette unit, and then secure them with the screws using a screwdriver.

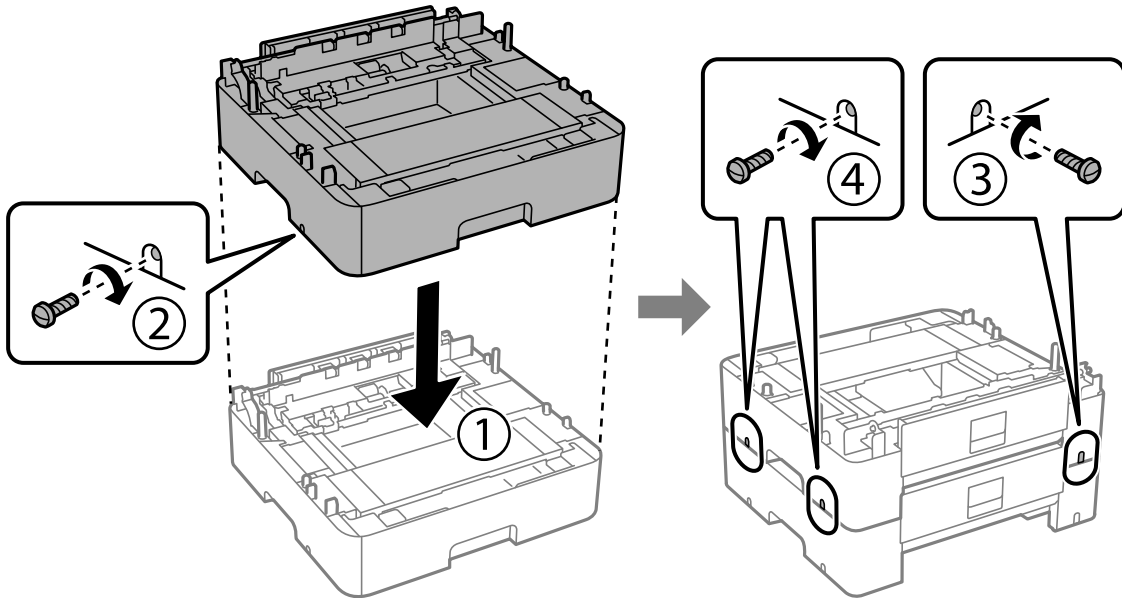

10. Repeat the previous step to add more optional paper cassette units.

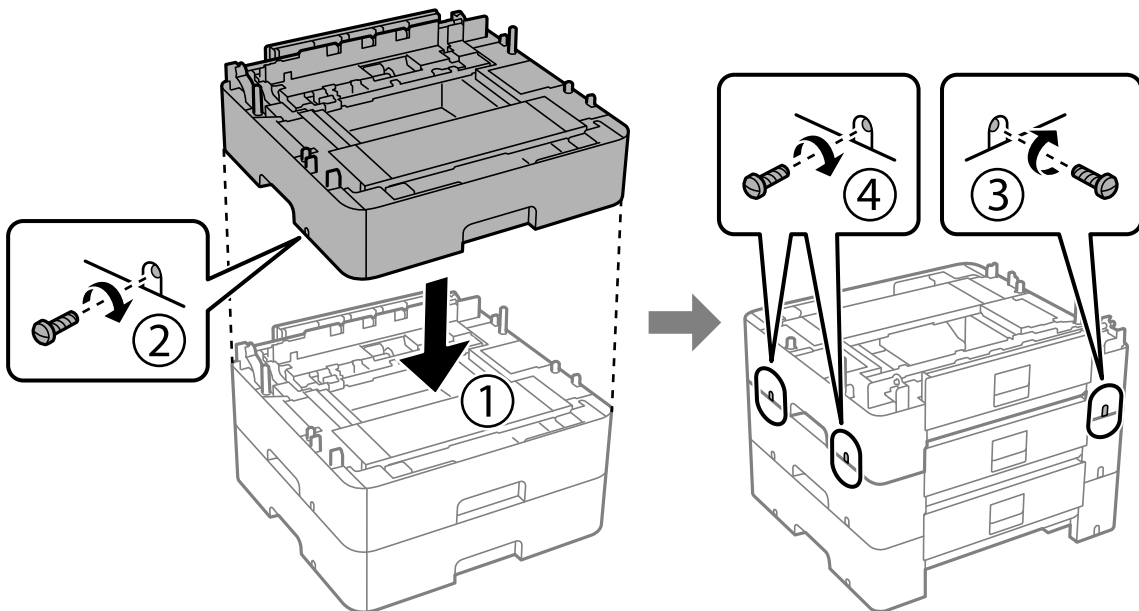

11. Lower the printer gently onto the optional paper cassette units aligning the corners, and then secure them with the screws using a screwdriver.

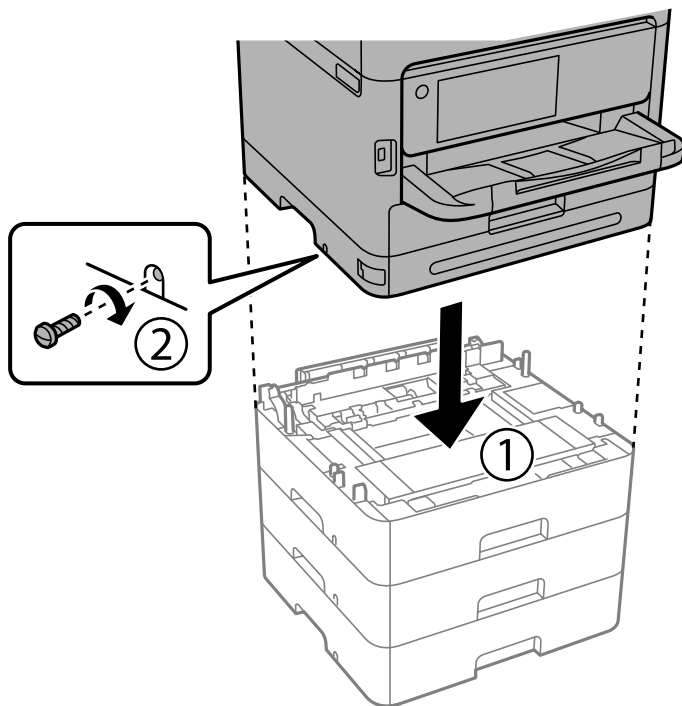

12. Secure the optional paper cassette units and the printer at the back and the right side with the screws using a screwdriver.

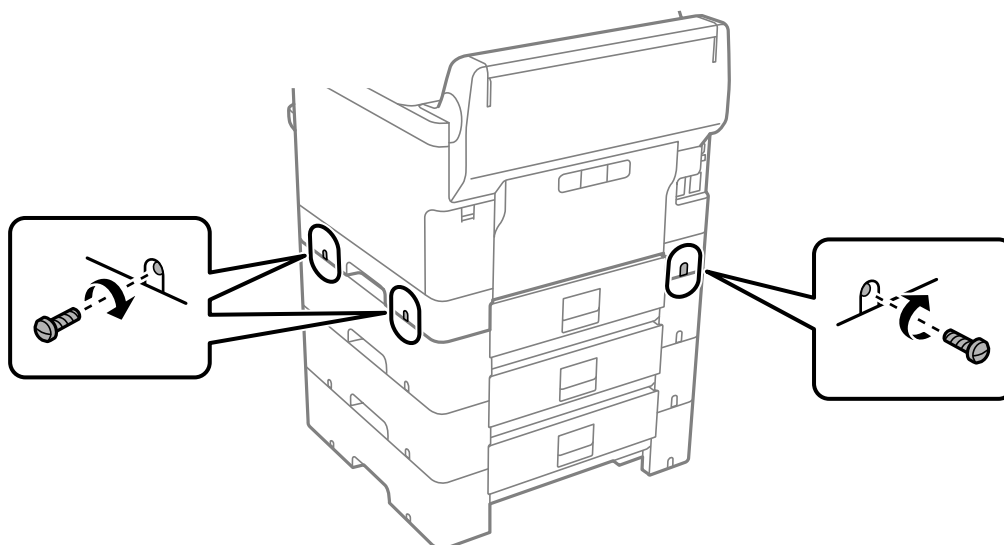

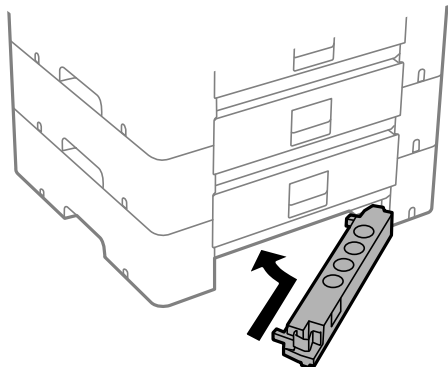

13. Attach the part that you removed in step 4 to the back of the lowest optional paper cassette unit.

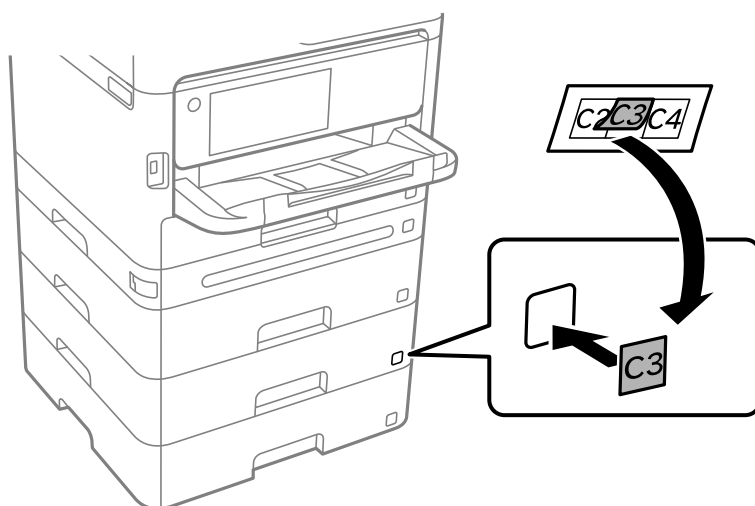

14. Place the sticker indicating the cassette number.



15. Reconnect the power cord and any other cables, and then plug in the printer.
16. Turn on the printer by pressing the  button.
17. Press the  button, and check that the optional cassette unit that you installed is displayed on the **Paper Setting** screen.

Note:

When uninstalling the optional paper cassette unit, turn off the printer, unplug the power cord, disconnect any cables, and then perform the installation procedure in reverse.

Proceed with the printer driver settings.

Related Information

- ➔ [“Setting Available Optional Items” on page 57](#)
- ➔ [“Optional Paper Cassette Unit Code” on page 178](#)

Mounting an Authentication Device

Connecting the Authentication Device

You can connect the authentication device by using a USB cable.

Note:

The authentication device can be used when using an authentication system.



Caution:

Connect an authentication device with the same model number as the authentication device that was used to confirm the authentication card.

1. Peel off the sticker for the service port (a) on the back of the printer.

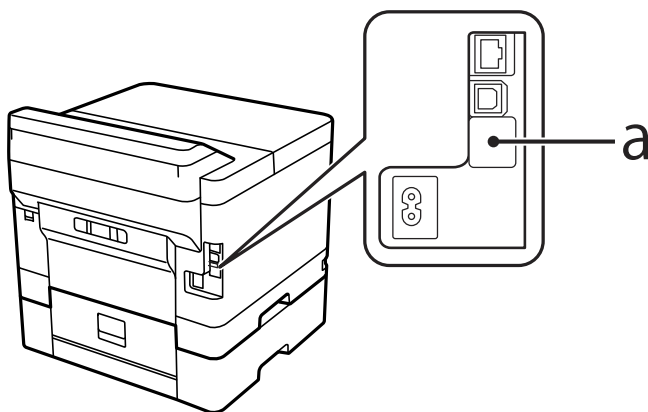

2. Connect the USB cable for the authentication device to the service port.

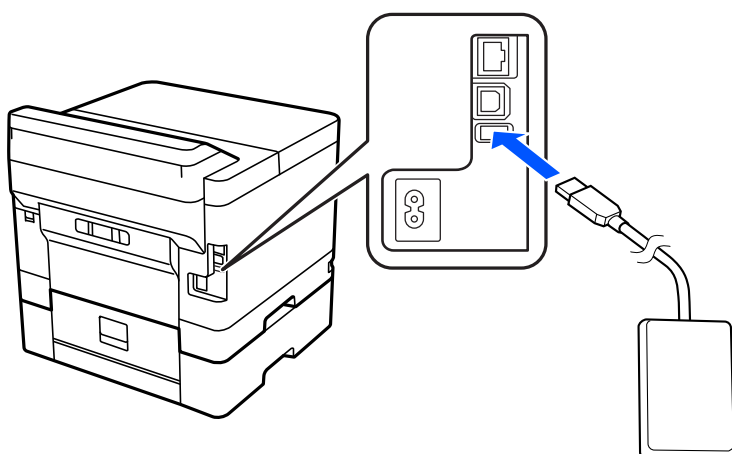

Confirming the Connection Status of the Authentication Device

You can use several methods to confirm the connection status of the authentication device.

Printer's control panel

Settings > Authentication Device Status

Web Config

You can confirm from either of the following menus.

- Status tab > Product Status > Card Reader Status**
- Device Management tab > Card Reader > Check**

Confirming the Authentication Card is Recognized

You can check that authentication cards can be recognized by using Web Config.

1. Enter the printer's IP address into a browser to access Web Config.
Enter the printer's IP address from a computer that is connected to the same network as the printer.
You can check the IP address of the printer from the following menu.
Settings > General Settings > Network Settings > Network Status > Wired LAN/Wi-Fi Status
2. Enter the administrator password to log in as an administrator.
3. Select in the following order.
Device Management tab > Card Reader
4. Hold the authentication card over the authentication device.
5. Click **Check**.
The result is displayed.

Troubleshooting the Authentication Device

Cannot Read the Authentication Card

Check the following.

- Check if the authentication device is connected to the printer correctly.
Make sure you connect the authentication device to the service port of the printer.
- Check that the authentication device and the authentication card are certified.
Contact your dealer for information on supported authentication devices and cards.

Creating a Network Connection and Making Settings

This section explains the necessary settings so that users in the same network can use the printer.

Changing the Administrator Password

An administrator password is set for the printer. We recommend changing the initial password before using the printer.

If you forget the administrator password, you will not be able to change the settings for items that have been locked using **Panel Lock**, and you will need to contact service support to have it unlocked.

Related Information

- ➔ [“Notes on the Administrator Password” on page 16](#)
- ➔ [“Changing the Administrator Password from the Control Panel” on page 40](#)
- ➔ [“Changing the Administrator Password from the Computer” on page 40](#)

Changing the Administrator Password from the Control Panel

1. Select **Settings** on the printer's control panel.
2. Select **General Settings > System Administration > Security Settings > Admin Settings > Admin Password > Change**.

3. Enter a current password.

Note:

See the related information below for the default of administrator password.

4. Follow the on-screen instructions to set a new password.

Note:

To restore the administrator password to its default, select the following menus on the control panel.

General Settings > System Administration > Security Settings > Admin Settings > Admin Password > Restore Default Settings

Related Information

- ➔ [“Changing the Administrator Password” on page 17](#)

Changing the Administrator Password from the Computer

You can set the administrator password using Web Config. When using Web Config, it is necessary to connect the printer to the network. If the printer is not connect to the network, connect the to the computer with an ethernet cable directly.

1. Enter the printer's IP address into a browser to access Web Config.
Enter the printer's IP address from a computer that is connected to the same network as the printer.

You can check the IP address of the printer from the following menu.

Settings > General Settings > Network Settings > Network Status > Wired LAN/Wi-Fi Status

2. Enter the administrator password to log in as an administrator.
Select **Log in**, and then enter the administrator password, and click **OK**.

3. Select **Product Security-Change Administrator Password**.
4. Enter a password in **Current password** and **New Password** and **Confirm New Password**. Enter the user name, if necessary.

Note:

See the related information below for the default of administrator password.

5. Select **OK**.

Note:

To restore the administrator password to the initial password, select **Restore Default Settings** on the **Change Administrator Password** screen.

Related Information

➔ [“Changing the Administrator Password” on page 17](#)

Protecting Settings Using Panel Lock

To prevent unauthorized users from viewing or changing printer settings or network settings when connected to the network, administrators can lock the control panel menu items by using the Panel Lock function. You need to log in as an administrator to operate the locked menu items.

Note:

You can change the password later.

Related Information

➔ [“Setting the Control Panel” on page 217](#)

Enabling the Lock Setting from the Control Panel

1. Select **Settings** on the printer's control panel.
2. Select **General Settings** > **System Administration** > **Security Settings** > **Admin Settings**.
3. Select **On** on **Lock Setting**.

Select **Settings** > **General Settings** > **Network Settings**, and then check that the password is required.

Related Information

➔ [“Default Value of the Administrator Password” on page 16](#)

Enabling the Lock Setting from a Computer

1. Enter the printer's IP address into a browser to access Web Config.
Enter the printer's IP address from a computer that is connected to the same network as the printer.
You can check the IP address of the printer from the following menu.
Settings > **General Settings** > **Network Settings** > **Network Status** > **Wired LAN/Wi-Fi Status**

2. Enter the password, and then click **OK**.
3. Select in the following order.
Device Management tab > **Control Panel**
4. On the **Panel Lock**, select **ON**.
5. Click **OK**.
6. Select **Settings** > **General Settings** > **Network Settings** on the printer's control panel, and then check that the password is required.

Related Information

- ➔ [“Default Value of the Administrator Password” on page 16](#)
- ➔ [“Application for Configuring Printer Operations \(Web Config\)” on page 182](#)

Connecting the Printer to the Network

You can connect the printer to the network in several ways.

- Connect by using advanced settings on the control panel.
- Connect by using the installer on the website or on the software disc.

This section explains the procedure to connect the printer to the network using the printer's control panel.

Before Making Network Connection

To connect to the network, check the connection method and setting information for connection in advance.

Gathering Information on the Connection Setting

Prepare the necessary setting information to connect. Check the following information in advance.

Divisions	Items	Note
Device connection method	<input type="checkbox"/> Ethernet <input type="checkbox"/> Wi-Fi	Decide how to connect the printer to the network. For Wired LAN, connects to the LAN switch. For Wi-Fi, connects to the network (SSID) of the access point.
LAN connection information	<input type="checkbox"/> IP address <input type="checkbox"/> Subnet mask <input type="checkbox"/> Default gateway	Decide the IP address to assign to the printer. When you assign the IP address statically, all values are required. When you assign the IP address dynamically using the DHCP function, this information is not required because it is set automatically.

Divisions	Items	Note
Wi-Fi connection information	<input type="checkbox"/> SSID <input type="checkbox"/> Password	These are the SSID (network name) and the password of the access point that the printer connects to. If MAC address filtering has been set, register the MAC address of the printer in advance to register the printer. See the following for the supported standards. "Wi-Fi Specifications" on page 200
DNS server information	<input type="checkbox"/> IP address for primary DNS <input type="checkbox"/> IP address for secondary DNS	These are required when specifying DNS servers. The secondary DNS is set when the system has a redundant configuration and there is a secondary DNS server. If you are in a small organization and do not set the DNS server, set the IP address of the router.
Proxy server information	<input type="checkbox"/> Proxy server name	Set this when your network environment uses the proxy server to access the internet from the intranet, and you use the function that the printer directly accesses to the internet. For the following functions, the printer directly connects to the internet . <input type="checkbox"/> Epson Connect Services <input type="checkbox"/> Cloud services of other companies <input type="checkbox"/> Firmware updating
Port number information	<input type="checkbox"/> Port number to release	Check the port number used by the printer and computer, then release the port that is blocked by a firewall, if necessary. See the following for the port number used by the printer. "Using Port for the Printer" on page 199

IP Address Assignment

These are the following types of IP address assignment.

Static IP address:

Assign the predetermined IP address to the printer (host) manually.

The information to connect to the network (subnet mask, default gateway, DNS server and so on) need to be set manually.

The IP address does not change even when the device is turned off, so this is useful when you want to manage devices with an environment where you cannot change the IP address or you want to manage devices using the IP address. We recommend settings to the printer, server, etc. that many computers access. Also, when using security features such as IPsec / IP filtering, assign a fixed IP address so that the IP address does not change.

Automatic assignment by using DHCP function (dynamic IP address):

Assign the IP address automatically to the printer (host) by using the DHCP function of the DHCP server or router.

The information to connect to the network (subnet mask, default gateway, DNS server and so on) is set automatically, so you can easily connect the device to the network.

If the device or the router is turned off, or depending on the DHCP server settings, IP address may change when re-connecting.

We recommend managing devices other than the IP address and communicating with protocols that can follow the IP address.

Note:

When you use the IP address reservation function of the DHCP, you can assign the same IP address to the devices at any time.

DNS Server and Proxy Server

The DNS server has a host name, domain name of the email address, etc. in association with the IP address information.

Communication is impossible if the other party is described by host name, domain name, etc. when the computer or the printer performs IP communication.

Queries the DNS server for that information and gets the IP address of the other party. This process is called name resolution.

Therefore, the devices such as computers and printers can communicate using the IP address.

Name resolution is necessary for the printer to communicate using the email function or Internet connection function.

When you use those functions, make the DNS server settings.

When you assign the printer's IP address by using the DHCP function of the DHCP server or router, it is automatically set.

The proxy server is placed at the gateway between the network and the Internet, and it communicates to the computer, printer, and Internet (opposite server) on behalf of each of them. The opposite server communicates only to the proxy server. Therefore, printer information such as the IP address and port number cannot be read and increased security is expected.

When you connect to the Internet via a proxy server, configure the proxy server on the printer.

Connecting to the Network from the Control Panel

Connect the printer to the network by using the printer's control panel.

Assigning the IP Address

Set up the basic items such as **IP Address**, **Subnet Mask**, **Default Gateway**.

This section explains the procedure for setting a static IP address.

1. Turn on the printer.
2. Select **Settings > General Settings > Network Settings >** on the home screen on the printer's control panel.
3. Select **Advanced > TCP/IP**.

Note:

You need to enter the administrator password for the network.

4. Select **Manual** for **Obtain IP Address**.

When you set the IP address automatically by using the DHCP function of router, select **Auto**. In that case, the **IP Address**, **Subnet Mask**, and **Default Gateway** on step 5 to 6 are also set automatically, so go to step 7.

5. Enter the IP address.
Confirm the value reflected on the previous screen.
6. Set up the **Subnet Mask** and **Default Gateway**.
Confirm the value reflected on the previous screen.



Important:

*If the combination of the **IP Address**, **Subnet Mask** and **Default Gateway** is incorrect, **Start Setup** is inactive and cannot proceed with the settings. Confirm that there is no error in the entry.*

7. Enter the IP address for the primary DNS server.
Confirm the value reflected on the previous screen.

When you select **Auto** for the IP address assignment settings, you can select the DNS server settings from **Manual** or **Auto**. If you cannot obtain the DNS server address automatically, select **Manual** and enter the DNS server address. Then, enter the secondary DNS server address directly. If you select **Auto**, go to step 9.
8. Enter the IP address for the secondary DNS server.
Confirm the value reflected on the previous screen.
9. Select **Start Setup**.

Setting the Proxy Server

Set up the proxy server if both of the following are true.

- The proxy server is built for Internet connection.
- When using a function in which a printer directly connects to the Internet, such as Epson Connect service or another company's cloud services.

1. Select **Settings** on the home screen.
When making settings after IP address setting, the **Advanced** screen is displayed. Go to step 3.
2. Select **General Settings > Network Settings > Advanced**.
3. Select **Proxy Server**.
4. Select **Use** for **Proxy Server Settings**.
5. Enter the address for the proxy server by IPv4 or FQDN format.
Confirm the value reflected on the previous screen.
6. Enter the port number for the proxy server.
Confirm the value reflected on the previous screen.
7. Select **Start Setup**.

Connecting to Ethernet

Connect the printer to the network by using an Ethernet cable, and check the connection.

1. Connect the printer and hub (LAN switch) by Ethernet cable.
2. Select **Settings** on the home screen.
3. Select **General Settings > Network Settings > Connection Check**.

The connection diagnosis result is displayed. Confirm the connection is correct.

Connecting to the Wireless LAN (Wi-Fi)

You can connect the printer to the wireless LAN (Wi-Fi) in several ways. Choose the connection method that matches the environment and conditions that you are using.

If you know the information for the wireless router such as SSID and password, you can make settings manually.

If the wireless router supports WPS, you can make settings by using push button setup.

After connecting the printer to the network, connect to the printer from the device that you want to use (computer, smart device, tablet, and so on.)

Related Information

- ➔ [“Note when Using a Wi-Fi 5 GHz Connection” on page 46](#)
- ➔ [“Making Wi-Fi Settings by Entering the SSID and Password” on page 46](#)
- ➔ [“Making Wi-Fi Settings by Push Button Setup \(WPS\)” on page 47](#)
- ➔ [“Making Wi-Fi Settings by PIN Code Setup \(WPS\)” on page 48](#)

Note when Using a Wi-Fi 5 GHz Connection

This printer normally uses W52 (36ch) as the channel when connecting to Wi-Fi Direct (Simple AP). Since the channel for wireless LAN (Wi-Fi) connection is selected automatically, the channel used may differ when used at the same time as a Wi-Fi Direct connection. Sending data to the printer may be delayed if the channels are different. If it does not interfere with use, connect to the SSID in the 2.4 GHz band. In the 2.4 GHz frequency band, the channels used will match.

When setting the wireless LAN to 5 GHz, we recommend disabling Wi-Fi Direct.

Making Wi-Fi Settings by Entering the SSID and Password

You can set up a Wi-Fi network by entering the information necessary to connect to a wireless router from the printer's control panel. To set up using this method, you need the SSID and password for a wireless router.

Note:

If you are using an wireless router with its default settings, the SSID and password are on the label. If you do not know the SSID and password, contact the person who set up the wireless router, or see the documentation provided with the wireless router.

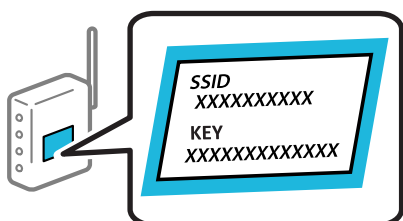

1. Select **Wi-Fi** on the home screen.

To select an item, use the ▲ ▼ ◀▶ buttons, and then press the OK button.

2. Select **Router**.

3. Press the OK button.

If the network connection is already set up, the connection details are displayed. Select **Change to Wi-Fi connection.** or **Change Settings** to change the settings.

4. Select **Wi-Fi Setup Wizard**.

5. Follow the on-screen instructions to select the SSID, enter the password for the wireless router, and start setup.

If you want to check the network connection status for the printer after setup is complete, see the related information link below for details.

Note:

If you do not know the SSID, check if it is written on the label of the wireless router. If you are using the wireless router with its default settings, use the SSID written on the label. If you cannot find any information, see the documentation provided with the wireless router.

The password is case-sensitive.

If you do not know the password, check if the information is written on the label of the wireless router. On the label, the password may be written "Network Key", "Wireless Password", and so on. If you are using the wireless router with its default settings, use the password written on the label.

Related Information

➔ [“Checking the Printer's Network Connection Status \(Network Connection Report\)” on page 137](#)

➔ [“Printing a Network Connection Report” on page 48](#)

Making Wi-Fi Settings by Push Button Setup (WPS)

You can automatically set up a Wi-Fi network by pressing a button on the wireless router. If the following conditions are met, you can set up by using this method.

The wireless router is compatible with WPS (Wi-Fi Protected Setup).

The current Wi-Fi connection was established by pressing a button on the wireless router.

Note:

If you cannot find the button or you are setting up using the software, see the documentation provided with the wireless router.

1. Select **Wi-Fi** on the home screen.

To select an item, use the ▲ ▼ ◀▶ buttons, and then press the OK button.

2. Select **Router**.

3. Press the OK button.

If the network connection is already set up, the connection details are displayed. Select **Change to Wi-Fi connection.** or **Change Settings** to change the settings.

4. Select **Push Button Setup (WPS)**.

5. Follow the on-screen instructions.

If you want to check the network connection status for the printer after setup is complete, see the related information link below for details.

Note:

If connection fails, restart the wireless router, move it closer to the printer, and try again. If it still does not work, print a network connection report and check the solution.

Related Information

➔ [“Printing a Network Connection Report” on page 48](#)

Making Wi-Fi Settings by PIN Code Setup (WPS)

You can automatically connect to an wireless router by using a PIN code. You can use this method to set up if an wireless router is capable of WPS (Wi-Fi Protected Setup). Use a computer to enter a PIN code into the wireless router.

1. Select **Wi-Fi** on the home screen.

To select an item, use the ▲ ▼ ◀▶ buttons, and then press the OK button.

2. Select **Router**.

3. Press the OK button.

If the network connection is already set up, the connection details are displayed. Select **Change to Wi-Fi connection**, or **Change Settings** to change the settings.

4. Select **Others > PIN Code Setup (WPS)**

5. Follow the on-screen instructions.

If you want to check the network connection status for the printer after setup is complete, see the related information link below for details.

Note:

See the documentation provided with your wireless router for details on entering a PIN code.

Related Information

➔ [“Printing a Network Connection Report” on page 48](#)

Troubleshooting Network Connections

Printing a Network Connection Report

You can print a network connection report to check the status between the printer and the wireless router.

1. Select **Settings** on the home screen.

To select an item, use the ▲ ▼ ◀▶ buttons, and then press the OK button.

2. Select **General Settings** > **Network Settings** > **Connection Check**.

The connection check starts.

3. Select **Print Check Report**.

4. Print the network connection report.

If an error has occurred, check the network connection report, and then follow the printed solutions.

Related Information

➔ [“Network Settings” on page 191](#)

➔ [“Messages and Solutions on the Network Connection Report” on page 52](#)

Cannot Connect to the Network

The IP address is incorrectly assigned.

If the IP address assigned to the printer is 169.254.XXX.XXX, and the subnet mask is 255.255.0.0, the IP address may not be assigned correctly.

Settings > **General Settings** > **Network Settings** > **Advanced** > **TCP/IP** on the printer’s control panel, and then check the IP address and the subnet mask assigned to the printer.

Restart the wireless router or reset the network settings for the printer.

If the printer network settings are incorrect, reconfigure the printer network settings according to the network environment.

Related Information

➔ [“Connecting to the Network from the Control Panel” on page 44](#)

The printer has been connected by Ethernet using devices that support IEEE802.3az (Energy Efficient Ethernet).

When you connect the printer by Ethernet using devices that support IEEE802.3az (Energy Efficient Ethernet), the following problems may occur depending on the hub or router that you are using.

- Connection becomes unstable, the printer is connected and disconnected again and again.
- Cannot connect to the printer.
- The communication speed becomes slow.

Follow the steps below to disable IEEE802.3az for the printer and then connect.

1. Remove the Ethernet cable connected to the computer and the printer.
2. When IEEE802.3az for the computer is enabled, disable it.
See the documentation provided with the computer for details.
3. Connect the computer and the printer with an Ethernet cable directly.

4. On the printer, print a network connection report.
 [“Printing a Network Connection Report” on page 48](#)
 5. Check the printer's IP address on the network connection report.
 6. On the computer, access Web Config.
 Launch a Web browser, and then enter the printer's IP address.
 [“Running Web Config on a Web Browser” on page 183](#)
 7. Select the **Network** tab > **Wired LAN**.
 8. Select **OFF** for **IEEE 802.3az**.
 9. Click **Next**.
 10. Click **OK**.
 11. Remove the Ethernet cable connected to the computer and the printer.
 12. If you disabled IEEE802.3az for the computer in step 2, enable it.
 13. Connect the Ethernet cables that you removed in step 1 to the computer and the printer.
- If the problem still occurs, devices other than the printer may be causing the problem.

Something is wrong with the network devices for Wi-Fi connection.

Try the following if you can reset the wireless LAN router in your environment.

Turn off the devices you want to connect to the network. Wait for about 10 seconds, and then turn on the devices in the following order; wireless router, computer or smart device, and then printer. Move the printer and computer or smart device closer to the wireless router to help with radio wave communication, and then try to make network settings again.

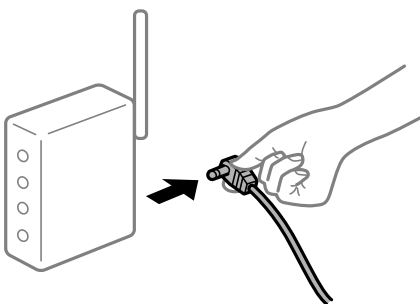

Devices cannot receive signals from the wireless router because they are too far apart.

Try the following if you can move the device within the setup environment.

After moving the computer or the smart device and the printer closer to the wireless router, turn off the wireless router, and then turn it back on.

When changing the wireless router, the settings do not match the new router.

Make the connection settings again so that they match the new wireless router.

Related Information

➔ [“Connecting to the Network from the Control Panel” on page 44](#)

The SSIDs connected from the computer or smart device and computer are different.

When you are using multiple wireless routers at the same time or the wireless router has multiple SSIDs and devices are connected to different SSIDs, you cannot connect to the wireless router.

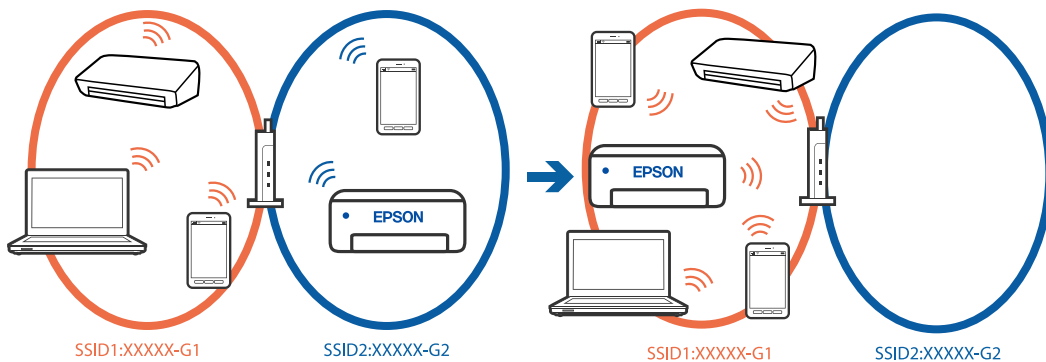

Connect the computer or smart device to the same SSID as the printer.

- Check the SSID that the printer is connected to by printing out the network connection check report.
- On all of the computers and smart devices you want to connect to the printer, check the name of the Wi-Fi or network you are connected to.
- If the printer and your computer or smart device are connected to different networks, reconnect the device to the SSID that the printer is connected to.

A privacy separator on the wireless router is available.

Most wireless routers have a separator function that blocks communication between devices within the same SSID. If you cannot communicate between the printer and the computer or smart device even if they are connected to the same network, disable the separator function on the wireless router. See the manual provided with the wireless router for details.

Messages and Solutions on the Network Connection Report

Check the messages and error codes on the network connection report, and then follow the solutions.

Check Network Connection

Check Result FAIL

Error code (E-2)

See the Network Status and check if the Network Name (SSID) is the SSID you want to connect.
If the SSID is correct, make sure to enter the correct password and try again.

If your problems persist,
see your documentation for help and networking tips.

Checked Items

Wireless Network Name (SSID) Check	FAIL
Communication Mode Check	Unchecked
Security Mode Check	Unchecked
MAC Address Filtering Check	Unchecked
Security Key/Password Check	Unchecked
IP Address Check	Unchecked
Detailed IP Setup Check	Unchecked

Network Status

Printer Name	EPSON XXXXXX
Printer Model	XX-XXX Series
IP Address	169.254.137.8
Subnet Mask	255.255.0.0
Default Gateway	
Network Name (SSID)	EpsonNet
Security	None
Signal Strength	Poor
MAC Address	F8:D0:27:40:C0:AC

a. Error code

b. Messages on the Network Environment

Related Information

- ➔ “E-1” on page 53
- ➔ “E-2, E-3, E-7” on page 53
- ➔ “E-5” on page 54
- ➔ “E-6” on page 54
- ➔ “E-8” on page 54
- ➔ “E-9” on page 55
- ➔ “E-10” on page 55
- ➔ “E-11” on page 55
- ➔ “E-12” on page 56
- ➔ “E-13” on page 56
- ➔ “Message on the Network Environment” on page 57

E-1

Solutions:

- Make sure the Ethernet cable is securely connected to your printer and to your hub or other network device.
- Make sure your hub or other network device is turned on.
- If you want to connect the printer by Wi-Fi, make Wi-Fi settings for the printer again because it is disabled.

E-2, E-3, E-7

Solutions:

- Make sure your wireless router is turned on.
- Confirm that your computer or device is connected correctly to the wireless router.
- Turn off the wireless router. Wait for about 10 seconds, and then turn it on.
- Place the printer closer to your wireless router and remove any obstacles between them.
- If you have entered the SSID manually, check if it is correct. Check the SSID from the **Network Status** part on the network connection report.
- If an wireless router has multiple SSIDs, select the SSID that is displayed. When the SSID is using a non-compliant frequency, the printer does not display them.
- If you are using push button setup to establish a network connection, make sure your wireless router supports WPS. You cannot use push button setup if your wireless router does not support WPS.
- Makes sure your SSID uses only ASCII characters (alphanumeric characters and symbols). The printer cannot display an SSID that contains non-ASCII characters.
- Makes sure you know your SSID and password before connecting to the wireless router. If you are using a wireless router with its default settings, the SSID and password are located on a label on the wireless router. If you do not know your SSID and password, contact the person who set up the wireless router, or see the documentation provided with the wireless router.
- If you are connecting to an SSID generated from a tethering smart device, check for the SSID and password in the documentation provided with the smart device.
- If your Wi-Fi connection suddenly disconnects, check for the conditions below. If any of these conditions are applicable, reset your network settings by downloading and running the software from the following website.
<https://epson.sn> > **Setup**
 - Another smart device was added to the network using push button setup.
 - The Wi-Fi network was set up using any method other than push button setup.

Related Information

- ➔ [“Making Settings for Connecting to the Computer” on page 137](#)
- ➔ [“Connecting to the Wireless LAN \(Wi-Fi\)” on page 46](#)

E-5

Solutions:

Make sure the wireless router's security type is set to one of the following. If it is not, change the security type on the wireless router, and then reset the printer's network settings.

- WEP-64 bit (40 bit)
- WEP-128 bit (104 bit)
- WPA PSK (TKIP/AES)*
- WPA2 PSK (TKIP/AES)*
- WPA (TKIP/AES)
- WPA2 (TKIP/AES)
- WPA3-SAE (AES)
- WPA2/WPA3-Enterprise

* WPA PSK is also known as WPA Personal. WPA2 PSK is also known as WPA2 Personal.

E-6

Solutions:

- Check if MAC address filtering is disabled. If it is enabled, register the printer's MAC address so that it is not filtered. See the documentation provided with the wireless router for details. You can check the printer's MAC address from the **Network Status** part on the network connection report.
- If your wireless router is using shared authentication with WEP security, make sure the authentication key and index are correct.
- If the number of connectable devices on the wireless router is less than the number of network devices that you want to connect, make settings on the wireless router to increase the number of connectable devices. See the documentation provided with the wireless router to make settings.

Related Information

➔ [“Making Settings for Connecting to the Computer” on page 137](#)

E-8

Solutions:

- Enable DHCP on the wireless router if the printer's Obtain IP Address setting is set to Auto.
- If the printer's Obtain IP Address setting is set to Manual, the IP address you manually set is invalid due to out of range (for example: 0.0.0.0). Set a valid IP address from the printer's control panel.

Related Information

➔ [“Assigning the IP Address” on page 44](#)

E-9

Solutions:

Check the following.

- Devices are turned on.
- You can access the Internet and other computers or network devices on the same network from the devices you want to connect to the printer.

If still does not connect your printer and network devices after confirming the above, turn off the wireless router. Wait for about 10 seconds, and then turn it on. Then reset your network settings by downloading and running the installer from the following website.

<https://epson.sn> > **Setup**

Related Information

➔ [“Making Settings for Connecting to the Computer” on page 137](#)

E-10

Solutions:

Check the following.

- Other devices on the network are turned on.
- Network addresses (IP address, subnet mask, and default gateway) are correct if you have set the printer's Obtain IP Address to Manual.

Reset the network address if they are incorrect. You can check the IP address, subnet mask, and default gateway from the **Network Status** part on the network connection report.

Related Information

➔ [“Assigning the IP Address” on page 44](#)

E-11

Solutions:

Check the following.

- The default gateway address is correct if you set the printer's TCP/IP Setup setting to Manual.
- The device that is set as the default gateway is turned on.

Set the correct default gateway address. You can check the default gateway address from the **Network Status** part on the network connection report.

Related Information

➔ [“Assigning the IP Address” on page 44](#)

E-12

Solutions:

Check the following.

- Other devices on the network are turned on.
- The network addresses (IP address, subnet mask, and default gateway) are correct if you are entering them manually.
- The network addresses for other devices (subnet mask and default gateway) are the same.
- The IP address does not conflict with other devices.

If still does not connect your printer and network devices after confirming the above, try the following.

- Turn off the wireless router. Wait for about 10 seconds, and then turn it on.
- Make network settings again using the installer. You can run it from the following website.
<https://epson.sn> > **Setup**
- You can register several passwords on a wireless router that uses WEP security type. If several passwords are registered, check if the first registered password is set on the printer.

Related Information

- ➔ [“Assigning the IP Address” on page 44](#)
- ➔ [“Making Settings for Connecting to the Computer” on page 137](#)

E-13

Solutions:

Check the following.

- Network devices such as a wireless router, hub, and router are turned on.
- The TCP/IP Setup for network devices has not been set up manually. (If the printer's TCP/IP Setup is set automatically while the TCP/IP Setup for other network devices is performed manually, the printer's network may differ from the network for other devices.)

If it still does not work after checking the above, try the following.

- Turn off the wireless router. Wait for about 10 seconds, and then turn it on.
- Make network settings on the computer that is on the same network as the printer using the installer. You can run it from the following website.
<https://epson.sn> > **Setup**
- You can register several passwords on a wireless router that uses the WEP security type. If several passwords are registered, check if the first registered password is set on the printer.

Related Information

- ➔ [“Assigning the IP Address” on page 44](#)
- ➔ [“Making Settings for Connecting to the Computer” on page 137](#)

Message on the Network Environment

Message	Solution
The Wi-Fi environment needs to be improved. Turn the wireless router off and then turn it on. If the connection does not improve, see the documentation for the wireless router.	After moving the printer closer to the wireless router and removing any obstacles between them, turn off the wireless router. Wait for about 10 seconds, and then turn it on. If it still does not connect, see the documentation supplied with the wireless router.
*No more devices can be connected. Disconnect one of the connected devices if you want to add another one.	Computer and smart devices that can be connected simultaneously are connected in full in the Wi-Fi Direct (Simple AP) connection. To add another computer or smart device, disconnect one of the connected devices or connect it to the other network first. You can confirm the number of wireless devices which can be connected simultaneously and the number of connected devices by checking the network status sheet or the printer's control panel.
The same SSID as Wi-Fi Direct exists in the environment. Change the Wi-Fi Direct SSID if you cannot connect a smart device to the printer.	On the printer's control panel, go to Wi-Fi Direct Setup screen and select the menu to change the setting. You can change the network name following after DIRECT-XX-. Enter within 22 characters.

Related Information

➔ ["Print Status Sheet:" on page 192](#)

Preparing and Setting Up the Printer According to Use

Setting Available Optional Items

To use an optional paper source when printing from a computer, you need to make settings on the printer driver.

Setting Available Optional Items - Windows

Note:

Log on to your computer as an administrator.

1. Open the **Optional Settings** tab from the printer properties.

- Windows 11

Click on the start button, and then select **All apps > Windows Tools > Control Panel > View devices and printers in Hardware and Sound**. Right-click on your printer, or press and hold it, select **Printer properties**, and then click the **Optional Settings** tab.

- Windows 10/Windows Server 2022/Windows Server 2019/Windows Server 2016

Click on the start button, and then select **Windows System > Control Panel > View devices and printers in Hardware and Sound**. Right-click on your printer, or press and hold it, select **Printer properties**, and then click the **Optional Settings** tab.

- ❑ Windows 8.1/Windows 8/Windows Server 2012 R2/Windows Server 2012

Select **Desktop > Settings > Control Panel > View devices and printers** in **Hardware and Sound**. Right-click on your printer, or press and hold it, select **Printer properties**, and then click the **Optional Settings** tab.

- ❑ Windows 7/Windows Server 2008 R2

Click the start button, and select **Control Panel > Hardware and Sound > Scanner and Cameras**, and then check if the printer is displayed. Right-click on your printer, select **Printer properties**, and then click the **Optional Settings**.

- ❑ Windows Vista/Windows Server 2008

Click the start button, and then select **Control Panel > Printers** in **Hardware and Sound**. Right-click on your printer, select **Property**, and then click **Optional Settings**.

- ❑ Windows XP/Windows Server 2003 R2/Windows Server 2003

Click the start button, and select **Control Panel > Printers and Other Hardware > Scanner and Cameras**, and then check if the printer is displayed.

2. Select **Acquire from Printer**, and then click **Get**.

3. Click **OK**.

Setting Available Optional Items - Windows PostScript

Note:

Log on to your computer as an administrator.

1. Open the **Optional Settings** tab from the printer properties.

- ❑ Windows 11

Click on the start button, and then select **All apps > Windows Tools > Control Panel > View devices and printers** in **Hardware and Sound**. Right-click on your printer, or press and hold it and then select **Printer properties**. On the **Device Settings** tab.

- ❑ Windows 10//Windows Server 2022/Windows Server 2019/Windows Server 2016

Click on the start button, and then select **Windows System > Control Panel > View devices and printers** in **Hardware and Sound**. Right-click on your printer, or press and hold it and then select **Printer properties**, and then click the **Device Settings** tab.

- ❑ Windows 8.1/Windows 8/Windows Server 2012 R2/Windows Server 2012

Select **Desktop > Settings > Control Panel > View devices and printers** in **Hardware and Sound**. Right-click on your printer, or press and hold it and then select **Printer properties**, and then click the **Device Settings** tab.

- ❑ Windows 7/Windows Server 2008 R2

Click the start button, and select **Control Panel > View devices and printers** in **Hardware and Sound**. Right-click on your printer and select **Printer properties**, and then click the **Device Settings** tab.

- ❑ Windows Vista/Windows Server 2008

Click the start button, and select **Control Panel > Printers** in **Hardware and Sound**. Right-click on your printer and select **Properties**, and then click the **Device Settings** tab.

- ❑ Windows XP/Windows Server 2003 R2/Windows Server 2003

Click the start button, and select **Control Panel > Printers and Other Hardware > Printers and Faxes**. Right-click on your printer and select **Properties**, and then click the **Device Settings** tab.

2. Select the optional device in the **Installable Options** setting.
3. Click **OK**.

Setting Available Optional Items - Mac OS

1. Select **System Preferences** from the Apple menu > **Printers & Scanners** (or **Print & Scan, Print & Fax**), and then select the printer. Click **Options & Supplies** > **Options** (or **Driver**).
2. Make settings according to the type of optional unit.
3. Click **OK**.

Setting Available Optional Items - Mac OSPostScript

1. Select **System Preferences** from the Apple menu > **Printers & Scanners** (or **Print & Scan, Print & Fax**), and then select the printer. Click **Options & Supplies** > **Options** (or **Driver**).
2. Make settings according to the type of optional unit.
3. Click **OK**.

Preparing to Send an E-mail

Configuring a Mail Server

Set the mail server from Web Config.

Check below before setting up.

- The printer is connected to the network that can access the mail server.
- Email setting information of the computer that uses the same mail server as the printer.

Note:

When you use the mail server on the Internet, confirm the setting information from the provider or website.

1. Enter the printer's IP address into a browser to access Web Config.
Enter the printer's IP address from a computer that is connected to the same network as the printer.
You can check the IP address of the printer from the following menu.
Settings > General Settings > Network Settings > Network Status > Wired LAN/Wi-Fi Status
2. Enter the administrator password to log in as an administrator.
3. Select in the following order.
Network tab > **Email Server** > **Basic**
4. Enter a value for each item.

5. Select **OK**.

The settings you have selected are displayed.

Mail Server Setting Items

Items	Settings and Explanation	
Authentication Method	Specify the authentication method for the printer to access the mail server.	
	Off	Set when the mail server does not need authentication.
	SMTP AUTH	Authenticates on the SMTP server (outgoing mail server) when sending the email. The mail server needs to support SMTP authentication.
	POP before SMTP	Authenticates on the POP3 server (receiving mail server) before sending the email. When you select this item, set the POP3 server.
Authenticated Account	<p>If you select SMTP AUTH or POP before SMTP as the Authentication Method, enter the authenticated account name between 0 and 255 characters in ASCII (0x20-0x7E).</p> <p>When you select SMTP AUTH, enter the SMTP server account. When you select POP before SMTP, enter the POP3 server account.</p>	
Authenticated Password	<p>If you select SMTP AUTH or POP before SMTP as the Authentication Method, enter the authenticated password between 0 and 20 characters in ASCII (0x20-0x7E).</p> <p>When you select SMTP AUTH, enter the authenticated account for the SMTP server. When you select POP before SMTP, enter the authenticated account for the POP3 server.</p>	
Sender's Email Address	<p>Enter the sender's email address such as the email address of the system administrator. This is used when authenticating, so enter a valid email address that is registered to the mail server.</p> <p>Enter between 0 and 255 characters in ASCII (0x20-0x7E) except for : () < > [] ; ¥. A period "." cannot be the first character.</p>	
SMTP Server Address	Enter between 0 and 255 characters using A-Z a-z 0-9 . - . You can use IPv4 or FQDN format.	
SMTP Server Port Number	Enter a number between 1 and 65535.	
Secure Connection	Select the encryption method of the communication to the mail server.	
	None	If you select POP before SMTP in Authentication Method , the connection is not encrypted.
	SSL/TLS	This is available when Authentication Method is set to Off or SMTP AUTH . Communication is encrypted from the start.
STARTTLS	This is available when Authentication Method is set to Off or SMTP AUTH . Communication is not encrypted from the start, but depending on the network environment, whether the communication is encrypted or not is changed.	
Certificate Validation	<p>The certificate is validated when this is enabled. We recommend this is set to Enable. To set up, you need to import the CA Certificate to the printer.</p> <p>If an error message is displayed saying that the certificate is untrusted, see the following.</p> <p>"The Date and Time Are Incorrect" on page 169</p> <p>"The Root Certificate Needs to be Updated" on page 169</p>	

Items	Settings and Explanation
POP3 Server Address	If you select POP before SMTP as the Authentication Method , enter the POP3 server address between 0 and 255 characters using A-Z a-z 0-9 . - . You can use IPv4 or FQDN format.
POP3 Server Port Number	If you select POP before SMTP as the Authentication Method , enter a number between 1 and 65535.

Checking a Mail Server Connection

You can check the connection to the mail server by performing the connection check.

1. Enter the IP address of the printer in the browser and start Web Config.
Enter the printer's IP address from a computer that is connected to the same network as the printer.
2. Enter the administrator password to log in as an administrator.
3. Select in the following order.
Network tab > **Email Server** > **Connection Test**
4. Select **Start**.
The connection test to the mail server is started. After the test, the check report is displayed.

Mail Server Connection Test References

Messages	Cause
Connection test was successful.	This message appears when the connection with the server is successful.
SMTP server communication error. Check the following. - Network Settings	This message appears when <input type="checkbox"/> The printer is not connected to a network <input type="checkbox"/> SMTP server is down <input type="checkbox"/> Network connection is disconnected while communicating <input type="checkbox"/> Received incomplete data
POP3 server communication error. Check the following. - Network Settings	This message appears when <input type="checkbox"/> The printer is not connected to a network <input type="checkbox"/> POP3 server is down <input type="checkbox"/> Network connection is disconnected while communicating <input type="checkbox"/> Received incomplete data
An error occurred while connecting to SMTP server. Check the followings. - SMTP Server Address - DNS Server	This message appears when <input type="checkbox"/> Connecting to a DNS server failed <input type="checkbox"/> Name resolution for an SMTP server failed
An error occurred while connecting to POP3 server. Check the followings. - POP3 Server Address - DNS Server	This message appears when <input type="checkbox"/> Connecting to a DNS server failed <input type="checkbox"/> Name resolution for a POP3 server failed

Messages	Cause
SMTP server authentication error. Check the followings. - Authentication Method - Authenticated Account - Authenticated Password	This message appears when SMTP server authentication failed.
POP3 server authentication error. Check the followings. - Authentication Method - Authenticated Account - Authenticated Password	This message appears when POP3 server authentication failed.
Unsupported communication method. Check the followings. - SMTP Server Address - SMTP Server Port Number	This message appears when you try to communicate with unsupported protocols.
Connection to SMTP server failed. Change Secure Connection to None.	This message appears when an SMTP mismatch occurs between a server and a client, or when the server does not support SMTP secure connection (SSL connection).
Connection to SMTP server failed. Change Secure Connection to SSL/TLS.	This message appears when an SMTP mismatch occurs between a server and a client, or when the server requests to use an SSL/TLS connection for an SMTP secure connection.
Connection to SMTP server failed. Change Secure Connection to STARTTLS.	This message appears when an SMTP mismatch occurs between a server and a client, or when the server requests to use a STARTTLS connection for an SMTP secure connection.
The connection is untrusted. Check the following. - Date and Time	This message appears when the printer's date and time setting is incorrect or the certificate has expired.
The connection is untrusted. Check the following. - CA Certificate	This message appears when the printer does not have a root certificate corresponding to the server or a CA Certificate has not been imported.
The connection is not secured.	This message appears when the obtained certificate is damaged.
SMTP server authentication failed. Change Authentication Method to SMTP-AUTH.	This message appears when an authentication method mismatch occurs between a server and a client. The server supports SMTP AUTH.
SMTP server authentication failed. Change Authentication Method to POP before SMTP.	This message appears when an authentication method mismatch occurs between a server and a client. The server does not support SMTP AUTH.
Sender's Email Address is incorrect. Change to the email address for your email service.	This message appears when the specified sender's Email address is wrong.
Cannot access the printer until processing is complete.	This message appears when the printer is busy.

Initial Settings for Printing

Set the print settings, such as paper size or printing error.

Using the Print Functions

Enable to use the print function through the network.

To use the printer on the network, you need to set the port for network connection on the computer as well as the printer's network connection.

Printer Connection Types

The following two methods are available for the printer's network connection.

- Peer to peer connection (direct printing)
- Server / client connection (printer sharing using the Windows server)

Peer to Peer Connection Settings

This is the connection to connect the printer on the network and the computer directly. Only a network-capable model can be connected.

Connection method:

Connect the printer to the network directly via hub or access point.

Printer driver:

Install the printer driver on each client computer.

When using EpsonNet SetupManager, you can provide the driver's package that includes the printer settings.

Features:

- The print job starts immediately because the print job is sent to the printer directly.
- You can print as long as the printer runs.

Server / Client Connection Settings

This is the connection that the server computer shares with the printer. To prohibit the connection without going through the server computer, you can enhance the security.

When using USB, the printer without the network function can be also shared.

Connection method:

Connect the printer to the network via LAN switch or access point.

You can also connect the printer to the server directly by USB cable.

Printer driver:

Install the printer driver on the Windows server depending on the OS of the client computers.

By accessing the Windows server and linking the printer, the printer driver is installed on the client computer and can be used.

Features:

- Manage the printer and the printer driver in batch.
- Depending on the server spec, it may take time to start the print job because all print jobs go through the print server.

You cannot print when the Windows server is turned off.

Print Settings for Peer to Peer Connection

For peer to peer connection (direct printing), a printer and a client computer have a one-to-one relationship. The printer driver must be installed on each client computer.

Print Settings for Server / Client Connection

Enable to print from the printer that is connected as the server / client connection.

For the server / client connection, set up the print server first, and then share the printer on the network.

When using the USB cable to connect to the server, also set the print server first, and then share the printer on the network.

Setting Up the Network Ports

Create the print queue for network printing on the print server by using standard TCP/IP, and then set the network port.

This example is when using Windows Server 2012 R2.

1. Open the devices and printers screen.
Desktop > Settings > Control Panel > Hardware and Sound or Hardware > Devices and Printers.
2. Add a printer.
Click **Add printer**, and then select **The printer that I want isn't listed**.
3. Add a local printer.
Select **Add a local printer or network printer with manual settings**, and then click **Next**.
4. Select **Create a new port**, select **Standard TCP/IP Port** as the Port Type, and then click **Next**.

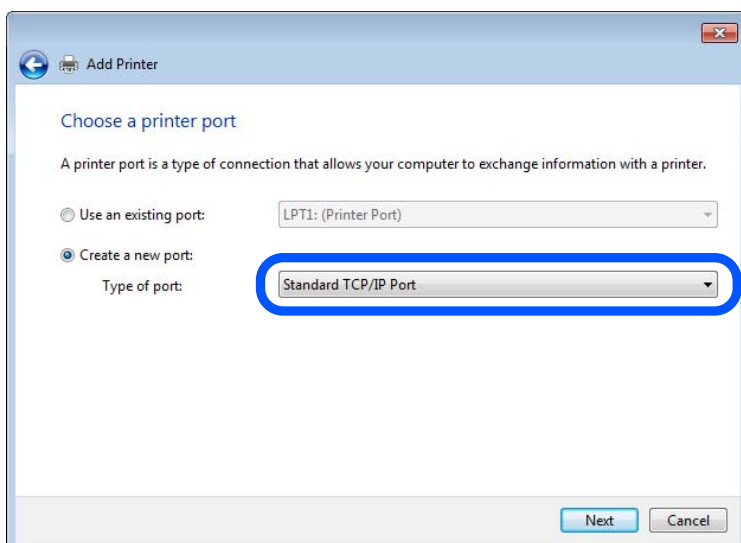

5. Enter the printer's IP address or printer name in **Host Name or IP Address** or **Printer Name or IP Address**, and then click **Next**.

Example:

- Printer name : EPSONA1A2B3C
- IP address : 192.0.2.111

Do not change **Port name**.

Click **Continue** when the **User Account Control** screen is displayed.

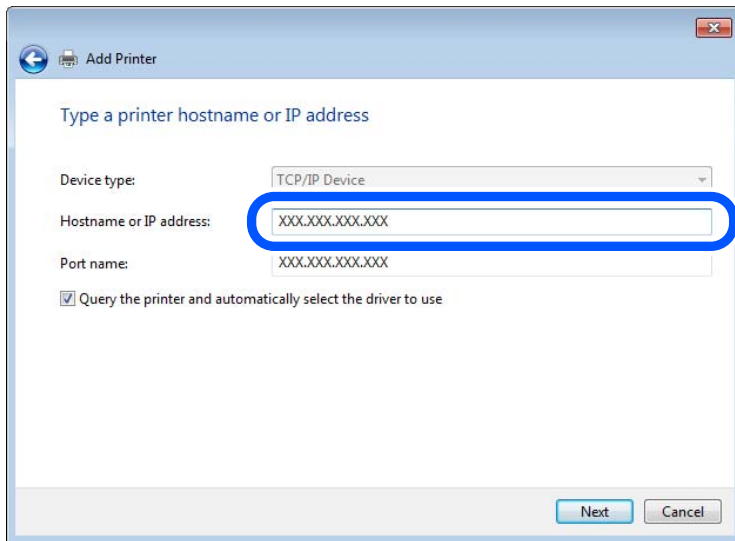

Note:

If you specify the printer name on the network where the name resolution is available, the IP address is tracked even if printer's IP address has been changed by DHCP. You can confirm the printer name from the network status screen on the printer's control panel or network status sheet.

6. Set the printer driver.
 - If the printer driver is already installed:
Select **Manufacturer** and **Printers**. Click **Next**.

7. Follow the on-screen instructions.

When using the printer under the server / client connection (printer sharing using the Windows server), make the sharing settings hereafter.

Checking the Port Configuration - Windows

Check if the correct port is set for the print queue.

1. Open the devices and printers screen.
Desktop > Settings > Control Panel > Hardware and Sound or **Hardware > Devices and Printers**.
2. Open the printer properties screen.
Right-click the printer icon, and then click **Printer properties**.
3. Click the **Ports** tab, select **Standard TCP/IP Port**, and then click **Configure Port**.

4. Check the port configuration.

For RAW

Check that **Raw** is selected in **Protocol**, and then click **OK**.

For LPR

Check that **LPR** is selected in **Protocol**. Enter "PASSTHRU" in **Queue name** from **LPR Settings**. Select **LPR Byte Counting Enabled**, and then click **OK**.

Sharing the Printer (Windows only)

When using the printer under the server / client connection (printer sharing using the Windows server), set up the printer sharing from the print server.

1. Select **Control Panel > View devices and printers** on the print server.
2. Right-click the printer icon (print queue) that you want to share with, and then select **Printer Properties > Sharing** tab.

3. Select **Share this printer** and then enter to **Share name**.

For Windows Server 2012, click **Change Sharing Options** and then configure the settings.

Installing Additional Drivers (Windows only)

If the Windows versions for a server and clients are different, it is recommended to install additional drivers to the print server.

1. Select **Control Panel > View devices and printers** on the print server.
2. Right-click the printer icon that you want to share with the clients, and then click **Printer Properties > Sharing** tab.

3. Click **Additional Drivers**.

For Windows Server 2012, click **Change Sharing Options** and then configure the settings.

4. Select versions of Windows for clients, and then click **OK**.

5. Select the information file for the printer driver (*.inf) and then install the driver.

Using the Shared Printer – Windows

The administrator needs to inform the clients of the computer name assigned to the print server and how to add it to their computers. If the additional driver(s) have not been configured yet, inform the clients how to use **Devices and Printers** to add the shared printer.

If additional driver(s) have already been configured on the print server, follow these steps:

1. Select the name assigned to the print server in **Windows Explorer**.
2. Double-click the printer that you want to use.

Setting the Paper Source

Set the size and type of paper to be loaded in each paper source.

1. Enter the printer's IP address into a browser to access Web Config.

Enter the printer's IP address from a computer that is connected to the same network as the printer.

You can check the IP address of the printer from the following menu.

Settings > General Settings > Network Settings > Network Status > Wired LAN/Wi-Fi Status

2. Enter the administrator password to log in as an administrator.

3. Select in the following order.

Print tab > Paper Source Settings

4. Set each item.

The displayed items may vary by the situation.

- Paper source name**

Display the target paper source name, such as **Paper Tray**, **Cassette 1**.

- Paper Size**

Select the paper size you want to set from the pull-down menu.

- Unit**

Select the unit of the user-defined size. You can select it when **User defined** is selected on **Paper Size**.

- Width**

Set the horizontal length of the user-defined size.

The range you can enter here depends on the paper source, which is indicated on the side of **Width**.

When you select **mm** in **Unit**, you can enter up to one decimal place.

When you select **inch** in **Unit**, you can enter up to two decimal places.

- Height**

Set the vertical length of the user-defined size.

The range you can enter here depends on the paper source, which is indicated on the side of **Height**.

When you select **mm** in **Unit**, you can enter up to one decimal place.

When you select **inch** in **Unit**, you can enter up to two decimal places.

- Paper Type**

Select the paper type you want to set from the pull-down menu.

5. Check the settings, and then click **OK**.

Setting the Interface

Set the timeout of the print jobs or printing language assigned to each interface.

This item is displayed on the PCL or PostScript compatible printer.

1. Enter the printer's IP address into a browser to access Web Config.

Enter the printer's IP address from a computer that is connected to the same network as the printer.

You can check the IP address of the printer from the following menu.

Settings > General Settings > Network Settings > Network Status > Wired LAN/Wi-Fi Status

2. Enter the administrator password to log in as an administrator.

3. Select in the following order.

Print tab > Interface Settings

4. Set each item.

Timeout Settings

Set the timeout of the print jobs sent directly via USB.

You can set between 5 and 300 seconds by the second.

When you do not want to timeout, enter 0.

Printing Language

Select the printing language for each USB interface and network interface.

When you select **Auto**, the printing language is automatically detected by the print jobs being sent.

5. Check the settings, and then click **OK**.

Setting Errors

Set the displaying error for the device.

1. Enter the printer's IP address into a browser to access Web Config.

Enter the printer's IP address from a computer that is connected to the same network as the printer.

You can check the IP address of the printer from the following menu.

Settings > General Settings > Network Settings > Network Status > Wired LAN/Wi-Fi Status

2. Enter the administrator password to log in as an administrator.

3. Select in the following order.

Print tab > Error Settings

4. Set each item.

Paper Size Notice

Set whether to display an error on the control panel when the paper size of the specified paper source is different from the paper size of the print data.

Paper Type Notice

Set whether to display an error on the control panel when the paper type of the specified paper source is different from the paper type of the print data.

Auto Error Solver

Set whether to automatically cancel the error if there is no operation on the control panel for 5 seconds after displaying the error.

5. Check the settings, and then click **OK**.

Setting Universal Print

Set when you print from external devices without using the printer driver.

Some items are not displayed depending on the printing language of your printer.

1. Enter the printer's IP address into a browser to access Web Config.
 Enter the printer's IP address from a computer that is connected to the same network as the printer.
 You can check the IP address of the printer from the following menu.
Settings > General Settings > Network Settings > Network Status > Wired LAN/Wi-Fi Status
2. Enter the administrator password to log in as an administrator.
3. Select in the following order.
Print tab > Universal Print Settings
4. Set each item.
5. Check the settings, and then click **OK**.

Basic

Items	Explanation
Top Offset(-30.0-30.0mm)	Sets the vertical position of the paper on which printing starts.
Left Offset(-30.0-30.0mm)	Sets the horizontal position of the paper on which printing starts.
Top Offset in Back(-30.0-30.0mm)	Sets the vertical position of the paper on which the printing of the back side of the paper starts in duplex printing.
Left Offset in Back(-30.0-30.0mm)	Sets the horizontal position of the paper on which the printing of the back side of the paper starts in duplex printing.
Check Paper Width	Set whether to check paper width when printing.
Skip Blank Page	If there is a blank page in the print data, set not to print a blank page.

PDL Print Configuration

You can specify settings for PCL or PostScript printing.

This item is displayed on a PCL or PostScript compatible printer.

Common Settings

Items	Explanation
Paper Size	Select the paper size on which you want to print.
Paper Type	Select the type of paper on which you print.
Orientation	Select the orientation you want to use to print.

Items	Explanation
Quality	Select the print quality you want to use for printing.
Ink Save Mode	Set whether to print with reduced ink consumption.
Print Order	Select to print from the top or the last page.
Number of Copies(1-999)	Set the number of copies you want to print.
Binding Margin	Select the binding position.
Auto Paper Ejection	Select whether to eject paper automatically when timeout is occurred during receiving a print job.
2-Sided Printing	Set whether printing 2-sided.

PCL Menu

Items	Explanation
Font Source	Select whether to use the font installed on the printer or download it.
Font Number	Specify the font number you want to use.
Pitch(0.44-99.99cpi)	If the font to use is scalable and fixed-pitch font, specify the font size in pitch.
Height(4.00-999.75pt)	If the font to use is scalable and proportional font, specify the font size in points.
Symbol Set	Select the symbol set of the font you want to use.
Form(5-128lines)	Specify the number of lines per page.
CR Function	Select the operation for the CR code (return).
LF Function	Select the operation for the LF code (new line), FF code (new page).
Paper Source Assign	Specify paper feeder assignment for PCL paper feed command.

PS Menu

Items	Explanation
Error Sheet	Set whether to print an error sheet when PS3 printing error occurs.
Coloration	Set as color printing or monochrome printing. You can only select monochrome for this printer.
Binary	Set whether to accept the binary data or not.
PDF Page Size	Set the paper size for PDF printing.

Setting Up Universal Print (Microsoft)

You can setup your printer to use Universal Print. To use this function, you need to be using Microsoft 365 and Azure Active Directory service.

1. Enter the printer's IP address into a browser to access Web Config.
 Enter the printer's IP address from a computer that is connected to the same network as the printer.
 You can check the IP address of the printer from the following menu.
Settings > General Settings > Network Settings > Network Status > Wired LAN/Wi-Fi Status
2. Enter the administrator password to log in as an administrator.
3. Select in the following order.
Network tab > Universal Print
4. Click **Register**.
5. Read the message displayed, and then click the link.
6. Follow the on-screen instructions to register the printer.
 If the registration status displays **Registered** on the Web Config screen after registration, then setup is complete.

Note:

For details on operating the Azure Active Directory, such as how to use Universal Print, see the Microsoft web site.

Setting Up AirPrint

Set when using AirPrint printing.

Access Web Config and select the **Network** tab > **AirPrint Setup**.

Items	Explanation
Bonjour Service Name	Enter the Bonjour service name between 1 and 41 characters in ASCII (0x20-0x7E).
Bonjour Location	Enter location information such as the printer's placement within 127 bytes or less in Unicode (UTF-8).
Geolocation Latitude and Longitude (WGS84)	Enter the printer's location information. This entry is optional. Enter values by using WGS-84 datum, which separates latitude and longitude with a comma. You can enter -90 to +90 for the latitude value, and -180 to +180 for the longitude value. You can enter less than a decimal to the sixth place, and you can omit "+".
Top Priority Protocol	Select top priority protocol from IPP and Port9100.
Wide-Area Bonjour	Set whether or not to use Wide-Area Bonjour. If you use it, the printers must be registered on the DNS server to be able to search the printer over the segment.
iBeacon Transmission	Select whether to enable or disable the iBeacon transmission function. When enabled, you can search for the printer from iBeacon-enabled devices.
Require PIN Code when using IPP printing	Select whether or not to require a PIN code when using IPP printing. If you select Yes , IPP print jobs without PIN codes are not saved in the printer.
Enable AirPrint	IPP, Bonjour, AirPrint are enabled, and IPP is established only with secure communication.

Problems when Making Settings

Hints to Solving Problems

Checking the error message

When trouble has occurred, first check whether there are any messages on the printer's control panel or driver screen. If you have the notification email set when the events occur, you can promptly learn the status.

Network connection report

Diagnose the network and the printer status, and then print the result.

You can find the diagnosed error from the printer side.

Checking the communication status

Check the communication status of server computer or client computer by using the command such as ping and ipconfig.

Connection test

For checking the connection between the printer to the mail server, perform the connection test from the printer. Also, check the connection from the client computer to the server to check the communication status.

Initializing the settings

If the settings and communication status show no problem, the problems may be solved by disabling or initializing the network settings of the printer, and then setting up again.

Cannot Access Web Config

■ The IP address is not assigned to the printer.

Solutions

A valid IP address may not be assigned to the printer. Configure the IP address using the printer's control panel. You can confirm the current setting information with a network status sheet or from the printer's control panel.

■ The TLS version is not supported

Solutions

You need to communicate using TLS version 1.2 or later.

Version 1.0 or 1.1 of TLS is initially disabled.

If you want to communicate with TLS Version 1.0 or 1.1, first access Web Config from a device that can communicate with TLS Version 1.2 or later, and then enable TLS Version 1.0 or 1.1.

➔ [“Configuring Basic SSL/TLS Settings” on page 250](#)

■ Web browser does not support the Encryption Strength for SSL/TLS.

Solutions

SSL/TLS has the Encryption Strength. You can open Web Config by using a web browser that supports bulk encryptions as indicated below. Check you are using the a supported browser.

80bit: AES256/AES128/3DES

- 112bit: AES256/AES128/3DES
- 128bit: AES256/AES128
- 192bit: AES256
- 256bit: AES256

■ CA-signed Certificate is expired.

Solutions

If there is a problem with the expiration date of the certificate, "The certificate has expired" is displayed when connecting to Web Config with SSL/TLS communication (https). If the message appears before its expiration date, make sure that the printer's date is configured correctly.

■ The common name of the certificate and the printer do not match.

Solutions

If the common name of the certificate and the printer do not match, the message "The name of the security certificate does not match..." is displayed when accessing Web Config using SSL/TLS communication (https). This happens because the following IP addresses do not match.

- The printer's IP address entered to common name for creating a Self-signed Certificate or CSR
- IP address entered to web browser when running Web Config

For Self-signed Certificate, update the certificate.

For CA-signed Certificate, take the certificate again for the printer.

■ The proxy server setting of local address is not set to web browser.

Solutions

When the printer is set to use a proxy server, configure the web browser not to connect to the local address via the proxy server.

- Windows:

Select **Control Panel > Network and Internet > Internet Options > Connections > LAN settings > Proxy server**, and then configure not to use the proxy server for LAN (local addresses).

- Mac OS:

Select **System Preferences > Network > Advanced > Proxies**, and then register the local address for **Bypass proxy settings for these Hosts & Domains**.

Example:

192.168.1.*: Local address 192.168.1.XXX, subnet mask 255.255.255.0

192.168.*.*: Local address 192.168.XXX.XXX, subnet mask 255.255.0.0

Loading Paper

Paper Handling Precautions.	75
Paper Size and Type Settings.	75
Loading Paper.	77
Loading Various Paper.	77

Paper Handling Precautions

- ❑ Read the instruction sheets supplied with the paper.
- ❑ To achieve high-quality printouts with genuine Epson paper, use the paper in the environment stated on the sheets supplied with the paper.
- ❑ Fan and align the edges of the paper before loading. Do not fan or curl photo paper. Doing so may damage the printable side.

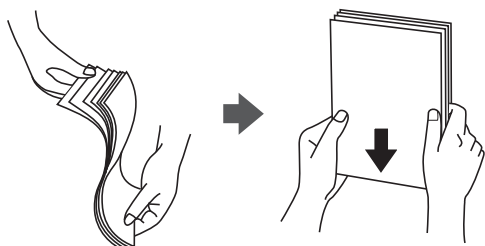

- ❑ If the paper is curled or folded, flatten it or curl it slightly in the opposite direction before loading. Printing on curled or folded paper may cause paper feeding problems and smears on the printouts.

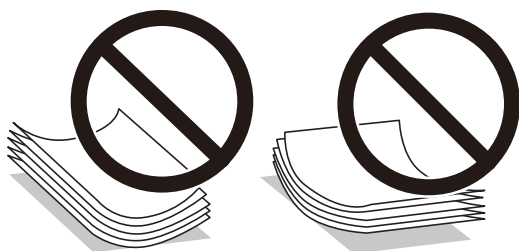

- ❑ Paper feed problems may occur frequently for manual 2-sided printing when printing on one side of pre-printed paper. Reduce the number of sheets to half or less, or load one sheet of paper at a time if paper jams continue.
- ❑ Fan and align the edges of the envelopes before loading. When the stacked envelopes are puffed up with air, press them down to flatten them before loading.



Related Information

- ➔ [“Available Paper and Capacities” on page 173](#)
- ➔ [“Unavailable Paper Types” on page 176](#)

Paper Size and Type Settings

Make sure that you register the paper size and type on the screen displayed when you load paper. The printer informs you when the registered information and print settings differ. This prevents you from wasting paper and

ink by making sure you are not printing on the wrong paper size or printing using poor print quality due to settings that do not match the paper type.

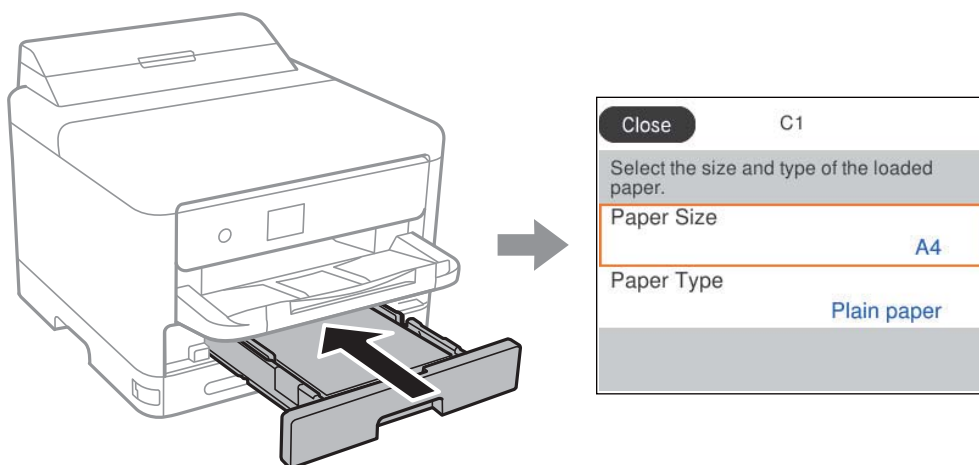

If the paper size and type displayed differ from the loaded paper, select the item you want to change. If the settings match the loaded paper, close the screen.

To select an item, use the ▲ ▼ ◀ ▶ buttons, and then press the OK button.

Note:

If you do not want to display the paper settings screen automatically when you load paper, select the menus on the home screen as described below.

Settings > General Settings > Printer Settings > Paper Source Settings > Paper Setup Auto Display > Off

Related Information

➔ [“Paper Setup Auto Display:” on page 187](#)

List of Paper Type

To obtain optimum printing results, select the paper type that suits the paper.

Media Name	Media Type			
	Control Panel	Printer Driver, Smart device*	PostScript Printer Driver	Epson Universal Printer Driver
Epson Bright White Ink Jet Paper Epson Business Paper	Plain paper	Plain paper	Plain	Plain
Epson Matte Paper-Heavyweight Epson Double-Sided Matte Paper	Matte	Epson Matte	Epson Matte	-
Epson Photo Quality Ink Jet Paper	Photo Quality Ink Jet	Epson Photo Quality Ink Jet	Epson Photo Quality Ink Jet	-

Media Name	Media Type			
	Control Panel	Printer Driver, Smart device*	PostScript Printer Driver	Epson Universal Printer Driver
Thick paper (91 to 160 g/m ²)	Thick paper1	Thick paper1	Thick1	Thick-Paper1
Thick paper (161 to 256 g/m ²)	Thick paper2	Thick paper2	Thick2	Thick-Paper2

* For smart devices, these media types can be selected when printing using Epson Smart Panel.

Loading Paper

You can load paper or envelopes by referring to the animations displayed on the printer's LCD screen.

Select , and then select **How To...** > **Load paper**.

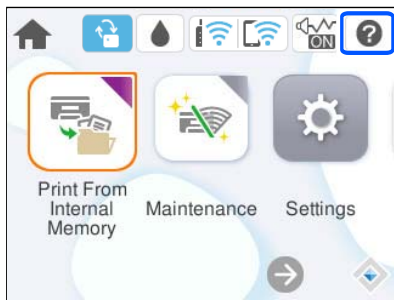

Select the paper type and paper source you want to use to display the animations.

Select **Finish** to close the animation screen.

Loading Various Paper

Loading Pre-punched Paper

Load a single sheet of pre-punched paper in the paper tray.

Paper size: A4, B5, A5, A6, Letter, Legal

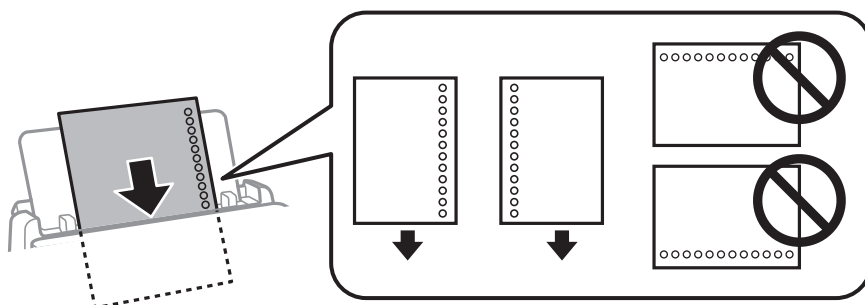

- Adjust the print position of your file to avoid printing over the holes.
- Automatic 2-sided printing is not available for pre-punched paper.

Related Information

- ➔ [“Available Paper and Capacities” on page 173](#)
- ➔ [“Unavailable Paper Types” on page 176](#)

Loading Long Papers

Load long paper in the paper tray by allowing the leading edge of the paper to roll over. Select **User-Defined** as the paper size setting.

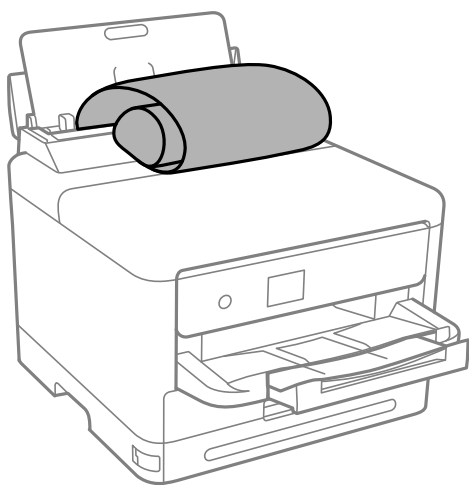

- Make sure the end of the paper is cut perpendicularly. A diagonal cut may cause paper feed problems.
- Long paper cannot be held in the output tray. Prepare a box and so on to make sure that paper does not fall on the floor.
- Do not touch paper that is being fed or ejected. It could injure your hand or cause print quality to decline.

Related Information

- ➔ [“Available Paper and Capacities” on page 173](#)
- ➔ [“Unavailable Paper Types” on page 176](#)

Printing

Printing Documents.	80
Printing on Envelopes.	119
Printing Web Pages.	119
Printing Using a Cloud Service.	120

Printing Documents

Printing from a Computer - Windows

If you cannot change some of the printer driver settings, they may have been restricted by the administrator. Contact your printer administrator for assistance.

Printing Using Easy Settings

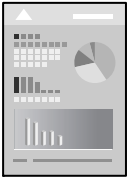

Note:

Operations may differ depending on the application. See the application's help for details.

1. Load paper in the printer.
 [“Loading Paper” on page 77](#)
2. Open the file you want to print.
3. Select **Print** or **Print Setup** from the **File** menu.
4. Select your printer.

5. Select **Preferences** or **Properties** to access the printer driver window.

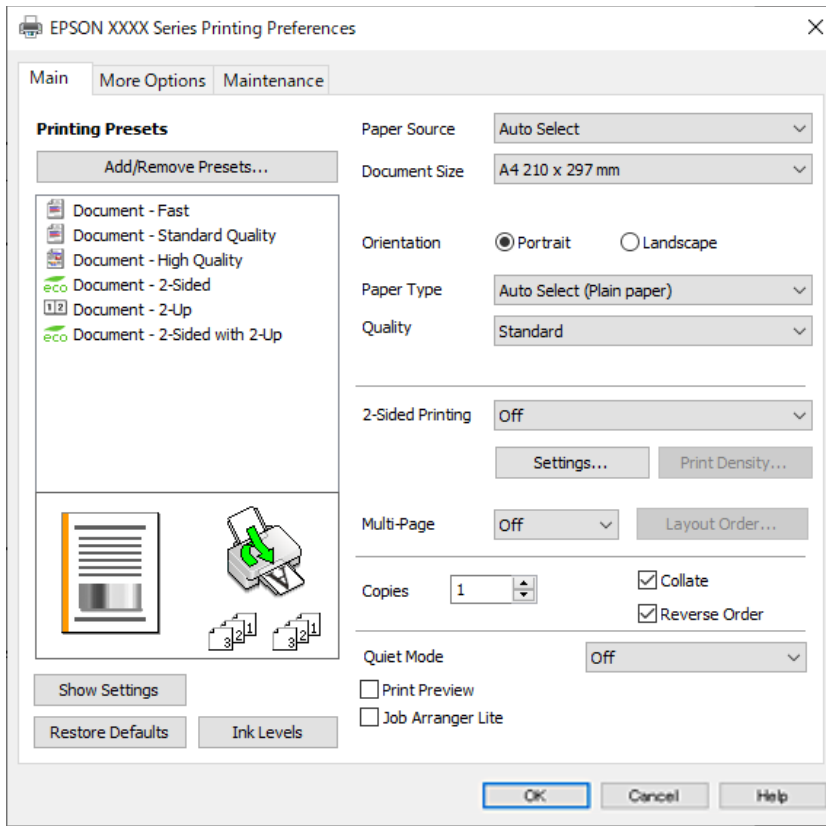

6. Change the settings as necessary.

See the menu options for the printer driver for details.

Note:

- You can also see the online help for explanations of the setting items. Right-clicking an item displays **Help**.
- When you select **Print Preview**, you can see a preview of your document before printing.

7. Click **OK** to close the printer driver window.

8. Click **Print**.

Note:

- When you select **Print Preview**, a preview window is displayed. To change the settings, click **Cancel**, and then repeat the procedure from step 3.
- If you want to cancel printing, on your computer right-click on your printer in **Devices and Printers**, **Printer**, or in **Printers and Faxes**. Click **See what's printing**, right-click on the job you want to cancel, and then select **Cancel**. However, you cannot cancel a print job from the computer once it has been completely sent to the printer. In this case, cancel the print job by using the printer's control panel.

Related Information

- ➔ [“Available Paper and Capacities” on page 173](#)
- ➔ [“List of Paper Type” on page 76](#)
- ➔ [“Menu Options for the Printer Driver” on page 82](#)

Menu Options for the Printer Driver

Open the print window in an application, select the printer, and then access the printer driver window.

Note:

Menus vary depending on the option you selected.

Main Tab

Printing Presets:

Add/Remove Presets:

You can add or remove your own presets for frequently used print settings. Select the preset you want to use from the list.

Show Settings/Hide Settings:

Displays a list of items currently set on the **Main** and **More Options** tabs. You can show or hide the current setting list screen.

Restore Defaults:

Return all settings to their factory default values. The settings on the **More Options** tab are also reset to their defaults.

Ink Levels:

Displays the approximate ink level.

Paper Source:

Select the paper source from which the paper is fed. Select **Auto Select** to automatically select the paper source selected in the print settings on the printer.

Document Size:

Select the paper size on which you want to print. If you select **User-Defined**, enter the paper width and height, and then register the size.

Orientation:

Select the orientation you want to use to print.

Paper Type:

Select the type of paper on which you print.

Quality:

Select the print quality you want to use for printing. Available settings depend on the paper type you select. Selecting **High** provides higher quality printing, but the printing speed may be slower.

2-Sided Printing:

Allows you to perform 2-sided printing.

Settings:

You can specify the binding edge and the binding margins. When printing multi-page documents, you can select to print starting from either the front or the back side of the page.

Print Density:

Select the document type to adjust the print density. If the appropriate print density is selected, you can prevent images from bleeding through to the reverse side. Select **User-Defined** to adjust the print density manually.

Multi-Page:

Allows you to print several pages on one sheet or perform poster printing. Click **Layout Order** to specify the order in which pages are printed.

Copies:

Set the number of copies you want to print.

Collate:

Prints multi-page documents collated in order and sorted into sets.

Reverse Order:

Allows you to print from the last page so that the pages are stacked in the correct order after printing.

Quiet Mode:

Reduces the noise the printer makes. However, enabling this may reduce print speed.

Print Preview:

Displays a preview of your document before printing.

Job Arranger Lite:

Job Arranger Lite allows you to combine several files created by different applications and print them as a single print job.

More Options Tab

Printing Presets:

Add/Remove Presets:

You can add or remove your own presets for frequently used print settings. Select the preset you want to use from the list.

Show Settings/Hide Settings:

Displays a list of items currently set on the **Main** and **More Options** tabs. You can show or hide the current setting list screen.

Restore Defaults:

Return all settings to their factory default values. The settings on the **Main** tab are also reset to their defaults.

Document Size:

Select the paper size on which you want to print.

Output Paper:

Select the paper size on which you want to print. If the **Document Size** differs from the **Output Paper, Reduce/Enlarge Document** is selected automatically. You do not have to select it when printing without reducing or enlarging the size of a document.

Reduce/Enlarge Document:

Allows you to reduce or enlarge the size of a document.

Fit to Page:

Automatically reduce or enlarge the document to fit to the paper size selected in **Output Paper**.

Zoom to:

Prints with a specific percentage.

Center:

Prints images in the center of the paper.

Tone Correction:

Automatic:

Adjusts the tone of images automatically.

Custom:

Allows you to perform manual tone correction. Click **Advanced** for further settings.

Image Options:

Enables print quality options such as Emphasize Text. You can also thicken thin lines to make them visible on the printouts.

Watermark Features:

Allows you to make settings for anti-copy patterns, watermarks, or headers and footers.

Add/Delete:

Allows you to add or remove any anti-copy patterns or watermarks that you want to use.

Settings:

Allows you to set the printing method for anti-copy patterns or watermarks.

Header/Footer:

You can print information such as a user name and printing date in headers or footers. You can then set font, size, or style.

Confidential Job:

Password-protect confidential documents when printing. If you use this feature, the print data is stored in the printer and can only be printed after the password has been entered using the printer's control panel. Click **Settings** to change the settings.

Additional Settings:

Rotate 180°:

Rotates pages 180 degrees before printing. Select this item when printing on paper such as envelopes that are loaded in fixed direction in the printer.

Bidirectional Printing:

Prints when the print head moves in both directions. The print speed is faster, but the quality may decline.

Mirror Image:

Inverts the image so that it prints as it would appear in a mirror.

Maintenance Tab

Print Head Nozzle Check:

Prints a nozzle check pattern to check if the print head nozzles are clogged.

Print Head Cleaning:

Cleans the clogged nozzles in the print head. Because this feature uses some ink, clean the print head only if the nozzle is clogged. Print a nozzle check pattern and then select **Clean**.

Job Arranger Lite:

Opens the Job Arranger Lite window. Here you can open and edit previously saved data.

EPSON Status Monitor 3:

Opens the EPSON Status Monitor 3 window. Here you can confirm the status of the printer and the consumables.

Monitoring Preferences:

Allows you to make settings for items on the EPSON Status Monitor 3 window.

Extended Settings:

Allows you to make a variety of settings. Right-click each item to view the Help for more details.

Print Queue:

Displays the jobs waiting to be printed. You can check, pause, or resume print jobs.

Printer and Option Information:

You can register user accounts. If access control is set on the printer, you must register your account.

Language:

Changes the language to be used on the printer driver window. To apply the settings, close the printer driver, and then open it again.

Software Update:

Starts EPSON Software Updater to check for the latest version of applications on the Internet.

Technical Support:

If the manual is installed on your computer, the manual is displayed. If it is not installed, you can connect to the Epson Web site to check the manual and available technical support.

Adding Printing Presets for Easy Printing

If you create your own preset of frequently used print settings on the printer driver, you can print easily by selecting the preset from the list.

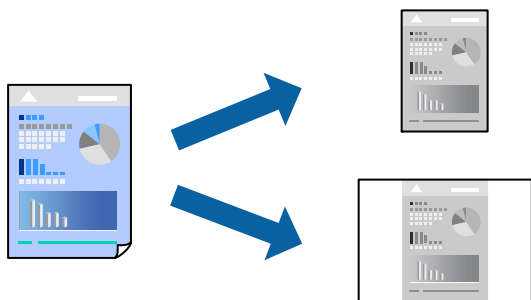

1. On the printer driver's **Main** or **More Options** tab, set each item (such as **Document Size** and **Paper Type**).
2. Click **Add/Remove Presets** in **Printing Presets**.
3. Enter a **Name** and, if necessary, enter a comment.
4. Click **Save**.

Note:

To delete an added preset, click **Add/Remove Presets**, select the preset name you want to delete from the list, and then delete it.

[“Main Tab” on page 82](#)

[“More Options Tab” on page 83](#)

5. Click **Print**.

The next time you want to print using the same settings, select the registered setting name from **Printing Presets**, and click **OK**.

Related Information

- ➔ [“Loading Paper” on page 77](#)
- ➔ [“Printing Using Easy Settings” on page 80](#)

Printing on 2-Sides

You can use either of the following methods to print on both sides of the paper.

- Automatic 2-sided printing

Manual 2-sided printing

When the printer has finished printing the first side, flip the paper over to print on the other side.

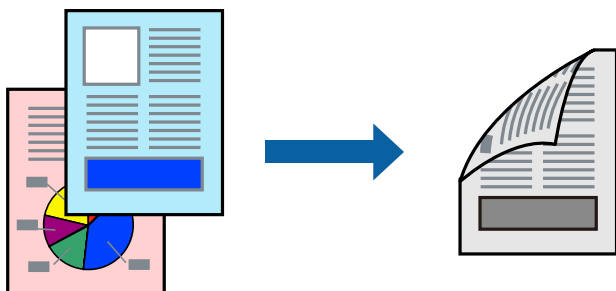

Note:

- If you do not use paper that is suitable for 2-sided printing, the print quality may decline and paper jams may occur.
[“Paper for 2-Sided Printing” on page 175](#)
- Depending on the paper and the data, ink may bleed through to the other side of the paper.
- You cannot perform manual 2-sided printing unless **EPSON Status Monitor 3** is enabled. If **EPSON Status Monitor 3** is disabled, access the printer driver window, click **Extended Settings** on the **Maintenance** tab, and then select **Enable EPSON Status Monitor 3**.
- However, manual 2-sided printing may not be available when the printer is accessed over a network or is used as a shared printer.

1. On the printer driver's **Main** tab, select the method of **2-Sided Printing**.
2. Click **Settings**, make the appropriate settings, and then click **OK**.
3. Click **Print Density**, make the appropriate settings, and then click **OK**.

When setting **Print Density**, you can adjust print density according to the document type.

Note:

- This setting is not available when you select manual 2-sided printing.
- Printing may be slow depending on the combination of options selected for **Select Document Type** in the **Print Density Adjustment** window and for **Quality** on the **Main** tab.

4. Set the other items on the **Main** and **More Options** tabs as necessary, and then click **OK**.

[“Main Tab” on page 82](#)

[“More Options Tab” on page 83](#)

5. Click **Print**.

For manual 2-sided printing, when the first side has finished printing, a pop-up window is displayed on the computer. Follow the on-screen instructions.

Related Information

- ➔ [“Available Paper and Capacities” on page 173](#)
- ➔ [“Loading Paper” on page 77](#)
- ➔ [“Printing Using Easy Settings” on page 80](#)

Printing a Booklet

You can also print a booklet that can be created by re-ordering the pages and folding the printout.

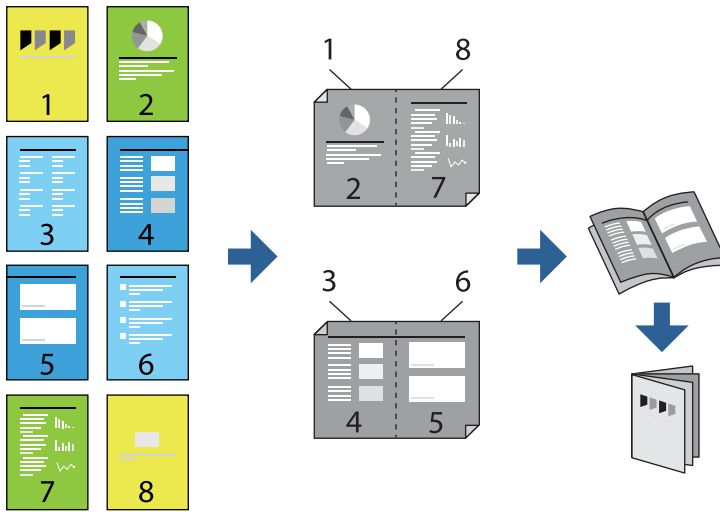

Note:

- If you do not use paper that is suitable for 2-sided printing, the print quality may decline and paper jams may occur.
[“Paper for 2-Sided Printing” on page 175](#)
- Depending on the paper and the data, ink may bleed through to the other side of the paper.
- You cannot perform manual 2-sided printing unless **EPSON Status Monitor 3** is enabled. If **EPSON Status Monitor 3** is disabled, access the printer driver window, click **Extended Settings** on the **Maintenance** tab, and then select **Enable EPSON Status Monitor 3**.
- However, manual 2-sided printing may not be available when the printer is accessed over a network or is used as a shared printer.

1. On the printer driver's **Main** tab, select the type of long-edge binding you want to use from **2-Sided Printing**.
2. Click **Settings**, select **Booklet**, and then select **Center Binding** or **Side Binding**.
 - Center Binding:** Use this method when printing a small number of pages that can be stacked and easily folded in half.
 - Side Binding.** Use this method when printing one sheet (four pages) at a time, folding each in half, and then putting them together in one volume.
3. Click **OK**.
4. When printing data that has a lot of photos and images, click **Print Density**, and then make the appropriate settings, and then click **OK**.

When setting **Print Density**, you can adjust print density according to the document type.

Note:

Printing may be slow depending on the combination of options selected for **Select Document Type** in the **Print Density Adjustment** window and for **Quality** on the **Main** tab.

5. Set the other items on the **Main** and **More Options** tabs as necessary, and then click **OK**.

[“Main Tab” on page 82](#)

[“More Options Tab” on page 83](#)

6. Click **Print**.

Related Information

- ➔ “Available Paper and Capacities” on page 173
- ➔ “Loading Paper” on page 77
- ➔ “Printing Using Easy Settings” on page 80

Printing Several Pages on One Sheet

You can print several pages of data on a single sheet of paper.

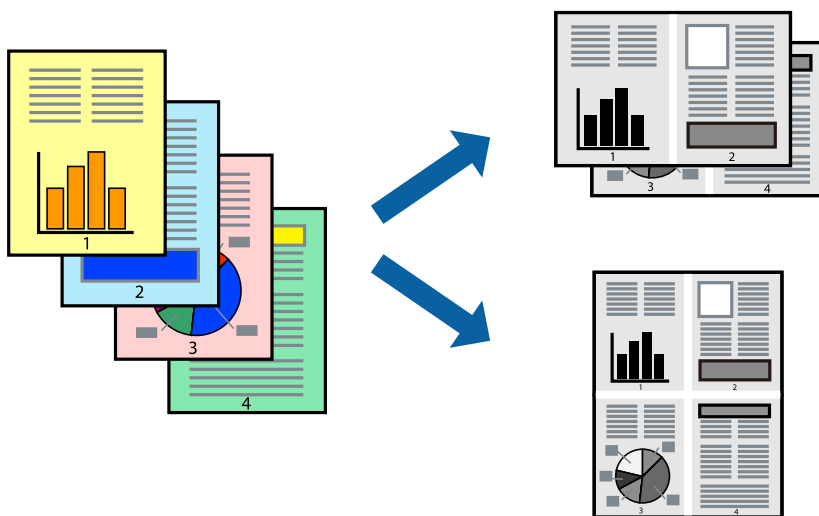

1. On the printer driver's **Main** tab, select **2-Up**, **4-Up**, **6-Up**, **8-Up**, **9-Up**, or **16-Up** as the **Multi-Page** setting.
2. Click **Layout Order**, make the appropriate settings, and then click **OK**.
3. Set the other items on the **Main** and **More Options** tabs as necessary, and then click **OK**.

“Main Tab” on page 82

“More Options Tab” on page 83

4. Click **Print**.

Related Information

- ➔ “Loading Paper” on page 77
- ➔ “Printing Using Easy Settings” on page 80

Printing to Fit the Paper Size

Select the paper size you loaded in the printer as the Destination Paper Size setting.



1. On the printer driver's **More Options** tab, make the following settings.
 - Document Size: Select the size of the paper you set in the application setting.
 - Output Paper: Select the paper size you loaded in the printer.
Fit to Page is automatically selected.

Note:

Click **Center** to print the reduced image in the middle of the paper.

2. Set the other items on the **Main** and **More Options** tabs as necessary, and then click **OK**.
 - [“Main Tab” on page 82](#)
 - [“More Options Tab” on page 83](#)
3. Click **Print**.

Related Information

- ➔ [“Loading Paper” on page 77](#)
- ➔ [“Printing Using Easy Settings” on page 80](#)

Printing a Reduced or Enlarged Document at any Magnification

You can reduce or enlarge the size of a document by a specific percentage.



1. On the printer driver's **More Options** tab, select the document size from the **Document Size** setting.
2. Select the paper size you want to print on from the **Output Paper** setting.
3. Select **Reduce/Enlarge Document, Zoom to**, and then enter a percentage.
Select **Center** to print the images in the center of the page.
4. Set the other items on the **Main** and **More Options** tabs as necessary, and then click **OK**.
[“Main Tab” on page 82](#)
[“More Options Tab” on page 83](#)
5. Click **Print**.

Related Information

- ➔ [“Loading Paper” on page 77](#)
- ➔ [“Printing Using Easy Settings” on page 80](#)

Printing One Image on Multiple Sheets for Enlargement (Creating a Poster)

This feature allows you to print one image on multiple sheets of paper. You can create a larger poster by taping them together.

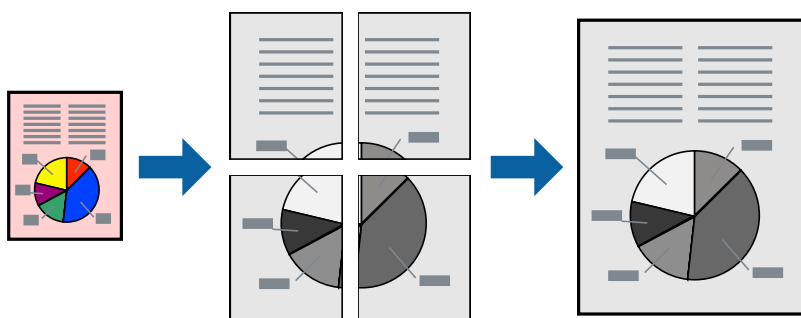

Note:

This feature is not available with 2-sided printing.

1. On the printer driver's **Main** tab, select **2x1 Poster**, **2x2 Poster**, **3x3 Poster**, or **4x4 Poster** as the **Multi-Page** setting.

2. Click **Settings**, make the appropriate settings, and then click **OK**.

Note:

Print Cutting Guides allows you to print a cutting guide.

3. Set the other items on the **Main** and **More Options** tabs as necessary, and then click **OK**.

[“Main Tab” on page 82](#)

[“More Options Tab” on page 83](#)

4. Click **Print**.

Related Information

➔ [“Loading Paper” on page 77](#)

➔ [“Printing Using Easy Settings” on page 80](#)

Making Posters Using Overlapping Alignment Marks

Here is an example of how to make a poster when **2x2 Poster** is selected, and **Overlapping Alignment Marks** is selected in **Print Cutting Guides**.

The actual guides are printed in monochrome, but for this explanation they are shown as blue and red lines.

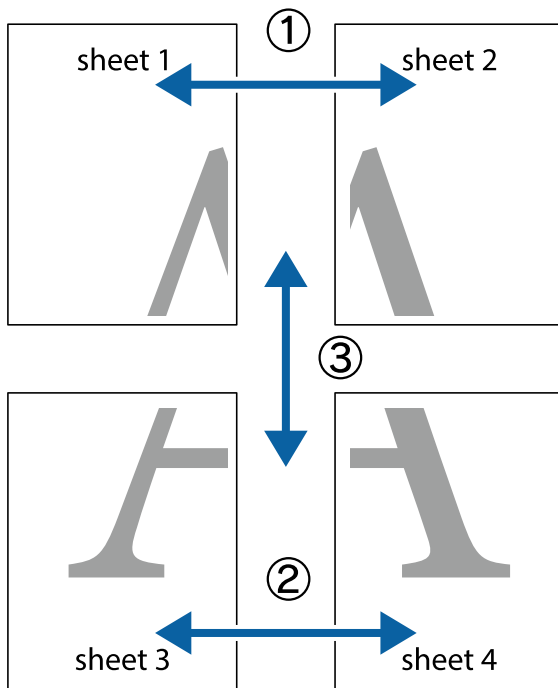

1. Prepare Sheet 1 and Sheet 2. Cut off the margins of Sheet 1 along the vertical blue line through the center of the top and bottom cross marks.

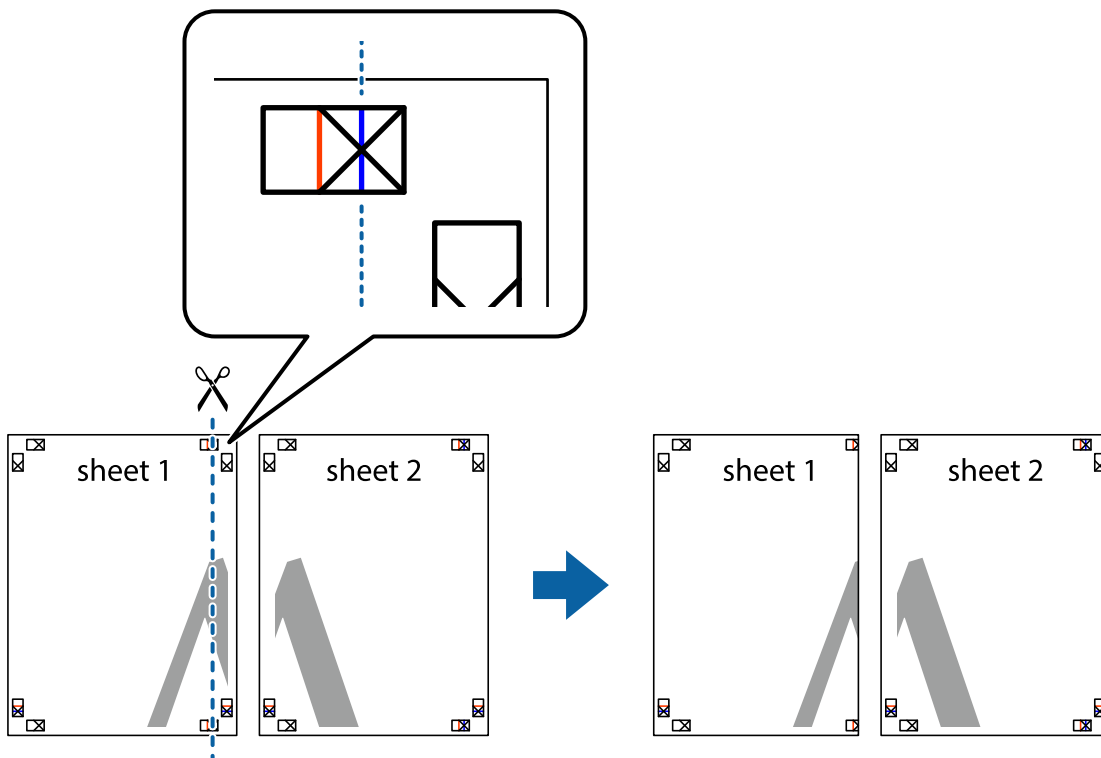

2. Place the edge of Sheet 1 on top of Sheet 2 and align the cross marks, then temporarily tape the two sheets together from the back.

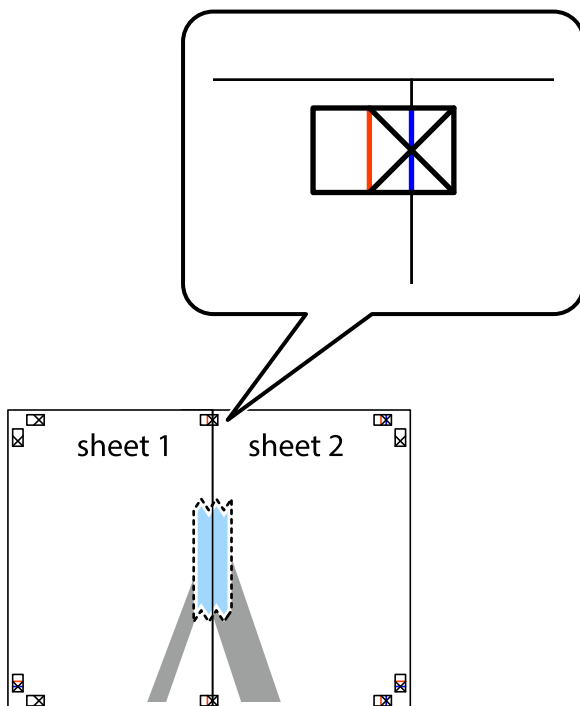

- Cut the taped sheets in two along the vertical red line through the alignment markers (this time, the line to the left of the cross marks).

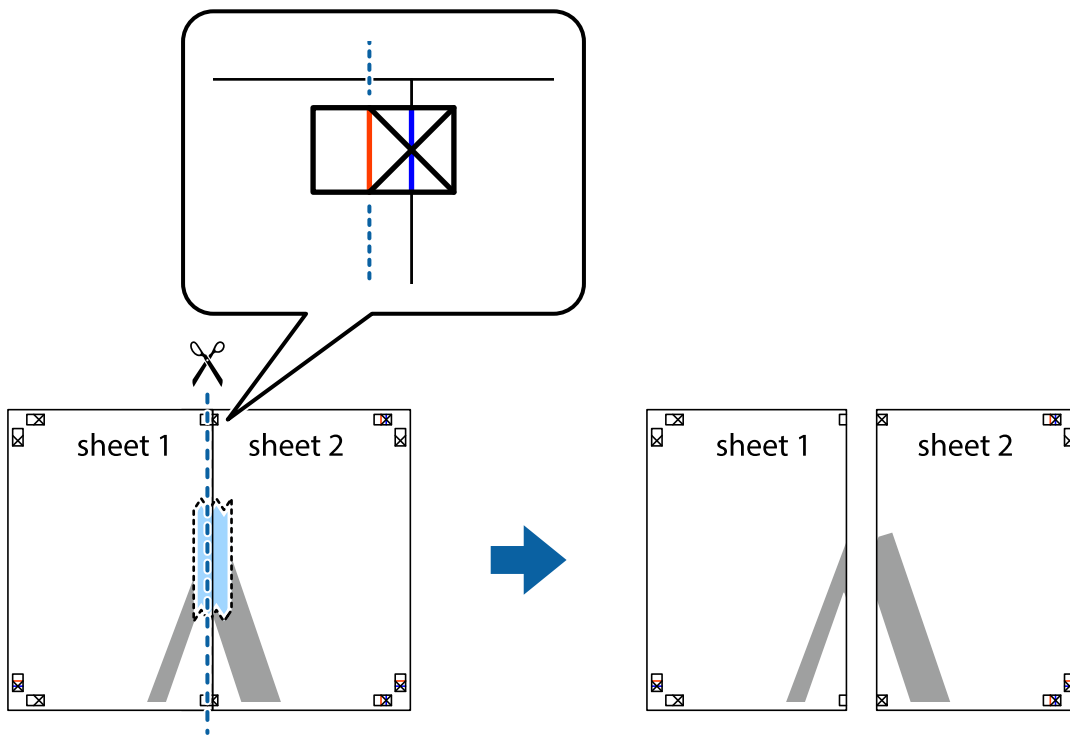

- Tape the sheets together from the back.

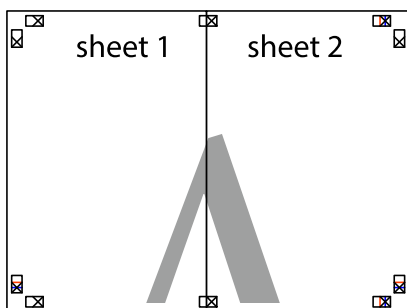

- Repeat steps 1 to 4 to tape Sheet 3 and Sheet 4 together.

- Cut off the margins of Sheet 1 and Sheet 2 along the horizontal blue line through the center of the left and right side cross marks.

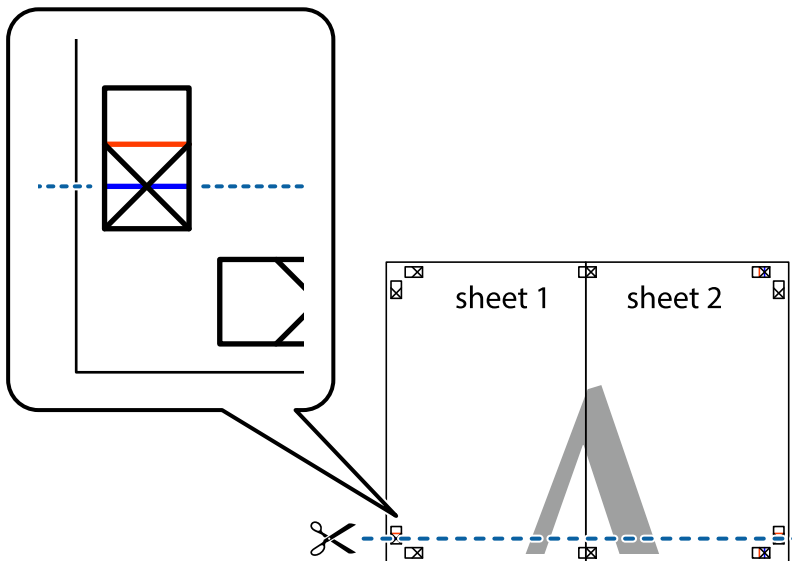

- Place the edge of Sheet 1 and Sheet 2 on top of Sheet 3 and Sheet 4 and align the cross marks, and then temporarily tape them together from the back.

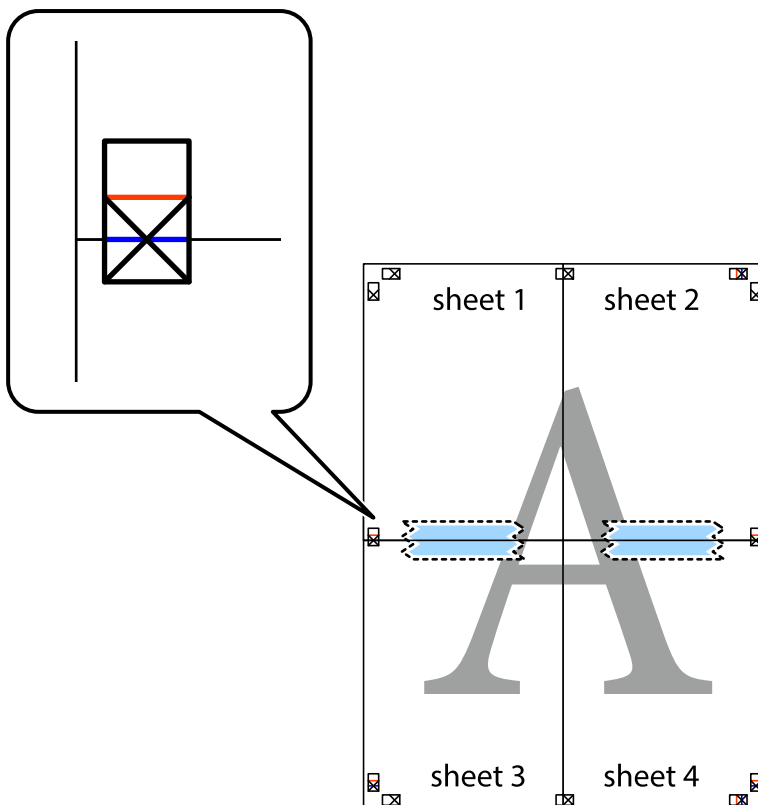

- Cut the taped sheets in two along the horizontal red line through the alignment markers (this time, the line above the cross marks).

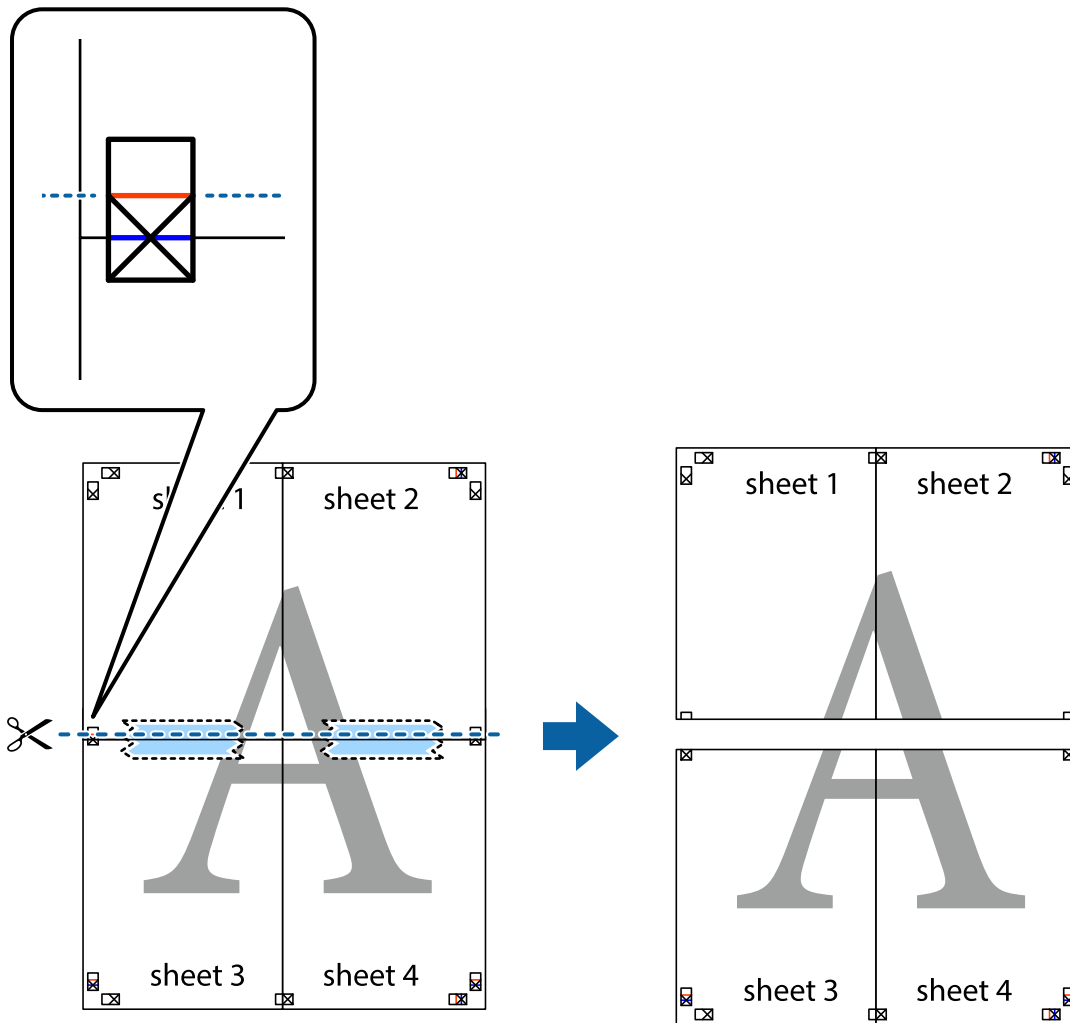

- Tape the sheets together from the back.

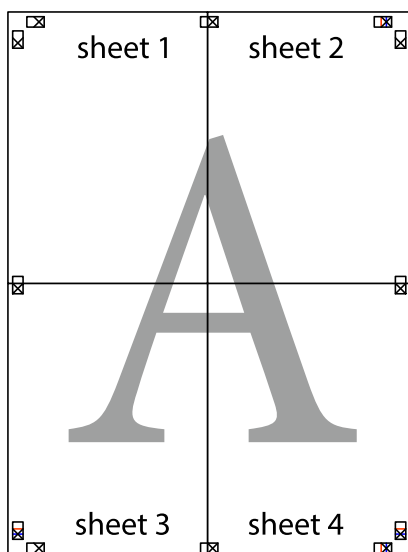

10. Cut off the remaining margins along the outer guide.

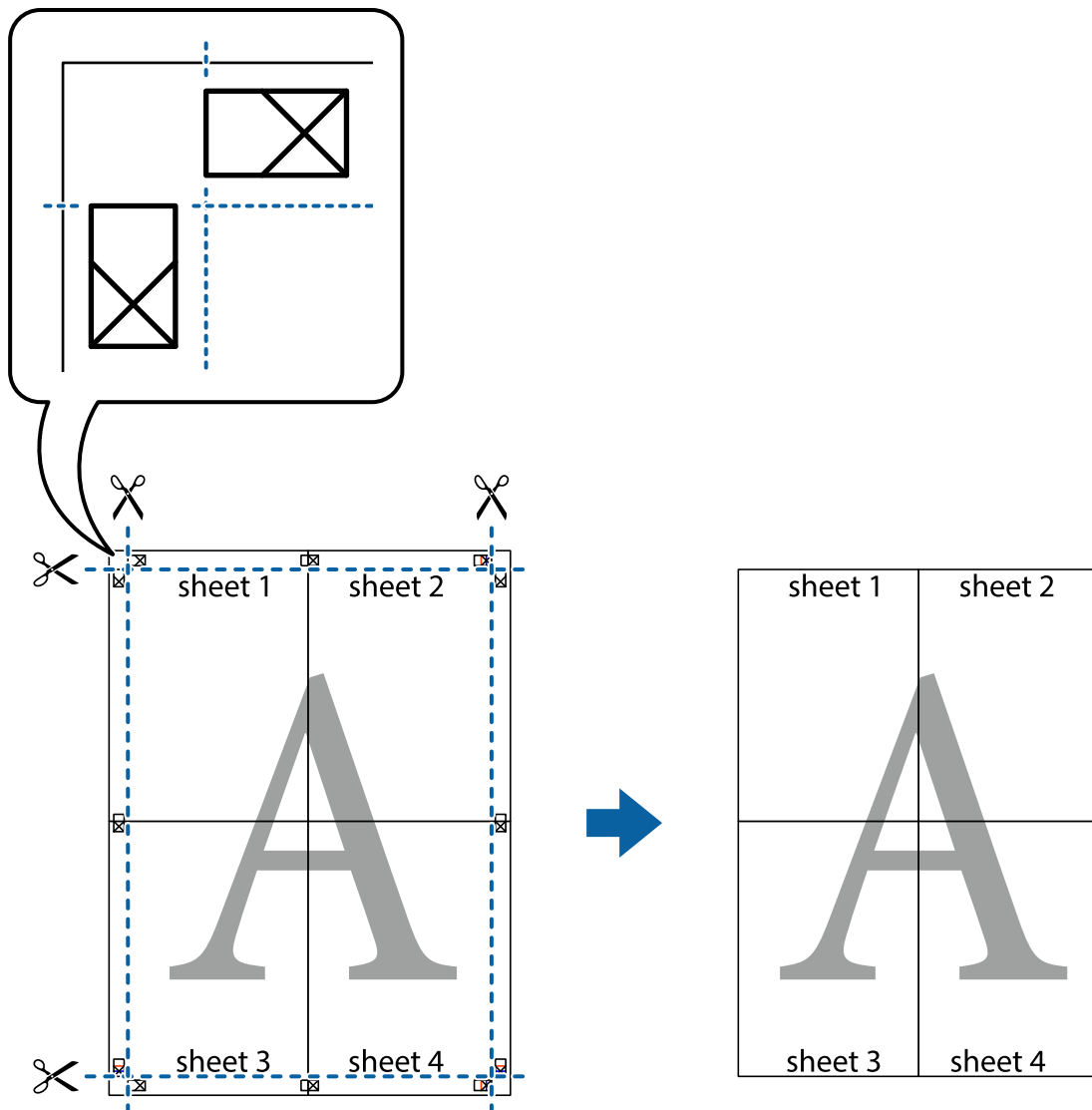

Printing with a Header and Footer

You can print information such as a user name and printing date in headers or footers.

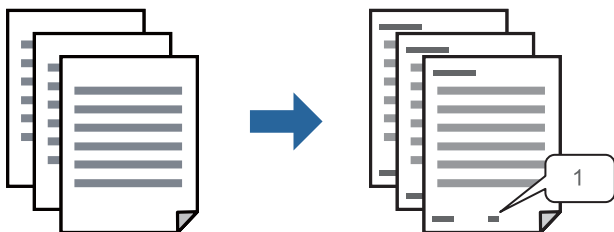

1. On the printer driver's **More Options** tab, click **Watermark Features**, and then select **Header/Footer**.

2. **Settings**, and then select the items you want to print and then click OK.

Note:

- To specify the first page number, select **Page Number** from the position you want to print in the header or footer, and then select the number in **Starting number**.
- If you want to print text in the header or footer, select the position you want to print, and then select **Text**. Enter the text you want to print in the text input field.

3. Set the other items on the **Main** and **More Options** tabs as necessary, and then click **OK**.

[“Main Tab” on page 82](#)

[“More Options Tab” on page 83](#)

4. Click **Print**.

Related Information

- ➔ [“Loading Paper” on page 77](#)
- ➔ [“Printing Using Easy Settings” on page 80](#)

Printing an Anti-Copy Pattern

You can print an anti-copy pattern on your printouts. When printing, the letters themselves are not printed and the entire print is screen-toned lightly. The hidden letters appear when photocopied to easily distinguish the original from the copies.



Anti-Copy Pattern is available under the following conditions:

- Paper Type: Plain paper, Letterhead, Recycled, Color, Preprinted, High quality plain paper, or Thick paper1
- Quality: Standard
- 2-Sided Printing: Off, Manual (Long-edge binding), or Manual (Short-edge binding)
- Tone Correction: Automatic

Note:

You can also add your own anti-copy pattern.

1. On the printer driver's **More Options** tab, click **Watermark Features**, and then select Anti-Copy Pattern.
2. Click **Settings** to change details such as the size or density of the pattern.
3. Set the other items on the **Main** and **More Options** tabs as necessary, and then click **OK**.

[“Main Tab” on page 82](#)

[“More Options Tab” on page 83](#)

4. Click **Print**.

Related Information

- ➔ [“Loading Paper” on page 77](#)
- ➔ [“Printing Using Easy Settings” on page 80](#)

Printing Password-Protected Job

You can set a password for a print job so that it starts printing only after entering the password on the printer's control panel.

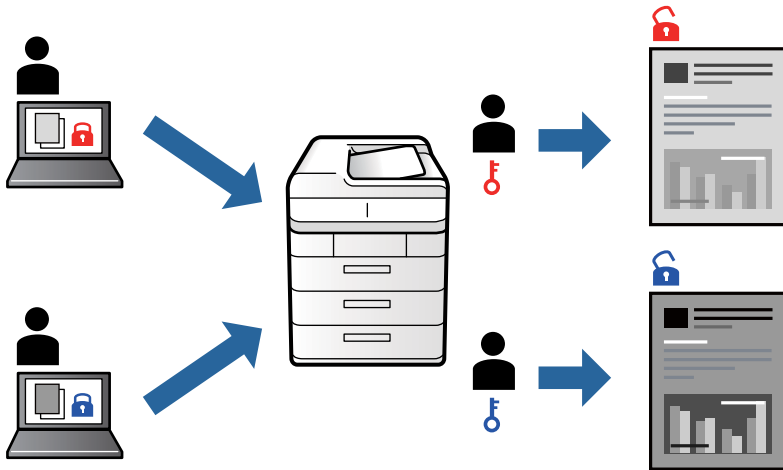

1. On the printer driver's **More Options** tab, select **Confidential Job**, and then enter a password, and click **OK**.
2. Set the other items as necessary, and then click **OK**.
3. Click **Print**.
4. To print the job, select **Print From Internal Memory** on the home screen of the printer's control panel. Select the job you want to print, and then enter the password.

Related Information

- ➔ [“Loading Paper” on page 77](#)
- ➔ [“Printing Using Easy Settings” on page 80](#)

Printing Multiple Files Together

Job Arranger Lite allows you to combine several files created by different applications and print them as a single print job. You can specify the print settings for combined files, such as multi-page layout, and 2-sided printing.

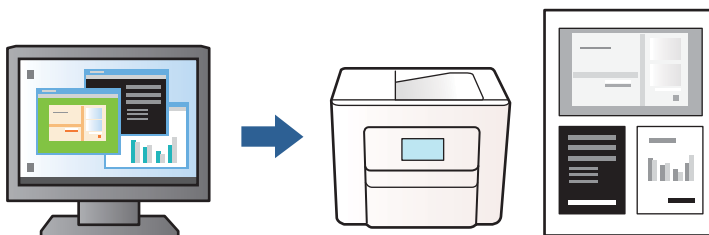

1. On the printer driver's **Main** tab, select **Job Arranger Lite**, and then click **OK**.

[“Main Tab” on page 82](#)

2. Click **Print**.

When you start printing, the Job Arranger Lite window is displayed.

3. With the Job Arranger Lite window opened, open the file that you want to combine with the current file, and then repeat the above steps.

4. When you select a print job added to Print Project in the Job Arranger Lite window, you can edit the page layout.

5. Click **Print** from the **File** menu to start printing.

Note:

*If you close the Job Arranger Lite window before adding all the print data to the Print Project, the print job you are currently working on is canceled. Click **Save** from the **File** menu to save the current job. The extension of the saved files is ".ecl".*

*To open a Print Project, click **Job Arranger Lite** on the printer driver's **Maintenance** tab to open the Job Arranger Lite window. Next, select **Open** from the **File** menu to select the file.*

Related Information

➔ [“Loading Paper” on page 77](#)

➔ [“Printing Using Easy Settings” on page 80](#)

Adjusting the Print Tone

You can adjust the tone used in the print job. These adjustments are not applied to the original data.

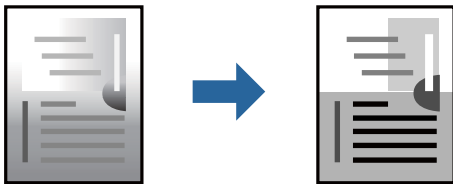

1. On the printer driver's **More Options** tab, select the method of tone correction from the **Tone Correction** setting.

Automatic: This setting automatically adjusts the tone to match the paper type and print quality settings.

Custom: Click **Advanced**, you can make your own settings.

2. Set the other items on the **Main** and **More Options** tabs as necessary, and then click **OK**.

[“Main Tab” on page 82](#)

[“More Options Tab” on page 83](#)

3. Click **Print**.

Related Information

➔ [“Loading Paper” on page 77](#)

➔ [“Printing Using Easy Settings” on page 80](#)

Printing to Emphasize Thin Lines

You can thicken thin lines that are too thin to print.

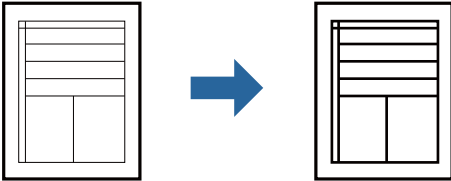

1. On the printer driver's **More Options** tab, click **Image Options** in the **Tone Correction** setting.
2. Select **Emphasize Thin Lines**.
3. Set the other items on the **Main** and **More Options** tabs as necessary, and then click **OK**.
[“Main Tab” on page 82](#)
[“More Options Tab” on page 83](#)
4. Click **Print**.

Related Information

- ➔ [“Loading Paper” on page 77](#)
- ➔ [“Printing Using Easy Settings” on page 80](#)

Printing Clear Bar Codes

If printed bar codes cannot be read correctly, you can print clearly using reduced ink bleeding. Only enable this feature if the bar code you printed cannot be scanned.

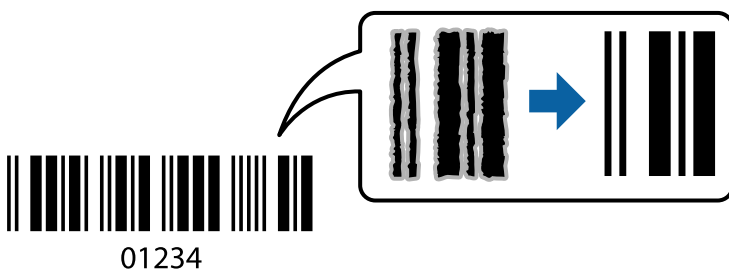

You can use this feature under the following conditions.

- Paper Type: Plain paper, Letterhead, Recycled, Color, Preprinted, High quality plain paper, Thick paper1, Thick paper2, Epson Matte, Epson Photo Quality Ink Jet, or Envelope
- Quality: **Standard**

1. On the printer driver's **Maintenance** tab, click **Extended Settings**, and then select **Barcode mode**.

2. Set the other items on the **Main** and **More Options** tabs as necessary, and then click **OK**.

[“Main Tab” on page 82](#)

[“More Options Tab” on page 83](#)

3. Click **Print**.

Note:

Deblurring may not always be possible depending on the circumstances.

Related Information

➔ [“Loading Paper” on page 77](#)

➔ [“Printing Using Easy Settings” on page 80](#)

Printing a Document Using the PostScript Printer Driver (Windows)

A PostScript Printer Driver is a driver that outputs printing commands to a printer using a PostScript Page Description Language.

1. Open the file you want to print.
Load paper in the printer if it has not already been loaded.
2. Select **Print** or **Print Setup** from the **File** menu
3. Select your printer.
4. Select **Preferences** or **Properties** to access the printer driver window.

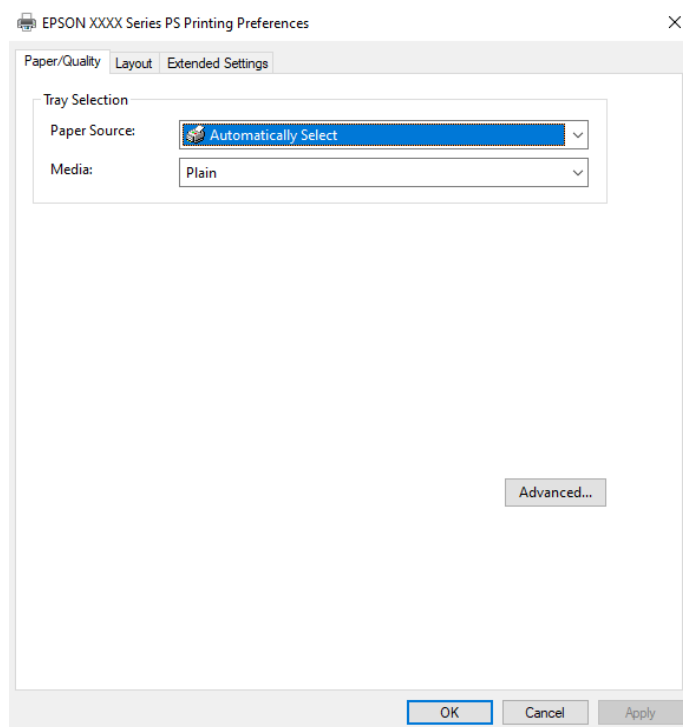

5. Change the settings as necessary.
See the menu options for the printer driver for details.
6. Click **OK** to close the printer driver for details.
7. Click **Print**.

Related Information

- ➔ [“Available Paper and Capacities” on page 173](#)
- ➔ [“Loading Paper” on page 77](#)
- ➔ [“List of Paper Type” on page 76](#)
- ➔ [“Paper/Quality Tab” on page 103](#)
- ➔ [“Layout Tab” on page 103](#)

Menu Options for the PostScript Printer Driver

Open the print window on an application, select the printer, and then access the printer driver window.

Note:

Menus vary depending on the option you selected.

Paper/Quality Tab

Tray Selection:

Select the paper source and media.

Paper Source:

Select the paper source from which the paper is fed.

Select **Automatically Select** to automatically select the paper source selected in the **Paper Setting** on the printer.

Media:

Select the type of paper on which you print. If you select **Unspecified**, printing is performed from the paper source for which the paper type is set to the following in the printer's settings.

Plain paper, Recycled, High quality plain paper

However, paper cannot be fed from a paper source for which the paper source is set to off in the printer's **Auto Select Settings**.

Layout Tab

Orientation:

Select the orientation you want to use to print.

Print on Both Sides:

Allows you to perform 2-sided printing.

Page Order:

Select to print from the top or the last page. If you select **Back to Front**, the pages are stacked in the correct order based on page number after printing.

Page Format:

Pages per Sheet:

Pages per Sheet Layout:

Allows you to specify the page layout when printing several pages on one sheet.

Booklet:

Booklet Binding:

Select the binding position for booklet.

Draw Borders:

Select this if you want to place a border line for each page when printing several pages on one sheet or when creating a booklet.

Extended Settings Tab

Job Settings:

If the printer usage has been restricted by the administrator, printing is available after you register your account on the printer driver. Contact the administrator for your user account.

Save Access Control settings:

Allows you to enter a user name and password.

User Name:

Enter a user name.

Password:

Enter a password.

Reserve Job Settings:

Make settings for print jobs stored in the printer's memory.

Confidential Job:

Select **Confidential Job** and enter the password. The printer will not print until you enter the password on the printer's control panel.

Password:

Enter the Confidential Job password.

User Name:

Enter a user name.

Job Name:

Enter a job name.

Advanced Options

Paper/Output:

Select the paper size and number of copies.

Paper Size:

Select the paper size on which you want to print.

Copies:

Set the number of copies you want to print.

Graphic:

Set the following menu items.

Print Quality:

Select the print quality you want to use for printing.

Scaling:

Allows you to reduce or enlarge the document.

TrueType Font:

Sets the font substitute to TrueType Font.

Document Options:

Advanced Printing Features:

Allows you to make detailed settings for printing features.

PostScript Options:

Allows you to make optional settings.

Printer Features:

Set the following menu items.

Ink Save Mode:

Conserves ink by reducing the print density.

Rotate by 180°:

Rotates the data 180 degrees before printing.

Printing from a Computer - Mac OS

Printing Using Easy Settings

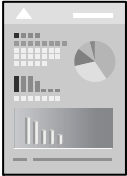

Note:

Operations and screens differ depending on the application. See the application's help for details.

1. Load paper in the printer .
[“Loading Paper” on page 77](#)
2. Open the file you want to print.
3. Select **Print** from the **File** menu or another command to access the print dialog.
If necessary, click **Show Details** or ▼ to expand the print window.
4. Select your printer.

5. Select **Print Settings** from the pop-up menu.

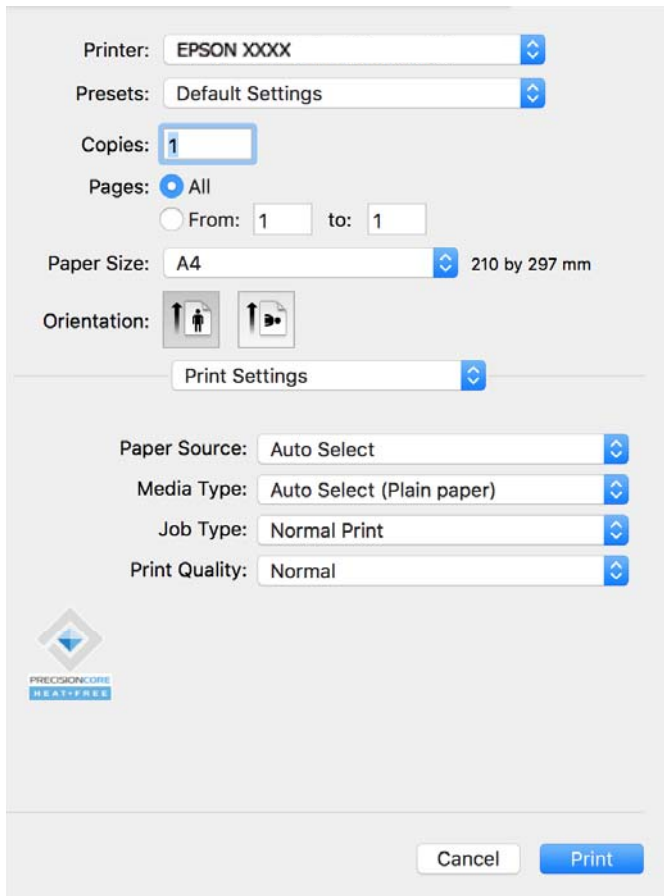

Note:

If the **Print Settings** menu is not displayed on macOS Catalina (10.15) or later, macOS High Sierra (10.13), macOS Sierra (10.12), OS X El Capitan (10.11), OS X Yosemite (10.10), OS X Mavericks (10.9), the Epson printer driver has not been installed correctly. Enable it from the following menu.

Select **System Preferences** from the Apple menu > **Printers & Scanners** (or **Print & Scan**, **Print & Fax**), remove the printer, and then add the printer again. See the following to add a printer.

[“Adding a Genuine Epson Printer \(for Mac OS Only\)” on page 135](#)

macOS Mojave (10.14) cannot access **Print Settings** in applications made by Apple such as TextEdit.

6. Change the settings as necessary.
See the menu options for the printer driver for details.

7. Click **Print**.

Note:

If you want to cancel printing, on your computer click the printer icon in the **Dock**. Select the job you want to cancel, and then click  next to the progress meter. However, you cannot cancel a print job from the computer once it has been completely sent to the printer. In this case, cancel the print job by using the printer's control panel.

Related Information

- ➔ [“Available Paper and Capacities” on page 173](#)
- ➔ [“List of Paper Type” on page 76](#)

➔ [“Menu Options for Print Settings” on page 109](#)

Menu Options for the Printer Driver

Open the print window in an application, select the printer, and then access the printer driver window.

Note:

Menus vary depending on the option you selected.

Menu Options for Layout

Pages per Sheet:

Select the number of pages to be printed on one sheet.

Layout Direction:

Specify the order in which the pages will be printed.

Border:

Prints a border around the pages.

Reverse page orientation:

Rotates pages 180 degrees before printing. Select this item when printing on paper such as envelopes that are loaded in fixed direction in the printer.

Flip horizontally:

Inverts an image to print as it would appear in a mirror.

Menu Options for Color Matching

ColorSync/EPSON Color Controls:

Select the method for color adjustment. These options adjust colors between the printer and the computer display to minimize the difference in tone.

Menu Options for Paper Handling

Collate pages:

Prints multi-page documents collated in order and sorted into sets.

Pages to Print:

Select to print only odd pages or even pages.

Page Order:

Select to print from the top or the last page.

Scale to fit paper size:

Prints to fit to the paper size you loaded.

Destination Paper Size:

Select the paper size to print on.

Scale down only:

Select this when you want to reduce the size only if the print data is too large for the paper size loaded in the printer.

Menu Options for Cover Page

Print Cover Page:

Select whether or not to print a cover page. When you want to add a back cover, select **After document**.

Cover Page Type:

Select the contents of the cover page.

Menu Options for Print Settings

Paper Source:

Select the paper source from which the paper is fed. Select **Auto Select** to automatically select the paper source selected in the print settings on the printer.

Media Type:

Select the type of paper on which you print. If you select **Auto Select (Plain paper)**, printing is performed from the paper source for which the paper type is set to the following in the printer's settings.

Plain paper, Recycled, High quality plain paper

However, paper cannot be fed from a paper source for which the paper source is set to off in the printer's **Auto Select Settings**.

Job Type:

If you select **Confidential Job**, the print data is stored in the printer and can only be printed after the password has been entered using the printer's control panel. Set the password in **Confidential Job Settings** on the Utilities screen.

Print Quality:

Select the print quality you want to use for printing. The options vary depending on the paper type.

Menu Options for Color Options

You can adjust the brightness and contrast.

Menu Options for Two-sided Printing Settings

Two-sided Printing:

Prints on both sides of the paper.

Adding Printing Presets for Easy Printing

If you create your own preset of frequently used print settings on the printer driver, you can print easily by selecting the preset from the list.

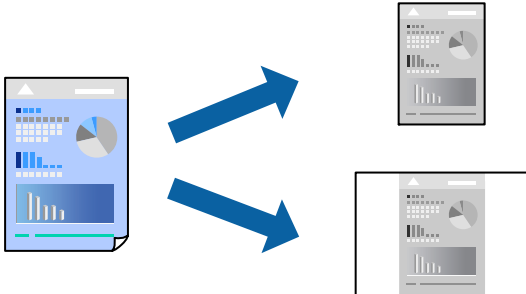

1. Set each item such as **Print Settings** and **Layout (Paper Size, Media Type, and so on)**.
2. Click **Presets** to save the current settings as a preset.
3. Click **OK**.

Note:

To delete an added preset, click **Presets > Show Presets**, select the preset name you want to delete from the list, and then delete it.

4. Click **Print**.

The next time you want to print using the same settings, select the registered preset name from the **Presets**.

Related Information

- ➔ [“Loading Paper” on page 77](#)
- ➔ [“Printing Using Easy Settings” on page 106](#)

Printing on 2-Sides

You can print on both sides of the paper.

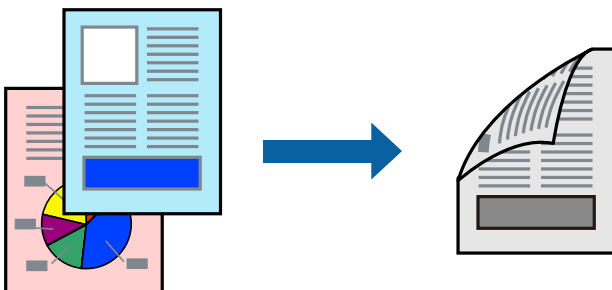

Note:

- If you do not use paper that is suitable for 2-sided printing, the print quality may decline and paper jams may occur.
[“Paper for 2-Sided Printing” on page 175](#)

- Depending on the paper and the data, ink may bleed through to the other side of the paper.

1. Select **Two-sided Printing Settings** from the pop-up menu.

2. Select the bindings in **Two-sided Printing**.
3. Set the other items as necessary.
4. Click **Print**.

Related Information

- ➔ [“Available Paper and Capacities” on page 173](#)
- ➔ [“Loading Paper” on page 77](#)
- ➔ [“Printing Using Easy Settings” on page 106](#)

Printing Several Pages on One Sheet

You can print several pages of data on a single sheet of paper.

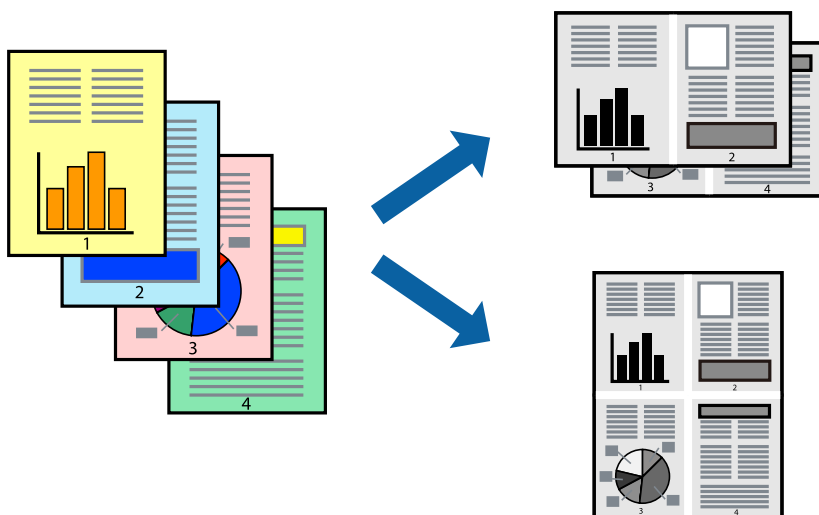

1. Select **Layout** from the pop-up menu.
2. Set the number of pages in **Pages per Sheet**, the **Layout Direction** (page order), and **Border**.
[“Menu Options for Layout” on page 108](#)
3. Set the other items as necessary.
4. Click **Print**.

Related Information

- ➔ [“Loading Paper” on page 77](#)
- ➔ [“Printing Using Easy Settings” on page 106](#)

Printing to Fit the Paper Size

Select the paper size you loaded in the printer as the Destination Paper Size setting.

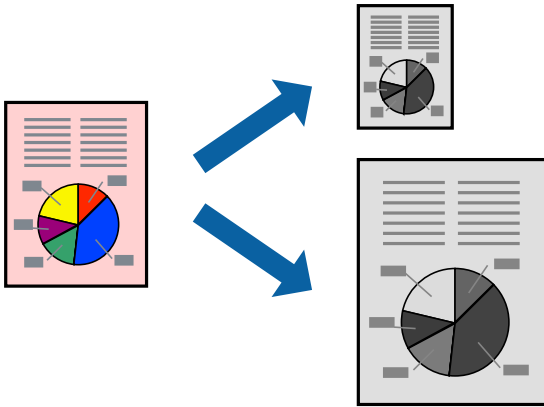

1. Select the size of the paper you set in the application as the **Paper Size** setting.
2. Select **Paper Handling** from the pop-up menu.
3. Select **Scale to fit paper size**.
4. Select the paper size you loaded in the printer as the **Destination Paper Size** setting.
5. Set the other items as necessary.
6. Click **Print**.

Related Information

- ➔ [“Loading Paper” on page 77](#)
- ➔ [“Printing Using Easy Settings” on page 106](#)

Printing a Reduced or Enlarged Document at any Magnification

You can reduce or enlarge the size of a document by a specific percentage.



Note:

Operations differ depending on the application. See the application's help for details.

1. Do one of the following.
 - Select **Print** from the **File** menu of the application. Click **Page Setup**, and then select your printer in **Format For**. Select the size of the data to be printed from **Paper Size**, enter a percentage in **Scale**, and then click **OK**.
 - Select **Page Setup** from the **File** menu of the application. Select your printer in **Format For**. Select the size of the data to be printed from **Paper Size**, enter a percentage in **Scale**, and then click **OK**. Select **Print** from the **File** menu.
2. Select your printer in **Printer**.
3. Set the other items as necessary.
4. Click **Print**.

Related Information

- ➔ [“Loading Paper” on page 77](#)
- ➔ [“Printing Using Easy Settings” on page 106](#)

Adjusting the Print Tone

You can adjust the tone used in the print job. These adjustments are not applied to the original data.



1. Select **Color Options** from the pop-up menu, and then set the brightness and contrast.
2. Set the other items as necessary.
3. Click **Print**.

Related Information

- ➔ [“Loading Paper” on page 77](#)
- ➔ [“Printing Using Easy Settings” on page 106](#)

Printing from the PostScript Printer Driver on Mac OS

A PostScript Printer Driver is a driver that outputs printing commands to a printer using a PostScript Page Description Language.

1. Open the file you want to print.
Load paper in the printer if it has not already been loaded.

2. Select **Print** or **Print Setup** from the **File** menu.

If necessary, click **Show Details** or ▼ to expand the print window.

3. Select your printer.
4. Select **Print Features** from the pop-up menu.

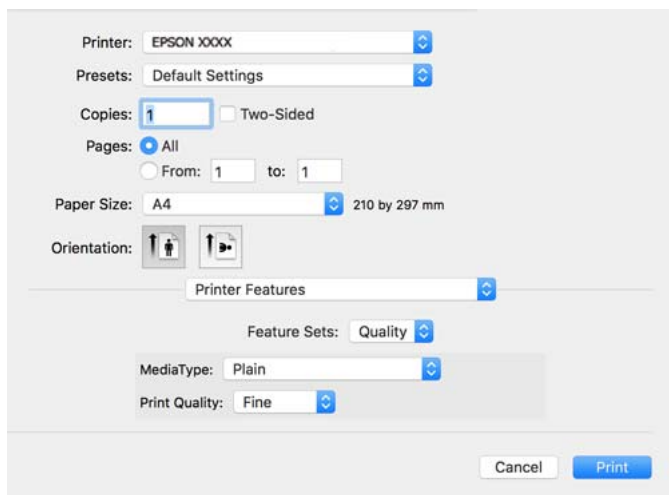

5. Change the settings as necessary.
See the menu options for the printer driver for details.
6. Click **Print**.

Related Information

- ➔ [“Available Paper and Capacities” on page 173](#)
- ➔ [“Loading Paper” on page 77](#)
- ➔ [“List of Paper Type” on page 76](#)
- ➔ [“Menu Options for Printer Features” on page 116](#)

Menu Options for the PostScript Printer Driver

Open the print window on an application, select the printer, and then access the printer driver window.

Note:

Menus vary depending on the option you selected.

Menu Options for Layout

Pages per Sheet:

Select the number of pages to be printed on one sheet.

Layout Direction:

Specify the order in which the pages will be printed.

Border:

Prints a border around the pages.

Two-Sided:

Allows you to perform 2-sided printing.

Reverse page orientation:

Rotates pages 180 degrees before printing.

Flip horizontally:

Inverts the image so that it prints as it would appear in a mirror.

Menu Options for Color Matching

ColorSync/In Printer:

Select the method for color adjustment. These options adjust color between the printer and the computer display to minimize the difference in tone.

Menu Options for Paper Handling

Collate pages:

Prints multi-page documents collated in order and sorted into sets.

Pages to Print:

Select to print only odd pages or even pages.

Page Order:

Select to print from the top or the last page.

Scale to fit paper size:

Prints to fit to the paper size you loaded.

Destination Paper Size:

Select the paper size to print on.

Scale down only:

Select when reducing the size of the document.

Menu Options for Paper Feed

Select the paper source from which the paper is fed.

All Pages From:

Selecting **Auto Select** selects the paper source that matches the **Paper Setting** on the printer automatically.

First Page From/Remaining From:

You can also select the paper source for page.

Menu Options for Cover Page

Print Cover Page:

Select whether or not to print a cover page. When you want to add a back cover, select **After document**.

Cover Page Type:

Select the contents of the cover page.

Menu Options for Job Settings

Confidential Job:

Allows you to enter a password to the print job.

User Name:

Enter a user name.

Job Name:

Enter a job name.

Password:

Enter a password.

Menu Options for Printer Features

Feature Sets:

Quality:

MediaType:

Select the type of paper on which you print. If you select **Unspecified**, printing is performed from the paper source for which the paper type is set to the following in the printer's settings.

Plain, Recycled, High quality plain paper

However, paper cannot be fed from a paper source for which the paper source is set to off in the printer's **Auto Select Settings**.

Print Quality:

Select the print quality you want to use for printing.

Others:

Ink Save Mode:

Conserves ink by reducing the print density.

Printing Documents from Smart Devices

You can print documents from a smart device such as a smartphone or tablet.

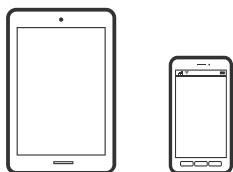

Printing Using Epson Smart Panel

Epson Smart Panel is an application that allows you to perform printer operations easily including printing from a smart device such as a smartphone or tablet. You can connect the printer and smart device over a wireless network, check the ink levels and printer status, and check for solutions if an error occurs.



Install Epson Smart Panel from the following URL or QR code.

<https://support.epson.net/smpdl/>



Start Epson Smart Panel, and then select the print menu on the home screen.

Printing Documents Using AirPrint

AirPrint enables instant wireless printing from iPhone, iPad, iPod touch, and Mac without the need to install drivers or download software.



Note:

If you disabled paper configuration messages on your printer control panel, you cannot use AirPrint. See the link below to enable the messages, if necessary.

1. Set up your printer for wireless printing. See the link below.
<https://epson.sn>
2. Connect your Apple device to the same wireless network that your printer is using.
3. Print from your device to your printer.

Note:

For details, see the AirPrint page on the Apple website.

Related Information

➔ [“Cannot Print Even Though a Connection has been Established \(iOS\)” on page 152](#)

Printing Using Epson Print Enabler

You can wirelessly print your documents, emails, photos, and web pages right from your Android phone or tablet (Android v4.4 or later). With a few taps, your Android device will discover an Epson printer that is connected to the same wireless network.

Search for and install Epson Print Enabler from Google Play.

Go to **Settings** on your Android device, select **Printing**, and then enable Epson Print Enabler. From an Android application such as Chrome, tap the menu icon and print whatever is on the screen.

Note:

If you do not see your printer, tap **All Printers** and select your printer.

Printing Using Mopria Print Service

Mopria Print Service enables instant wireless printing from Android smart phones or tablets.

Install Mopria Print Service from Google Play.



For more details, access the Mopria Web site at <https://mopria.org>.

Printing on Envelopes

Printing on Envelopes from a Computer (Windows)

1. Load envelopes in the printer.
[“Loading Paper” on page 77](#)
2. Open the file you want to print.
3. Access the printer driver window.
4. Select the envelope size from **Document Size** on the **Main** tab, and then select **Envelope** from **Paper Type**.
5. Set the other items on the **Main** and **More Options** tabs as necessary, and then click **OK**.
6. Click **Print**.

Printing on Envelopes from a Computer (Mac OS)

1. Load envelopes in the printer.
[“Loading Paper” on page 77](#)
2. Open the file you want to print.
3. Select **Print** from the **File** menu or another command to access the print dialog.
4. Select the size as the **Paper Size** setting.
5. Select **Print Settings** from the pop-up menu.
6. Select **Envelope** as the **Media Type** setting.
7. Set the other items as necessary.
8. Click **Print**.

Printing Web Pages

Printing Web Pages from Smart Devices

Install Epson Smart Panel from the following URL or QR code.

<https://support.epson.net/smpdl/>



Open the web page you want to print in your web browser app. Tap **Share** from the menu of the web browser application, select **Smart Panel**, and then start printing.

Printing Using a Cloud Service

By using Epson Connect service available on the Internet, you can print from your smartphone, tablet PC, or laptop, anytime and practically anywhere. To use this service, you need to register the user and the printer in Epson Connect.

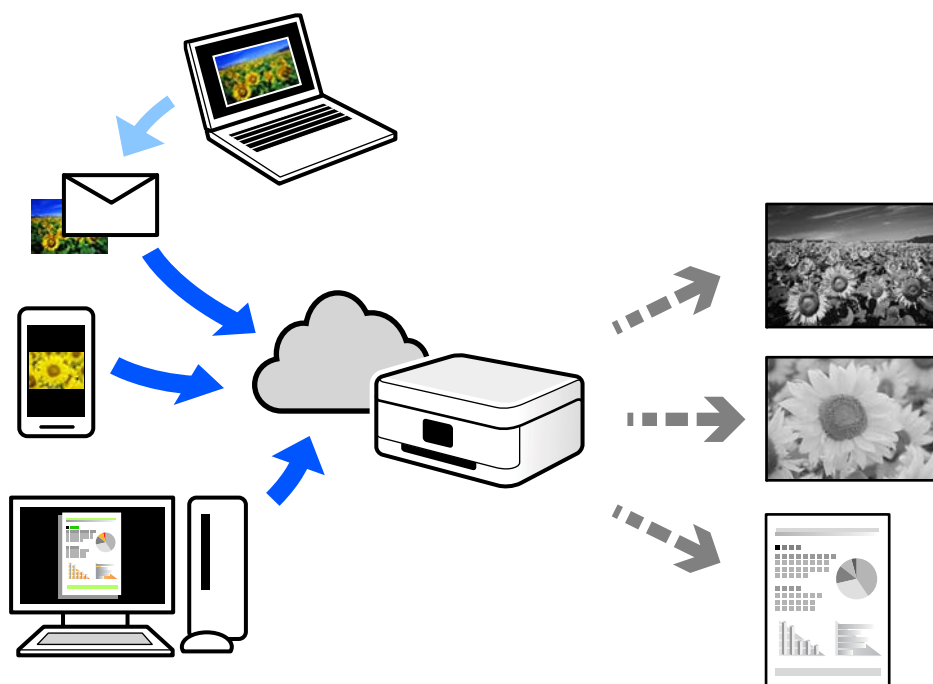

The features available on the Internet are as follows.

Email Print

When you send an email with attachments such as documents or images to an email address assigned to the printer, you can print that email and the attachments from remote locations such as your home or office printer.

Remote Print Driver

This is a shared driver supported by Remote Print Driver. When printing using a printer in a remote location, you can print by changing the printer on the usual applications window.

See the Epson Connect web portal for details on how to setup or print.

<https://www.epsonconnect.com/>





<http://www.epsonconnect.eu> (Europe only)

Maintaining the Printer

Checking the Status of Consumables.	122
Improving Print Quality.	123
Cleaning the Printer.	128

Checking the Status of Consumables

You can check the approximate ink levels and the approximate service life of the maintenance box from the printer's control panel. Select  on the home screen.

To select an item, use the     buttons, and then press the OK button.

Note:

The following indicates the amount of free space in the maintenance box.

A:Free space

B:Amount of waste ink

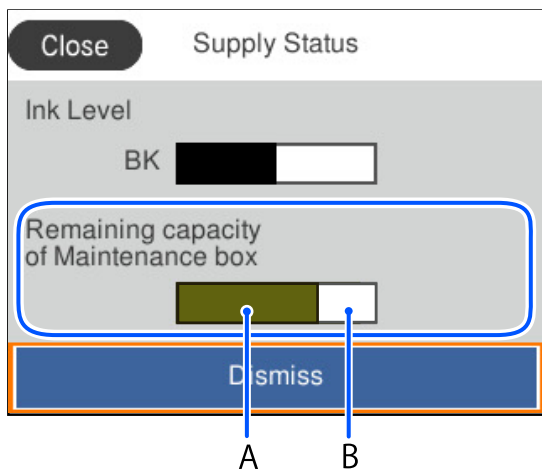

You can continue printing while the ink low message is displayed. Replace the ink supply unit when required.

Note:

You can also check the approximate ink level and the approximate service life of the maintenance box from the status monitor on the printer driver.

Windows

Click **EPSON Status Monitor 3** on the **Maintenance** tab.

If **EPSON Status Monitor 3** is disabled, click **Extended Settings** on the **Maintenance** tab, and then select **Enable EPSON Status Monitor 3**.

Mac OS

Apple menu > **System Preferences** > **Printers & Scanners** (or **Print & Scan**, **Print & Fax**) > Epson(XXXX) > **Options & Supplies** > **Utility** > **Open Printer Utility** > **EPSON Status Monitor**

Related Information

- ➔ [“It is Time to Replace Ink Supply Units” on page 163](#)
- ➔ [“It is Time to Replace the Maintenance Box” on page 164](#)

Improving Print Quality

Adjusting the Print Quality

If you notice a misaligned vertical lines, blurred images, or horizontal banding, adjust the print quality. If you want to adjust the print quality per paper, make this setting first.

1. Load A4-size plain paper in the printer.
2. Select **Maintenance** on the printer's control panel.

To select an item, use the ▲ ▼ ◀ ▶ buttons, and then press the OK button.

3. Select **Print Quality Adjustment**.
4. Follow the on-screen instructions to print the patterns for print head alignment, and then align the print head.
 - This pattern allows you to perform alignment if your printouts look blurry. Find and select the number for the most solid pattern.

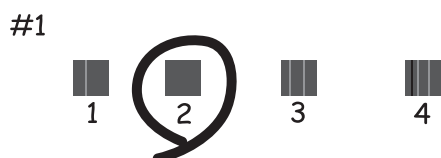

- This pattern allows you to perform alignment if vertical ruled lines appear misaligned. Find and select the number for the pattern that has the least misaligned vertical line.

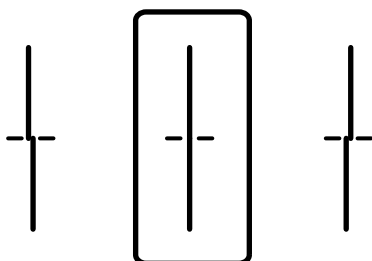

- This pattern allows you to perform alignment if you see horizontal banding at regular intervals. Find and enter the number for the least separated and overlapping pattern.

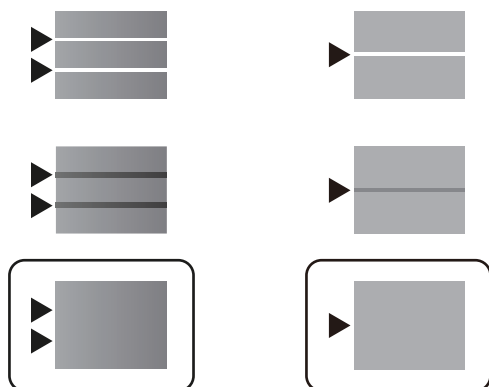

Checking and Cleaning the Print Head





If the nozzles are clogged, the printouts become faint or there is visible banding. If the nozzles are severely clogged, a blank sheet will be printed. When print quality has declined, first use the nozzle check feature to check if the nozzles are clogged. If the nozzles are clogged, clean the print head.

Important:

- Do not open the ink cover or turn off the printer during head cleaning. If the head cleaning is incomplete, you may not be able to print.
- Head cleaning consumes ink and should not be performed more than necessary.
- When ink is low, you may not be able to clean the print head.
- If print quality has not improved after repeating nozzle check and head cleaning 3 times, wait for at least 12 hours without printing, run the nozzle check once again, and then repeat head cleaning if necessary. We recommend turning off the printer by using the  button. If print quality has still not improved, contact Epson support.
- To prevent the print head from drying out, do not unplug the printer while the power is on.

You can check and clean the print head by using the printer's control panel.

1. Select **Maintenance** on the printer's control panel.

To select an item, use the     buttons, and then press the OK button.

2. Select **Print Head Nozzle Check**.

3. Follow the on-screen instructions to load paper and print the nozzle check pattern.

4. Examine the printed pattern.

- If there are broken lines or missing segments as shown in the "NG" pattern, the print head nozzles may be clogged. Go to the next step.

- If you cannot see any broken lines or missing segments as in the following "OK" pattern, the nozzles are not clogged. Print head cleaning is not necessary. Select  to exit.

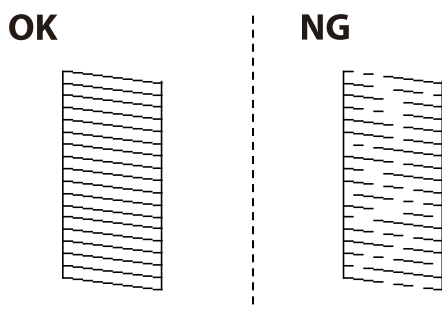

5. Select .
6. Follow the on-screen instructions to clean the print head.
7. When cleaning is finished, follow the on-screen instructions to print the nozzle check pattern again. Repeat cleaning and printing the pattern until all lines are printed completely.

Note:

You can also check and clean the print head from the printer driver.

- Windows

Click **Print Head Nozzle Check** on the **Maintenance** tab.

- Mac OS

Apple menu > **System Preferences** > **Printers & Scanners** (or **Print & Scan, Print & Fax**) > **Epson(XXXX)** > **Options & Supplies** > **Utility** > **Open Printer Utility** > **Print Head Nozzle Check**

Preventing nozzle clogging

Always use the power button when turning the printer on and off.

Check that the power light is off before you disconnect the power cord.

The ink itself can dry out if it is not covered. Just like placing a cap on a fountain pen or an oil pen to prevent it from drying, make sure the print head is capped properly to prevent the ink from drying.





When the power cord is unplugged or a power outage occurs while the printer is in operation, the print head may not be capped properly. If the print head is left as it is, it will dry out causing nozzles (ink outlets) to clog.

In these cases, turn the printer on and off again as soon as possible to cap the print head.

Aligning the Print Head

If you notice a misalignment of vertical lines or blurred images, align the print head.

1. Select **Maintenance** on the printer's control panel.

To select an item, use the     buttons, and then press the OK button.

2. Select **Print Head Alignment**.

3. Select one of the alignment menus.
 - Vertical lines look misaligned or the printouts look blurry : Select **Ruled Line Alignment**.
 - Horizontal banding occurs at regular intervals: Select **Horizontal Alignment**.
4. Follow the on-screen instructions.

Cleaning the Paper Path for Ink Smears

When the printouts are smeared or scuffed, clean the roller inside.



Important:

Do not use tissue paper to clean the inside of the printer. The print head nozzles may be clogged with lint.

1. Select **Maintenance** on the printer's control panel.

To select an item, use the ▲ ▼ ◀▶ buttons, and then press the OK button.
2. Select **Paper Guide Cleaning**.
3. Follow the on-screen instructions to load paper and clean the paper path.
4. Repeat this procedure until the paper is not smeared with ink.

Cleaning the Translucent Film

When the printout is not improved after aligning the print head or cleaning the paper path, the translucent film inside the printer may be smeared.

Items required:

- Cotton swabs (several)
- Water with a few drops of detergent (2 to 3 drops of detergent in 1/4 cup of tap water)
- Light for checking smears



Important:

Do not use cleaning liquid other than water with a few drops of detergent.

1. Turn off the printer by pressing the  button.

2. Open the printer cover.

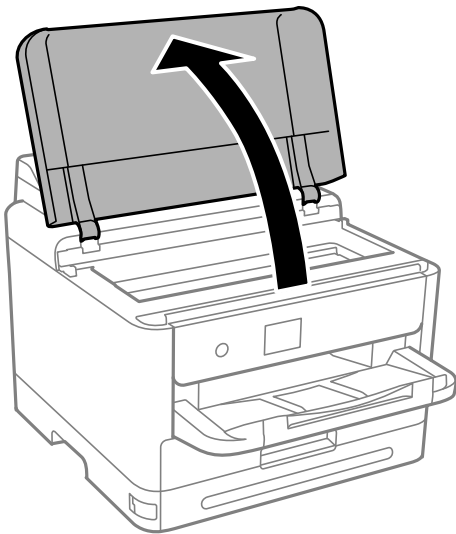

3. Check if the translucent film is smeared. Smears are easier to see if you use a light.
If there are smears (such as finger marks or grease) on the translucent film (A), go to the next step.

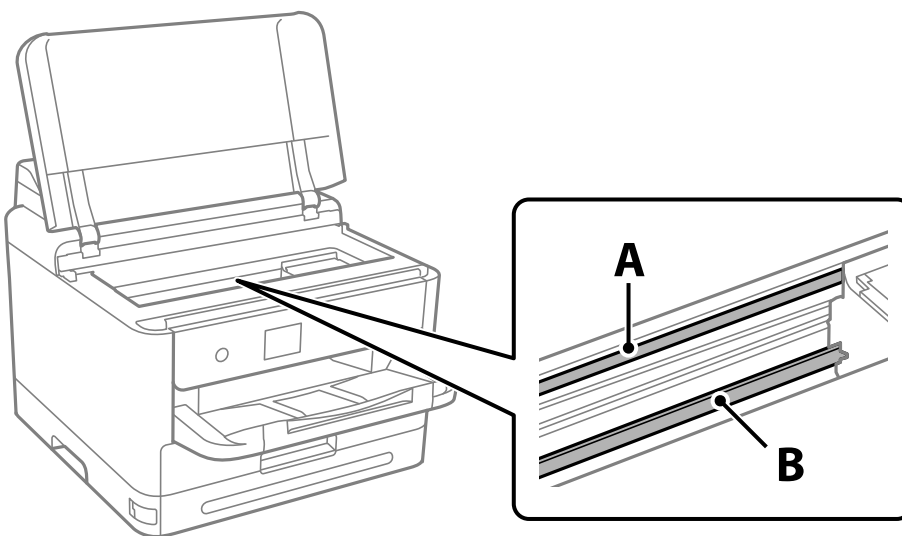

A: Translucent film

B: Rail



Important:

Be careful not to touch the rail (B). Otherwise, you may not be able to print. Do not wipe off the grease on the rail, because this is necessary for operations.

4. Moisten a cotton swab with the water with a few drops of detergent so that it is not dripping water, and then wipe the smeared part.

Be careful not to touch the ink that has adhered inside the printer.

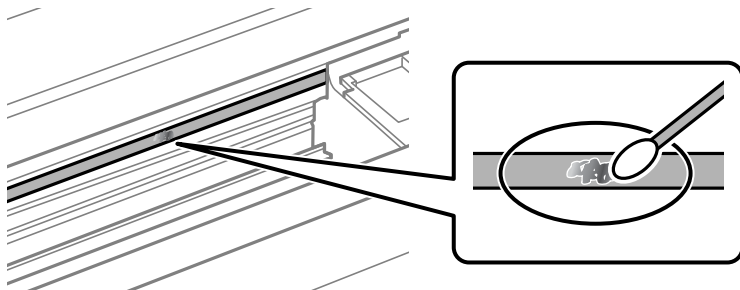

! *Important:*

Wipe off the smear gently. If you press the cotton swab too hard to the film, the springs of the film may be dislocated and the printer may be damaged.

5. Use a new dry cotton swab to wipe the film.

! *Important:*

Do not leave any fibers on the film.

Note:

To prevent the smear from spreading, frequently replace the cotton swab with a new one.

6. Repeat steps 4 and 5 until the film is not smeared.
7. Visually check that the film is not smeared.

Cleaning the Printer

If the components and the case are dirty or dusty, turn off the printer and clean them using a soft, clean cloth that has been dampened with water. If you cannot remove the dirt, try adding a small amount of mild detergent to the damp cloth.

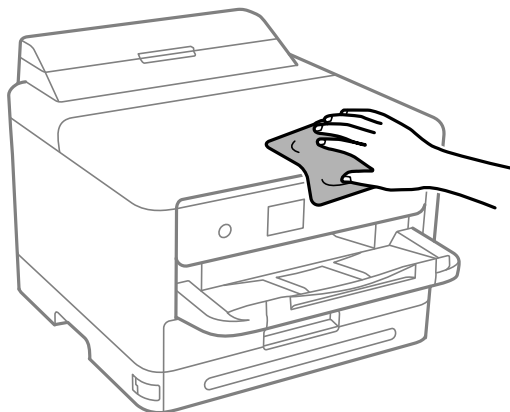

! *Important:*

- ❑ *Be careful not to get water onto the printer mechanism or any electrical components. Otherwise, the printer could be damaged.*
- ❑ *Never use alcohol or paint thinner to clean the components and the case. These chemicals can damage them.*
- ❑ *Do not touch the parts shown in the following illustration. Doing so may cause a malfunction.*

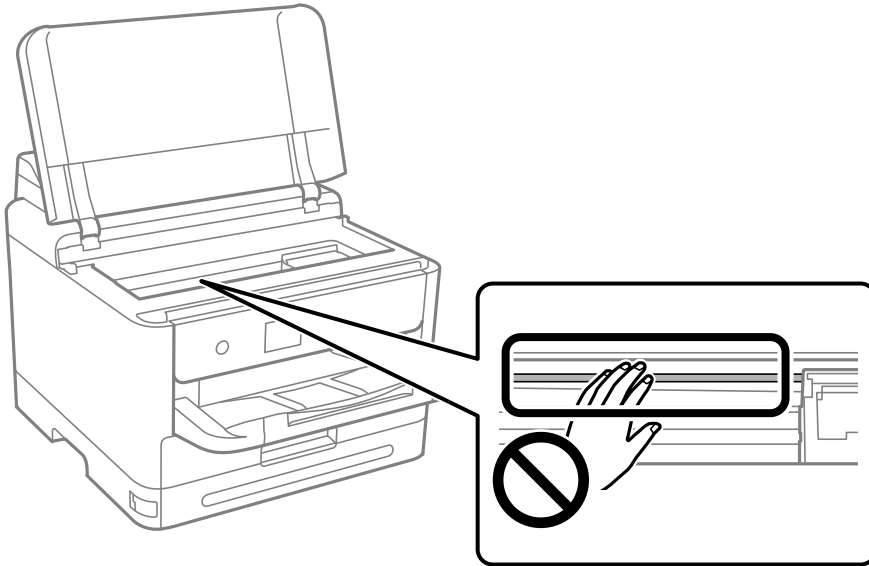

In These Situations

When the Software Disk is not Available.	131
When Replacing a Computer.	131
Installing or Uninstalling Applications Separately.	131
Making Settings for Connecting to the Computer.	137
Checking the Printer's Network Connection Status (Network Connection Report). . .	137
Connecting a Smart Device and Printer Directly (Wi-Fi Direct).	138
Changing the Connection from Wi-Fi to USB.	141
Transporting and Storing the Printer.	142

When the Software Disk is not Available

The following should only be performed if user operations are permitted.

You can download the same contents as found on the software disk from the Internet.

This is useful if your computer does not have a CD/DVD drive, or if you have lost the software disc that was supplied with the product.

Access the following website, and then enter the product name. Go to **Setup**, and then start setting up. Follow the on-screen instructions.

<https://epson.sn>

When Replacing a Computer

The following should only be performed if user operations are permitted.

You need to install the printer driver and other software on the new computer.

Access the following website, and then enter the product name. Go to **Setup**, and then start setting up. Follow the on-screen instructions.

<https://epson.sn>

Installing or Uninstalling Applications Separately

Connect your computer to the network and install the latest version of applications from the website. Log in to your computer as an administrator. Enter the administrator password if the computer prompts you.

Installing the Applications Separately

Note:

- When reinstalling an application, you need to uninstall it first.*
- You can download the latest applications from the Epson website.*
<http://www.epson.com>
- If you use Windows Server operating systems, you cannot use Epson Software Updater. Download the latest applications from the Epson website.*

1. Make sure the printer and the computer are available for communication, and the printer is connected to the Internet.

2. Start EPSON Software Updater.

The screenshot is an example on Windows.

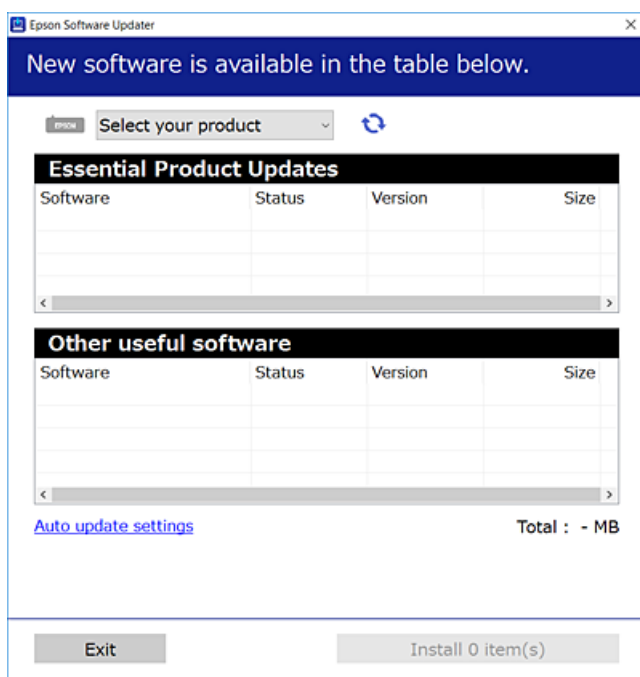

3. For Windows, select your printer, and then click  to check for the latest available applications.
4. Select the items you want to install or update, and then click the install button.



Important:

Do not turn off or unplug the printer until the update is complete. Doing so may result in malfunction of the printer.

Related Information

- ➔ [“Application for Updating Software and Firmware \(Epson Software Updater\)” on page 183](#)
- ➔ [“Uninstalling Applications” on page 135](#)

Checking if a genuine Epson printer driver is installed - Windows

You can check if a genuine Epson printer driver is installed on your computer by using one of the following methods.

Select **Control Panel > View devices and printers (Printers, Printers and Faxes)**, and then do the following to open the print server properties window.

- ❑ Windows 11/Windows 10/Windows 8.1/Windows 8/Windows 7/Windows Server 2022/Windows Server 2019/Windows Server 2016/Windows Server 2012 R2/Windows Server 2012/Windows Server 2008 R2

Click the printer icon, and then click **Print server properties** at the top of the window.

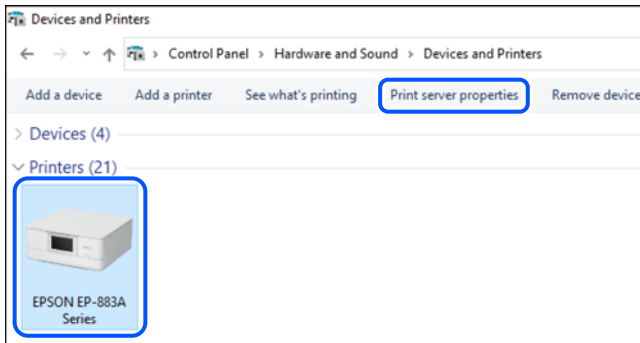

- ❑ Windows Vista/Windows Server 2008

Right-click on the **Printers** folder, and then click **Run as administrator > Server Properties**.

- ❑ Windows XP/Windows Server 2003 R2/Windows Server 2003

From the **File** menu, select **Server Properties**.

Click the **Drivers** tab. If your printer name is displayed in the list, a genuine Epson printer driver is installed on your computer.

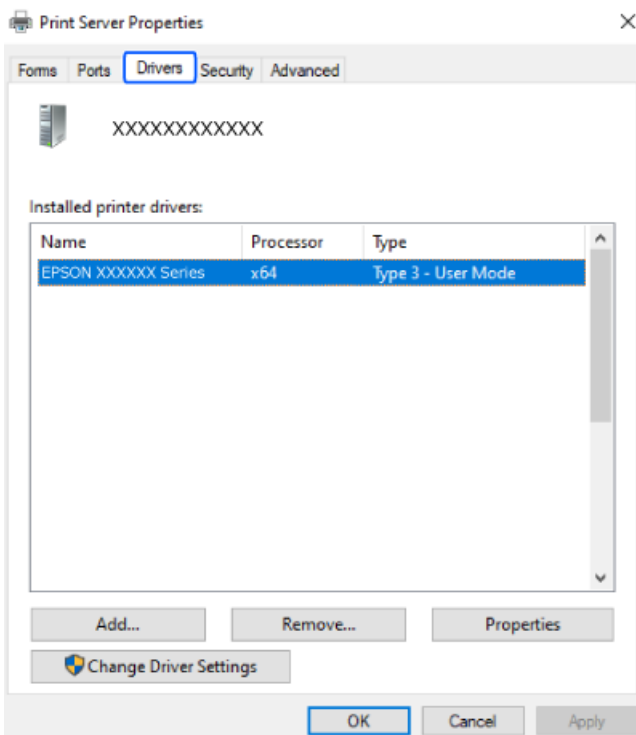

Related Information

- ➔ [“Installing the Applications Separately” on page 131](#)

Checking if a genuine Epson printer driver is installed - Mac OS

You can check if a genuine Epson printer driver is installed on your computer by using one of the following methods.

Select **System Preferences** from the Apple menu > **Printers & Scanners** (or **Print & Scan, Print & Fax**), and then select the printer. Click **Options & Supplies**, and if the **Options** tab and **Utility** tab are displayed on the window, a genuine Epson printer driver is installed on your computer.

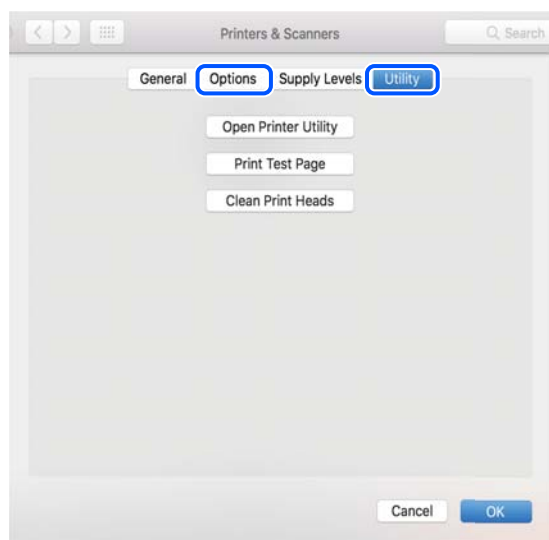

Related Information

➔ [“Installing the Applications Separately” on page 131](#)

Installing a PostScript Printer Driver

Installing a PostScript Printer Driver - Windows

1. Start the installation process from one of the following options.
 - Use the software disc supplied with the printer.**

Insert the software disc into the computer, access the following folder path, and then run SETUP64.EXE (or SETUP.EXE).

Driver\PostScript\WINX64 (or WINX86)\SETUP\SETUP64.EXE (or SETUP.EXE)
 - Download from the website.**

Access your printer page from the following website, download the PostScript printer driver, and then run the execution file.

<http://www.epson.eu/Support> (Europe)

<http://support.epson.net/> (outside Europe)
2. Select your printer.
3. Follow the on-screen instructions.

4. Select the connection method from the network connection or USB connection.

For network connection.

A list of available printers in the same network is displayed.

Select the printer you want to use.

For USB connection.

Follow the on-screen instructions to connect the printer to the computer.

5. Follow the on-screen instructions to install the PostScript printer driver.

Installing a PostScript Printer Driver - Mac OS

Download the printer driver from the Epson Support website, and then install it.

<http://www.epson.eu/Support> (Europe)

<http://support.epson.net/> (outside Europe)

You need the IP address of the printer while installing the printer driver.

Select the network icon on the printer's home screen, and then select the active connection method to confirm the printer's IP address.

Adding a Genuine Epson Printer (for Mac OS Only)

1. Select **System Preferences** from the Apple menu > **Printers & Scanners** (or **Print & Scan, Print & Fax**).

2. Click **+**, and then select your printer on the screen displayed.

3. Make the following settings.

macOS Monterey (12.x) or later

Click **Select Software** from **Use**, select your printer on the screen displayed, and then click **OK**.

Mac OS X Mavericks (10.9.5) to macOS Big Sur (11.x)

Select your printer from **Use**.

4. Click **Add**.

Note:

If your printer is not listed, check that it is correctly connected to the computer and that the printer is on.

For a USB, IP, or Bonjour connection, set the optional paper cassette unit manually after adding the printer.

Uninstalling Applications

Log in to your computer as an administrator. Enter the administrator password if the computer prompts you.

Uninstalling Applications - Windows

1. Press the  button to turn off the printer.

2. Quit all running applications.
 3. Open **Control Panel**:
 - Windows 11
Click on the start button, and then select **All apps > Windows Tools > Control Panel**.
 - Windows 10/Windows Server 2022/Windows Server 2019/Windows Server 2016
Click on the start button, and then select **Windows System > Control Panel**.
 - Windows 8.1/Windows 8/Windows Server 2012 R2/Windows Server 2012
Select **Desktop > Settings > Control Panel**.
 - Windows 7/Windows Vista/Windows XP/Windows Server 2008 R2/Windows Server 2008/Windows Server 2003 R2/Windows Server 2003
Click the start button and select **Control Panel**.
 4. Open **Uninstall a program** (or **Add or Remove Programs**):
 - Windows 11/Windows 10/Windows 8.1/Windows 8/Windows 7/Windows Vista/Windows Server 2022/Windows Server 2019/Windows Server 2016/Windows Server 2012 R2/Windows Server 2012/Windows Server 2008 R2/Windows Server 2008
Select **Uninstall a program** in **Programs**.
 - Windows XP/Windows Server 2003 R2/Windows Server 2003
Click **Add or Remove Programs**.
 5. Select the application you want to uninstall.
You cannot uninstall the printer driver if there is any print jobs. Delete or wait to be printed the jobs before uninstalling.
 6. Uninstall the applications:
 - Windows 11/Windows 10/Windows 8.1/Windows 8/Windows 7/Windows Vista/Windows Server 2022/Windows Server 2019/Windows Server 2016/Windows Server 2012 R2/Windows Server 2012/Windows Server 2008 R2/Windows Server 2008
Click **Uninstall/Change** or **Uninstall**.
 - Windows XP/Windows Server 2003 R2/Windows Server 2003
Click **Change/Remove** or **Remove**.
- Note:**
*If the **User Account Control** window is displayed, click **Continue**.*
7. Follow the on-screen instructions.

Uninstalling Applications - Mac OS

1. Download the Uninstaller using EPSON Software Updater.
Once you have downloaded the Uninstaller, you do not need to download it again each time you uninstall the application.
2. Press the  button to turn off the printer.

3. To uninstall the printer driver, select **System Preferences** from the Apple menu > **Printers & Scanners** (or **Print & Scan, Print & Fax**), and then remove the printer from the enabled printers list.
4. Quit all running applications.
5. Select **Go > Applications > Epson Software > Uninstaller**.
6. Select the application you want to uninstall, and then click **Uninstall**.



Important:

The Uninstaller removes all drivers for Epson inkjet printers on the computer. If you use multiple Epson inkjet printers and you only want to delete some drivers, delete all of them first, and then install the necessary printer driver again.

Note:

*If you cannot find the application you want to uninstall in the application list, you cannot uninstall using the Uninstaller. In this situation, select **Go > Applications > Epson Software**, select the application you want to uninstall, and then drag it to the trash icon.*

Related Information

➔ [“Application for Updating Software and Firmware \(Epson Software Updater\)” on page 183](#)

Making Settings for Connecting to the Computer

Follow any instructions from your administrator regarding how to connect the printer.

Access the following website, and then enter the product name. Go to **Setup**, and then start setting up.

<https://epson.sn>

To configure a shared printer on the network, select a printer found on the network and begin configuration.

Checking the Printer's Network Connection Status (Network Connection Report)

You can print a network connection report to check the status between the printer and the wireless router.

1. Select  on the home screen.

To select an item, use the ▲ ▼ ◀ ▶ buttons, and then press the OK button.

2. Select **Information > When you cannot connect to the network > Connection Check**.

The connection check starts.

3. Follow the instructions on the printer's screen to print the network connection report.

If an error has occurred, contact your administrator.

Related Information

➔ [“Messages and Solutions on the Network Connection Report” on page 52](#)

Connecting a Smart Device and Printer Directly (Wi-Fi Direct)

Wi-Fi Direct (Simple AP) allows you to connect a smart device directly to the printer without a wireless router and print from the smart device.

About Wi-Fi Direct

Use this connection method when you are not using Wi-Fi at home or at the office, or when you want to connect the printer and the computer or smart device directly. In this mode, the printer acts as an wireless router and you can connect the devices to the printer without having to use a standard wireless router. However, devices directly connected to the printer cannot communicate with each other through the printer.

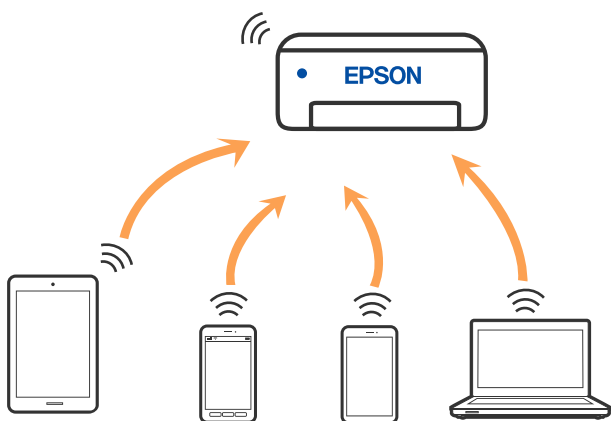

The printer can be connected by Wi-Fi or Ethernet, and Wi-Fi Direct (Simple AP) connection simultaneously. However, if you start a network connection in Wi-Fi Direct (Simple AP) connection when the printer is connected by Wi-Fi, the Wi-Fi is temporarily disconnected.

Connecting to Devices using Wi-Fi Direct

This method allows you to connect the printer directly to devices without a wireless router.

Note:

For iOS or Android users, it is convenient to set up from Epson Smart Panel.

You only need to make these settings for the printer and the device that you want to connect to once. Unless you disable Wi-Fi Direct or restore the network settings to their defaults, you do not need to make these settings again.

1. Select **Wi-Fi** on the home screen.

To select an item, use the ▲ ▼ ◀▶ buttons, and then press the OK button.

2. Select **Wi-Fi Direct**.

3. Press the OK button.
4. Select **Other Methods**.
5. Select **Other OS Devices**.
6. On the device's Wi-Fi screen, select the SSID shown on the printer's control panel, and then enter the password.

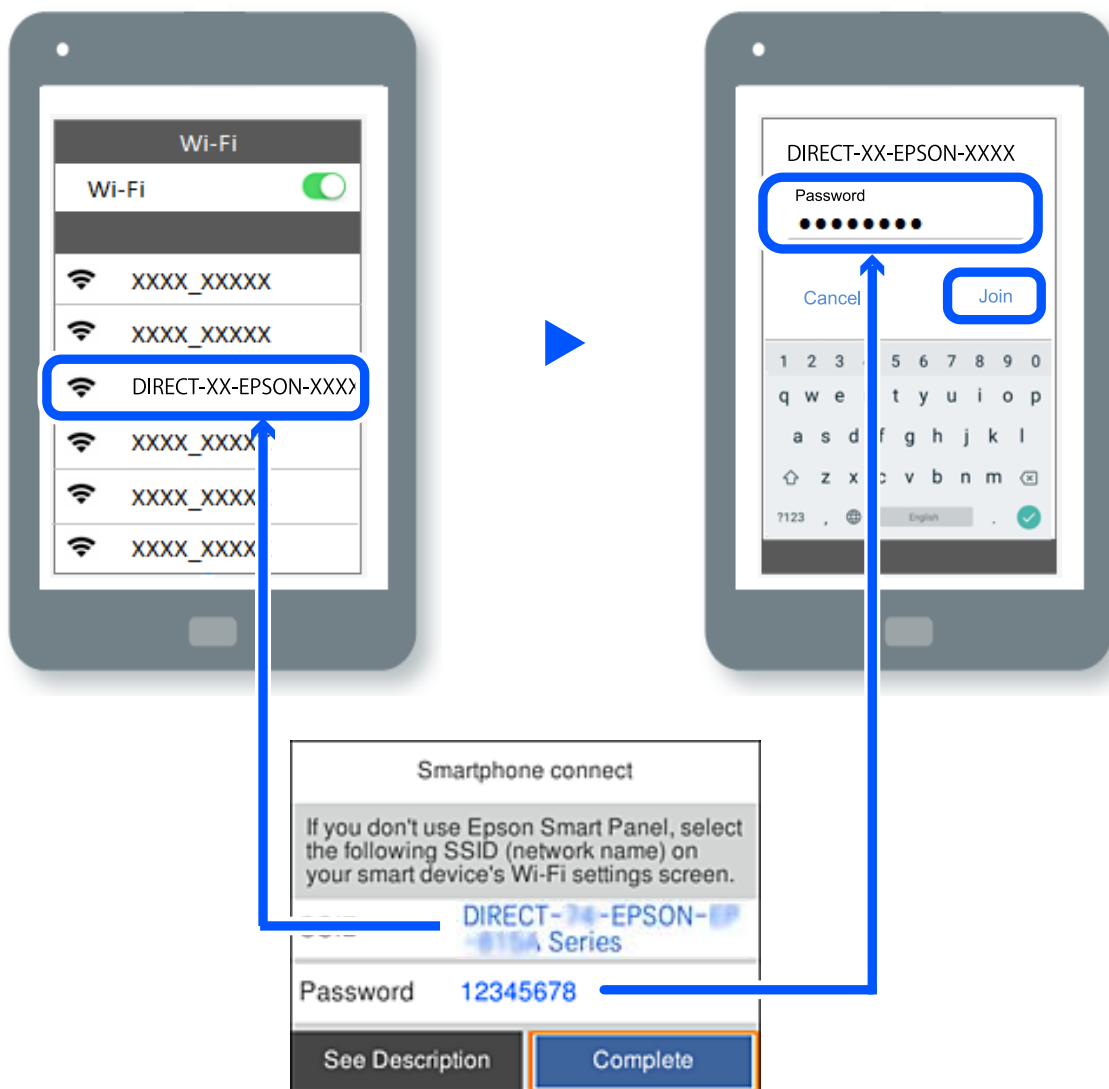

7. On the printing app screen for the device, select the printer that you want to connect to.
8. On the printer's control panel, select **Complete**.

For devices that have been connected to the printer before, select the network name (SSID) on the device's Wi-Fi screen to connect them again.

Note:

If you are using an iOS device, you can also connect by scanning the QR code with the standard iOS camera. See the link below <https://epson.sn>.

Disconnecting Wi-Fi Direct (Simple AP) Connection

Note:

When Wi-Fi Direct (Simple AP) connection is disabled, all computers and smart devices connected to the printer in Wi-Fi Direct (Simple AP) connection are disconnected. If you want to disconnect a specific device, disconnect from the device instead of the printer.

1. Select **Wi-Fi** on the printer's home screen.

To select an item, use the ▲ ▼ ◀ ▶ buttons, and then press the OK button.

2. Select **Wi-Fi Direct**.

The Wi-Fi Direct information is displayed.

3. Press the OK button.

4. Select  .

5. Select **Disable Wi-Fi Direct**.

6. Follow the on-screen instructions.

Changing the Wi-Fi Direct (Simple AP) Settings Such as the SSID

When Wi-Fi Direct (simple AP) connection is enabled, you can change the settings from **Wi-Fi > Wi-Fi Direct >**

Start Setup >  , and then the following menu items are displayed.

Change Network Name

Change the Wi-Fi Direct (simple AP) network name (SSID) used for connecting to the printer to your arbitrary name. You can set the network name (SSID) in ASCII characters that is displayed on the software keyboard on the control panel. You can enter up to 22 characters.

When changing the network name (SSID), all connected devices are disconnected. Use the new network name (SSID) if you want to re-connect the device.

Change Password

Change the Wi-Fi Direct (simple AP) password for connecting to the printer to your arbitrary value. You can set the password in ASCII characters that is displayed on the software keyboard on the control panel. You can enter 8 to 22 characters.

When changing the password, all connected devices are disconnected. Use the new password if you want to re-connect the device.

Change Frequency Range

Change the frequency range of Wi-Fi Direct used for connecting to the printer. You can select 2.4 GHz or 5 GHz.

When changing the frequency range, all connected devices are disconnected. Re-connect the device.

Note that you cannot re-connect from devices that do not support 5 GHz frequency range when changing to 5 GHz.

Disable Wi-Fi Direct

Disable Wi-Fi Direct (simple AP) settings of the printer. When disabling it, all devices connected to the printer in Wi-Fi Direct (Simple AP) connection are disconnected.

Restore Default Settings

Restore all Wi-Fi Direct (simple AP) settings to their defaults.

The Wi-Fi Direct (simple AP) connection information of the smart device saved to the printer is deleted.

Changing the Connection from Wi-Fi to USB

Follow the steps below if the Wi-Fi you are using is unstable, or if you want to change to a more stable USB connection.

1. Connect the printer to a computer using a USB cable.
2. Select a printer that is not labeled (XXXXXX) when printing using a USB connection.
Your printer name or "Network" is displayed in XXXXX depending on the operating system version.
Example of Windows 11

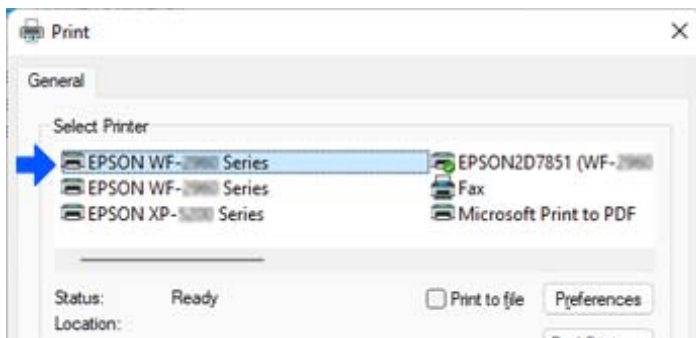

Example of Windows 10

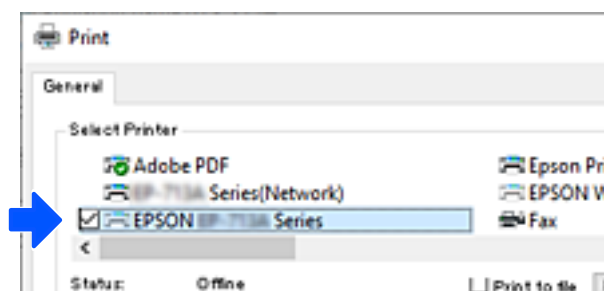

If the printer is not recognized while it is connected to the computer by a USB cable, a printer administrator may have restricted the external interface connection. Contact your administrator.

Related Information

- ➔ [“Rear” on page 23](#)
- ➔ [“Restricting USB Connections” on page 235](#)

Transporting and Storing the Printer

When you need to store the printer or transport it when moving or for repairs, follow the steps below to pack the printer.

 **Caution:**

- When carrying the printer, lift it using a stable position. Lifting the printer using an unstable position may result in injury.
- Because this printer is heavy, it should always be carried by two or more people when unpacking and transporting.
- When lifting the printer, two or more people should assume the correct positions as shown below. Uninstall the optional paper cassette unit if it is installed. If you lift the printer holding other positions, the printer may fall or you may trap your fingers when placing the printer.

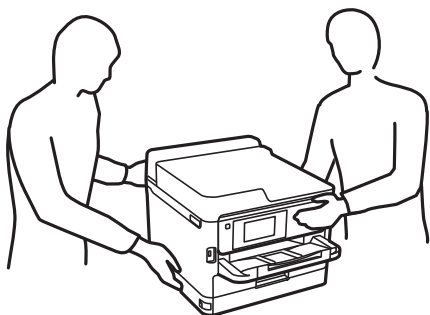

- When carrying the printer, do not tilt it more than 10 degrees; otherwise the printer may fall.

 **Important:**

- When storing or transporting the printer, avoid tilting it, placing it vertically, or turning it upside down; otherwise ink may leak.
- Leave the ink supply unit installed. Removing the ink supply unit can dry out the print head and may prevent the printer from printing.

1. Turn off the printer by pressing the  button.
2. Make sure the power light turns off, and then unplug the power cord.

 **Important:**

Unplug the power cord when the power light is off. Otherwise, the print head does not return to the home position causing the ink to dry, and printing may become impossible.

3. Disconnect all cables such as the power cord and USB cable.
4. If the printer supports external storage devices, make sure they are not connected.
5. Remove all of the paper from the printer.

6. Open the printer cover. Secure the print head to the case with tape.

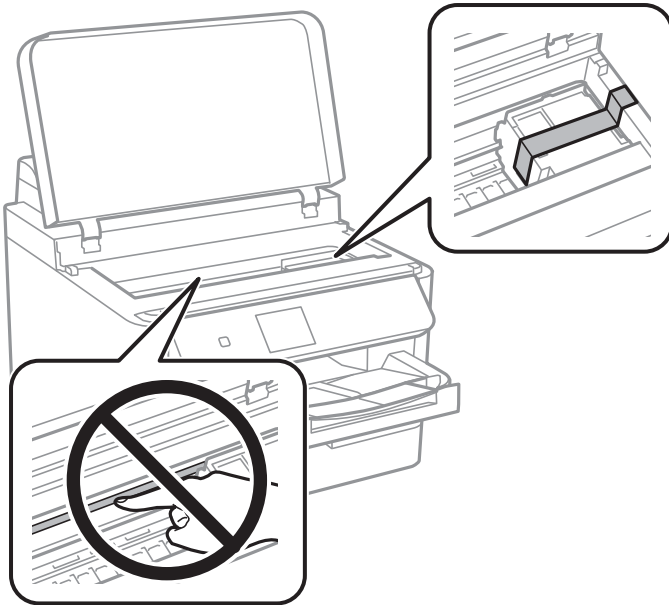

7. Close the printer cover.

8. Open the ink cover.

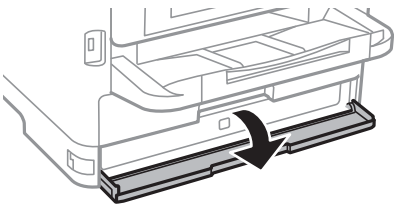

If the ink cover is locked, you cannot open it. Release the cover lock.

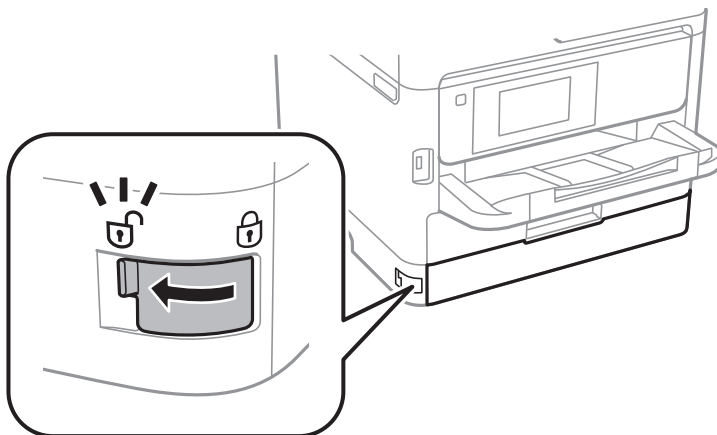

- Secure the ink tray by attaching the supplied protective material with tape so that the tray can not open.

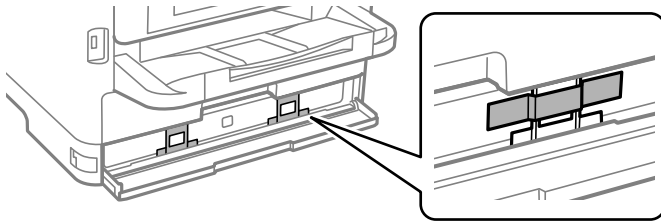

- Close the ink cover.
- Uninstall the optional paper cassette unit if it is installed.

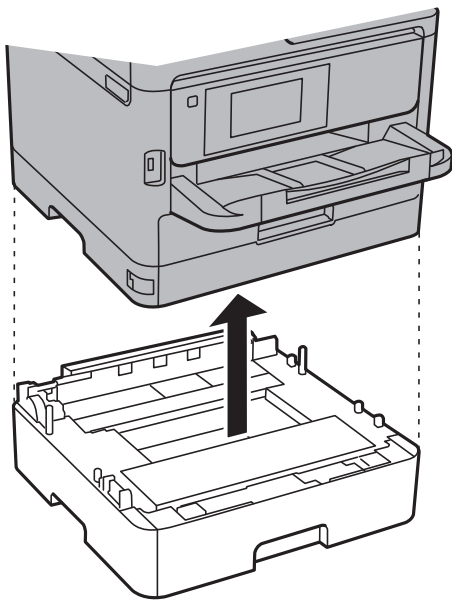

- Prepare to pack the printer as shown below.

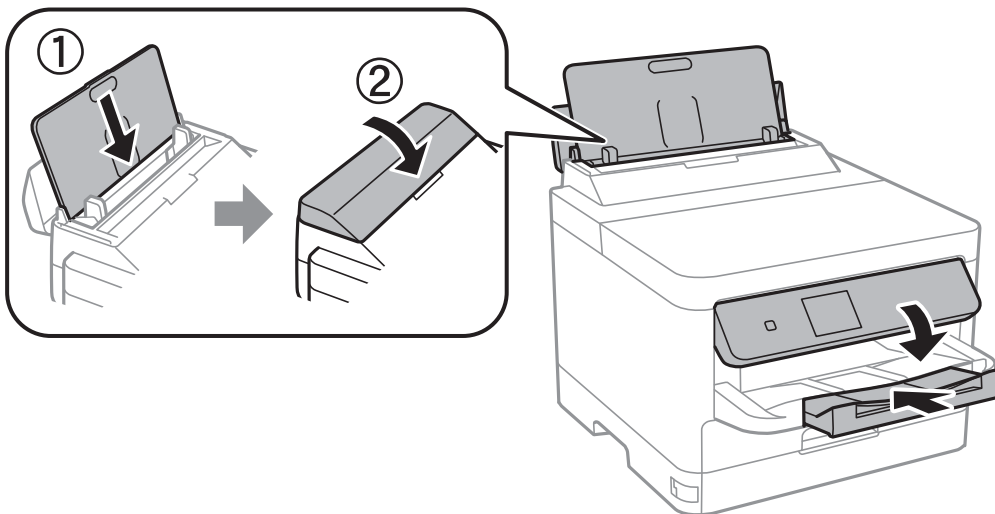

13. Remove the output tray from the printer.

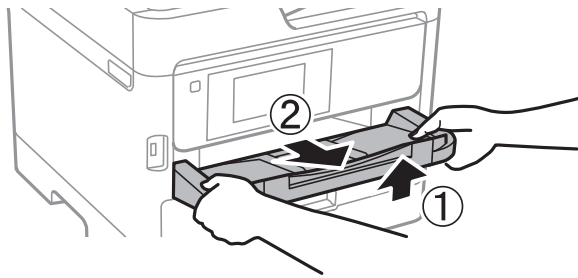

14. Pack the printer in its box, using the protective materials.

When you use the printer again, make sure you remove the tape securing the print head and the protective material attached on the ink tray. If print quality has declined the next time you print, clean and align the print head.

Related Information

- ➔ [“Checking and Cleaning the Print Head” on page 124](#)
- ➔ [“Aligning the Print Head” on page 125](#)

Solving Problems

Problem Solving.	147
Cannot Print.	149
Print Quality is Poor.	154
A Message is Displayed on the LCD Screen.	160
Paper Gets Jammed.	162
It is Time to Replace Ink Supply Units.	163
It is Time to Replace the Maintenance Box.	164
It is Time to Replace the Pickup Rollers.	165
Cannot Operate the Printer as Expected.	166
Cannot Solve Problem.	170

Problem Solving

If any problems occur, check the following in order to find the cause.

Check the printer's error status.

Check if there is a problem with the printer itself.

Check Point	Solution
Is there an error on the printer?	If an error message is displayed on the LCD screen, follow the message to solve the problem. If you cannot solve it due to limited access controls, contact the administrator.
	If the paper is jammed, check the LCD screen to see where the paper is jammed, and then follow the instructions to remove it. For precautions, see the applicable descriptions in this manual.
	If a message for replacing consumables is displayed, follow the on-screen instructions to replace them. For handling precautions, see the applicable descriptions in this manual.
Are there any problems with the cables or the printer's appearance?	If the covers are not closed properly, close them. If the cables are about to disconnect, insert them firmly.
Is the power turned off?	If the power is off, press the  button to turn it on.

Related Information

- ➔ [“A Message is Displayed on the LCD Screen” on page 160](#)
- ➔ [“Paper Gets Jammed” on page 162](#)
- ➔ [“It is Time to Replace Ink Supply Units” on page 163](#)
- ➔ [“It is Time to Replace the Maintenance Box” on page 164](#)
- ➔ [“It is Time to Replace the Pickup Rollers” on page 165](#)

Check the printer connection.

Check if there is a problem with the printer connection.

Check point	Solution
Is the printer connected to the network properly?	Run a network connection check to check the network connection. On the LCD screen, select  > How To... > When you cannot connect to the network . Print the network connection report, and then ask the administrator to solve the problem if there is a connection problem.
Is the printer driver installed on your computer?	You can check if the printer driver is installed by checking Settings > Devices > Printers on your computer. See the related information for details.

Check point	Solution
Is the printer's information displayed on your computer?	You can use Epson Status Monitor 3 to check the connection status between the computer and the printer. See the related information for details.
	If you cannot check the printer status, the correct port may not be selected. When you connect to the printer on the network, we recommend that you select EpsonNet Print Port . If EpsonNet Print Port is not available, re-install the printer driver.
Has the wireless LAN (Wi-Fi) connection been interrupted or is it unable to connect when you are using a USB 3.0 device on your computer?	When you connect a device to the USB 3.0 port on a Mac, radio frequency interference may occur. Try the following. <ul style="list-style-type: none"> <input type="checkbox"/> Place the device that is connected to the USB 3.0 port further away from the computer. <input type="checkbox"/> Turn off any unused USB 3.0 devices or connect them only when necessary. <input type="checkbox"/> Connect to the SSID for the 5 GHz range.
Can your computer or smart device be connected to the network?	Check if you can view the website on your computer or smart device (data communication turned off). If you cannot view it, there is a problem with the network. Ask the administrator to solve the problem.

Related Information

- ➔ [“Checking the Printer's Network Connection Status \(Network Connection Report\)” on page 137](#)
- ➔ [“There is a problem with the printer's status.” on page 150](#)
- ➔ [“The printer port is not set correctly.” on page 150](#)
- ➔ [“The Printer Cannot Connect by USB” on page 152](#)
- ➔ [“Installing the Applications Separately” on page 131](#)

Check the printer settings.

Check the printer settings. Printers managed by the administrator may be restricted so that the printer settings cannot be changed. If you cannot perform operations, contact the administrator.

Check point	Solution
Printing does not start.	There may still be data remaining in the printer. Open the printer queue, and then check the status of the print job. If it is pending with an error, clear the error and restart it or delete the job with the error, and then the rest of the data will start printing.
	If the default printer is pending or offline, set it to online in the printer settings on the Windows computer.
	Select the printer and port to output correctly.
The menu that you want to use is not displayed.	Access control has been set by your administrator. Contact the administrator for the information required to use the missing menu.
	Some features require a separate contract to use. Contact your administrator to check if the feature is available for your printer.

Related Information

- ➔ [“There is still a job waiting to be printed.” on page 150](#)
- ➔ [“The printer is pending or offline.” on page 149](#)
- ➔ [“Using Port for the Printer” on page 199](#)

Cannot Print

The Application or Printer Driver do not Work Properly

Cannot Print Even Though a Connection has been Established (Windows)

The following causes can be considered.

■ The printer is pending or offline.

Solutions

Click **Print Queue** on the printer driver's **Maintenance** tab.

If the printer is offline or pending, clear the offline or pending setting from the **Printer** menu.

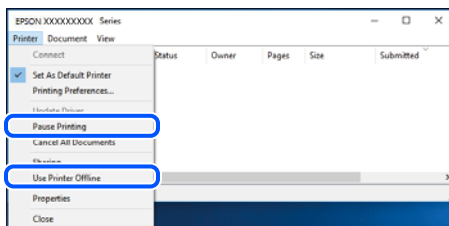

■ There is a problem with the software or data.

Solutions

- Make sure that a genuine Epson printer driver (EPSON XXXXX) is installed. If a genuine Epson printer driver is not installed, the available functions are limited. We recommend using a genuine Epson printer driver.
- If you are printing a large data size image, the computer may run out of memory. Print the image at a lower resolution or a smaller size.
- If you have tried all of the solutions and have not solved the problem, try uninstalling and then reinstalling the printer driver.
- You may be able to clear the problem by updating the software to the latest version. To check the software status, use the software update tool.

- ➔ [“Checking if a genuine Epson printer driver is installed - Windows” on page 132](#)
- ➔ [“Checking if a genuine Epson printer driver is installed - Mac OS” on page 134](#)
- ➔ [“Installing or Uninstalling Applications Separately” on page 131](#)

There is a problem with the printer's status.

Solutions

Click **EPSON Status Monitor 3** on the printer driver's **Maintenance** tab, and then check the printer status. If **EPSON Status Monitor 3** is disabled, click **Extended Settings** on the **Maintenance** tab, and then select **Enable EPSON Status Monitor 3**.

There is still a job waiting to be printed.

Solutions

Click **Print Queue** on the printer driver's **Maintenance** tab. If unnecessary data remains, select **Cancel all documents** from the **Printer** menu.

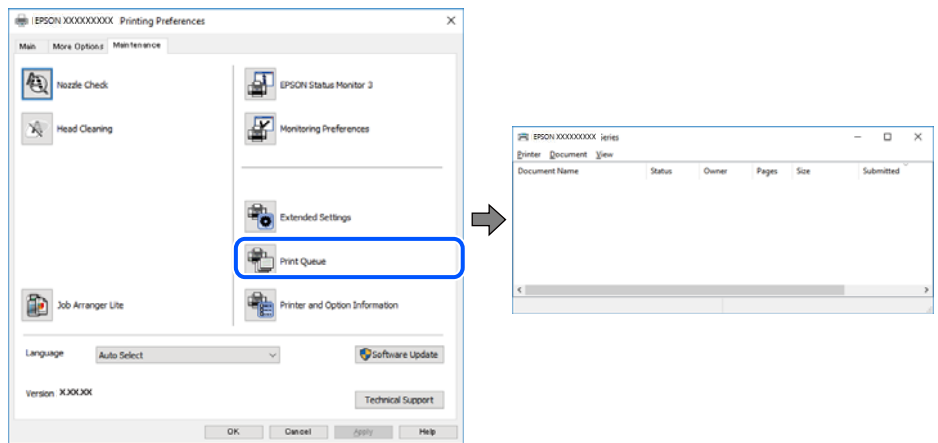

The printer is not selected as the default printer.

Solutions

Right-click the printer icon in **Control Panel > View devices and printers** (or **Printers, Printers and Faxes**) and click **Set as default printer**.

Note:

If there are multiple printer icons, see the following to select the correct printer.

Example)

USB connection: EPSON XXXX Series

Network connection: EPSON XXXX Series (network)

If you install the printer driver multiple times, copies of the printer driver may be created. If copies such as "EPSON XXXX Series (copy 1)" are created, right-click the copied driver icon, and then click **Remove Device**.

The printer port is not set correctly.

Solutions

Click **Print Queue** on the printer driver's **Maintenance** tab.

Make sure the printer port is set correctly as shown below in **Property > Port** from the **Printer** menu.

USB connection: **USBXXX**, Network connection: **EpsonNet Print Port**

If you cannot change the port, select **Run as administrator** on the **Printer** menu. If **Run as administrator** is not displayed, contact your system administrator.

Printer Does Not Print While Using PostScript Printer Driver (Windows)

The following causes can be considered.

■ The Printing Language setting needs to be changed.

Solutions

Set the **Printing Language** setting to **Auto** or **PS** on the control panel.

■ A large number of jobs have been sent.

Solutions

In Windows, if a large number of jobs are sent, the printer may not print. Select **Print directly to the printer** on the **Advanced** tab in the printer properties.

Cannot Print Even Though a Connection has been Established (Mac OS)

The following causes can be considered.

■ There is a problem with the software or data.

Solutions

- Make sure that a genuine Epson printer driver (EPSON XXXXX) is installed. If a genuine Epson printer driver is not installed, the available functions are limited. We recommend using a genuine Epson printer driver.
- If you are printing a large data size image, the computer may run out of memory. Print the image at a lower resolution or a smaller size.
- If you have tried all of the solutions and have not solved the problem, try uninstalling and then reinstalling the printer driver.
- You may be able to clear the problem by updating the software to the latest version. To check the software status, use the software update tool.

➔ [“Checking if a genuine Epson printer driver is installed - Windows” on page 132](#)

➔ [“Checking if a genuine Epson printer driver is installed - Mac OS” on page 134](#)

➔ [“Installing or Uninstalling Applications Separately” on page 131](#)

■ There is a problem with the status of the printer.

Solutions

Make sure the printer status is not **Pause**.

Select **System Preferences** from the **Apple** menu > **Printers & Scanners** (or **Print & Scan**, **Print & Fax**), and then double-click the printer. If the printer is paused, click **Resume**.

Printer Does Not Print While Using PostScript Printer Driver (Mac OS)

■ The Printing Language setting needs to be changed.

Solutions

Set the **Printing Language** setting to **Auto** or **PS** on the control panel.

Cannot Print Even Though a Connection has been Established (iOS)

The following causes can be considered.

■ Paper Setup Auto Display is disabled.

Solutions

Enable **Paper Setup Auto Display** in the following menu.

Settings > General Settings > Printer Settings > Paper Source Settings > Paper Setup Auto Display

■ AirPrint is disabled.

Solutions

Enable the AirPrint setting on Web Config.

➔ [“Application for Configuring Printer Operations \(Web Config\)” on page 182](#)

The Printer Cannot Connect by USB

The following causes can be considered.

■ The USB cable is not plugged into the USB inlet correctly.

Solutions

Connect the USB cable securely to the printer and the computer.

■ There is a problem with the USB hub.

Solutions

If you are using a USB hub, try to connect the printer directly to the computer.

■ There is a problem with the USB cable or the USB inlet.

Solutions

If the USB cable cannot be recognized, change the port, or change the USB cable.

■ The printer is connected to a SuperSpeed USB port.

Solutions

If you connect the printer to a SuperSpeed USB port using a USB 2.0 cable, a communication error may occur on some computers. In this case, re-connect the printer using one of the following methods.

- Use a USB 3.0 cable (Supported models only).
- Connect to a Hi-Speed USB port on the computer.
- Connect to a SuperSpeed USB port other than the port that generated the communication error.

➔ [“Interface Specifications” on page 200](#)

Paper Does Not Feed or Eject Correctly

Points to Check

Check the following items, and then try the solutions according to the problems.

■ The installation location is inappropriate.

Solutions

Place the printer on a flat surface and operate in the recommended environmental conditions.

➔ [“Environmental Specifications” on page 205](#)

■ Unsupported paper is being used.

Solutions

Use paper supported by this printer.

➔ [“Available Paper and Capacities” on page 173](#)

➔ [“Unavailable Paper Types” on page 176](#)

■ Paper handling is inappropriate.

Solutions

Follow paper handling precautions.

➔ [“Paper Handling Precautions” on page 75](#)

■ Too many sheets are loaded in the printer.

Solutions

Do not load more than the maximum number of sheets specified for the paper. For plain paper, do not load above the line indicated by the triangle symbol on the edge guide.

➔ [“Available Paper and Capacities” on page 173](#)

■ The paper settings on the printer are incorrect.

Solutions

Make sure the paper size and paper type settings match the actual paper size and paper type loaded in the printer.

➔ [“Paper Size and Type Settings” on page 75](#)

Paper Feeds at a Slant

The following causes can be considered.

■ **The paper is loaded incorrectly.**

Solutions

Load paper in the correct direction, and slide the edge guide against the edge of the paper.

➔ [“Loading Paper” on page 77](#)

Several Sheets of Paper are Fed at a Time

The following causes can be considered.

■ **The paper is moist or damp.**

Solutions

Load new paper.

■ **Static electricity is causing sheets of paper to stick to each other.**

Solutions

Fan the paper before loading. If the paper still does not feed, load one sheet of paper at a time.

Paper Out Error Occurs

■ **Paper is not loaded in the center of the paper tray.**

Solutions

When a paper out error occurs although paper is loaded in the paper tray, reload paper in the center of the paper tray.

Paper Does Not Feed from the Paper Cassette Units

■ **Settings for optional items have not been made in the printer driver.**

Solutions

You need to make settings in the printer driver.

➔ [“Setting Available Optional Items” on page 57](#)

Print Quality is Poor

Banding Appears in Printouts



■ **The print head nozzles may be clogged.**

Solutions

Use the **Print Quality Adjustment** feature. If you have not used the printer for a long time, the print head nozzles may be clogged and ink drops may not be discharged.

➔ [“Adjusting the Print Quality” on page 123](#)

Black or Gray Banding Appears at Intervals of Approximately 3.3 cm



The following causes can be considered.

■ **The paper type setting does not match the paper loaded.**

Solutions

Select the appropriate paper type setting for the type of paper loaded in the printer.

➔ [“List of Paper Type” on page 76](#)

■ **The print quality is set to low.**

Solutions

When printing on plain paper, print using a higher quality setting.

Windows

Select **High** from **Quality** on the printer driver's **Main** tab.

Mac OS

Select **Fine** as **Print Quality** from the print dialog's **Print Settings** menu.

■ **The print head position is out of alignment.**

Solutions

Align the print head using the **Print Quality Adjustment** feature.

Vertical Banding or Misalignment

enthalten alle
Aufdruck. W
5008 "Regel

The following causes can be considered. Check the causes and follow the solutions in order from the top.

■ The print head position is out of alignment.

Solutions

Align the print head using the **Print Quality Adjustment** feature.

■ The bidirectional printing setting is enabled.

Solutions

If print quality does not improve even after aligning the print head, disable the bidirectional setting.

During bidirectional (or high speed) printing, the print head prints while moving in both directions, and vertical lines may be misaligned. Disabling this setting may slow down printing speed but improve print quality.

Windows

Clear **Bidirectional Printing** on the printer driver's **More Options** tab.

Mac OS

Select **System Preferences** from the Apple menu > **Printers & Scanners** (or **Print & Scan**, **Print & Fax**), and then select the printer. Click **Options & Supplies** > **Options** (or **Driver**). Select **Off** as the **Bidirectional Printing** setting.

Printout Comes Out as a Blank Sheet

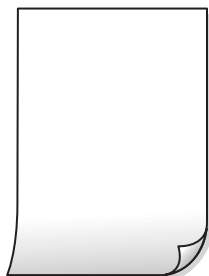

■ The print head nozzles may be clogged.

Solutions

Use the **Print Quality Adjustment** feature. If you have not used the printer for a long time, the print head nozzles may be clogged and ink drops may not be discharged.

➔ [“Adjusting the Print Quality” on page 123](#)

■ The print settings and the paper size loaded in the printer are different.

Solutions

Change the print settings according to the paper size loaded in the printer. Load paper in the printer that matches the print settings.

■ **Multiple sheets of paper are fed into the printer at the same time.**

Solutions

See the following to prevent multiple sheets of paper being fed into the printer at the same time.

➔ [“Several Sheets of Paper are Fed at a Time” on page 154](#)

Paper Is Smearred or Scuffed



The following causes can be considered.

■ **Paper is loaded incorrectly.**

Solutions

When horizontal banding (perpendicular to the printing direction) appears, or the top or bottom of the paper is smearred, load paper in the correct direction and slide the edge guides to the edges of the paper.

■ **The paper path is smearred.**

Solutions

When vertical banding (horizontal to the printing direction) appears, or the paper is smearred, clean the paper path.

➔ [“Cleaning the Paper Path for Ink Smears” on page 126](#)

■ **The paper is curled.**

Solutions

Place the paper on a flat surface to check if it is curled. If it is, flatten it.

■ **The print head is rubbing the surface of the paper.**

Solutions

When printing on thick paper, the print head is close to the printing surface and the paper may be scuffed. In this case, enable the reduce scuff setting. If you enable this setting, print quality may decline or printing may slow down.

Control panel

Select **Settings > General Settings > Printer Settings**, and then enable **Thick Paper**.

Windows

Click **Extended Settings** on the printer driver's **Maintenance** tab, and then select **Thick Paper and Envelopes**.

❑ Mac OS

Select **System Preferences** from the Apple menu > **Printers & Scanners** (or **Print & Scan, Print & Fax**), and then select the printer. Click **Options & Supplies > Options** (or **Driver**). Select **On** as the **Thick paper and envelopes** setting.

■ **The back of the paper was printed before the side that had already been printed was dry.**

Solutions

When performing manual 2-sided printing, make sure that the ink is completely dry before reloading the paper.

■ **When printing using automatic 2-sided printing, the print density is too high and the drying time is too short.**

Solutions

When using the automatic 2-sided printing feature and printing high density data such as images and graphs, set the print density to lower and the drying time to longer.

➔ [“Printing on 2-Sides” on page 86](#)

The Position, Size, or Margins of the Printout Are Incorrect



The following causes can be considered.

■ **The paper is loaded incorrectly.**

Solutions

Load paper in the correct direction, and slide the edge guide against the edge of the paper.

➔ [“Loading Paper” on page 77](#)

■ **The size of the paper is set incorrectly.**

Solutions

Select the appropriate paper size setting.

■ **The margin setting in the application software is not within the print area.**

Solutions

Adjust the margin setting in the application so that it falls within the printable area.

- Mac OS

Clear **Mirror Image** from the print dialog's **Print Settings** menu.

Mosaic-Like Patterns in the Prints



■ Images or photos with a low resolution were printed.

Solutions

When printing images or photos, print using high-resolution data. Images on web sites are often low resolution although they look good enough on the display, and so print quality may decline.

Printer Does Not Print Correctly While Using PostScript Printer Driver

The following causes can be considered.

■ There is a problem with the data.

Solutions

- If the file is created in an application that allows you to change the data format, such as Adobe Photoshop, make sure that the settings in the application match the settings in the printer driver.
- EPS files made in binary format may not be printed correctly. Set the format to ASCII when making EPS files in an application.
- For Windows, the printer cannot print binary data when it is connected to the computer using a USB interface. Set the **Output Protocol** setting on the **Device Settings** tab in the printer properties to ASCII or TBCP.
- For Windows, select the appropriate substitution fonts on the **Device Settings** tab in the printer properties.

Print Quality Is Poor While Using PostScript Printer Driver

■ Color settings have not been made.

Solutions

You cannot make color settings on the **Paper/Quality** tab in the printer driver. Click **Advanced**, and then set the **Color Mode** setting.

A Message is Displayed on the LCD Screen

If an error message is displayed on the LCD screen, follow the on-screen instructions or the solutions below to solve the problem.

Error Messages	Solutions
<p>Printer Error</p> <p>Turn on the printer again. See your documentation for more details.</p>	<ul style="list-style-type: none"> ❑ Remove any paper or protective material in the printer and the paper cassette. If the error message is still displayed after turning the power off and on again, contact Epson support. ❑ When the following error codes are displayed, check the paper for the maximum number of sheets that can be loaded in each paper source. 000181, 000184
<p>Paper out in XX.</p>	<p>Load paper, and then insert the paper cassette all the way.</p>
<p>Too many paper cassette units are installed. Turn the power off and uninstall the extra units. See your documentation for details.</p>	<p>You can install up to three optional paper cassette unit. For other optional paper cassette units, uninstall them by following the reverse steps to installation.</p>
<p>Cannot print because XX is out of order. You can print from another cassette.</p>	<p>Turn the power off and on again, and then reinsert the paper cassette. If the error message is still displayed, contact Epson support or an authorised Epson service provider to request repairs.</p>
<p>The pickup roller in XX is nearing the end of its service life.</p>	<p>The pickup rollers need to be replaced periodically. Paper is not fed correctly from the paper cassette when it is time for replacement. Prepare new pickup rollers.</p>
<p>The pickup roller in XX has reached the end of its service life.</p>	<p>Replace the pickup rollers. After replacing the rollers, select Settings > Maintenance > Pickup roller information > Reset Counter, and then select the paper cassette for which you replaced the pickup rollers.</p>
<p>You need to replace Ink Supply Unit.</p>	<p>To ensure you receive premium print quality and to help protect your print head, a variable ink safety reserve remains in the ink supply unit when your printer indicates it is time to replace the ink supply unit. Replace with a new Ink supply unit.</p>
<p>Paper Setup Auto Display is set to Off. Some features may not be available. For details, see your documentation.</p>	<p>If Paper Setup Auto Display is disabled, you cannot use AirPrint.</p>
<p>The combination of the IP address and the subnet mask is invalid. See your documentation for more details.</p>	<p>Contact your printer administrator.</p>
<p>To use cloud services, update the root certificate from the Epson Web Config utility.</p>	<p>Contact your printer administrator.</p>
<p>Check that the printer driver is installed on the computer and that the port settings for the printer are correct.</p>	<p>Make sure the printer port is selected correctly in Property > Port from the Printer menu as follows.</p> <p>Select "USBXXX" for a USB connection, or "EpsonNet Print Port" for a network connection.</p>
<p>Paper feed error. Remove Cassette 1, make sure there is no jammed paper remaining in the printer, and reload the paper.</p>	<p>Pull out paper cassette1, remove the jammed paper from inside the printer, and then re-insert the paper cassette.</p> <p>Even if you cannot feed the paper, check the position of the pickup roller lock. If the position is wrong, push the pickup roller lock with your finger to correct the position. See the Web Movie Manuals for the position of the pickup roller lock.</p> <p>https://support.epson.net/publist/vlink.php?code=NPD7274</p> <p>For users in China, access the following website.</p> <p>https://support.epson.net/publist/vlink.php?code=NPD7275</p>

Error Messages	Solutions
Recovery Mode Update Firmware	Contact your printer administrator.

Paper Gets Jammed

Check the error displayed on the control panel and follow the instructions to remove the jammed paper including any torn pieces. The LCD screen displays an animation that shows you how to remove jammed paper.



Caution:

Never touch the buttons on the control panel while your hand is inside the printer. If the printer starts operating, it could cause an injury. Be careful not to touch the protruding parts to avoid injury.



Important:

Remove the jammed paper carefully. Removing the paper vigorously may cause damage to the printer.

Preventing Paper Jams

Check the following if paper jams occur frequently.

- Place the printer on a flat surface and operate in the recommended environmental conditions.
[“Environmental Specifications” on page 205](#)
- Use the paper supported by this printer.
[“Available Paper and Capacities” on page 173](#)
- Follow paper handling precautions.
[“Paper Handling Precautions” on page 75](#)
- Load paper in the correct direction, and slide the edge guide against the edge of the paper.
[“Loading Paper” on page 77](#)
- Do not load more than the maximum number of sheets specified for paper.
- Load one sheet of paper at a time if you have loaded several sheets of paper.
- Make sure the paper size and paper type settings match the actual paper size and paper type loaded in the printer.
[“List of Paper Type” on page 76](#)

It is Time to Replace Ink Supply Units

Ink Supply Unit Handling Precautions

Storing precautions for ink

- Keep the ink supply units out of direct sunlight.
- Do not store the ink supply units in high or freezing temperatures.
- Epson recommends using the ink supply unit before the date printed on the package.
- For best results, store ink supply unit packages with their bottom down.
- After bringing an ink supply unit inside from a cold storage site, allow it to warm up at room temperature for at least 12 hours before using it.
- Do not drop or knock the ink supply unit against hard objects; otherwise, the ink may leak.

Handling precautions for replacing ink

- Do not touch the sections shown in the illustration. Doing so may prevent normal operation and printing.

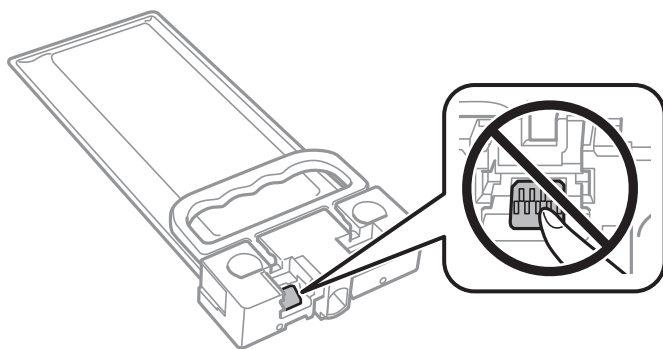

- Do not turn off the printer during ink charging. If the ink charging is incomplete, you may not be able to print.
- Do not leave the printer with the ink supply unit removed; otherwise, ink remaining in the print head nozzles may dry out and you may not be able to print.
- If you need to remove an ink supply unit temporarily, make sure you protect the ink supply area from dirt and dust. Store the ink supply unit in the same environment as the printer. Because the ink supply port is equipped with a valve designed to contain the release of excess ink, there is no need to supply your own covers or plugs.
- Removed ink supply unit may have ink around the ink supply port, so be careful not to get any ink on the surrounding area when removing the ink supply unit.
- This printer uses an ink supply unit equipped with a green chip that monitors information such as the amount of remaining ink. This means that even if the ink supply unit is removed from the printer before it is expended, you can still use the ink supply unit after reinserting it back into the printer.
- To ensure you receive premium print quality and to help protect your print head, a variable ink safety reserve remains in the ink supply unit when your printer indicates to replace the ink supply unit. The yields quoted for you do not include this reserve.
- Do not disassemble or remodel the ink supply unit, otherwise you may not be able to print normally.
- You cannot use the ink supply unit that came with the printer for the replacement.

- ❑ If the ink supply unit has changed shape due to being dropped and so on, fix the shape before inserting it in the printer; otherwise, it may not be set correctly.

Consumption of ink

- ❑ To maintain optimum print head performance, some ink is consumed from the ink supply unit during maintenance operations such as print head cleaning. Ink may also be consumed when you turn the printer on.
- ❑ The ink in the ink supply unit supplied with your printer is partly used during initial setup. In order to produce high quality printouts, the print head in your printer will be fully charged with ink. This one-off process consumes a quantity of ink and therefore the ink supply unit may print fewer pages compared to subsequent ink supply unit.
- ❑ Quoted yields may vary depending on the images that you are printing, the paper type that you are using, the frequency of your prints and environmental conditions such as temperature.
- ❑ For best results, use up ink supply unit within two years of installation.

Replacing Ink Supply Units

When a message is displayed prompting you to replace the ink supply units, select **How To...** and then view the animations displayed on the control panel to learn how to replace the ink supply units.

Related Information

- ➔ [“Ink Supply Unit Codes” on page 176](#)
- ➔ [“Ink Supply Unit Handling Precautions” on page 163](#)

It is Time to Replace the Maintenance Box

Maintenance Box Handling Precautions

Read the following instructions before replacing the maintenance box.

- ❑ Do not touch the green chip on the side of the maintenance box. Doing so may prevent normal operation and printing.
- ❑ Do not drop the maintenance box or subject it to strong shocks.
- ❑ Do not replace the maintenance box during printing; otherwise, ink may leak.
- ❑ Do not remove the maintenance box and its cover except when replacing the maintenance box; otherwise ink may leak.
- ❑ Do not tilt the used maintenance box until after it is sealed in the plastic bag; otherwise ink may leak.
- ❑ Do not touch the openings in the maintenance box as you may get smeared with ink.
- ❑ Do not reuse a maintenance box which has been removed and left detached for a long period. Ink inside the box will have solidified and no more ink can be absorbed.
- ❑ Keep the maintenance box out of direct sunlight.
- ❑ Do not store the maintenance box in high or freezing temperatures.

Replacing a Maintenance Box

In some print cycles a very small amount of surplus ink may be collected in the maintenance box. To prevent ink leakage from the maintenance box, the printer is designed to stop printing when the absorbing capacity of the maintenance box has reached its limit. Whether and how often this is required will vary according to the number of pages you print, the type of material that you print and the number of cleaning cycles that the printer performs.

When a message is displayed prompting you to replace the maintenance box, refer to the animations displayed on the control panel. The need for replacement of the box does not mean that your printer has ceased to operate in accordance with its specifications. The Epson warranty does not cover the cost of this replacement. It is a user-serviceable part.

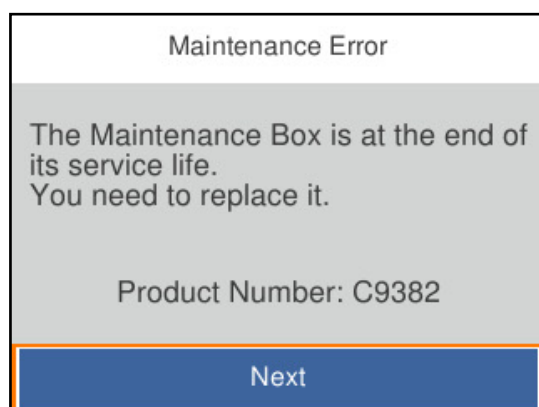

Note:

- ❑ When it is full, you cannot print and clean the print head until the maintenance box is replaced to avoid ink leakage.

Related Information

- ➔ “Maintenance Box Code” on page 177
- ➔ “Maintenance Box Handling Precautions” on page 164

It is Time to Replace the Pickup Rollers

Replacing Pickup Rollers for the Paper Cassette Unit

See the slip sheet supplied with the pickup roller's carton box to replace the pickup rollers for the paper cassette unit.

- ▶ You can also watch the procedure in the Web Movie Manuals. Access the following website.

<https://support.epson.net/publist/vlink.php?code=NPD6984>

For users in China, access the following website.

<https://support.epson.net/publist/vlink.php?code=NPD7069>

Related Information

- ➔ “Pickup Rollers Code” on page 177

Replacing Pickup Rollers for the Optional Paper Cassette Units

See the slip sheet supplied with the pickup roller's carton box to replace the pickup rollers for the optional paper cassette units.

 You can also watch the procedure in the Web Movie Manuals. Access the following website.

<https://support.epson.net/publist/vlink.php?code=NPD6986>

For users in China, access the following website.

<https://support.epson.net/publist/vlink.php?code=NPD7071>

Related Information

➔ [“Pickup Rollers Code” on page 177](#)

Cannot Operate the Printer as Expected

The Printer Does Not Turn On or Off

Power Does Not Turn On

The following causes can be considered.

 The power cord is not plugged in properly to the electrical outlet.

Solutions

Make sure the power cord is securely plugged in.

 The  button was not pressed for long enough.



Solutions

Hold down the  button for a little longer.

Power Does Not Turn Off

 The  button was not pressed for long enough.

Solutions

Hold down the  button for a little longer. If you still cannot turn off the printer, unplug the power cord. To prevent the print head from drying out, turn the printer back on and turn it off by pressing the  button.

Power Turns Off Automatically

■ The Power Off Settings or Power Off Timer feature is enabled.

Solutions

- Select **Settings > General Settings > Basic Settings > Power Off Settings**, and then disable the **Power Off If Inactive** and **Power Off If Disconnected** settings.
- Select **Settings > General Settings > Basic Settings**, and then disable the **Power Off Timer** Setting.

Note:

Your product may have the **Power Off Settings** or **Power Off Timer** feature depending on the location of purchase.

Operations are Slow

Printing Is Too Slow

The following causes can be considered.

■ Unnecessary applications are running.

Solutions

Close any unnecessary applications on your computer or smart device.

■ The print quality is set to high.

Solutions

Lower the quality setting.

■ Bidirectional printing is disabled.

Solutions

Enable the bidirectional (or high speed) setting. When this setting is enabled, the print head prints while moving in both directions, and the printing speed increases.

- Windows

Select **Bidirectional Printing** on the printer driver's **More Options** tab.

- Mac OS

Select **System Preferences** from the Apple menu > **Printers & Scanners** (or **Print & Scan, Print & Fax**), and then select the printer. Click **Options & Supplies > Options** (or **Driver**). Select **On** as the **Bidirectional Printing** setting.

■ Quiet Mode is enabled.

Solutions

Disable **Quiet Mode**. The printing speed slows down when the printer is running in **Quiet Mode**.

- Control panel

Select  on the home screen, and then select **Off**.

Windows

Select **Off** as the **Quiet Mode** setting on the printer driver's **Main** tab.

Mac OS

Select **System Preferences** from the Apple menu > **Printers & Scanners** (or **Print & Scan, Print & Fax**), and then select the printer. Click **Options & Supplies > Options** (or **Driver**). Select **Off** as the **Quiet Mode** setting.

Drying takes a while for 2-sided printing.

Solutions

For 2-sided printing, one side of paper is printed and dried, and then the other side is printed. Because the drying time differs depending on the environment, such as temperature or humidity, or the print data, the printing speed may be slower.

Printing Slows Down Dramatically During Continuous Printing

The function that prevents the printer mechanism from overheating and being damaged is operating.

Solutions

You can continue printing. To return to normal printing speed, leave the printer idle for at least 30 minutes. Printing speed does not return to normal if the power is off.

Printing Is Too Slow While Using PostScript Printer Driver

The Print quality setting is high.

Solutions

Set the **Print Quality** setting to **Fast** in the printer driver.

LCD Screen Gets Dark

The printer is in sleep mode.

Solutions

Press any button on the control panel to return the LCD screen to its former state.

Operation Sounds Are Loud

Quiet Mode is disabled on the printer.

Solutions

If operations sounds are too loud, enable **Quiet Mode**. Enabling this feature may reduce printing speed.

Control panel

Select  **OFF** on the home screen, and then enable **Quiet Mode**.

Windows

Enable **Quiet Mode** on the printer driver's **Main** tab.

Mac OS

Select **System Preferences** from the Apple menu > **Printers & Scanners** (or **Print & Scan, Print & Fax**), and then select the printer. Click **Options & Supplies** > **Options** (or **Driver**). Enable the **Quiet Mode** setting.

The Date and Time Are Incorrect

■ Error occurred in power supply.

Solutions

After a power failure caused by a lightning strike or if the power is left off for a long time, the clock may show the wrong time. Set the date and the time correctly in **Settings** > **General Settings** > **Basic Settings** > **Date/Time Settings** on the control panel.

The Root Certificate Needs to be Updated

■ The root certificate has expired.

Solutions

Run Web Config, select **Network Security** tab > **Root Certificate Update**, and then update the root certificate.

➔ [“Application for Configuring Printer Operations \(Web Config\)” on page 182](#)

Cannot Perform Manual 2-sided Printing (Windows)

■ EPSON Status Monitor 3 is disabled.

Solutions

On the printer driver's **Maintenance** tab, click **Extended Settings**, and then select **Enable EPSON Status Monitor 3**.

However, manual 2-sided printing may not be available when the printer is accessed over a network or is used as a shared printer.

The Print Settings Menu is Not Displayed (Mac OS)

■ The Epson Printer Driver has Not been Installed Correctly.

Solutions

If the **Print Settings** menu is not displayed on macOS Catalina (10.15) or later, macOS High Sierra (10.13), macOS Sierra (10.12), OS X El Capitan (10.11), OS X Yosemite (10.10), OS X Mavericks (10.9), the Epson printer driver has not been installed correctly. Enable it from the following menu.

Select **System Preferences** from the Apple menu > **Printers & Scanners** (or **Print & Scan, Print & Fax**), remove the printer, and then add the printer again.

macOS Mojave (10.14) cannot access **Print Settings** in applications made by Apple such as TextEdit.

Forgot Your Password

■ You need help from service personnel.

Solutions

If you forget the administrator's password, contact Epson support.

Cannot Solve Problem

If you cannot solve the problem after trying all of the solutions, contact Epson support.

If you cannot solve printing problems, see the following related information.

Related Information

➔ [“Cannot Solve Printing Problems” on page 170](#)

Cannot Solve Printing Problems

Try the following solutions in order starting at the top until you solve the problem.

- Make sure you match the paper type loaded in the printer and the paper type set on the printer to the paper type settings in the printer driver.
[“Paper Size and Type Settings” on page 75](#)
- Use a higher quality setting on the control panel or the printer driver.
- Reinstall the ink supply units already installed in the printer.
Reinstalling the ink supply units may clear clogging in the print head nozzles and allow the ink to flow smoothly.
However, because ink is consumed when the ink supply unit is reinstalled, a message asking you to replace the ink supply unit may be displayed depending on the amount of ink remaining.
- Use the **Print Quality Adjustment** feature.
[“Adjusting the Print Quality” on page 123](#)
- Check that you are using genuine Epson ink supply units.
Try to use genuine Epson ink supply units. The use of non-genuine ink supply units may cause print quality to decline.
- Check if the translucent film is smeared.
If there are smears on the translucent film, carefully wipe off the smear.
[“Cleaning the Translucent Film” on page 126](#)
- Make sure that there are no paper fragments left inside the printer.
- Check the paper.
Check if the paper is curled or loaded with the printable side facing up.
[“Paper Handling Precautions” on page 75](#)
[“Available Paper and Capacities” on page 173](#)
[“Unavailable Paper Types” on page 176](#)

If you cannot solve the problem by checking the solutions above, you may need to request repairs. Contact Epson support.

Related Information

- ➔ [“Before Contacting Epson” on page 276](#)
- ➔ [“Contacting Epson Support” on page 276](#)

Product Information

Paper Information.	173
Consumable Products Information.	176
Information on Optional Items.	178
Software Information.	178
Settings Menu List.	184
Product Specifications.	198
Font Specifications.	207
Regulatory Information.	213

Paper Information

Available Paper and Capacities

Genuine Epson Paper

Epson recommends using genuine Epson paper to ensure high-quality printouts.

Note:

- Genuine Epson paper is not available when printing with the Epson universal printer driver.*
- The availability of paper varies by location. For the latest information on paper available in your area, contact Epson support.*
- See the following for information on available paper types for 2-sided printing.*
[“Paper for 2-Sided Printing” on page 175](#)
- When printing on genuine Epson paper at a user defined size, only **Standard** or **Normal** print quality settings are available. Although some printer drivers allow you to select a better print quality, the printouts are printed using **Standard** or **Normal**.*

Paper suitable for printing documents

Media Name	Size	Loading Capacity (Sheets)		
		Paper Cassette 1	Paper Cassette 2 to 4	Paper Tray
Epson Business Paper	A4	Up to the line indicated by the  symbol on the edge guide.		80
Epson Bright White Ink Jet Paper	A4	200	400	50

Paper suitable for printing documents and photos

Media Name	Size	Loading Capacity (Sheets)		
		Paper Cassette 1	Paper Cassette 2 to 4	Paper Tray
Epson Photo Quality Ink Jet Paper	A4	80	80	70
Epson Matte Paper-Heavyweight	A4, 20x25 cm (8x10 in.)	50	50	20
Epson Double-Sided Matte Paper	A4	50	50	20

Commercially Available Paper

Note:

- ❑ Half Letter, SP1 (210×270 mm), SP2 (210×149 mm), SP3 (100×170 mm), SP4 (130×182 mm), SP5 (192×132 mm), 16K (195×270 mm), and Indian-Legal sizes are not available when printing with the PostScript printer driver.
- ❑ See the following for information on available paper types for 2-sided printing.
[“Paper for 2-Sided Printing” on page 175](#)

Plain papers

Plain paper includes copy paper, preprinted paper (paper on which various forms are pre-printed such as slips or securities), letterhead, color paper, and recycled paper.

Size	Loading Capacity (Sheets)		
	Paper Cassette 1	Paper Cassette 2 to 4	Paper Tray
A4, A5, A6, B5, B6, Executive, Half Letter, 16K (195×270 mm), Indian-Legal, Letter, 8.5×13 in., Legal, SP1 (210 x 270 mm), SP2 (210×149 mm), SP3 (100×170mm), SP4 (130×182 mm)	Up to the line indicated by the ▼ symbol on the edge guide.		80
SP5 (192×132 mm)	Up to the line indicated by the ▼ symbol on the edge guide.	-	80
User Defined(mm) 85 to 215.9×125 to 355.6	Up to the line indicated by the ▼ symbol on the edge guide.	-	-
User Defined(mm) 100 to 215.9×148 to 355.6	-	Up to the line indicated by the ▼ symbol on the edge guide.	-
User Defined(mm) 64 to 215.9×125 to 6000	-	-	80

Thick paper (91 to 160 g/m²)

Size	Loading Capacity (Sheets)		
	Paper Cassette 1	Paper Cassette 2 to 4	Paper Tray
A4, A5, A6, B5, B6, Executive, Half Letter, 16K (195×270 mm), Indian-Legal, Letter, 8.5×13 in., Legal, SP1 (210 x 270 mm), SP2 (210×149 mm), SP3 (100×170mm), SP4 (130×182 mm)	90	250	30
SP5 (192×132 mm)	90	-	30
User Defined(mm) 85 to 215.9×125 to 355.6	90	-	-

Size	Loading Capacity (Sheets)		
	Paper Cassette 1	Paper Cassette 2 to 4	Paper Tray
User Defined(mm) 100 to 215.9×148 to 355.6	-	250	-
User Defined(mm) 64 to 215.9×125 to 6000	-	-	30

Thick paper (161 to 256 g/m²)

Size	Loading Capacity (Sheets)		
	Paper Cassette 1	Paper Cassette 2 to 4	Paper Tray
A4, A5, A6, B5, B6, Executive, Half Letter, 16K (195×270 mm), Indian-Legal, Letter, 8.5×13 in., Legal	-	-	30
User Defined(mm) 64 to 215.9×125 to 6000	-	-	30

Envelope

Media Name	Size	Loading Capacity (Envelopes)		
		Paper Cassette 1	Paper Cassette 2 to 4	Paper Tray
Envelope	Envelope #10, Envelope DL, Envelope C6	10	-	10
	Envelope C4	-	-	1

Paper for 2-Sided Printing

Genuine Epson Paper

- Epson Business Paper
- Epson Bright White Ink Jet Paper

Related Information

➔ [“Available Paper and Capacities” on page 173](#)

Commercially Available Paper

Only use the paper tray to print 2-sided print jobs manually.

- Plain paper, Copy paper, Preprinted paper, Letterhead, Color paper, Recycled paper^{*1}

- Thick paper (91 to 160 g/m²)*¹
- Thick paper (161 to 256 g/m²)*²

*1 A4, A5, B5, Executive, 16K, SP1, and user-defined size (148 to 215.9 x 210 to 297 mm) paper is supported for automatic 2-sided printing.

*2 Manual 2-sided printing only.

Related Information

➔ [“Available Paper and Capacities” on page 173](#)

Unavailable Paper Types

Do not use the following papers. Using these types of paper causes paper jams and smears on the printout.

- Papers that are wavy
- Papers that are torn or cut
- Papers that are folded
- Papers that are damp
- Papers that are too thick or too thin
- Papers that have stickers

Do not use the following envelopes. Using these types of envelope causes paper jams and smears on the printout.

- Envelopes that are curled or folded
- Envelopes with adhesive surfaces on the flaps or window envelopes
- Envelopes that are too thin
They may curl during printing.

Consumable Products Information

Ink Supply Unit Codes

Epson recommends the use of genuine Epson ink supply units. Epson cannot guarantee the quality or reliability of non-genuine ink. The use of non-genuine ink may cause damage that is not covered by Epson's warranties, and under certain circumstances, may cause erratic printer behavior. Information about non-genuine ink levels may not be displayed.

The following are the codes for genuine Epson ink supply units.

Note:

- Ink supply unit codes may vary by location. For the correct codes in your area, contact Epson support.
- Not all ink supply units are available in all regions.

For Europe

Size	Black
XL	T12F1
L	T12E1
S	T12D1

Visit the following website for information on Epson's ink supply unit yields.

<http://www.epson.eu/pageyield>

For Australia and New Zealand

Black
T12J1, T12H1

For Asia

Black
T11Y1, T11W1, T11V1

Maintenance Box Code

Epson recommends the use of a genuine Epson maintenance box.

Maintenance box code: C9382



Important:

Once a maintenance box has been installed in a printer it cannot be used with other printers.

Pickup Rollers Code

Epson recommends the use of genuine Epson pickup rollers.

The following are the codes.

For all countries except for India, Bangladesh, Bhutan, Maldives, Sri Lanka and Nepal

Paper cassette 1 (Paper Feed Roller for Cassette A): C12C938261

Paper cassette 2 to 4 (Paper Feed Roller for Cassette B): C12C938281

For India, Bangladesh, Bhutan, Maldives, Sri Lanka and Nepal

Paper cassette 1 (Paper Feed Roller for Cassette A): C12C938271

Paper cassette 2 to 4 (Paper Feed Roller for Cassette B): C12C938291

Information on Optional Items

Optional Paper Cassette Unit Code

The following is the code for the optional paper cassette unit.

For all countries except for India, Bangladesh, Bhutan, MaldivesSri Lanka and Nepal

Optional Single Cassette-P2 (C12C937901)

For India, Bangladesh, Bhutan, MaldivesSri Lanka and Nepal

Optional Single Cassette-P2 (C12C937911)

Software Information

This section introduces some of the applications available for your printer. For a list of supported software, see the following Epson website or launch Epson Software Updater for confirmation. You can download the latest applications.

<http://www.epson.com>

Related Information

➔ [“Application for Updating Software and Firmware \(Epson Software Updater\)” on page 183](#)

Application for Printing from a Computer (Windows Printer Driver)

The printer driver controls the printer according to the commands from an application. Making settings on the printer driver provides the best printing results. You can also check the status of the printer or keep it in top operating condition using the printer driver utility.

Note:

*You can change the language of the printer driver. Select the language you want to use from the **Language** setting on the **Maintenance** tab.*

Accessing the printer driver from applications

To make settings that apply only to the application you are using, access from that application.

Select **Print** or **Print Setup** from the **File** menu. Select your printer, and then click **Preferences** or **Properties**.

Note:

Operations differ depending on the application. See the application's help for details.

Accessing the printer driver from the control panel

To make settings that apply to all of the applications, access from the control panel.

❑ Windows 11

Click on the start button, and then select **All apps > Windows Tools > Control Panel > View devices and printers** in **Hardware and Sound**. Right-click on your printer, or press and hold it and then select **Printing preferences**.

❑ Windows 10/Windows Server 2022/Windows Server 2019/Windows Server 2016

Click on the start button, and then select **Windows System > Control Panel > View devices and printers** in **Hardware and Sound**. Right-click on your printer, or press and hold it and then select **Printing preferences**.

❑ Windows 8.1/Windows 8/Windows Server 2012 R2/Windows Server 2012

Select **Desktop > Settings > Control Panel > View devices and printers** in **Hardware and Sound**. Right-click on your printer, or press and hold it and then select **Printing preferences**.

❑ Windows 7/Windows Server 2008 R2

Click the start button, and select **Control Panel > View devices and printers** in **Hardware and Sound**. Right-click on your printer and select **Printing preferences**.

❑ Windows Vista/Windows Server 2008

Click the start button, and select **Control Panel > Printers** in **Hardware and Sound**. Right-click on your printer and select **Printing preferences**.

❑ Windows XP/Windows Server 2003 R2/Windows Server 2003

Click the start button, and select **Control Panel > Printers and Other Hardware > Printers and Faxes**. Right-click on your printer and select **Printing preferences**.

Accessing the printer driver from the printer icon on the task bar

The printer icon on the desktop task bar is a shortcut icon allowing you to quickly access the printer driver.

If you click the printer icon and select **Printer Settings**, you can access the same printer settings window as the one displayed from the control panel. If you double-click this icon, you can check the status of the printer.

Note:

*If the printer icon is not displayed on the task bar, access the printer driver window, click **Monitoring Preferences** on the **Maintenance** tab, and then select **Register the shortcut icon to the taskbar**.*

Starting the utility

Access the printer driver window. Click the **Maintenance** tab.

Related Information

➔ [“Menu Options for the Printer Driver” on page 82](#)

Application for Printing from a Computer (Mac OS Printer Driver)

The printer driver controls the printer according to the commands from an application. Making settings on the printer driver provides the best printing results. You can also check the status of the printer or keep it in top operating condition using the printer driver utility.

Accessing the printer driver from applications

Click **Page Setup** or **Print** on the **File** menu of your application. If necessary, click **Show Details** (or ▼) to expand the print window.

Note:

Depending on the application being used, **Page Setup** may not be displayed in the **File** menu, and the operations for displaying the print screen may differ. See the application's help for details.

Starting the utility

Select **System Preferences** from the Apple menu > **Printers & Scanners** (or **Print & Scan, Print & Fax**), and then select the printer. Click **Options & Supplies > Utility > Open Printer Utility**.

Related Information

➔ [“Menu Options for the Printer Driver” on page 108](#)

Guide to Mac OS Printer Driver

Epson Printer Utility

You can run a maintenance feature such as nozzle check and print head cleaning, and by starting **EPSON Status Monitor**, you can check printer status and error information.

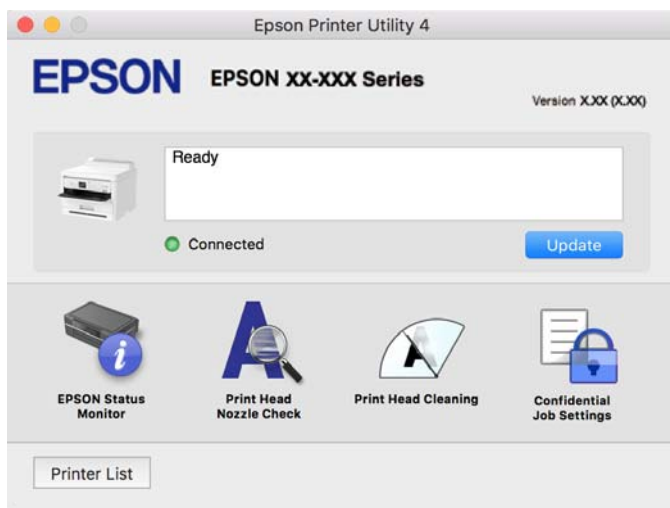

Application that can print PostScript Fonts (Windows PostScript Printer Driver)

The PostScript printer driver allows the printer to receive and interpret print instructions in the page description language sent from the computer and print properly. This is suitable for printing from PostScript compliant applications used for DTP.

Accessing the printer driver from applications

To make settings that apply only to the application you are using, access from that application.

Select **Print** or **Print Setup** from the **File** menu. Select your printer, and then click **Preferences** or **Properties**.

Note:

Operations differ depending on the application. See the application's help for details.

Accessing the printer driver from the control panel

To make settings that apply to all of the applications, access from the control panel.

Windows 11

Click on the start button, and then select **All apps > Windows Tools > Control Panel > View devices and printers in Hardware and Sound**. Right-click on your printer, or press and hold it and then select **Printing preferences**.

Windows 10/Windows Server 2022/Windows Server 2019/Windows Server 2016

Click on the start button, and then select **Windows System > Control Panel > View devices and printers in Hardware and Sound**. Right-click on your printer, or press and hold it and then select **Printing preferences**

Windows 8.1/Windows 8/Windows Server 2012 R2/Windows Server 2012

Select **Desktop > Settings > Control Panel > View devices and printers in Hardware and Sound**. Right-click on your printer, or press and hold it and then select **Printing preferences**

Windows 7/Windows Server 2008 R2

Click the start button, and select **Control Panel > View devices and printers in Hardware and Sound**. Right-click on your printer and select **Printing preferences**.

Windows Vista/Windows Server 2008

Click the start button, and select **Control Panel > Printers in Hardware and Sound**. Right-click on your printer and select **Printing preferences**.

Windows XP/Windows Server 2003 R2/Windows Server 2003

Click the start button, and select **Control Panel > Printers and Other Hardware > Printers and Faxes**. Right-click on your printer and select **Printing preferences**.

Accessing the printer driver from the printer icon on the task bar

The printer icon on the desktop task bar is a shortcut icon allowing you to quickly access the printer driver.

If you click the printer icon and select **Printer Settings**, you can access the same printer settings window as the one displayed from the control panel. If you double-click this icon, you can check the status of the printer.

Related Information

➔ [“Menu Options for the PostScript Printer Driver” on page 103](#)

Application that can print PostScript Fonts (Mac OS PostScript Printer Driver)

The PostScript printer driver allows the printer to receive and interpret print instructions in the page description language sent from the computer and print properly. This is suitable for printing from PostScript compliant applications used for DTP.

Accessing the printer driver from applications

Click **Page Setup** or **Print** on the **File** menu of your application. If necessary, click **Show Details** (or ▼) to expand the print window.

Note:

Depending on the application being used, **Page Setup** may not be displayed in the **File** menu, and the operations for displaying the print screen may differ. See the application's help for details.

Starting the utility

Select **System Preferences** from the Apple menu > **Printers & Scanners** (or **Print & Scan, Print & Fax**), and then select the printer. Click **Options & Supplies > Utility > Open Printer Utility**.

Related Information

➔ [“Menu Options for the PostScript Printer Driver” on page 114](#)

Application that can print PCL Language (PCL Printer Driver)

The PCL Printer Driver allows the printer to receive and interpret print instructions in the page description language sent from the computer and print properly. This is suitable for printing from general applications such as Microsoft Office.

Note:

Mac OS is not supported.

Connect the printer to the same network as the computer, and then follow the procedure below to install the printer driver.

1. Download the executable file of the driver from the Epson support website.

<http://www.epson.eu/Support> (Europe only)

<http://support.epson.net/>

2. Double-click the executable file.
3. Follow the on-screen instructions for the rest of the installation.

Note:

If your product comes with a software disc, you can also install using the disc. Access "Driver\PCL Universal".

Application for Configuring Printer Operations (Web Config)

Web Config is an application that runs in a web browser, such as Microsoft Edge and Safari, on a computer or smart device. You can confirm the printer status or change the network service and printer settings. To use the Web Config, connect the printer and the computer or device to the same network.

The following browsers are supported. Use the latest version.

Microsoft Edge, Internet Explorer, Firefox, Chrome, Safari

Note:

You may be asked to enter the administrator password while operating Web Config. See the related information below for more details.

Related Information

➔ [“Default Value of the Administrator Password” on page 16](#)

Running Web Config on a Web Browser

1. Check the printer's IP address.

Select the network icon on the printer's home screen, and then select the active connection method to confirm the printer's IP address.

To select an item, use the ▲ ▼ ◀▶ buttons, and then press the OK button.

Note:

You can also check the IP address by printing the network connection report.

2. Launch a Web browser from a computer or smart device, and then enter the printer's IP address.

Format:

IPv4: http://the printer's IP address/

IPv6: http://[the printer's IP address]/

Examples:

IPv4: http://192.168.100.201/

IPv6: http://[2001:db8::1000:1]/

Note:

Using the smart device, you can also run Web Config from the product information screen of the Epson Smart Panel.

Since the printer uses a self-signed certificate when accessing HTTPS, a warning is displayed on the browser when you start Web Config; this does not indicate a problem and can be safely ignored.

Related Information

- ➔ [“Printing a Network Connection Report” on page 48](#)
- ➔ [“Printing Using Epson Smart Panel” on page 117](#)

Application for Updating Software and Firmware (Epson Software Updater)

Epson Software Updater is an application that installs new software, and updates firmware over the Internet. If you want to check for update information regularly, you can set the interval for checking for updates in Epson Software Updater's Auto Update Settings.

Note:

Windows Server operating systems are not supported.

Starting on Windows

- Windows 11

Click the start button, and then select **All apps > EPSON Software > Epson Software Updater**.

- Windows 10

Click the start button, and then select **EPSON Software > Epson Software Updater**.

- Windows 8.1/Windows 8

Enter the application name in the search charm, and then select the displayed icon.

- Windows 7/Windows Vista/Windows XP

Click the start button, and then select **All Programs** (or **Programs**) > **EPSON Software** > **Epson Software Updater**.

Note:

You can also start Epson Software Updater by clicking the printer icon on the task bar on the desktop, and then selecting Software Update.

Starting on Mac OS

Select **Go** > **Applications** > **Epson Software** > **Epson Software Updater**.

Related Information

➔ [“Installing the Applications Separately” on page 131](#)

Software for Managing Devices on the Network (Epson Device Admin)

Epson Device Admin is a multifunctional application software that manages the device on the network.

The following functions are available.

- Monitor or manage up to 2,000 printers over the segment
- Make a detailed report, such as for the consumable or product status
- Update the firmware of the product
- Introduce the device to the network
- Apply the unified settings to multiple devices.

You can download Epson Device Admin from Epson support website. For more information, see the documentation or help of Epson Device Admin.

Epson Authentication System (Epson Print Admin)

Epson Print Admin is an authentication system that allows you to manage Epson devices, as well as support cost reduction and operational efficiency thereby ensuring security. There are features listed below.

Contact your dealer for more information.

- Printing after authenticating the device.
- Limiting devices, functions, and time periods in which users can access the device.
- Storing records on all users and devices.
- Registering users by using the user information in Active Directory or LDAP server.

Settings Menu List

Select **Settings** on the home screen of the printer to make various settings.

General Settings

Select the menus on the control panel as described below.

Settings > General Settings

Basic Settings

Select the menus on the control panel as described below.

Settings > General Settings > Basic Settings

LCD Brightness:

Adjust the brightness of the LCD screen.

Sleep Timer:

Adjust the time period to enter a sleep mode (energy saving mode) when the printer has not performed any operations. The LCD screen turns black when the setting time passes.

Power Off Timer:

Your product may have this feature or the **Power Off Settings** feature depending on the location of purchase.

Select this setting to turn the printer off automatically when it is not used for a specified period of time. You can adjust the time before power management is applied. Any increase will affect the product's energy efficiency. Please consider the environment before making any change.

Power Off Settings:

Your product may have this feature or the **Power Off Timer** feature depending on the location of purchase.

Power Off If Inactive:

Select this setting to turn the printer off automatically if it is not used for a specified period of time. You can adjust the time before power management is applied. Any increase will affect the product's energy efficiency. Please consider the environment before making any change.

Power Off If Disconnected:

Select this setting to turn the printer off after a specified period of time when all ports including the USB port are disconnected. This feature may not be available depending on your region.

See the following website for the specified period of time.

<https://www.epson.eu/energy-consumption>

Date/Time Settings:

Date/Time:

Enter the current date and time.

Daylight Saving Time:

Select the summer time setting that applies to your area.

Time Difference:

Enter the time difference between your local time and UTC (Coordinated Universal Time).

Language: 

Select the language used on the LCD screen.

Operation Time Out: 

Select **On** to return to the initial screen when no operations have been performed for the specified time.

Keyboard:

Change the layout of the keyboard on the LCD screen.

Related Information

➔ [“Entering Characters” on page 28](#)

Printer Settings

Select the menus on the control panel as described below.

Settings > General Settings > Printer Settings

Paper Source Settings:

Paper Setting:

Select the paper size and paper type you loaded in the paper source.

Paper Tray Priority:

Select **On** to give printing priority to paper loaded in the paper tray.

A4/Letter Auto Switching:

Select **On** to feed paper from the paper source set as A4 size when there is no paper source set as Letter, or feed from the paper source set as Letter size when there is no paper source set as A4.

Auto Select Settings:

If you enable **Paper Setting > Auto**, paper is automatically fed from a paper source that has the same settings as the paper settings for the current print job when paper runs out. In this menu, you can set automatic selection for each paper source. You cannot set everything to off.

This setting is disabled when you select a specific paper source in the paper settings for the print jobs. Depending on the paper type setting on the **Main** tab of the printer driver, paper may not be fed automatically.

Error Notice:

Paper Size Notice:

Select **On** to display an error message when the selected paper size does not match the loaded paper.

Paper Type Notice:

Select **On** to display an error message when the selected paper type does not match the loaded paper.

Paper Setup Auto Display:

Select **On** to display the **Paper Setting** screen when loading paper in the paper source. If you disable this feature, you cannot print from an iPhone, iPad, or iPod touch using AirPrint.

Printing Language: 

USB:

Select the printing language for the USB interface.

Network:

Select the printing language for the network interface.

Universal Print Settings: 

These print settings are applied when you print by an external device without using the printer driver. The offset settings are applied when you print using the printer driver.

Top Offset:

Adjust the top margin of the paper.

Left Offset:

Adjust the left margin of the paper.

Top Offset in Back:

Adjust the top margin for the back of the page when performing 2-sided printing.

Left Offset in Back:

Adjust the left margin for the back of the page when performing 2-sided printing.

Check Paper Width:

Select **On** to check the paper width before printing. This prevents printing beyond the edges of the paper when the paper size setting is incorrect, but this may lower the print speed.

Skip Blank Page:

Skips blank pages in the print data automatically to save paper.

PDL Print Configuration: 

Select the PDL Print Configuration options you want to use for PCL or PostScript printing.

Common Settings:

Select the common settings for PCL or PostScript printing.

Paper Size:

Select the default paper size for printing.

Paper Type:

Select the default paper type for printing.

Orientation:

Select the default orientation for printing.

Quality:

Select the print quality.

Ink Save Mode:

Select **On** to save ink by reducing the print density.

Print Order:

Select the print order, from the first page or the last page.

Last Page on Top:

Starts printing from the first page of a file.

First Page on Top:

Starts printing from the last page of a file.

Number of Copies:

Set the number of copies to print.

Binding Margin:

Select the binding position.

Auto Paper Ejection:

Select **On** to eject paper automatically when printing is stopped during a print job.

2-Sided Printing:

Select **On** to perform 2-sided printing.

PCL Menu:

Make settings for PCL printing.

Font Source:

Resident:

Select to use a font preinstalled on the printer.

Download:

Select to use a font you have downloaded.

Font Number:

Select the default font number for the default Font Source. The available number varies depending on the settings you made.

Pitch:

Set the default font pitch if the font is scalable and of fixed-pitch. You can select from 0.44 to 99.99 cpi (characters per inch), in 0.01 increments.

This item may not appear depending on the Font Source or Font Number settings.

Height:

Set the default font height if the font is scalable and proportional. You can select from 4.00 to 999.75 points, in 0.25 increments.

This item may not appear depending on the Font Source or Font Number settings.

Symbol Set:

Select the default symbol set. If the font that you selected in the Font Source and the Font Source setting is not available in the new symbol set setting, the Font Source and the Font Number settings are automatically replaced with the default value, IBM-US.

Form:

Set the number of lines for the selected paper size and orientation. This also causes a line spacing (VMI) change, and the new VMI value is stored in the printer. This means that later changes in the page size or orientation settings cause changes in the Form value based on the stored VMI.

CR Function:

Select the line feed command when printing with a driver from a specific operating system.

LF Function:

Select the line feed command when printing with a driver from a specific operating system.

Paper Source Assign:

Set the assignment for the paper source select command. When **4** is selected, the commands are set as compatible with the HP LaserJet 4. When **4K** is selected, the commands are set as compatible with the HP LaserJet 4000, 5000, and 8000. When **5S** is selected, the commands are set as compatible with the HP LaserJet 5S.

PS Menu:

Make settings for PS printing.

Error Sheet:

Select **On** to print a sheet showing the status when an error occurs during PostScript or PDF printing.

Binary:

Select **On** when printing data that contains binary images. The application may send the binary data even if the printer driver setting is set to ASCII, but you can print the data when this feature is enabled.

PDF Page Size:

Select the paper size when printing a PDF file.

Auto Error Solver: 

Select an action to perform when a 2-sided printing error or a memory full error occurs.

On

Displays a warning and prints in single-sided mode when a 2-sided printing error occurs, or prints only what the printer could process when a memory full error occurs.

Off

Displays an error message and cancels printing.

Thick Paper: 

Select **On** to prevent ink from smearing on your printouts, however, this may lower the print speed.

Quiet Mode: 

Select **On** to reduce noise during printing, however, this may lower the print speed. Depending on the paper type and print quality settings you selected, there may be no difference in the printer's noise level. Select **On** to prioritize reducing operation noise. To prioritize printing speed, select **On (Low Level)**.

Ink Drying Time:

Select the ink drying time you want to use when performing 2-sided printing. The printer prints the other side after printing one side. If your printout is smeared, increase the time setting.

PC Connection via USB: 

Select **Enable** to allow a computer to access the printer when connected by USB. When **Disable** is selected, printing that is not sent over a network connection is restricted.

USB I/F Timeout Setting: 

Specify the length of time in seconds that must elapse before ending USB communication with a computer after the printer receives a print job from a PostScript printer driver or PCL printer driver. If the job ending is not clearly defined from a PostScript printer driver or PCL printer driver, it can cause endless USB communication. When this occurs, the printer ends communication after the specified time has elapsed. Enter 0 (zero) if you do not want to end communication.

Related Information

- ➔ [“Loading Paper” on page 77](#)
- ➔ [“Printing Using Easy Settings” on page 80](#)

Network Settings

Select the menus on the control panel as described below.

Settings > General Settings > Network Settings

Wi-Fi Setup:

Set up or change wireless network settings. Choose the connection method from following and then follow the instructions on the control panel.

Router:

Wi-Fi Setup Wizard:

Makes Wi-Fi settings by entering the SSID and password.

Push Button Setup (WPS):

Makes Wi-Fi settings by Push Button Setup (WPS).

Others:

PIN Code Setup (WPS)

Makes Wi-Fi settings by PIN Code Setup (WPS).

Wi-Fi Auto Connect

Makes Wi-Fi settings by using the Wi-Fi information on the computer or smart device.

Disable Wi-Fi

Disables Wi-Fi. Infrastructure connections will be disconnected.

Wi-Fi Direct:

(Menu) :

Change Network Name

Changes the Wi-Fi Direct SSID (network name).

Change Password

Changes the password for the Wi-Fi Direct connection.

Change Frequency Range

Select the frequency band for Wi-Fi Direct connection. Changing the frequency disconnects the connected device.

The availability of these channels and use of the product outdoors over these channels varies by location.

<http://support.epson.net/wifi5ghz/>

Disable Wi-Fi Direct

Disables the Wi-Fi Direct function.

Restore Default Settings

Restores the Wi-Fi Direct settings.

Other Methods:

iOS

Reads the QR code from your iPhone, iPad, or iPod touch to connect using Wi-Fi Direct.

Other OS Devices

Makes Wi-Fi Direct settings by entering the SSID and password.

Wired LAN Setup:

Set up or change a network connection that uses a LAN cable and router. When this is being used, Wi-Fi connections are disabled.

Network Status:

Wired LAN/Wi-Fi Status:

Displays the printer's network information.

Wi-Fi Direct Status:

Displays the Wi-Fi Direct setting information.

Print Status Sheet:

Prints a network status sheet.

The information for Ethernet, Wi-Fi, Wi-Fi Direct, and so on is printed on two or more pages.

Connection Check:

Checks the current network connection and prints a report. If there are any problems with the connection, see the report to solve the problem.

Advanced:

Device Name:

Changes the device name to any name within 2 to 53 characters.

TCP/IP:

Configures the IP settings, if the IP address is static.

For automatic configuration, use the IP address assigned by DHCP.

To set manually, switch to "Manual" and then enter the IP address you want to assign.

Proxy Server:

Set this if you are using a proxy server in your network environment and want to set it for the printer as well.

IPv6 Address:

Sets whether or not to enable IPv6 addressing.

Link Speed & Duplex:

Select an appropriate Ethernet speed and duplex setting. If you select a setting other than Auto, make sure the setting corresponds to the settings on the hub you are using.

Redirect HTTP to HTTPS:

Enables or disables redirecting from HTTP to HTTPS.

Disable IPsec/IP Filtering:

Disables the IPsec/IP filtering setting.

Disable IEEE802.1X:

Disables the IEEE802.1X setting.

iBeacon Transmission:

Select whether to enable or disable the iBeacon transmission function. When enabled, you can search for the printer from iBeacon-enabled devices.

Related Information

- ➔ “Making Wi-Fi Settings by Entering the SSID and Password” on page 46
- ➔ “Making Wi-Fi Settings by Push Button Setup (WPS)” on page 47
- ➔ “Making Wi-Fi Settings by PIN Code Setup (WPS)” on page 48
- ➔ “Checking the Printer's Network Connection Status (Network Connection Report)” on page 137

Web Service Settings 

Select the menus on the control panel as described below.

Settings > General Settings > Web Service Settings

Epson Connect Services:

Displays whether the printer is registered and connected to Epson Connect.

You can register to the service by selecting **Register** and follow the instructions.

For usage guides, see the following portal website.

<https://www.epsonconnect.com/>

<http://www.epsonconnect.eu> (Europe only)

When you have registered, you can change the following settings.

Suspend/Resume:

Select whether to suspend or resume Epson Connect services.

Unregister:

Unregisters the printer from Epson Connect services.

System Administration

By using this menu, you can maintain the product as a system administrator. It also allows you to restrict product features for individual users to suite your work or office style.

Select the menus on the control panel as described below.

Settings > General Settings > System Administration

Periodic Cleaning:

Enable this setting to perform periodic head cleaning when a certain number of pages have been printed or the printer detects that head cleaning is necessary. Select anything other than **Off** to maintain premium print quality. Under the following conditions, perform **Print Head Nozzle Check** and **Print Head Cleaning** yourself.

- Printout problems
- When **Off** is selected for **Periodic Cleaning**
- When printing at high quality, such as photos

Off:

Disables periodic head cleaning.

After Printing:

Performs periodic head cleaning when printing is complete.

Schedule:

Performs periodic head cleaning at the time you specified.

If the printer is turned off at the specified time, periodic head cleaning is performed when the printer is turned on.

Clear Internal Memory Data:

This item is displayed on PCL or PostScript compatible printer.

Delete the printer's internal memory data, such as a downloaded font and macro for PCL printing.

PDL Font, Macro, and Working Area:

This item is displayed on PCL or PostScript compatible printer.

Delete the printer's internal memory data, such as a downloaded font and macro for PCL printing.

Delete All Internal Memory Jobs:

Delete the printer's internal memory data, such as jobs with passwords.

Security Settings:

Admin Settings:

Admin Password:

Set, change, and clear an administrator password.

Lock Setting:

Select whether or not to lock the control panel using the password registered in **Admin Password**.

Password Encryption:

Select **On** to encrypt your password. If you turn off the power while the restart is in progress, data may be corrupted and the printer settings will be restored to their defaults. If this occurs, set the password information again.

Audit Log:

Select **On** to record an audit log.

Program Verification on Start Up:

Select **On** to verify the printer's program when starting up.

Customer Research:

If you agree to provide customer usage information, product usage information such as the number of prints will be provided to Seiko Epson Corporation.

The information collected is used to improve our products and services.

Provide usage data:

Displays whether or not you have agreed to provide your customer usage information.

Country/Region:

Displays the country or region where you are using the product if you have agreed to provide your customer usage information.

Restore Default Settings:

Network Settings:

Resets the network setting to the default.

All Except Network Settings:

Resets all settings except for network settings to their defaults.

All Settings:

Clears all the personal information stored in the printer's memory and resets all settings to their defaults.

Firmware Update:

You can get firmware information such as your current version and information on available updates.

Update:

Updates the firmware manually.

Automatic Firmware Update:

Automatic Firmware Update:

Select **On** to update firmware automatically and set the day of the week/start time to update.

Day:

Select the day of the week when you want to update the firmware.

Time:

Set the time when you want to start to update the firmware.

Notification:

Select **On** to display the firmware update icon on the home screen.

Firmware Version:

Displays the firmware version.

Print Counter

Select the menus on the control panel as described below.

Settings > Print Counter

Displays the total number of prints including items such as the status sheet from the time you purchased the printer. If you select **Print Sheet**, the Usage History Sheet is printed.



You can also check the number of pages printed from other functions on the Usage History Sheet.

Supply Status

Select the menu on the control panel as described below.

Settings > Supply Status

Displays the approximate level of the ink and service life of the maintenance box.

When  is displayed, the ink is running low or the maintenance box is nearly full. When  is displayed, you need to replace the item as ink is expended or the maintenance box is full.

Related Information

➔ [“It is Time to Replace Ink Supply Units” on page 163](#)

Maintenance

Select the menus on the control panel as described below.

Settings > Maintenance

Print Quality Adjustment:

Select this feature if there are any problems with your print outs. You can check for clogged nozzles and clean the print head if necessary, and then adjust some parameters to improve print quality.

Print Head Nozzle Check:

Select this feature to check if the print head nozzles are clogged. The printer prints a nozzle check pattern.

Print Head Cleaning:

Select this feature to clean clogged nozzles in the print head.

Print Head Alignment:

Ruled Line Alignment:

Select this feature to align vertical lines.

Horizontal Alignment:

Select this feature if horizontal banding appears at regular intervals in your printouts.

Paper Guide Cleaning:

Select this feature if there are ink stains on the internal rollers. The printer feeds paper to clean the internal rollers.

Pickup roller information:

Select this feature to check the pickup roller service life of the paper cassette. You can also reset the pickup roller counter.

Related Information

➔ [“Checking and Cleaning the Print Head” on page 124](#)

Language

Select the menus on the control panel as described below.

Settings > Language

Select the language used on the LCD screen.

Printer Status/Print

Select the menus on the control panel as described below.

Settings > Printer Status/Print

Print Status Sheet:

Configuration Status Sheet:

Print information sheets showing the current printer status and settings.

Supply Status Sheet:

Print information sheets showing the status of consumables.

Usage History Sheet:

Print information sheets showing the usage history of the printer.

PS Font List:

Print a list of fonts that are available for a PostScript printer.

PCL Font List:

Print a list of fonts that are available for a PCL print.

Network:

Displays the current network settings. You can also print the status sheet.

Authentication Device Status

Select the menus on the control panel as described below.

Settings > Authentication Device Status

Displays the status of the authentication device.

Epson Open Platform Information

Select the menus on the control panel as described below.

Settings > Epson Open Platform Information

Displays the status of the Epson Open Platform.

Product Specifications

Printer Specifications

Print Head Nozzle Placement	Black ink nozzles: 1600	
Weight of Paper*	Plain Paper	64 to 90 g/m ²
	Thick Paper	91 to 256 g/m ²
	Envelopes	75 to 100 g/m ²

* Even when the paper thickness is within this range, the paper may not feed in the printer or the print quality may decline depending on the paper properties or quality.

Printable Area

Printable Area for Single Sheets

Print quality may decline in the shaded areas due to the printer's mechanism.

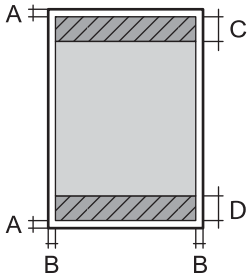
	A	3.0 mm (0.12 in.)
	B	3.0 mm (0.12 in.)
	C	47.0 mm (1.85 in.)
	D	45.0 mm (1.77 in.)

Printable Area for Envelopes

Print quality may decline in the shaded areas due to the printer's mechanism.

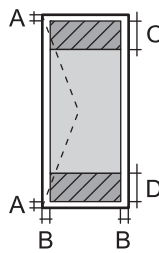
	A	3.0 mm (0.12 in.)
	B	3.0 mm (0.12 in.)
	C	18.0 mm (0.71 in.)
	D	47.0 mm (1.85 in.)

Using Port for the Printer

The printer uses the following port. These ports should be allowed to become available by the network administrator as necessary.

When the Sender (Client) is the Printer

Use	Destination (Server)	Protocol	Port Number
Email sending (When email notification is used from the printer)	SMTP server	SMTP (TCP)	25
		SMTP SSL/TLS (TCP)	465
		SMTP STARTTLS (TCP)	587
POP before SMTP connection (When email notification is used from the printer)	POP server	POP3 (TCP)	110
When Epson Connect is used	Epson Connect Server	HTTPS	443
		XMPP	5222
Control WSD	Client computer	WSD (TCP)	5357

When the Sender (Client) is the Client Computer

Use	Destination (Server)	Protocol	Port Number
File Sending (When FTP printing is used from the printer)	Printer	FTP (TCP)	20
			21
Discover the printer from an application such as EpsonNet Config, printer driver.	Printer	ENPC (UDP)	3289
Collect and set up the MIB information from an application such as EpsonNet Config, printer driver.	Printer	SNMP (UDP)	161
Forwarding LPR data	Printer	LPR (TCP)	515
Forwarding RAW data	Printer	RAW (Port9100) (TCP)	9100
Forwarding AirPrint (IPP/IPPS printing) data	Printer	IPP/IPPS (TCP)	631
Searching WSD printer	Printer	WS-Discovery (UDP)	3702
Web Config	Printer	HTTP(TCP)	80
		HTTPS(TCP)	443

Interface Specifications

For Computer	Hi-Speed USB*
--------------	---------------

* USB 3.0 cables are not supported.

Network Specifications

Wi-Fi Specifications

See the following table for Wi-Fi specifications.

Countries or regions except for those listed below	"Table A" on page 201
Ireland, United Kingdom, Austria, Germany, Liechtenstein, Switzerland, France, Belgium, Luxemburg, Netherlands, Italy, Portugal, Spain, Denmark, Finland, Norway, Sweden, Iceland, Croatia, Cyprus, Greece, North Macedonia, Serbia, Slovenia, Malta, Bosnia and Herzegovina, Kosovo, Montenegro, Albania, Bulgaria, Czech Republic, Estonia, Hungary, Latvia, Lithuania, Poland, Romania, Slovakia, Israel, Australia, New Zealand, China, Taiwan	"Table B" on page 201
Turkey	Serial numbers starting with XC7J: "Table A" on page 201 Serial numbers starting with XC7H: "Table B" on page 201

Table A

Standards	IEEE802.11b/g/n*1
Frequency Range	2.4 GHz
Channels	1/2/3/4/5/6/7/8/9/10/11/12/13
Coordination Modes	Infrastructure, Wi-Fi Direct (Simple AP)*2*3
Security Protocols*4	WEP (64/128bit), WPA2-PSK (AES)*5, WPA3-SAE (AES), WPA2/WPA3-Enterprise

*1 Only available for the HT20

*2 Not supported for IEEE 802.11b

*3 Infrastructure and Wi-Fi Direct modes or an Ethernet connection can be used simultaneously.

*4 Wi-Fi Direct supports WPA2-PSK (AES) only.

*5 Complies with WPA2 standards with support for WPA/WPA2 Personal.

Table B

Standards	IEEE802.11a/b/g/n*1/ac		
Frequency Ranges	IEEE802.11b/g/n: 2.4 GHz, IEEE802.11a/n/ac: 5 GHz		
Channels	Wi-Fi	2.4 GHz	1/2/3/4/5/6/7/8/9/10/11/12*2/13*2
		5 GHz*3	W52 (36/40/44/48), W53 (52/56/60/64), W56 (100/104/108/112/116/120/124/128/132/136/140/144), W58 (149/153/157/161/165)
	Wi-Fi Direct	2.4 GHz	1/2/3/4/5/6/7/8/9/10/11/12*2/13*2
		5 GHz*3	W52 (36/40/44/48) W58 (149/153/157/161/165)
Connection Modes	Infrastructure, Wi-Fi Direct (Simple AP)*4*5		
Security Protocols*6	WEP (64/128bit), WPA2-PSK (AES)*7, WPA3-SAE (AES), WPA2/WPA3-Enterprise		

*1 Only available for the HT20

*2 Not available in Taiwan

*3 The availability of these channels and use of the product outdoors over these channels varies by location. For more information, see the following website.

<http://support.epson.net/wifi5ghz/>

*4 Not supported for IEEE 802.11b

*5 Infrastructure and Wi-Fi Direct modes or an Ethernet connection can be used simultaneously.

*6 Wi-Fi Direct only supports WPA2-PSK (AES) .

*7 Complies with WPA2 standards with support for WPA/WPA2 Personal.

Ethernet Specifications

Standards	IEEE802.3i (10BASE-T)* ¹ IEEE802.3u (100BASE-TX)* ¹ IEEE802.3ab (1000BASE-T)* ¹ IEEE802.3az (Energy Efficient Ethernet)* ²
Communication Mode	Auto, 10 Mbps Full duplex, 10 Mbps Half duplex, 100 Mbps Full duplex, 100 Mbps Half duplex
Connector	RJ-45

*1 Use a category 5e or higher STP (Shielded twisted pair) cable to prevent risk of radio interference.

*2 The connected device should comply with IEEE802.3az standards.

Network Functions and IPv4/IPv6

Functions		Supported	Remarks	
Network Printing	EpsonNet Print (Windows)	IPv4	✓	-
	Standard TCP/IP (Windows)	IPv4, IPv6	✓	-
	WSD Printing (Windows)	IPv4, IPv6	✓	Windows Vista or later
	Bonjour Printing (Mac OS)	IPv4, IPv6	✓	-
	IPP Printing (Windows, Mac OS)	IPv4, IPv6	✓	-
	FTP Printing	IPv4, IPv6	✓	-
	Epson Connect (Email Print, Remote Print)	IPv4	✓	-
	AirPrint (iOS, Mac OS)	IPv4, IPv6	✓	iOS 5 or later, OS X Mavericks (10.9.5) or later*
Network Scanning	Epson Scan 2	IPv4, IPv6	-	-
	Document Capture Pro (Windows)	IPv4	-	-
	Document Capture (Mac OS)			
	Document Capture Pro Server (Windows)	IPv4, IPv6	-	-
	Epson Connect (Scan to Cloud)	IPv4	-	-
	AirPrint (Scan)	IPv4, IPv6	-	-

Functions			Supported	Remarks
Fax	Send a fax	IPv4	-	-
	Receive a fax	IPv4	-	-
	AirPrint (Faxout)	IPv4, IPv6	-	-

* We recommend using the latest version of iOS or Mac OS.

Security Protocol

IEEE802.1X*	
IPsec/IP Filtering	
SSL/TLS	HTTPS Server/Client
	IPPS
SMTPS (STARTTLS, SSL/TLS)	
SNMPv3	

* You need to use a device for connection that complies with IEEE802.1X.

PostScript Level 3 Compatibility

The PostScript used on this printer is compatible with PostScript Level 3.

Supported Third Party Services

Services		Supported	Remarks
AirPrint	Print	✓	iOS 5 or later/OS X Mavericks (10.9.5) or later*
	Scan	-	-
	Fax	-	-
Universal Print (Microsoft)		✓	Windows 10 2004 (20H1) or later

* We recommend using the latest version of iOS or Mac OS.

Dimensions

Dimensions*1

Condition	Paper Cassette 1 Installed	Paper Cassette 1 and 2 Installed	Paper Cassette 1, 2, and 3 Installed	Paper Cassette 1, 2, 3 and 4 Installed
Storage	<ul style="list-style-type: none"> <input type="checkbox"/> Width: 425 mm (16.7 in.) <input type="checkbox"/> Depth: 535 mm (21.1 in.) <input type="checkbox"/> Height: 357 mm (14.1in.) 	<ul style="list-style-type: none"> <input type="checkbox"/> Width: 425 mm (16.7 in.) <input type="checkbox"/> Depth: 535 mm (21.1 in.) <input type="checkbox"/> Height: 457 mm (18.0in.) 	<ul style="list-style-type: none"> <input type="checkbox"/> Width: 425 mm (16.7 in.) <input type="checkbox"/> Depth: 535 mm (21.1 in.) <input type="checkbox"/> Height: 557 mm (21.9in.) 	<ul style="list-style-type: none"> <input type="checkbox"/> Width: 425 mm (16.7 in.) <input type="checkbox"/> Depth: 535 mm (21.1 in.) <input type="checkbox"/> Height: 657 mm (25.9in.)
Printing	<ul style="list-style-type: none"> <input type="checkbox"/> Width: 425 mm (16.7 in.) <input type="checkbox"/> Depth: 578 mm (22.8 in.) <input type="checkbox"/> Height: 449 mm (17.7in.) 	<ul style="list-style-type: none"> <input type="checkbox"/> Width: 425 mm (16.7 in.) <input type="checkbox"/> Depth: 578 mm (22.8 in.) <input type="checkbox"/> Height: 549 mm (21.6in.) 	<ul style="list-style-type: none"> <input type="checkbox"/> Width: 425 mm (16.7 in.) <input type="checkbox"/> Depth: 578 mm (22.8 in.) <input type="checkbox"/> Height: 649 mm (25.6in.) 	<ul style="list-style-type: none"> <input type="checkbox"/> Width: 425 mm (16.7 in.) <input type="checkbox"/> Depth: 578 mm (22.8 in.) <input type="checkbox"/> Height: 749 mm (29.5in.)

Weight*1*2

Condition	Paper Cassette 1 Installed	Paper Cassette 1 and 2 Installed	Paper Cassette 1, 2, and 3 Installed	Paper Cassette 1, 2, 3 and 4 Installed
Weight	Approx. 15.0 kg (33.1 lb)	Approx. 19.5 kg (43.0 lb)	Approx. 24.0 kg (52.9 lb)	Approx. 28.5 kg (62.8 lb)

*1 With the output tray.

*2 Without the ink supply units and the power cord.

Electrical Specifications

Power Supply Rating	AC 100-240 V	AC 220-240 V
Rated Frequency Range	50-60 Hz	50-60 Hz
Rated Current	0.7-0.4 A	0.4 A
Power Consumption (with USB Connection)	Printing: Approx. 25.0 W (ISO/IEC24712) Ready mode: Approx. 9.8 W Sleep mode: Approx. 1.1 W Power off: Approx. 0.2 W	Printing: Approx. 25.0 W (ISO/IEC24712) Ready mode: Approx. 9.8 W Sleep mode: Approx. 1.1 W Power off: Approx. 0.2 W

Note:

Check the label on the printer for its voltage.

For European users, see the following Website for details on power consumption.

<http://www.epson.eu/energy-consumption>

Environmental Specifications

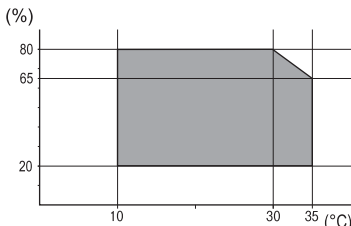
Operation	<p>Use the printer within the temperature (°C) and humidity (%) ranges shown in the graph, and in an environment without condensation.</p> 
Storage	<p>Temperature after initial ink charging: -15 to 40°C (5 to 104°F)*</p> <p>Temperature before initial ink charging: -20 to 40°C (-4 to 104°F)*</p> <p>Humidity: 5 to 85% RH (without condensation)</p>

* You can store for one month at 40°C (104°F).

Environmental Specifications for Ink Supply Units

Storage Temperature	-30 to 40 °C (-22 to 104 °F)*
Freezing Temperature	<p>Ink may freeze if it is stored below 0 °C (32 °F).</p> <p>Ink thaws and is usable after approximately 5 hours at 25 °C (77 °F).</p>

* You can store for one month at 40 °C (104 °F).

Installation Location and Space

To ensure safe use, place the printer in a location that meets the following conditions.

- A flat, stable surface that can support the weight of the printer
- Locations that do not block or cover the vents and openings in the printer
- Locations where you can load paper and remove paper easily
- Locations that meet the conditions in the "Environmental Specifications" in this manual

! *Important:*

Do not place the printer in the following locations; otherwise a malfunction may occur.

- Subject to direct sunlight*
- Subject to rapid changes in temperature and humidity*
- Subject to fire*
- Subject to volatile substances*
- Subject to shocks or vibrations*
- Near a television or a radio*
- Near excessive dirt or dust*
- Near water*
- Near air-conditioning or heating equipment*
- Near a humidifier*

Use a commercially available anti-static mat to prevent static generation in locations prone to generating static electricity.

Secure enough place to install and operate the printer correctly.

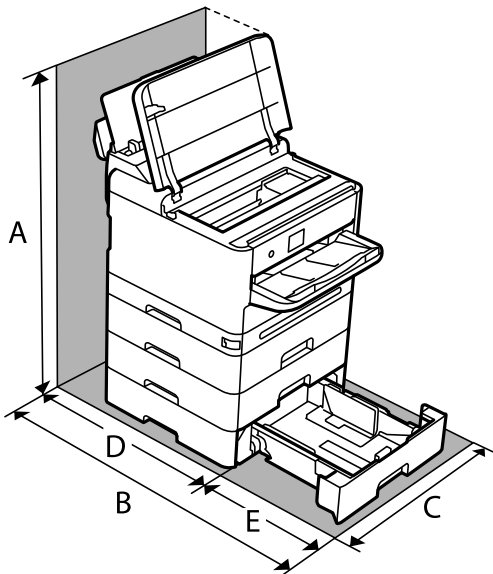

A	843.9mm
B	907.0mm
C	425.0mm
D	475.5mm
E	431.5mm

System Requirements

Windows

Windows Vista, Windows 7, Windows 8/8.1, Windows 10, Windows 11 or later

Windows XP SP3 (32-bit)

Windows XP Professional x64 Edition SP2

Windows Server 2003 (SP2) or later

Mac OS

Mac OS X 10.9.5 or later, macOS 11 or later

Note:

Mac OS may not support some applications and features.

The UNIX File System (UFS) for Mac OS is not supported.

Chrome OS

Chrome OS 89 or later

Note:

Only supports the standard OS features.

Font Specifications

Available Fonts for PostScript

Font Name	Family	HP Equivalent
Nimbus Mono	Medium, Bold, Italic, Bold Italic	Courier
Letter Gothic	Medium, Bold, Italic	Letter Gothic
Nimbus Mono PS	Regular, Bold, Oblique, Bold Oblique	CourierPS
Nimbus Roman No4	Medium, Bold, Italic, Bold Italic	CG Times
URW Classico	Medium, Bold, Italic, Bold Italic	CG Omega
URW Coronet	-	Coronet
URW Clarendon Condensed	-	Clarendon Condensed
URW Classic Sans	Medium, Bold, Italic, Bold Italic	Univers
URW Classic Sans Condensed	Medium, Bold, Italic, Bold Italic	Univers Condensed
Antique Olive	Medium, Bold, Italic	Antique Olive
Garamond	Antiqua, Halbfett, Kursiv, Kursiv Halbfett	Garamond
Mauritius	-	Marigold
Algiers	Medium, Extra Bold	Albertus
NimbusSansNo2	Medium, Bold, Italic, Bold Italic	Arial

Font Name	Family	HP Equivalent
Nimbus Roman No9	Medium, Bold, Italic, Bold Italic	Times New Roman
Nimbus Sans	Medium, Bold, Oblique, Bold Oblique	Helvetica
Nimbus Sans Narrow	Medium, Bold, Oblique, Bold Oblique	Helvetica Narrow
Palladio	Roman, Bold, Italic, Bold Italic	Palatino
URW Gothic	Book, Demi, Book Oblique, Demi Oblique	ITC Avant Garde
URW Bookman	Light, Demi, Light Italic, Demi Italic	ITC Bookman
URW Century Schoolbook	Roman, Bold, Italic, Bold Italic	New Century Schoolbook
Nimbus Roman	Medium, Bold, Italic, Bold Italic	Times
URW Chancery Medium Italic	-	ITC Zapf Chancery Italic
Symbol	-	Symbol
URW Dingbats	-	Wingdings
Dingbats	-	ITC Zapf Dingbats
Standard Symbol	-	SymbolIPS

Available Fonts for PCL (URW)

Scalable Font

Font Name	Family	HP Equivalent	Symbol Set for PCL5
Nimbus Mono	Medium, Bold, Italic, Bold Italic	Courier	1
Letter Gothic	Medium, Bold, Italic	Letter Gothic	1
Nimbus Mono PS	Regular, Bold, Oblique, Bold Oblique	CourierPS	3
Nimbus Roman No4	Medium, Bold, Italic, Bold Italic	CG Times	2
URW Classico	Medium, Bold, Italic, Bold Italic	CG Omega	3
URW Coronet	-	Coronet	3
URW Clarendon Condensed	-	Clarendon Condensed	3
URW Classic Sans	Medium, Bold, Italic, Bold Italic	Univers	2
URW Classic Sans Condensed	Medium, Bold, Italic, Bold Italic	Univers Condensed	3
Antique Olive	Medium, Bold, Italic	Antique Olive	3
Garamond	Antiqua, Halbfett, Kursiv, Kursiv Halbfett	Garamond	3
Mauritius	-	Marigold	3

Font Name	Family	HP Equivalent	Symbol Set for PCL5
Algiers	Medium, Extra Bold	Albertus	3
NimbusSansNo2	Medium, Bold, Italic, Bold Italic	Arial	3
Nimbus Roman No9	Medium, Bold, Italic, Bold Italic	Times New	3
Nimbus Sans	Medium, Bold, Oblique, Bold Oblique	Helvetica	3
Nimbus Sans Narrow	Medium, Bold, Oblique, Bold Oblique	Helvetica Narrow	3
Palladio	Roman, Bold, Italic, Bold Italic	Palatino	3
URW Gothic	Book, Demi, Book Oblique, Demi Oblique	ITC Avant Garde Gothic	3
URW Bookman	Light, Demi, Light Italic, Demi Italic	ITC Bookman	3
URW Century Schoolbook	Roman, Bold, Italic, Bold Italic	New Century Schoolbook	3
Nimbus Roman	Medium, Bold, Italic, Bold Italic	Times	3
URW Chancery Medium Italic	-	ITC Zapf Chancery Medium Italic	3
Symbol	-	Symbol	4
URW Dingbats	-	Wingdings	5
Dingbats	-	ITC Zapf Dingbats	6
Standard Symbol	-	SymbolPS	4
URW David	Medium, Bold	HP David	7
URW Narkis	Medium, Bold	HP Narkis	7
URW Miryam	Medium, Bold, Italic	HP Miryam	7
URW Koufi	Medium, Bold	Koufi	8
URW Naskh	Medium, Bold	Naskh	8
URW Ryadh	Medium, Bold	Ryadh	8

Bitmap Font

Font Name	Symbol Set
Line Printer	9

OCR/Barcode Bitmap Font (for PCL5 only)

Font Name	Family	Symbol Set
OCR A	-	10

Font Name	Family	Symbol Set
OCR B	-	11
Code39	9.37cpi, 4.68cpi	12
EAN/UPC	Medium, Bold	13

Note:

Depending on the print density, or on the quality or color of the paper, OCR A, OCR B, Code39, and EAN/UPC fonts may not be readable. Print a sample and make sure the fonts can be read before printing large quantities.

List of Symbol Sets

Your printer can access a variety of symbol sets. Many of these symbol sets differ only in the international characters specific to each language.

When you are considering which font to use, you should also consider which symbol set to combine with the font.

Note:

Since most software handles fonts and symbols automatically, you will probably never need to adjust the printer's settings. However, if you are writing your own printer control programs, or if you are using older software that cannot control fonts, refer to the following sections for symbol set details.

List of Symbol Sets for PCL 5

Symbol Set Name	Attribute	Font Classification												
		1	2	3	4	5	6	7	8	9	10	11	12	13
Norweg1	0D	✓	✓	✓	-	-	-	-	-	-	-	-	-	-
Roman Extension	0E	-	-	-	-	-	-	-	-	✓	-	-	-	-
Italian	0I	✓	✓	✓	-	-	-	-	-	-	-	-	-	-
ECM94-1	0N	✓	✓	✓	-	-	-	-	-	✓	-	-	-	-
Swedis2	0S	✓	✓	✓	-	-	-	-	-	-	-	-	-	-
ANSI ASCII	0U	✓	✓	✓	-	-	-	✓	✓	-	-	-	-	-
UK	1E	✓	✓	✓	-	-	-	-	-	-	-	-	-	-
French2	1F	✓	✓	✓	-	-	-	-	-	-	-	-	-	-
German	1G	✓	✓	✓	-	-	-	-	-	-	-	-	-	-
Legal	1U	✓	✓	✓	-	-	-	-	-	✓	-	-	-	-
8859-2 ISO	2N	✓	✓	✓	-	-	-	-	-	✓	-	-	-	-
Spanish	2S	✓	✓	✓	-	-	-	-	-	-	-	-	-	-
ISO 8859/4 Latin 4	4N	✓	✓	✓	-	-	-	-	-	-	-	-	-	-

Symbol Set Name	Attribute	Font Classification												
		1	2	3	4	5	6	7	8	9	10	11	12	13
Roman-9	4U	✓	✓	✓	-	-	-	-	-	-	-	-	-	-
PsMath	5M	✓	✓	✓	-	-	-	✓	✓	-	-	-	-	-
8859-9 ISO	5N	✓	✓	✓	-	-	-	-	-	✓	-	-	-	-
WiTurkish	5T	✓	✓	✓	-	-	-	-	-	-	-	-	-	-
MsPublishin	6J	✓	✓	✓	-	-	-	-	-	-	-	-	-	-
VeMath	6M	✓	✓	✓	-	-	-	-	-	-	-	-	-	-
8859-10ISO	6N	✓	✓	✓	-	-	-	-	-	✓	-	-	-	-
DeskTop	7J	✓	✓	✓	-	-	-	-	-	-	-	-	-	-
Math-8	8M	✓	✓	✓	-	-	-	✓	✓	-	-	-	-	-
Roman-8	8U	✓	✓	✓	-	-	-	-	-	✓	-	-	-	-
WiE.Europe	9E	✓	✓	✓	-	-	-	-	-	-	-	-	-	-
Pc1004	9J	✓	✓	✓	-	-	-	-	-	-	-	-	-	-
8859-15ISO	9N	✓	✓	✓	-	-	-	-	-	✓	-	-	-	-
PcTk437	9T	✓	✓	✓	-	-	-	-	-	-	-	-	-	-
Windows	9U	✓	✓	✓	-	-	-	-	-	-	-	-	-	-
PsText	10J	✓	✓	✓	-	-	-	-	-	-	-	-	-	-
IBM-US	10U	✓	✓	✓	-	-	-	-	-	✓	-	-	-	-
IBM-DN	11U	✓	✓	✓	-	-	-	-	-	✓	-	-	-	-
McText	12J	✓	✓	✓	-	-	-	-	-	-	-	-	-	-
PcMultiling	12U	✓	✓	✓	-	-	-	-	-	✓	-	-	-	-
VeInternati	13J	✓	✓	✓	-	-	-	-	-	-	-	-	-	-
PcEur858	13U	✓	✓	✓	-	-	-	-	-	-	-	-	-	-
VeUS	14J	✓	✓	✓	-	-	-	-	-	-	-	-	-	-
PiFont	15U	✓	✓	✓	-	-	-	-	-	-	-	-	-	-
PcE.Europe	17U	✓	✓	✓	-	-	-	-	-	-	-	-	-	-
Unicode 3.0	18N	✓	✓	✓	-	-	-	✓	✓	-	-	-	-	-
WiBALT	19L	✓	✓	✓	-	-	-	-	-	-	-	-	-	-
WiAnsi	19U	✓	✓	✓	-	-	-	-	-	-	-	-	-	-
PcBlit775	26U	✓	✓	✓	-	-	-	-	-	-	-	-	-	-
Pc866Cyr	3R	✓	✓	-	-	-	-	-	-	-	-	-	-	-

Symbol Set Name	Attribute	Font Classification												
		1	2	3	4	5	6	7	8	9	10	11	12	13
Greek8	8G	✓	✓	-	-	-	-	-	-	-	-	-	-	-
WinGrk	9G	✓	✓	-	-	-	-	-	-	-	-	-	-	-
WinCyr	9R	✓	✓	-	-	-	-	-	-	-	-	-	-	-
Pc851Grk	10G	✓	✓	-	-	-	-	-	-	-	-	-	-	-
ISOCyr	10N	✓	✓	-	-	-	-	-	-	✓	-	-	-	-
Pc8Grk	12G	✓	✓	-	-	-	-	-	-	-	-	-	-	-
ISOGrk	12N	✓	✓	-	-	-	-	-	-	-	-	-	-	-
Pc866Ukr	14R	✓	✓	-	-	-	-	-	-	-	-	-	-	-
Hebrew7	0H	✓	-	-	-	-	-	✓	-	-	-	-	-	-
8859-8 ISO	7H	✓	-	-	-	-	-	✓	-	-	-	-	-	-
Hebrew8	8H	✓	-	-	-	-	-	✓	-	-	-	-	-	-
Pc862Heb	15H	✓	-	-	-	-	-	✓	-	-	-	-	-	-
PC-862, Hebrew	15Q	✓	-	-	-	-	-	✓	-	-	-	-	-	-
Arabic8	8V	-	-	-	-	-	-	-	✓	-	-	-	-	-
HPWARA	9V	-	-	-	-	-	-	-	✓	-	-	-	-	-
Pc864Ara	10V	-	-	-	-	-	-	-	✓	-	-	-	-	-
Symbol	19M	-	-	-	✓	-	-	-	-	-	-	-	-	-
Wingdings	579L	-	-	-	-	✓	-	-	-	-	-	-	-	-
ZapfDigrbats	14L	-	-	-	-	-	✓	-	-	-	-	-	-	-
OCR A	0O	-	-	-	-	-	-	-	-	-	✓	-	-	-
OCR B	1O	-	-	-	-	-	-	-	-	-	-	✓	-	-
OCR B Extension	3Q	-	-	-	-	-	-	-	-	-	-	✓	-	-
Code3-9	0Y	-	-	-	-	-	-	-	-	-	-	-	✓	-
EAN/UPC	8Y	-	-	-	-	-	-	-	-	-	-	-	-	✓

Regulatory Information

Standards and Approvals

Standards and Approvals for U.S. Model

Safety	UL60950-1 CAN/CSA-C22 No.60950-1-07
EMC	FCC Part 15 Subpart B Class B CAN ICES-3 (B)/NMB-3 (B)

This equipment contains the following wireless module.

Manufacturer: Seiko Epson Corporation

Type: J26H005

This product conforms to Part 15 of the FCC Rules and RSS-210 of the IC Rules. Epson cannot accept responsibility for any failure to satisfy the protection requirements resulting from a non-recommended modification of the product. Operation is subject to the following two conditions: (1) this device may not cause harmful interference, and (2) this device must accept any interference received, including interference that may cause undesired operation of the device.

To prevent radio interference to the licensed service, this device is intended to be operated indoors and away from windows to provide maximum shielding. Equipment (or its transmit antenna) that is installed outdoors is subject to licensing.

This equipment complies with FCC/IC radiation exposure limits set forth for an uncontrolled environment and meets the FCC radio frequency (RF) Exposure Guidelines in Supplement C to OET65 and RSS-102 of the IC radio frequency (RF) Exposure rules. This equipment should be installed and operated so that the radiator is kept at least 7.9 inches (20 cm) or more away from a person's body (excluding extremities: hands, wrists, feet and ankles).

Standards and Approvals for European Model

The following model is CE/UKCA marked and in compliance with the relevant statutory requirements.

The full text of the declaration of conformity is available at the following website:

<https://www.epson.eu/conformity>

B651E

Frequency Range	Maximum Radio-Frequency Power Transmitted
2400-2483.5 MHz	20 dBm (EIRP)
5150-5250 MHz	20 dBm (EIRP)
5250-5350 MHz	20 dBm (EIRP)
5470-5725 MHz	20 dBm (EIRP)



Standards and Approvals for Australian Model

EMC	AS/NZS CISPR32 Class B
-----	------------------------

Epson hereby declares that the following equipment Models are in compliance with the essential requirements and other relevant provisions of AS/NZS4268:

B651E

Epson cannot accept responsibility for any failure to satisfy the protection requirements resulting from a non-recommended modification of the products.

ZICTA Type Approval for Users in Zambia

See the following website to check the information for ZICTA Type Approval.

<https://support.epson.net/zicta/>

German Blue Angel

See the following website to check whether or not this printer meets the standards for the German Blue Angel.

<http://www.epson.de/blauerengel>

Restrictions on Copying

Observe the following restrictions to ensure the responsible and legal use of the printer.

Copying of the following items is prohibited by law:

- Bank bills, coins, government-issued marketable securities, government bond securities, and municipal securities
- Unused postage stamps, pre-stamped postcards, and other official postal items bearing valid postage
- Government-issued revenue stamps, and securities issued according to legal procedure

Exercise caution when copying the following items:

- Private marketable securities (stock certificates, negotiable notes, checks, etc.), monthly passes, concession tickets, etc.
- Passports, driver's licenses, warrants of fitness, road passes, food stamps, tickets, etc.

Note:

Copying these items may also be prohibited by law.

Responsible use of copyrighted materials:

Printers can be misused by improperly copying copyrighted materials. Unless acting on the advice of a knowledgeable attorney, be responsible and respectful by obtaining the permission of the copyright holder before copying published material.

Administrator Information

Managing the Printer.	217
Product Security Settings.	232
Network Security Settings.	239
Using Epson Open Platform.	272
Epson Remote Services Information.	274

Managing the Printer

Checking Information for a Remote Printer

You can check the following information of the operating printer from **Status** by using Web Config.

Product Status

Check the status, cloud service, product number, MAC address, etc.

If you have registered information in **Administrator Name/Contact Information** on the **Device Management** tab, administrator information is displayed on the Status tab.

Network Status

Check the information of the network connection status, IP address, DNS server, etc.

Usage Status

Check the first day of printings, printed pages, printing count for each language, etc.

Hardware Status

Check the status of each function of the printer.

Panel Snapshot

Display a screen image snapshot that is displayed on the control panel of the device.

Setting the Control Panel

Setup for the printer's control panel. You can set up as follows.

1. Enter the printer's IP address into a browser to access Web Config.

Enter the printer's IP address from a computer that is connected to the same network as the printer.

You can check the IP address of the printer from the following menu.

Settings > General Settings > Network Settings > Network Status > Wired LAN/Wi-Fi Status

2. Enter the administrator password to log in as an administrator.

3. Select in the following order.

Device Management tab > **Control Panel**

4. Set up the following items as necessary.

Language

Select the displayed language on the control panel.

Panel Lock

If you select **ON**, the administrator password is required when you perform an operation that requires the administrator's authority. If the administrator password is not set, panel lock is disabled.

Operation Timeout

If you select **ON**, when you log in as the access control user or administrator, you are automatically logged out and go to the initial screen if there is no activity for a certain period of time.

You can set between 10 seconds and 240 minutes by the second.

Note:

You can also set up from the printer's control panel.

- ❑ *Language* : **Settings > General Settings > Basic Settings > Language**
- ❑ *Panel Lock* : **Settings > General Settings > System Administration > Security Settings > Admin Settings > Lock Setting**
- ❑ *Operation Timeout* : **Settings > General Settings > Basic Settings > Operation Time Out** (You can specify On or Off.)

5. Click OK.

Related Information

- ➔ [“Default Value of the Administrator Password” on page 16](#)

Controlling the Panel Operation

If you enable the Lock Setting, you can lock the items related to the printer's system settings so that users cannot change them.

Target Items of Lock Setting

Control panel menu items that are restricted when the administrator lock is enabled, see the related information.

Locked menus are marked with . Lower level menus will also be locked.

Related Information

- ➔ [“Settings Menu List” on page 184](#)

Managing the Network Connection

You can check or configure the network connection.

Checking or Configuring Basic Network Settings

1. Enter the printer's IP address into a browser to access Web Config.
Enter the printer's IP address from a computer that is connected to the same network as the printer.
You can check the IP address of the printer from the following menu.
Settings > General Settings > Network Settings > Network Status > Wired LAN/Wi-Fi Status
2. Enter the administrator password to log in as an administrator.
3. Select in the following order.
Network tab > **Basic**
4. Set each item.

5. Click **Next**.
A confirmation message is displayed.
6. Click **OK**.
The printer is updated.

Related Information

- ➔ [“Default Value of the Administrator Password” on page 16](#)
- ➔ [“Network Setting Items” on page 219](#)

Network Setting Items

Items	Setting value and Description
Device Name	Display the Device Name. To change the Device Name, enter the new Device Name in the text box.
Location	Enter the Location of the device.
Obtain IP Address	Select the IP Address setting method from Auto or Manual. If you select Manual, you will need to enter the IP address, subnet mask, and so on.
Set using BOOTP	You can specify whether or not to enable Set using BOOTP.
Set using Automatic Private IP Addressing (APIPA)	You can specify whether or not to enable Set using Automatic Private IP Addressing (APIPA).
IP Address	Enter the IP Address. Enter in the format xxx.xxx.xxx.xxx. Enter a number from 0 to 255 for xxx. Make sure that the IP Address is unique and does not conflict with any other device on the network.
Subnet Mask	Enter the Subnet Mask. Enter in the format xxx.xxx.xxx.xxx. Enter a number from 0 to 255 for xxx.
Default Gateway	Enter the Default Gateway. Enter in the format xxx.xxx.xxx.xxx. Enter a number from 0 to 255 for xxx.
DNS Server Setting	Select the DNS Server Setting method from Auto or Manual. Manual is selected when Obtain IP Address is set to Manual.
Primary DNS Server	Enter the Primary DNS Server. Enter in the format xxx.xxx.xxx.xxx. Enter a number from 0 to 255 for xxx.
Secondary DNS Server	Enter the Secondary DNS Server. Enter in the format xxx.xxx.xxx.xxx. Enter a number from 0 to 255 for xxx.
DNS Host Name Setting	Select the DNS Host Name Setting method from Auto or Manual.
DNS Host Name	Display the current DNS Host Name.
DNS Domain Name Setting	Select the DNS Domain Name setting method from Auto or Manual.

Items	Setting value and Description
DNS Domain Name	<p>Enter the DNS Domain Name according to the following rules.</p> <ul style="list-style-type: none"> <input type="checkbox"/> Enter between 2 and 249 characters using "A-Z", "a-z", "0-9", hyphen "-", and a period ".". <input type="checkbox"/> "0-9", hyphen "-", and a period "." cannot be the first character. <input type="checkbox"/> A hyphen "-", and a period "." cannot be the last character. <input type="checkbox"/> Each label in the domain name must be between 1 and 63 characters and separated by a period. <p>The total number of characters of the host name and the domain name must not exceed 251.</p>
Register the network interface address to DNS	<p>You can specify whether or not to enable Register the network interface address to DNS.</p> <p>Enable if you want to register the host name and domain name with the DNS server through a DHCP server that supports dynamic DNS.</p> <p>If you select Enable, you will need to set the host name and domain name.</p>
Proxy Server Setting	<p>You can specify whether or not to use Proxy Server Setting. When this is selected, you need to configure the subsequent proxy server settings.</p>
Proxy Server	<p>Enter the address for the Proxy Server in IPv4 or FQDN format.</p>
Proxy Server Port Number	<p>Enter a number between 1 and 65535.</p>
Proxy Server User Name	<p>Enter the proxy server user name between 0 and 255 characters in ASCII (0x20-0x7E).</p>
Proxy Server Password	<p>Enter the proxy server password between 0 and 255 characters in ASCII (0x20-0x7E).</p>
IPv6 Setting	<p>You can specify whether or not to enable IPv6 Setting.</p>
IPv6 Privacy Extension	<p>You can specify whether or not to enable IPv6 Privacy Extension.</p>
IPv6 DHCP Server Setting	<p>You can specify whether or not to enable IPv6 DHCP Server Setting.</p>
IPv6 Address	<p>When using IPv6 Address, enter in the following format.</p> <ul style="list-style-type: none"> <input type="checkbox"/> xxxx: xxxx: xxxx: xxxx: xxxx: xxxx: xxxx: xxxx / prefix <input type="checkbox"/> xxxx is a hexadecimal number from 1 to 4 digits, and the prefix is a decimal number from 1 to 128. <input type="checkbox"/> If there are consecutive blocks where xxxx is all 0s, it can be omitted as :: (Only one place).
IPv6 Address Default Gateway	<p>When assigning IPv6 Address Default Gateway, enter in the following format.</p> <p>Enter in the following format.</p> <ul style="list-style-type: none"> <input type="checkbox"/> xxxx: xxxx: xxxx: xxxx: xxxx: xxxx: xxxx: xxxx <input type="checkbox"/> xxxx is a hexadecimal number from 1 to 4 digits. <input type="checkbox"/> If there are consecutive blocks where xxxx is all 0s, it can be omitted as :: (Only one place).
IPv6 Link-Local Address	<p>Displays the valid IPv6 Link-Local Address.</p>
IPv6 Stateful Address	<p>Displays the valid IPv6 Stateful Address.</p>

Items	Setting value and Description
IPv6 Stateless Address 1	Displays the valid IPv6 Stateless Address 1.
IPv6 Stateless Address 2	Displays the valid IPv6 Stateless Address 2.
IPv6 Stateless Address 3	Displays the valid IPv6 Stateless Address 3.
IPv6 Primary DNS Server	<p>Enter the IPv6 primary DNS server in the following format.</p> <ul style="list-style-type: none"> <input type="checkbox"/> xxxx: xxxx: xxxx: xxxx: xxxx: xxxx: xxxx: xxxx <input type="checkbox"/> xxxx is a hexadecimal number from 1 to 4 digits. <input type="checkbox"/> If there are consecutive blocks where xxxx is all 0s, it can be omitted as :: (Only one place).
IPv6 Secondary DNS Server	<p>When assigning IPv6 Secondary DNS Server, enter in the following format.</p> <ul style="list-style-type: none"> <input type="checkbox"/> xxxx: xxxx: xxxx: xxxx: xxxx: xxxx: xxxx: xxxx <input type="checkbox"/> xxxx is a hexadecimal number from 1 to 4 digits. <input type="checkbox"/> If there are consecutive blocks where xxxx is all 0s, it can be omitted as :: (Only one place).
IEEE802.11k/v	<p>You can specify whether or not to enable IEEE802.11k/v.</p> <p>For models that support Wi-Fi, this item is displayed when the Wireless LAN Interface is installed.</p>
IEEE802.11r	<p>You can specify whether or not to enable IEEE802.11r.</p> <p>For models that support Wi-Fi, this item is displayed when the Wireless LAN Interface is installed.</p>

Wi-Fi

You can check the Wi-Fi or Wi-Fi Direct connection status.

To display the Wi-Fi Direct status, click Wi-Fi Direct tab.

Note:

For models that support Wi-Fi, this item is displayed when the Wireless LAN Interface is installed.

Setup button

When the Setup button is clicked, the Wi-Fi setup (infrastructure mode) screen is displayed.

Disable Wi-Fi button

When the Disable Wi-Fi button is clicked, the Wi-Fi (infrastructure mode) function is disabled.

If you used to use Wi-Fi (wireless LAN) but no longer need to do so due to a change in connection mode and so on, by removing unnecessary Wi-Fi signals, you can also reduce the load on the printer's standby power usage.

Note:

You can also set up from the printer's control panel.

Settings > General Settings > Network Settings

Configuring Wired LAN Settings

1. Enter the printer's IP address into a browser to access Web Config.
Enter the printer's IP address from a computer that is connected to the same network as the printer.
You can check the IP address of the printer from the following menu.
Settings > General Settings > Network Settings > Network Status > Wired LAN/Wi-Fi Status
2. Enter the administrator password to log in as an administrator.
3. Select in the following order.
Network tab > Wired LAN
4. Set each item.
 - Link Speed & Duplex
Select the communication mode from the list.
 - IEEE 802.3az
You can specify whether or not to enable IEEE 802.3az.
5. Click **Next**.
A confirmation message is displayed.
6. Click **OK**.
The printer is updated.

Related Information

➔ [“Default Value of the Administrator Password” on page 16](#)

Configuring Wi-Fi Direct Settings

You can check or configure the Wi-Fi Direct Settings.

Note:

For models that support Wi-Fi, this item is displayed when the Wireless LAN Interface is installed.

1. Enter the printer's IP address into a browser to access Web Config.
Enter the printer's IP address from a computer that is connected to the same network as the printer.
You can check the IP address of the printer from the following menu.
Settings > General Settings > Network Settings > Network Status > Wired LAN/Wi-Fi Status
2. Enter the administrator password to log in as an administrator.
3. Select in the following order.
Network tab > Wi-Fi Direct

4. Sets each item.

Wi-Fi Direct

You can specify whether or not to enable the Wi-Fi Direct.

SSID

You can change the SSID (Network Name).whether or not to enable

Password

When changing the Wi-fi Direct password, enter a new password.

Frequency Range

Select the frequency range to be used in Wi-Fi Direct.

IP Address

Select the IP Address setting method from Auto or Manual.

5. Click **Next**.

A confirmation message is displayed.

Note:

To reset the Wi-Fi Direct settings, click the *Restore Default Settings* button.

6. Click **OK**.

The printer is updated.

Related Information

➔ [“Default Value of the Administrator Password” on page 16](#)

Configuring Email Notifications When Events Occur

You can configure email notifications so that an email is sent to the specified addresses when events such as printing stopping or printer errors occur. You can register up to five destinations and set the notification settings for each destination.

To use this function, you need to set up the mail server before setting up notifications. Set up the email server on the network to which you want to send the email.

1. Enter the printer's IP address into a browser to access Web Config.

Enter the printer's IP address from a computer that is connected to the same network as the printer.

You can check the IP address of the printer from the following menu.

Settings > General Settings > Network Settings > Network Status > Wired LAN/Wi-Fi Status

2. Enter the administrator password to log in as an administrator.

3. Select in the following order.

Device Management tab > **Email Notification**

4. Set the subject of email notification.

Select the contents displayed on the subject from the two pull-down menus.

The selected contents are displayed next to **Subject**.

- The same contents cannot be set on left and right.
 - When the number of characters in **Location** exceeds 32 bytes, characters exceeding 32 bytes are omitted.
5. Enter the email address for sending the notification email.
Use A-Z a-z 0-9 ! # \$ % & ' * + - . / = ? ^ _ { | } ~ @, and enter between 1 and 255 characters.
 6. Select the language for the email notifications.
 7. Select the checkbox on the event for which you want to receive a notification.
The number of **Notification Settings** is linked to the destination number of **Email Address Settings**.

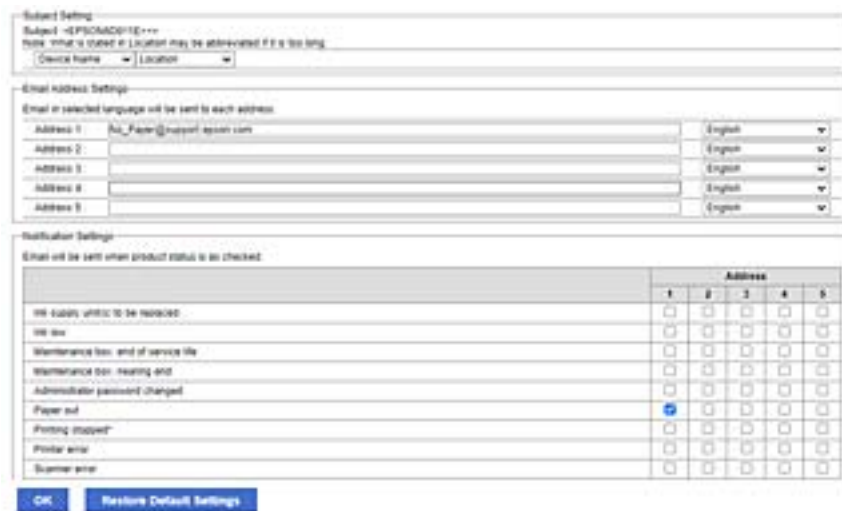

If you want a notification sent to the email address set for number 1 in **Email Address Settings** when the printer is out of paper, select the checkbox column **1** in line **Paper out**.

8. Click **OK**.
Confirm that an email notification will be sent by causing an event.
Example : Print by specifying the Paper Source where paper is not set.

Related Information

- ➔ “Default Value of the Administrator Password” on page 16
- ➔ “Configuring a Mail Server” on page 59

Items for Email Notification

Items	Settings and Explanation
Ink supply unit(s) to be replaced	Notice when the ink is expended.
Ink low	Notice when the ink is nearing expended.
Maintenance box: end of service life	Notice when the maintenance box is full.
Maintenance box: nearing end	Notice when the maintenance box is nearing full.

Items	Settings and Explanation
Administrator password changed	Notice when administrator password has been changed.
Paper out	Notice when the paper-out error has occurred in the specified paper source..
Printing stopped	Notice when the printing is stopped due to paper jam or paper cassette not set.
Printer error	Notice when the printer error has occurred.
Wi-Fi failure	Notice when the error of the wireless LAN interface has occurred.
Built-in SD card failure	Notice when the error of the built-in SD card has occurred.
PDL board failure	Notice when the error of the PDL substrate has occurred.

Related Information

➔ [“Configuring Email Notifications When Events Occur” on page 223](#)

Power Saving Settings During Inactivity

You can set up the time to shift to the power saving mode or to turn the power off when the printer’s control panel is not operated for a certain period of time. Set the time depending on your usage environment.

- Enter the printer's IP address into a browser to access Web Config.
Enter the printer's IP address from a computer that is connected to the same network as the printer.
You can check the IP address of the printer from the following menu.
Settings > General Settings > Network Settings > Network Status > Wired LAN/Wi-Fi Status
- Enter the administrator password to log in as an administrator.
- Select in the following order.
Device Management tab > Power Saving
- Enter the administrator password to log in as an administrator.
- Set up the following items as necessary.
 - Sleep Timer
Enter the time to switch power saving mode when inactivity occurs.

Note:

You can also set up from the printer’s control panel.

Settings > General Settings > Basic Settings > Sleep Timer

- Power Off Timer or Power Off If Inactive

Select a time to automatically turn off the printer after it has been inactive for a specific time.

Note:

You can also set up from the printer’s control panel.

Settings > General Settings > Basic Settings > Power Off Timer or Power Off Settings

Power Off If Disconnected

Select this setting to turn the printer off after a specified period of time when all ports including the USB port are disconnected. This feature may not be available depending on your region.

See the following website for the specified period of time.

<https://www.epson.eu/energy-consumption>

Note:

You can also set up from the printer's control panel.

Settings > General Settings > Basic Settings > Power Off Settings > Power Off If Disconnected

6. Click OK.

Related Information

➔ [“Default Value of the Administrator Password” on page 16](#)

Backing Up and Importing Printer Settings

You can export the setting value set from Web Config to the file. You can import the exported file to the printer by using Web Config. You can use it for backing up the setting values, replacing the printer, etc.

The exported file cannot be edited because it is exported as a binary file.

Export the settings

Export the setting for the printer.

1. Enter the printer's IP address into a browser to access Web Config.

Enter the printer's IP address from a computer that is connected to the same network as the printer.

You can check the IP address of the printer from the following menu.

Settings > General Settings > Network Settings > Network Status > Wired LAN/Wi-Fi Status

2. Enter the administrator password to log in as an administrator.

3. Select in the following order.

Device Management tab > Export and Import Setting Value > Export

4. Select the settings that you want to export.

Select the settings you want to export. If you select the parent category, subcategories are also selected.

However, subcategories that cause errors by duplicating within the same network (such as IP addresses and so on) cannot be selected.

5. Enter a password to encrypt the exported file.

You need the password to import the file. Leave this blank if you do not want to encrypt the file.

6. Click **Export**.



Important:

*If you want to export the printer's network settings such as the device name and IPv6 address, select **Enable to select the individual settings of device** and select more items. Only use the selected values for the replacement printer.*

Related Information

- ➔ [“Default Value of the Administrator Password” on page 16](#)

Import the settings

Import the exported Web Config file to the printer.



Important:

When importing values that include individual information such as a printer name or IP address, make sure the same IP address does not exist on the same network.

1. Enter the printer's IP address into a browser to access Web Config.
Enter the printer's IP address from a computer that is connected to the same network as the printer.
You can check the IP address of the printer from the following menu.
Settings > General Settings > Network Settings > Network Status > Wired LAN/Wi-Fi Status
2. Enter the administrator password to log in as an administrator.
3. Select in the following order.
Device Management tab > Export and Import Setting Value > Import
4. Select the exported file, and then enter the encrypted password.
5. Click **Next**.
6. Select the settings that you want to import, and then click **Next**.
7. Click **OK**.

The settings are applied to the printer.

Related Information

- ➔ [“Default Value of the Administrator Password” on page 16](#)

Updating the Firmware

Updating the Printer's Firmware using the Control Panel

If the printer can be connected to the Internet, you can update the printer's firmware using the control panel. You can also set the printer to regularly check for firmware updates and notify you if any are available.

1. Select **Settings** on the home screen.

To select an item, use the ▲ ▼ ◀▶ buttons, and then press the OK button.

2. Select **General Settings > System Administration > Firmware Update > Update**.

Note:

Select **Notification > On** to set the printer to regularly check for available firmware updates.

3. Check the message displayed on the screen and start searching for available updates.
4. If a message is displayed on the LCD screen informing you that a firmware update is available, follow the on-screen instructions to start the update.



Important:

- ❑ Do not turn off or unplug the printer until the update is complete; otherwise, the printer may malfunction.
- ❑ If the firmware update is not completed or is unsuccessful, the printer does not start up normally and "Recovery Mode" is displayed on the LCD screen the next time the printer is turned on. In this situation, you need to update the firmware again using a computer. Connect the printer to the computer with a USB cable. While "Recovery Mode" is displayed on the printer, you cannot update the firmware over a network connection. On the computer, access your local Epson website, and then download the latest printer firmware. See the instructions on the website for the next steps.

Updating the Printer's Firmware Automatically

You can set the firmware to update automatically when the printer is connected to the Internet.

When the administrator lock is enabled, only the administrator can execute this function. Contact your printer administrator for assistance.

1. Select **Settings** on the printer's control panel.

To select an item, use the ▲ ▼ ◀▶ buttons, and then press the OK button.

2. Select **General Settings > System Administration > Firmware Update**.

3. Select **Automatic Firmware Update** to display the settings screen.

4. Select **Automatic Firmware Update** to enable this feature.

Select **Agree** on the confirmation screen to return to the settings screen.

5. Set the day and time for the update, and then select **OK**.

Note:

You can select multiple days of the week, but you cannot specify the time for each day of the week.

Setup is complete when the connection to the server is confirmed.

 **Important:**

- ❑ Do not turn off or unplug the printer until the update is complete. The next time you turn on the printer, "Recovery Mode" may be displayed on the LCD screen and you may not be able to operate the printer.
- ❑ If "Recovery Mode" is displayed, follow the steps below to update the firmware again.
 1. Connect the computer and the printer using a USB cable. (You cannot perform updates in recovery mode over a network.)
 2. Download the latest firmware from the Epson website and start updating. For details, see "Update method" on the download page.

Note:

You can set to update the firmware automatically from Web Config. Select the **Device Management** tab > **Automatic Firmware Update**, enable the settings, and then set the day of the week and time.

Updating Firmware Using Web Config

When the printer can connect to the Internet, you can update the firmware from Web Config.

1. Enter the printer's IP address into a browser to access Web Config.

Enter the printer's IP address from a computer that is connected to the same network as the printer.
You can check the IP address of the printer from the following menu.

Settings > General Settings > Network Settings > Network Status > Wired LAN/Wi-Fi Status
2. Enter the administrator password to log in as an administrator.
3. Select in the following order.

Device Management tab > **Firmware Update**
4. Click **Start**, and then follow the on-screen instructions.

The firmware confirmation starts, and the firmware information is displayed if the updated firmware exists.

Note:

You can also update the firmware using Epson Device Admin. You can visually confirm the firmware information on the device list. It is useful when you want to update multiple devices' firmware. See the Epson Device Admin guide or help for more details.

Updating Firmware without Connecting to the Internet

You can download the device's firmware from Epson website on the computer, and then connect the device and the computer by USB cable to update the firmware. If you cannot update over the network, try this method.

1. Access Epson website and download the firmware.
2. Connect the computer that contains the downloaded firmware to the printer by USB cable.
3. Double-click the downloaded .exe file.

Epson Firmware Updater starts.

4. Follow the on-screen instructions.

Synchronizing the Date and Time with Time Server

When synchronizing with the time server (NTP server), you can synchronize the time of the printer and the computer on the network. The time server may be operated within the organization or published on the Internet.

When using the CA certificate or Kerberos authentication, time-related trouble can be prevented by synchronizing with the time server.

1. Enter the printer's IP address into a browser to access Web Config.

Enter the printer's IP address from a computer that is connected to the same network as the printer.

You can check the IP address of the printer from the following menu.

Settings > General Settings > Network Settings > Network Status > Wired LAN/Wi-Fi Status

2. Enter the administrator password to log in as an administrator.

3. Select in the following order.

Device Management tab > **Date and Time** > **Time Server**.

4. Select **Use** for **Use Time Server**.

5. Enter the time server address for **Time Server Address**.

You can use IPv4, IPv6 or FQDN format. Enter 252 characters or less. If you do not specify this, leave it blank.

6. Enter **Update Interval (min)**.

You can set up to 10,080 minutes by the minute.

7. Click **OK**.

Note:

You can confirm the connection status with the time server on **Time Server Status**.

Related Information

➔ [“Default Value of the Administrator Password” on page 16](#)

Clearing Internal Memory Data

You can delete the printer's internal memory data, such as downloaded fonts and macros for PCL printing, or jobs for password printing.

Note:

You can also set up from the printer's control panel.

Settings > General Settings > System Administration > Clear Internal Memory Data

1. Enter the printer's IP address into a browser to access Web Config.

Enter the printer's IP address from a computer that is connected to the same network as the printer.

You can check the IP address of the printer from the following menu.

Settings > General Settings > Network Settings > Network Status > Wired LAN/Wi-Fi Status

2. Enter the administrator password to log in as an administrator.
3. Select in the following order.
Device Management tab > **Clear Internal Memory Data**
4. Click **Delete** for **PDL Font, Macro, and Working Area**.

Configuring Periodic Cleaning

You can make settings to perform periodic cleaning of the print head.

1. Enter the printer's IP address into a browser to access Web Config.
Enter the printer's IP address from a computer that is connected to the same network as the printer.
You can check the IP address of the printer from the following menu.
Settings > General Settings > Network Settings > Network Status > Wired LAN/Wi-Fi Status
2. Enter the administrator password to log in as an administrator.
3. Select in the following order.
Device Management tab > **Periodic Cleaning**
4. Select an option from the list.
5. When selecting **Schedule**, specify the time to perform cleaning from the list.
6. Click **OK**.

Related Information

- ➔ [“Default Value of the Administrator Password” on page 16](#)
- ➔ [“Periodic Cleaning:” on page 194](#)

Controlling the Power Supply to the Printer Using Web Config

You can turn off or restart the printer from a computer using Web Config even when the computer is located remotely away from the printer.

1. Enter the printer's IP address into a browser to access Web Config.
Enter the printer's IP address from a computer that is connected to the same network as the printer.
You can check the IP address of the printer from the following menu.
Settings > General Settings > Network Settings > Network Status > Wired LAN/Wi-Fi Status
2. Enter the administrator password to log in as an administrator.
3. Select in the following order.
Device Management tab > **Power**

4. Select **Power Off** or **Reboot**
5. Click **Execute**.

Related Information

➔ [“Default Value of the Administrator Password” on page 16](#)

Restore Default Settings

You can select the network settings or other settings stored in the printer and restore these settings to their defaults.

1. Enter the printer's IP address into a browser to access Web Config.
Enter the printer's IP address from a computer that is connected to the same network as the printer.
You can check the IP address of the printer from the following menu.
Settings > General Settings > Network Settings > Network Status > Wired LAN/Wi-Fi Status
2. Enter the administrator password to log in as an administrator.
3. Select in the following order.
Device Management tab > **Restore Default Settings**
4. Select an option from the list.
5. Click **Execute**.
Follow the on-screen instructions.

Related Information

➔ [“Default Value of the Administrator Password” on page 16](#)

Product Security Settings

Restricting Available Features

You can register user accounts on the printer, link them with functions, and control functions that users can use.

When you register the authentication information to the printer driver, you will be able to print from the computer. For details of the driver settings, see the driver's help or manual.

Creating the User Account

Create the user account for access control.

1. Enter the printer's IP address into a browser to access Web Config.
Enter the printer's IP address from a computer that is connected to the same network as the printer.

You can check the IP address of the printer from the following menu.

Settings > General Settings > Network Settings > Network Status > Wired LAN/Wi-Fi Status

2. Enter the administrator password to log in as an administrator.

3. Select in the following order.

Product Security tab > **Access Control Settings** > **User Settings**

4. Click **Add** for the number you want to register.



Important:

When using the printer with the authentication system of Epson or other companies, register the user name of the restriction setting in number 2 to number 10.

Application software such as the authentication system uses number one, so that the user name is not displayed on the printer's control panel.

5. Set each item.

User Name :

Enter the name displayed on the user name list between 1 and 14 characters long using alphanumeric characters.

Password :

Enter a password between 0 and 20 characters long in ASCII (0x20-0x7E). When initializing the password, leave it blank.

Select the check box to enable or disable each function.

Select the function that you permit to use.

6. Click **Apply**.

Return to the user setting list after a specific length of time.

Check that the user name you registered on **User Name** is displayed and changed **Add** to **Edit**.

Related Information

➔ [“Default Value of the Administrator Password” on page 16](#)

Editing the User Account

Edit the account registered to access control.

1. Enter the printer's IP address into a browser to access Web Config.

Enter the printer's IP address from a computer that is connected to the same network as the printer.

You can check the IP address of the printer from the following menu.

Settings > General Settings > Network Settings > Network Status > Wired LAN/Wi-Fi Status

2. Enter the administrator password to log in as an administrator.

3. Select in the following order.

Product Security tab > **Access Control Settings** > **User Settings**

4. Click **Edit** for the number you want to edit.
5. Change each item.
6. Click **Apply**.
Return to the user setting list after a specific length of time.

Related Information

➔ [“Default Value of the Administrator Password” on page 16](#)

Deleting the User Account

Delete the account registered to access control.

1. Enter the printer's IP address into a browser to access Web Config.
Enter the printer's IP address from a computer that is connected to the same network as the printer.
You can check the IP address of the printer from the following menu.
Settings > General Settings > Network Settings > Network Status > Wired LAN/Wi-Fi Status
2. Enter the administrator password to log in as an administrator.
3. Select in the following order.
Product Security tab > Access Control Settings > User Settings
4. Click **Edit** for the number you want to delete.
5. Click **Delete**.



Important:

*When clicking **Delete**, the user account will be deleted without a confirmation message. Take care when deleting the account.*

Return to the user setting list after a specific length of time.

Related Information

➔ [“Default Value of the Administrator Password” on page 16](#)

Enabling Access Control

When enabling access control, only the registered user will be able to use the printer.

Note:

When Access Control Settings is enabled, you need to notify the user of their account information.

1. Enter the printer's IP address into a browser to access Web Config.
Enter the printer's IP address from a computer that is connected to the same network as the printer.
You can check the IP address of the printer from the following menu.

Settings > General Settings > Network Settings > Network Status > Wired LAN/Wi-Fi Status

2. Enter the administrator password to log in as an administrator.

3. Select in the following order.

Product Security tab > **Access Control Settings** > **Basic**

4. Select **Enables Access Control**.

If you enable Access Control and want to print from smart devices that do not have authentication information, select **Allow printing and scanning without authentication information from a computer**.

5. Click **OK**.

Related Information

➔ [“Default Value of the Administrator Password” on page 16](#)

➔ [“Menu Options for the Printer Driver” on page 82](#)

Restricting USB Connections

You can disable the interface that is used to connect the device to the printer. Make the restriction settings to restrict printing other than via network.

Note:

You can also make the restriction settings on the printer's control panel.

*PC Connection via USB : **Settings > General Settings > Printer Settings > PC Connection via USB***

1. Enter the printer's IP address into a browser to access Web Config.

Enter the printer's IP address from a computer that is connected to the same network as the printer.

You can check the IP address of the printer from the following menu.

Settings > General Settings > Network Settings > Network Status > Wired LAN/Wi-Fi Status

2. Enter the administrator password to log in as an administrator.

3. Select in the following order.

Product Security tab > **External Interface**

4. Select **Disable** on the functions you want to set.

Select **Enable** when you want to cancel controlling.

PC connection via USB

You can restrict the usage of the USB connection from the computer. If you want to restrict it, select **Disable**.

5. Click **OK**.

6. Check that the disabled port cannot be used.

PC Connection via USB

If the driver was installed on the computer

Connect the printer to the computer using a USB cable, and then confirm that the printer does not print.

If the driver was not installed on the computer

Windows:

Open the device manager and keep it, connect the printer to the computer using a USB cable, and then confirm that the device manager's display contents stays unchanged.

Mac OS:

Connect the printer to the computer using a USB cable, and then confirm that the printer is not listed if you want to add the printer from **Printers & Scanners**.

Related Information

➔ [“Default Value of the Administrator Password” on page 16](#)

Encrypting the Password

Password encryption allows you to encrypt confidential information (all passwords, certificate private keys) stored in the printer.

1. Enter the printer's IP address into a browser to access Web Config.
Enter the printer's IP address from a computer that is connected to the same network as the printer.
You can check the IP address of the printer from the following menu.

Settings > General Settings > Network Settings > Network Status > Wired LAN/Wi-Fi Status

2. Enter the administrator password to log in as an administrator.
3. Select in the following order.

Product Security tab > Password Encryption

Note:

You can also set up from the printer's control panel.

Settings > General Settings > System Administration > Security Settings > Password Encryption

4. Select **ON** to enable encryption.
5. Click **OK**.

Related Information

➔ [“Default Value of the Administrator Password” on page 16](#)

Using the Audit Log Feature

You can enable the Audit Log feature or export log data.

Checking the audit logs periodically can help to identify improper usage early on and trace possible security issues.

1. Enter the printer's IP address into a browser to access Web Config.
Enter the printer's IP address from a computer that is connected to the same network as the printer.
You can check the IP address of the printer from the following menu.

Settings > General Settings > Network Settings > Network Status > Wired LAN/Wi-Fi Status

2. Enter the administrator password to log in as an administrator.

3. Select in the following order.

Product Security tab > **Audit Log**

4. Change the settings as necessary.

Audit log setting

Select **ON**, and then click **OK** to enable this feature.

Note:

You can also set up from the printer's control panel.

Settings > General Settings > System Administration > Security Settings > Audit Log

Exports the audit logs to the CSV file.

Click **Export** to export the log as a CSV file.

Deletes all audit logs.

Click **Delete** to delete all log data.

Related Information

➔ [“Default Value of the Administrator Password” on page 16](#)

Restricting File Operations from PDL

This feature protects files from unauthorized PDL operations.

1. Enter the printer's IP address into a browser to access Web Config.

Enter the printer's IP address from a computer that is connected to the same network as the printer.

You can check the IP address of the printer from the following menu.

Settings > General Settings > Network Settings > Network Status > Wired LAN/Wi-Fi Status

2. Enter the administrator password to log in as an administrator.

3. Select in the following order.

Product Security tab > **File Operations from PDL**

4. Sets whether or not allow **File Operations from PDL**.

5. Click **OK**.

Related Information

➔ [“Default Value of the Administrator Password” on page 16](#)

Changing the Administrator Password Using Web Config

You can set the administrator password using Web Config.

Changing the password prevents unauthorized reading or modification of the information stored on the device, such as ID, password, network settings, etc. It also reduces a wide range of security risks, such as information leaks in network environments and security policies.

1. Enter the printer's IP address into a browser to access Web Config.
Enter the printer's IP address from a computer that is connected to the same network as the printer.
You can check the IP address of the printer from the following menu.
Settings > General Settings > Network Settings > Network Status > Wired LAN/Wi-Fi Status
2. Enter the administrator password to log in as an administrator.
3. Select in the following order.
Product Security tab > **Change Administrator Password**
4. Enter the current password in **Current password**.
5. Enter the new password in **New Password** and in **Confirm New Password**. Enter the user name, if necessary.
6. Click **OK**.

Note:

To restore the administrator password to the initial password, click **Restore Default Settings** on the **Change Administrator Password** screen.

Related Information

➔ [“Default Value of the Administrator Password” on page 16](#)

Enabling Program Verification on Start Up

If you enable the Program Verification feature, the printer performs verification at start up to check if unauthorized third parties have tampered with the program. If any issues are detected, the printer does not start.

1. Enter the printer's IP address into a browser to access Web Config.
Enter the printer's IP address from a computer that is connected to the same network as the printer.
You can check the IP address of the printer from the following menu.
Settings > General Settings > Network Settings > Network Status > Wired LAN/Wi-Fi Status
2. Enter the administrator password to log in as an administrator.
3. Select in the following order.

Product Security tab > **Program Verification on Start Up**

Note:

You can also set up from the printer's control panel.

Settings > General Settings > System Administration > Security Settings > Program Verification on Start Up

4. Select **ON** to enable **Program Verification on Start Up**.
5. Click **OK**.

Related Information

➔ [“Default Value of the Administrator Password” on page 16](#)

Network Security Settings

Controlling Using Protocols

You can print using a variety of pathways and protocols.

You can lower unintended security risks by restricting printing from specific pathways or by controlling the available functions.

Follow the steps below to configure the protocol settings.

1. Enter the printer's IP address into a browser to access Web Config.
Enter the printer's IP address from a computer that is connected to the same network as the printer.
You can check the IP address of the printer from the following menu.
Settings > General Settings > Network Settings > Network Status > Wired LAN/Wi-Fi Status
2. Enter the administrator password to log in as an administrator.
3. Select in the following order.
Network Security tab > **Protocol**
4. Configure each item.
5. Click **Next**.
6. Click **OK**.
The settings are applied to the printer.

Related Information

- ➔ [“Default Value of the Administrator Password” on page 16](#)
- ➔ [“Protocols you can Enable or Disable” on page 239](#)
- ➔ [“Protocol Setting Items” on page 240](#)

Protocols you can Enable or Disable

Protocol	Description
Bonjour Settings	You can specify whether to use Bonjour. Bonjour is used to search for devices, print, and so on.

Protocol	Description
iBeacon Settings	You can enable or disable the iBeacon transmission function. When enabled, you can search for the printer from iBeacon-enabled devices.
SLP Settings	You can enable or disable the SLP function. SLP is used for network searching in EpsonNet Config.
WSD Settings	You can enable or disable the WSD function. When this is enabled, you can add WSD devices, and print from the WSD port.
LLTD Settings	You can enable or disable the LLTD function. When this is enabled, it is displayed on the Windows network map.
LLMNR Settings	You can enable or disable the LLMNR function. When this is enabled, you can use name resolution without NetBIOS even if you cannot use DNS.
LPR Settings	You can specify whether or not to allow LPR printing. When this is enabled, you can print from the LPR port.
RAW(Port9100) Settings	You can specify whether or not to allow printing from the RAW port (Port 9100). When this is enabled, you can print from the RAW port (Port 9100).
RAW(Custom Port) Settings	You can specify whether or not to allow printing from the RAW port (custom port). When this is enabled, you can print from the RAW port (custom port).
IPP Settings	You can enable or disable the IPP function. When enabled, you will be able to print over the Internet. It is also displayed when searching for devices on the network.
FTP Settings	You can specify whether or not to allow FTP printing. When this is enabled, you can print over an FTP server.
SNMPv1/v2c Settings	You can specify whether or not to enable SNMPv1/v2c. This is used to set up devices, monitoring, and so on.
SNMPv3 Settings	You can specify whether or not to enable SNMPv3. This is used to set up encrypted devices, monitoring, etc.

Related Information

- ➔ [“Controlling Using Protocols” on page 239](#)
- ➔ [“Protocol Setting Items” on page 240](#)

Protocol Setting Items

Bonjour Settings

Items	Setting value and Description
Use Bonjour	Select this to search for or use devices through Bonjour.
Bonjour Name	Displays the Bonjour name.
Bonjour Service Name	Displays the Bonjour service name.
Location	Displays the Bonjour location name.
Top Priority Protocol	Select the top priority protocol for Bonjour print.

Items	Setting value and Description
Wide-Area Bonjour	Set whether to use Wide-Area Bonjour.

iBeacon Settings

Items	Setting value and Description
Enable iBeacon Transmission	Select this to enable the iBeacon transmission function.

SLP Settings

Items	Setting value and Description
Enable SLP	Select this to enable the SLP function. This is used such as network searching in EpsonNet Config.

WSD Settings

Items	Setting value and Description
Enable WSD	Select this to enable adding devices using WSD, and print from the WSD port. If you do not want this product to search for devices, disable this item and disable the Enable IPP item.
Printing Timeout (sec)	Enter the communication timeout value for WSD printing between 3 to 3,600 seconds.
Device Name	Displays the WSD device name.
Location	Displays the WSD location name.

LLTD Settings

Items	Setting value and Description
Enable LLTD	Select this to enable LLTD. The printer is displayed in the Windows network map.
Device Name	Displays the LLTD device name.

LLMNR Settings

Items	Setting value and Description
Enable LLMNR	Select this to enable LLMNR. You can use name resolution without NetBIOS even if you cannot use DNS.

LPR Settings

Items	Setting value and Description
Allow LPR Port Printing	Select to allow printing from the LPR port.

Items	Setting value and Description
Printing Timeout (sec)	Enter the timeout value for LPR printing between 0 to 3,600 seconds. If you do not want to timeout, enter 0.

RAW(Port9100) Settings

Items	Setting value and Description
Allow RAW(Port9100) Printing	Select to allow printing from the RAW port (Port 9100).
Printing Timeout (sec)	Enter the timeout value for RAW (Port 9100) printing between 0 to 3,600 seconds. If you do not want to timeout, enter 0.

RAW(Custom Port) Settings

Items	Setting value and Description
Allow RAW(Custom Port) Printing	Select to allow printing from the RAW port (custom port).
Port Number	Enter the port number for RAW printing between 1024 and 65535 (except for 9100, 1865, 2968).
Printing Timeout (sec)	Enter the timeout value for RAW (custom port) printing between 0 to 3,600 seconds. If you do not want to timeout, enter 0.

IPP Settings

Items	Setting value and Description
Enable IPP	Select to enable IPP communication. When enabled, you will be able to print over the Internet. It is also displayed when searching for devices on the network. Only printers that support IPP are displayed.
Allow Non-secure Communication	Select Allowed to allow the printer to communicate without any security measures (IPP).
Communication Timeout (sec)	Enter the timeout value for IPP printing between 0 to 3,600 seconds.
Require PIN Code when using IPP printing	Select whether or not to require a PIN code when using IPP printing. If you select Yes , IPP print jobs without PIN codes are not saved in the printer.
URL(Network)	Displays IPP URLs (http and https) when the printer is connected to the network. The URL is a combined value of the printer's IP address, Port number, and IPP printer name.
URL(Wi-Fi Direct)	Displays IPP URLs (http and https) when the printer is connected by Wi-Fi Direct. The URL is a combined value of the printer's IP address, Port number, and IPP printer name.
Printer Name	Displays the IPP printer name.
Location	Displays the IPP location.

FTP Settings

Items	Setting value and Description
Enable FTP Server	Select to enable FTP printing. Only printers that support FTP printing are displayed.
Communication Timeout (sec)	Enter the timeout value for FTP communication between 0 to 3,600 seconds. If you do not want to timeout, enter 0.

SNMPv1/v2c Settings

Items	Setting value and Description
Enable SNMPv1	SNMPv1 is enabled when the box is checked.
Enable SNMPv2c	SNMPv2c is enabled when the box is checked.
Access Authority	Set the access authority when SNMPv1 or SNMPv2c is enabled. Select Read Only or Read/Write .
Community Name (Read Only)	Enter 0 to 32 ASCII (0x20 to 0x7E) characters.
Community Name (Read/Write)	Enter 0 to 32 ASCII (0x20 to 0x7E) characters.
Allow access from Epson tools	Set whether or not to allow information to be written by Epson tools such as a Epson Device Admin.

SNMPv3 Settings

Items	Setting value and Description
Enable SNMPv3	SNMPv3 is enabled when the box is checked.
User Name	Enter between 1 and 32 characters using 1 byte characters.
Authentication Settings	
Algorithm	Select an algorithm for an authentication for SNMPv3.
Password	Enter the password for an authentication for SNMPv3. Enter between 8 and 32 characters in ASCII (0x20-0x7E). If you do not specify this, leave it blank.
Confirm Password	Enter the password you configured for confirmation.
Encryption Settings	
Algorithm	Select an algorithm for an encryption for SNMPv3.
Password	Enter the password for an encryption for SNMPv3. Enter between 8 and 32 characters in ASCII (0x20-0x7E). If you do not specify this, leave it blank.
Confirm Password	Enter the password you configured for confirmation.
Context Name	Enter within 32 characters or less in Unicode (UTF-8). If you do not specify this, leave it blank. The number of characters that can be entered varies depending on the language.

Related Information

- ➔ [“Controlling Using Protocols” on page 239](#)
- ➔ [“Protocols you can Enable or Disable” on page 239](#)

Using a Digital Certificate

About Digital Certification

CA-signed Certificate

This is a certificate signed by the CA (Certificate Authority.) You can obtain it to apply to the Certificate Authority. This certificate certifies the existence of the printer and is used for SSL/TLS communication so that you can ensure the safety of data communication.

When it is used for SSL/TLS communication, it is used as a server certificate.

When it is set to IPsec/IP Filtering or IEEE802.1x communication, it is used as a client certificate.

CA Certificate

This is a certificate that is in chain of the CA-signed Certificate, also called the intermediate CA certificate. It is used by the web browser to validate the path of the printer's certificate when accessing the server of the other party or Web Config.

For the CA Certificate, set when to validate the path of server certificate accessing from the printer. For the printer, set to certify the path of the CA-signed Certificate for SSL/TLS connection.

You can obtain the CA certificate of the printer from the Certification Authority where the CA certificate is issued.

Also, you can obtain the CA certificate used to validate the server of the other party from the Certification Authority that issued the CA-signed Certificate of the other server.

Self-signed Certificate

This is a certificate that the printer signs and issues itself. It is also called the root certificate. Because the issuer certifies itself, it is not reliable and cannot prevent impersonation.

Use it when making the security setting and performing simple SSL/TLS communication without the CA-signed Certificate.

If you use this certificate for an SSL/TLS communication, a security alert may be displayed on a web browser because the certificate is not registered on a web browser. You can use the Self-signed Certificate only for an SSL/TLS communication.

Related Information

- ➔ [“Updating a Self-signed Certificate” on page 248](#)
- ➔ [“Configuring a CA Certificate” on page 249](#)

Configuring a CA-signed Certificate

Obtaining a CA-signed Certificate

To obtain a CA-signed certificate, create a CSR (Certificate Signing Request) and apply it to certificate authority. You can create a CSR using Web Config and a computer.

Follow the steps to create a CSR and obtain a CA-signed certificate using Web Config. When creating a CSR using Web Config, a certificate is the PEM/DER format.

1. Enter the printer's IP address into a browser to access Web Config.

Enter the printer's IP address from a computer that is connected to the same network as the printer.

You can check the IP address of the printer from the following menu.

Settings > General Settings > Network Settings > Network Status > Wired LAN/Wi-Fi Status

2. Enter the administrator password to log in as an administrator.

3. Select in the following order.

Network Security tab. > **SSL/TLS > Certificate** or **IPsec/IP Filtering > Client Certificate** or **IEEE802.1X > Client Certificate**

Whatever you choose, you can obtain the same certificate and use it in common.

4. Click **Generate** of **CSR**.

A CSR creating page is opened.

5. Enter a value for each item.

Note:

Available key length and abbreviations vary by a certificate authority. Create a request according to rules of each certificate authority.

6. Click **OK**.

A completion message is displayed.

7. Select the **Network Security** tab. Next, select **SSL/TLS > Certificate**, or **IPsec/IP Filtering > Client Certificate** or **IEEE802.1X > Client Certificate**.

8. Click one of the download buttons of **CSR** according to a specified format by each certificate authority to download a CSR to a computer.



Important:

Do not generate a CSR again. If you do so, you may not be able to import an issued CA-signed Certificate.

9. Send the CSR to a certificate authority and obtain a CA-signed Certificate.

Follow the rules of each certificate authority on sending method and form.

10. Save the issued CA-signed Certificate to a computer connected to the printer.

Obtaining a CA-signed Certificate is complete when you save a certificate to a destination.

Related Information

➔ [“Default Value of the Administrator Password” on page 16](#)

CSR Setting Items

Items	Settings and Explanation
Key Length	Select a key length for a CSR.
Common Name	<p>You can enter between 1 and 128 characters. If this is an IP address, it should be a static IP address. You can enter 1 to 5 IPv4 addresses, IPv6 addresses, host names, FQDNs by separating them with commas.</p> <p>The first element is stored to the common name, and other elements are stored to the alias field of the certificate subject.</p> <p>Example: Printer's IP address : 192.0.2.123, Printer name : EPSONA1B2C3 Common Name : EPSONA1B2C3,EPSONA1B2C3.local,192.0.2.123</p>
Organization/ Organizational Unit/ Locality/ State/Province	You can enter between 0 and 64 characters in ASCII (0x20-0x7E). You can divide distinguished names with commas.
Country	Enter a country code in two-digit number specified by ISO-3166.
Sender's Email Address	You can enter the sender's email address for the mail server setting. Enter the same email address as the Sender's Email Address for the Network tab > Email Server > Basic .

Related Information

➔ [“Obtaining a CA-signed Certificate” on page 244](#)

Importing a CA-signed Certificate

Import the obtained CA-signed Certificate to the printer.



Important:

- Make sure that the printer's date and time is set correctly. Certificate may be invalid.
- If you obtain a certificate using a CSR created from Web Config, you can import a certificate one time.

1. Enter the printer's IP address into a browser to access Web Config.
 Enter the printer's IP address from a computer that is connected to the same network as the printer.
 You can check the IP address of the printer from the following menu.
Settings > General Settings > Network Settings > Network Status > Wired LAN/Wi-Fi Status
2. Enter the administrator password to log in as an administrator.
3. Select in the following order.
Network Security tab. > **SSL/TLS > Certificate**, or **IPsec/IP Filtering > Client Certificate** or **IEEE802.1X**
4. Click **Import**
 A certificate importing page is opened.

- Enter a value for each item. Set **CA Certificate 1** and **CA Certificate 2** when verifying the path of the certificate on the web browser that accesses the printer.

Depending on where you create a CSR and the file format of the certificate, required settings may vary. Enter values to required items according to the following.

- A certificate of the PEM/DER format obtained from Web Config
 - Private Key:** Do not configure because the printer contains a private key.
 - Password:** Do not configure.
 - CA Certificate 1/CA Certificate 2:** Optional
- A certificate of the PEM/DER format obtained from a computer
 - Private Key:** You need to set.
 - Password:** Do not configure.
 - CA Certificate 1/CA Certificate 2:** Optional
- A certificate of the PKCS#12 format obtained from a computer
 - Private Key:** Do not configure.
 - Password:** Optional
 - CA Certificate 1/CA Certificate 2:** Do not configure.

- Click **OK**.

A completion message is displayed.

Note:

Click **Confirm** to verify the certificate information.

Related Information

- ➔ [“Default Value of the Administrator Password” on page 16](#)
- ➔ [“Deleting a CA-signed Certificate” on page 248](#)

CA-signed Certificate Importing Setting Items

Items	Settings and Explanation
Server Certificate or Client Certificate	Select a certificate's format. For SSL/TLS connection, the Server Certificate is displayed. For IPsec/IP Filtering or IEEE802.1x, the Client Certificate is displayed.
Private Key	If you obtain a certificate of the PEM/DER format by using a CSR created from a computer, specify a private key file that is match a certificate.
Password	If the file format is Certificate with Private Key (PKCS#12) , enter the password for encrypting the private key that is set when you obtain the certificate.
CA Certificate 1	If your certificate's format is Certificate (PEM/DER) , import a certificate of a certificate authority that issues a CA-signed Certificate used as server certificate. Specify a file if you need.
CA Certificate 2	If your certificate's format is Certificate (PEM/DER) , import a certificate of a certificate authority that issues CA Certificate 1. Specify a file if you need.

Related Information

➔ [“Importing a CA-signed Certificate” on page 246](#)

Deleting a CA-signed Certificate

You can delete an imported certificate when the certificate has expired or when an encrypted connection is no longer necessary.



Important:

If you obtain a certificate using a CSR created from Web Config, you cannot import a deleted certificate again. In this case, create a CSR and obtain a certificate again.

1. Enter the printer's IP address into a browser to access Web Config.
Enter the printer's IP address from a computer that is connected to the same network as the printer.
You can check the IP address of the printer from the following menu.
Settings > General Settings > Network Settings > Network Status > Wired LAN/Wi-Fi Status
2. Enter the administrator password to log in as an administrator.
3. Select in the following order.
Network Security tab.
4. Select one of the following.
 - SSL/TLS > Certificate**
 - IPsec/IP Filtering > Client Certificate**
 - IEEE802.1X > Client Certificate**
5. Click **Delete**.
6. Confirm that you want to delete the certificate in the message displayed.

Related Information

➔ [“Default Value of the Administrator Password” on page 16](#)

Updating a Self-signed Certificate

Because the Self-signed Certificate is issued by the printer, you can update it when it has expired or when the content described changes.

1. Enter the printer's IP address into a browser to access Web Config.
Enter the printer's IP address from a computer that is connected to the same network as the printer.
You can check the IP address of the printer from the following menu.
Settings > General Settings > Network Settings > Network Status > Wired LAN/Wi-Fi Status
2. Enter the administrator password to log in as an administrator.

3. Select in the following order.

Network Security tab > **SSL/TLS** > **Certificate**

4. Click **Update**.

5. Enter **Common Name**.

You can enter up to 5 IPv4 addresses, IPv6 addresses, host names, FQDNs between 1 to 128 characters and separating them with commas. The first parameter is stored to the common name, and the others are stored to the alias field for the subject of the certificate.

Example:

Printer's IP address : 192.0.2.123, Printer name : EPSONA1B2C3

Common name : EPSONA1B2C3,EPSONA1B2C3.local,192.0.2.123

6. Specify a validity period for the certificate.

7. Click **Next**.

A confirmation message is displayed.

8. Click **OK**.

The printer is updated.

Note:

You can check the certificate information from **Network Security** tab > **SSL/TLS** > **Certificate** > **Self-signed Certificate** and click **Confirm**.

Related Information

➔ [“Default Value of the Administrator Password” on page 16](#)

Configuring a CA Certificate

When you set the CA Certificate, you can validate the path to the CA certificate of the server that the printer accesses. This can prevent impersonation.

You can obtain the CA Certificate from the Certification Authority where the CA-signed Certificate is issued.

Importing a CA Certificate

Import the CA Certificate to the printer.

1. Enter the printer's IP address into a browser to access Web Config.

Enter the printer's IP address from a computer that is connected to the same network as the printer.

You can check the IP address of the printer from the following menu.

Settings > **General Settings** > **Network Settings** > **Network Status** > **Wired LAN/Wi-Fi Status**

2. Enter the administrator password to log in as an administrator.

3. Select in the following order.

Network Security tab > **CA Certificate**

4. Click **Import**.
5. Specify the CA Certificate you want to import.
6. Click **OK**.

When importing is complete, you are returned to the **CA Certificate** screen, and the imported CA Certificate is displayed.

Related Information

➔ [“Default Value of the Administrator Password” on page 16](#)

Deleting a CA Certificate

You can delete the imported CA Certificate.

1. Enter the printer's IP address into a browser to access Web Config.
Enter the printer's IP address from a computer that is connected to the same network as the printer.
You can check the IP address of the printer from the following menu.
Settings > General Settings > Network Settings > Network Status > Wired LAN/Wi-Fi Status
2. Enter the administrator password to log in as an administrator.
3. Select in the following order.
Network Security tab > CA Certificate
4. Click **Delete** next to the CA Certificate that you want to delete.
5. Confirm that you want to delete the certificate in the message displayed.
6. Click **Reboot Network**, and then check that the deleted CA Certificate is not listed on the updated screen.

Related Information

➔ [“Default Value of the Administrator Password” on page 16](#)

SSL/TLS Communication with the Printer

When the server certificate is set using SSL/TLS (Secure Sockets Layer/Transport Layer Security) communication to the printer, you can encrypt the communication path between computers. Do this if you want to prevent remote and unauthorized access.

Configuring Basic SSL/TLS Settings

If the printer supports the HTTPS server feature, you can use an SSL/TLS communication to encrypt communications. You can configure and manage the printer using Web Config while ensuring security.

Configure encryption strength and redirect feature.

1. Enter the printer's IP address into a browser to access Web Config.
Enter the printer's IP address from a computer that is connected to the same network as the printer.
You can check the IP address of the printer from the following menu.
Settings > General Settings > Network Settings > Network Status > Wired LAN/Wi-Fi Status
2. Enter the administrator password to log in as an administrator.
3. Select in the following order.
Network Security tab > **SSL/TLS** > **Basic**
4. Select a value for each item.
 - Encryption Strength
Select the level of encryption strength.
 - Redirect HTTP to HTTPS
Select enable or disable. The default value is "Enable".
 - TLS 1.0
Select enable or disable. The default value is "Disable".
 - TLS.1.1
Select enable or disable. The default value is "Disable".
 - TLS.1.2
Select enable or disable. The default value is "Enable".
5. Click **Next**.
A confirmation message is displayed.
6. Click **OK**.
The printer is updated.

Related Information

➔ [“Default Value of the Administrator Password” on page 16](#)

Configuring a Server Certificate for the Printer

1. Enter the printer's IP address into a browser to access Web Config.
Enter the printer's IP address from a computer that is connected to the same network as the printer.
You can check the IP address of the printer from the following menu.
Settings > General Settings > Network Settings > Network Status > Wired LAN/Wi-Fi Status
2. Enter the administrator password to log in as an administrator.
3. Select in the following order.
Network Security tab > **SSL/TLS** > **Certificate**

4. Specify a certificate to use on **Server Certificate**.

Self-signed Certificate

A self-signed certificate has been generated by the printer. If you do not obtain a CA-signed certificate, select this.

CA-signed Certificate

If you obtain and import a CA-signed certificate in advance, you can specify this.

5. Click **Next**.

A confirmation message is displayed.

6. Click **OK**.

The printer is updated.

Related Information

➔ [“Default Value of the Administrator Password” on page 16](#)

➔ [“Configuring a CA-signed Certificate” on page 244](#)

➔ [“Updating a Self-signed Certificate” on page 248](#)

Encrypted Communication Using IPsec/IP Filtering

About IPsec/IP Filtering

You can filter traffic based on IP addresses, services, and port by using IPsec/IP Filtering function. By combining of the filtering, you can configure the printer to accept or block specified clients and specified data. Additionally, you can improve security level by using an IPsec.

Note:

Computers that run Windows Vista or later or Windows Server 2008 or later support IPsec.

Configuring Default Policy

To filter traffic, configure the default policy. The default policy applies to every user or group connecting to the printer. For more fine-grained control over users and groups of users, configure group policies.

1. Enter the printer's IP address into a browser to access Web Config.

Enter the printer's IP address from a computer that is connected to the same network as the printer.

You can check the IP address of the printer from the following menu.

Settings > General Settings > Network Settings > Network Status > Wired LAN/Wi-Fi Status

2. Enter the administrator password to log in as an administrator.

3. Select in the following order.

Network Security tab > IPsec/IP Filtering > Basic

4. Enter a value for each item.

5. Click **Next**.

A confirmation message is displayed.

6. Click **OK**.

The printer is updated.

Default Policy Setting Items

Default Policy

Items	Settings and Explanation
IPsec/IP Filtering	You can enable or disable an IPsec/IP Filtering feature.

Access Control

Configure a control method for traffic of IP packets.

Items	Settings and Explanation
Permit Access	Select this to permit configured IP packets to pass through.
Refuse Access	Select this to refuse configured IP packets to pass through.
IPsec	Select this to permit configured IPsec packets to pass through.

IKE Version

Select **IKEv1** or **IKEv2** for **IKE Version**. Select one of them according to the device that the printer is connected to.

IKEv1

The following items are displayed when you select **IKEv1** for **IKE Version**.

Items	Settings and Explanation
Authentication Method	To select Certificate , you need to obtain and import a CA-signed certificate in advance.
Pre-Shared Key	If you select Pre-Shared Key for Authentication Method , enter a pre-shared key between 1 and 127 characters.
Confirm Pre-Shared Key	Enter the key you configured for confirmation.

IKEv2

The following items are displayed when you select **IKEv2** for **IKE Version**.

Items	Settings and Explanation	
Local	Authentication Method	To select Certificate , you need to obtain and import a CA-signed certificate in advance.
	ID Type	If you select Pre-Shared Key for Authentication Method , select the type of ID for the printer.
	ID	Enter the printer's ID that matches the type of ID. You cannot use "@", "#", and "=" for the first character. Distinguished Name : Enter 1 to 255 1-byte ASCII (0x20 to 0x7E) characters. You need to include "=". IP Address : Enter IPv4 or IPv6 format. FQDN : Enter a combination of between 1 and 255 characters using A-Z, a-z, 0-9, "-", and period (.). Email Address : Enter 1 to 255 1-byte ASCII (0x20 to 0x7E) characters. You need to include "@". Key ID : Enter 1 to 255 1-byte ASCII (0x20 to 0x7E) characters.
	Pre-Shared Key	If you select Pre-Shared Key for Authentication Method , enter a pre-shared key between 1 and 127 characters.
	Confirm Pre-Shared Key	Enter the key you configured for confirmation.

Items		Settings and Explanation
Remote	Authentication Method	To select Certificate , you need to obtain and import a CA-signed certificate in advance.
	ID Type	If you select Pre-Shared Key for Authentication Method , select the type of ID for the device that you want to authenticate.
	ID	Enter the printer's ID that matches to the type of ID. You cannot use "@", "#", and "=" for the first character. Distinguished Name : Enter 1 to 255 1-byte ASCII (0x20 to 0x7E) characters. You need to include "=". IP Address : Enter IPv4 or IPv6 format. FQDN : Enter a combination of between 1 and 255 characters using A-Z, a-z, 0-9, "-", and period (.). Email Address : Enter 1 to 255 1-byte ASCII (0x20 to 0x7E) characters. You need to include "@". Key ID : Enter 1 to 255 1-byte ASCII (0x20 to 0x7E) characters.
	Pre-Shared Key	If you select Pre-Shared Key for Authentication Method , enter a pre-shared key between 1 and 127 characters.
	Confirm Pre-Shared Key	Enter the key you configured for confirmation.

Encapsulation

If you select **IPsec** for **Access Control**, you need to configure an encapsulation mode.

Items	Settings and Explanation
Transport Mode	If you only use the printer on the same LAN, select this. IP packets of layer 4 or later are encrypted.
Tunnel Mode	If you use the printer on the Internet-capable network such as IPsec-VPN, select this option. The header and data of the IP packets are encrypted. Remote Gateway(Tunnel Mode) : If you select Tunnel Mode for Encapsulation , enter a gateway address between 1 and 39 characters.

Security Protocol

If you select **IPsec** for **Access Control**, select an option.

Items	Settings and Explanation
ESP	Select this to ensure the integrity of an authentication and data, and encrypt data.
AH	Select this to ensure the integrity of an authentication and data. Even if encrypting data is prohibited, you can use IPsec.

Algorithm Settings

It is recommended that you select **Any** for all settings or select an item other than **Any** for each setting. If you select **Any** for some of the settings and select an item other than **Any** for the other settings, the device may not communicate depending on the other device that you want to authenticate.

Items		Settings and Explanation
IKE	Encryption	Select the encryption algorithm for IKE. The items vary depending on the version of IKE.
	Authentication	Select the authentication algorithm for IKE.
	Key Exchange	Select the key exchange algorithm for IKE. The items vary depending on the version of IKE.
ESP	Encryption	Select the encryption algorithm for ESP. This is available when ESP is selected for Security Protocol .
	Authentication	Select the authentication algorithm for ESP. This is available when ESP is selected for Security Protocol .
AH	Authentication	Select the encryption algorithm for AH. This is available when AH is selected for Security Protocol .

Related Information

➔ [“Default Value of the Administrator Password” on page 16](#)

Configuring Group Policy

A group policy is one or more rules applied to a user or user group. The printer controls IP packets that match with configured policies. IP packets are authenticated in the order of a group policy 1 to 10 then a default policy.

1. Enter the printer's IP address into a browser to access Web Config.
Enter the printer's IP address from a computer that is connected to the same network as the printer.
You can check the IP address of the printer from the following menu.
Settings > General Settings > Network Settings > Network Status > Wired LAN/Wi-Fi Status
2. Enter the administrator password to log in as an administrator.
3. Select in the following order.
Network Security tab > IPsec/IP Filtering > Basic
4. Click a numbered tab you want to configure.
5. Enter a value for each item.
6. Click **Next**.
A confirmation message is displayed.

7. Click **OK**.

The printer is updated.

Related Information

➔ [“Default Value of the Administrator Password” on page 16](#)

Group Policy Setting Items

Items	Settings and Explanation
Enable this Group Policy	You can enable or disable a group policy.

Access Control

Configure a control method for traffic of IP packets.

Items	Settings and Explanation
Permit Access	Select this to permit configured IP packets to pass through.
Refuse Access	Select this to refuse configured IP packets to pass through.
IPsec	Select this to permit configured IPsec packets to pass through.

Local Address(Printer)

Select an IPv4 address or IPv6 address that matches your network environment. If an IP address is assigned automatically, you can select **Use auto-obtained IPv4 address**.

Note:

If an IPv6 address is assigned automatically, the connection may be unavailable. Configure a static IPv6 address.

Remote Address(Host)

Enter a device's IP address to control access. The IP address must be 43 characters or less. If you do not enter an IP address, all addresses are controlled.

Note:

If an IP address is assigned automatically (e.g. assigned by DHCP), the connection may be unavailable. Configure a static IP address.

Method of Choosing Port

Select a method to specify ports.

Service Name

If you select **Service Name** for **Method of Choosing Port**, select an option.

Transport Protocol

If you select **Port Number** for **Method of Choosing Port**, you need to configure an encapsulation mode.

Items	Settings and Explanation
Any Protocol	Select this to control all protocol types.
TCP	Select this to control data for unicast.
UDP	Select this to control data for broadcast and multicast.
ICMPv4	Select this to control ping command.

Local Port

If you select **Port Number** for **Method of Choosing Port** and if you select **TCP** or **UDP** for **Transport Protocol**, enter port numbers to control receiving packets, separating them with commas. You can enter 10 port numbers at the maximum.

Example: 20,80,119,5220

If you do not enter a port number, all ports are controlled.

Remote Port

If you select **Port Number** for **Method of Choosing Port** and if you select **TCP** or **UDP** for **Transport Protocol**, enter port numbers to control sending packets, separating them with commas. You can enter 10 port numbers at the maximum.

Example: 25,80,143,5220

If you do not enter a port number, all ports are controlled.

IKE Version

Select **IKEv1** or **IKEv2** for **IKE Version**. Select one of them according to the device that the printer is connected to.

IKEv1

The following items are displayed when you select **IKEv1** for **IKE Version**.

Items	Settings and Explanation
Authentication Method	If you select IPsec for Access Control , select an option. Used certificate is common with a default policy.
Pre-Shared Key	If you select Pre-Shared Key for Authentication Method , enter a pre-shared key between 1 and 127 characters.
Confirm Pre-Shared Key	Enter the key you configured for confirmation.

❑ IKEv2

The following items are displayed when you select **IKEv2** for **IKE Version**.

Items		Settings and Explanation
Local	Authentication Method	If you select IPsec for Access Control , select an option. Used certificate is common with a default policy.
	ID Type	If you select Pre-Shared Key for Authentication Method , select the type of ID for the printer.
	ID	Enter the printer's ID that matches the type of ID. You cannot use "@", "#", and "=" for the first character. Distinguished Name : Enter 1 to 255 1-byte ASCII (0x20 to 0x7E) characters. You need to include "=". IP Address : Enter IPv4 or IPv6 format. FQDN : Enter a combination of between 1 and 255 characters using A-Z, a-z, 0-9, "-", and period (.). Email Address : Enter 1 to 255 1-byte ASCII (0x20 to 0x7E) characters. You need to include "@". Key ID : Enter 1 to 255 1-byte ASCII (0x20 to 0x7E) characters.
	Pre-Shared Key	If you select Pre-Shared Key for Authentication Method , enter a pre-shared key between 1 and 127 characters.
	Confirm Pre-Shared Key	Enter the key you configured for confirmation.
Remote	Authentication Method	If you select IPsec for Access Control , select an option. Used certificate is common with a default policy.
	ID Type	If you select Pre-Shared Key for Authentication Method , select the type of ID for the device that you want to authenticate.
	ID	Enter the printer's ID that matches to the type of ID. You cannot use "@", "#", and "=" for the first character. Distinguished Name : Enter 1 to 255 1-byte ASCII (0x20 to 0x7E) characters. You need to include "=". IP Address : Enter IPv4 or IPv6 format. FQDN : Enter a combination of between 1 and 255 characters using A-Z, a-z, 0-9, "-", and period (.). Email Address : Enter 1 to 255 1-byte ASCII (0x20 to 0x7E) characters. You need to include "@". Key ID : Enter 1 to 255 1-byte ASCII (0x20 to 0x7E) characters.
	Pre-Shared Key	If you select Pre-Shared Key for Authentication Method , enter a pre-shared key between 1 and 127 characters.
	Confirm Pre-Shared Key	Enter the key you configured for confirmation.

Encapsulation

If you select **IPsec** for **Access Control**, you need to configure an encapsulation mode.

Items	Settings and Explanation
Transport Mode	If you only use the printer on the same LAN, select this. IP packets of layer 4 or later are encrypted.
Tunnel Mode	If you use the printer on the Internet-capable network such as IPsec-VPN, select this option. The header and data of the IP packets are encrypted. Remote Gateway(Tunnel Mode): If you select Tunnel Mode for Encapsulation , enter a gateway address between 1 and 39 characters.

Security Protocol

If you select **IPsec** for **Access Control**, select an option.

Items	Settings and Explanation
ESP	Select this to ensure the integrity of an authentication and data, and encrypt data.
AH	Select this to ensure the integrity of an authentication and data. Even if encrypting data is prohibited, you can use IPsec.

Algorithm Settings

It is recommended that you select **Any** for all settings or select an item other than **Any** for each setting. If you select **Any** for some of the settings and select an item other than **Any** for the other settings, the device may not communicate depending on the other device that you want to authenticate.

Items	Settings and Explanation
IKE	Encryption Select the encryption algorithm for IKE. The items vary depending on the version of IKE.
	Authentication Select the authentication algorithm for IKE.
	Key Exchange Select the key exchange algorithm for IKE. The items vary depending on the version of IKE.
ESP	Encryption Select the encryption algorithm for ESP. This is available when ESP is selected for Security Protocol .
	Authentication Select the authentication algorithm for ESP. This is available when ESP is selected for Security Protocol .
AH	Authentication Select the encryption algorithm for AH. This is available when AH is selected for Security Protocol .

Combination of Local Address(Printer) and Remote Address(Host) on Group Policy

	Setting of Local Address(Printer)		
		IPv4	IPv6* ²

Setting of Remote Address(Host)	IPv4*1	✓	–	✓
	IPv6*1*2	–	✓	✓
	Blank	✓	✓	✓

*1 : If **IPsec** is selected for **Access Control**, you cannot specify in a prefix length.

*2 : If **IPsec** is selected for **Access Control**, you can select a link-local address (fe80::) but group policy will be disabled.

*3 : Except IPv6 link local addresses.

References of Service Name on Group Policy

Note:

Unavailable services are displayed but cannot be selected.

Service Name	Protocol type	Local port number	Remote port number	Features controlled
Any	–	–	–	All services
ENPC	UDP	3289	Any port	Searching for a printer from applications such as Epson Device Admin, and the printer driver
SNMP	UDP	161	Any port	Acquiring and configuring of MIB from applications such as Epson Device Admin, and the printer driver
LPR	TCP	515	Any port	Forwarding LPR data
RAW (Port9100)	TCP	9100	Any port	Forwarding RAW data
IPP/IPPS	TCP	631	Any port	Forwarding data of IPP/IPPS printing
WSD	TCP	Any port	5357	Controlling WSD
WS-Discovery	UDP	3702	Any port	Searching for a printer from WSD
FTP Data (Local)	TCP	20	Any port	FTP server (forwarding data of FTP printing)
FTP Control (Local)	TCP	21	Any port	FTP server (controlling FTP printing)
HTTP (Local)	TCP	80	Any port	HTTP(S) server (forwarding data of Web Config and WSD)
HTTPS (Local)	TCP	443	Any port	
HTTP (Remote)	TCP	Any port	80	HTTP(S) client (communicating between Epson Connect, firmware updating and root certificate updating)
HTTPS (Remote)	TCP	Any port	443	

Configuration Examples of IPsec/IP Filtering

Receiving IPsec packets only

This example is to configure a default policy only.

Default Policy:

- IPsec/IP Filtering: Enable**
- Access Control: IPsec**
- Authentication Method: Pre-Shared Key**
- Pre-Shared Key:** Enter up to 127 characters.

Group Policy: Do not configure.

Receiving printing data and printer settings

This example allows communications of printing data and printer configuration from specified services.

Default Policy:

- IPsec/IP Filtering: Enable**
- Access Control: Refuse Access**

Group Policy:

- Enable this Group Policy:** Check the box.
- Access Control: Permit Access**
- Remote Address(Host):** IP address of a client
- Method of Choosing Port: Service Name**
- Service Name:** Check the box of ENPC, SNMP, HTTP (Local), HTTPS (Local) and RAW (Port9100).

Note:

To avoid receiving HTTP (Local) and HTTPS (Local), clear their checkboxes in **Group Policy**. When doing so, disable IPsec/IP filtering from the printer's control panel temporarily to change the printer settings.

Receiving access from a specified IP address only

This example allows a specified IP address to access the printer.

Default Policy:

- IPsec/IP Filtering: Enable**
- Access Control: Refuse Access**

Group Policy:

- Enable this Group Policy:** Check the box.
- Access Control: Permit Access**
- Remote Address(Host):** IP address of an administrator's client

Note:

Regardless of policy configuration, the client will be able to access and configure the printer.

Configuring a Certificate for IPsec/IP Filtering

Configure the Client Certificate for IPsec/IP Filtering. When you set it, you can use the certificate as an authentication method for IPsec/IP Filtering. If you want to configure the certification authority, go to **CA Certificate**.

1. Enter the printer's IP address into a browser to access Web Config.
Enter the printer's IP address from a computer that is connected to the same network as the printer.
You can check the IP address of the printer from the following menu.
Settings > General Settings > Network Settings > Network Status > Wired LAN/Wi-Fi Status
2. Enter the administrator password to log in as an administrator.
3. Select in the following order.
Network Security tab > IPsec/IP Filtering > Client Certificate
4. Import the certificate in **Client Certificate**.
If you have already imported a certificate published by a Certification Authority, you can copy the certificate and use it in IPsec/IP Filtering. To copy, select the certificate from **Copy From**, and then click **Copy**.

Related Information

- ➔ [“Default Value of the Administrator Password” on page 16](#)
- ➔ [“Configuring a CA-signed Certificate” on page 244](#)
- ➔ [“Configuring a CA Certificate” on page 249](#)

Connecting the Printer to an IEEE802.1X Network

Configuring an IEEE802.1X Network

When you set IEEE802.1X to the printer, you can use it on the network connected to a RADIUS server, a LAN switch with authentication function, or an access point.

TLS version 1.3 does not support this function.

1. Enter the printer's IP address into a browser to access Web Config.
Enter the printer's IP address from a computer that is connected to the same network as the printer.
You can check the IP address of the printer from the following menu.
Settings > General Settings > Network Settings > Network Status > Wired LAN/Wi-Fi Status
2. Enter the administrator password to log in as an administrator.
3. Select in the following order.
Network Security tab > IEEE802.1X > Basic
4. Enter a value for each item.
If you want to use the printer on a Wi-Fi network, click **Wi-Fi Setup** and select or enter an SSID.

Note:

You can share settings between Ethernet and Wi-Fi.

5. Click **Next**.

A confirmation message is displayed.

6. Click **OK**.

The printer is updated.

Related Information

➔ [“Default Value of the Administrator Password” on page 16](#)

IEEE802.1X Network Setting Items

Items	Settings and Explanation	
IEEE802.1X (Wired LAN)	You can enable or disable settings of the page (IEEE802.1X > Basic) for IEEE802.1X (Wired LAN).	
IEEE802.1X (Wi-Fi)	The connection status of IEEE802.1X (Wi-Fi) is displayed.	
Connection Method	The connection method of a current network is displayed.	
EAP Type	Select an option for an authentication method between the printer and a RADIUS server.	
	EAP-TLS	You need to obtain and import a CA-signed certificate.
	PEAP-TLS	
	EAP-TTLS	You need to configure a password.
PEAP/MSCHAPv2		
User ID	Configure an ID to use for an authentication of a RADIUS server. Enter 1 to 128 1-byte ASCII (0x20 to 0x7E) characters.	
Password	Configure a password to authenticate the printer. Enter 1 to 128 1-byte ASCII (0x20 to 0x7E) characters. If you are using a Windows server as a RADIUS server, you can enter up to 127 characters.	
Confirm Password	Enter the password you configured for confirmation.	
Server ID	You can configure a server ID to authenticate with a specified RADIUS server. Authenticator verifies whether a server ID is contained in the subject/subjectAltName field of a server certificate that is sent from a RADIUS server or not. Enter 0 to 128 1-byte ASCII (0x20 to 0x7E) characters.	
Certificate Validation (Wired LAN Only)	You can set certificate validation regardless of the authentication method. Import the certificate in CA Certificate . This item only supports wired LAN connections. A CA Certificate is required to connect to a Wi-Fi network with IEEE802.1X.	
Anonymous Name	If you select PEAP-TLS , EAP-TTLS or PEAP/MSCHAPv2 for EAP Type , you can configure an anonymous name instead of a user ID for a phase 1 of a PEAP authentication. Enter 0 to 128 1-byte ASCII (0x20 to 0x7E) characters.	

Items	Settings and Explanation	
Encryption Strength	You can select one of the followings.	
	High	AES256/3DES
	Middle	AES256/3DES/AES128/RC4

Related Information

➔ [“Configuring an IEEE802.1X Network” on page 263](#)

Configuring a Certificate for IEEE802.1X

Configure the Client Certificate for IEEE802.1X. When you set it, you can use **EAP-TLS** and **PEAP-TLS** as an authentication method of IEEE802.1x. If you want to configure the certification authority certificate, go to **CA Certificate**.

1. Enter the printer's IP address into a browser to access Web Config.
Enter the printer's IP address from a computer that is connected to the same network as the printer.
You can check the IP address of the printer from the following menu.
Settings > General Settings > Network Settings > Network Status > Wired LAN/Wi-Fi Status
2. Enter the administrator password to log in as an administrator.
3. Select in the following order.
Network Security tab > IEEE802.1X > Client Certificate
4. Enter a certificate in the **Client Certificate**.
If you have already imported a certificate published by a Certification Authority, you can copy the certificate and use it in IEEE802.1X. To copy, select the certificate from **Copy From**, and then click **Copy**.

Related Information

- ➔ [“Default Value of the Administrator Password” on page 16](#)
- ➔ [“Configuring a CA-signed Certificate” on page 244](#)
- ➔ [“Configuring a CA Certificate” on page 249](#)

Checking IEEE802.1X Network Status

You can check the IEEE802.1X status by printing a network status sheet.

Status ID	IEEE802.1X Status
Disable	IEEE802.1X feature is disable.
EAP Success	IEEE802.1X authentication has succeeded and network connection is available.
Authenticating	IEEE802.1X authentication has not been completed.
Config Error	Authentication has failed since the user ID has not been set.

Status ID	IEEE802.1X Status
Client Certificate Error	Authentication has failed since the client certificate is out of date.
Timeout Error	Authentication has failed since there is no answer from the RADIUS server and/or authenticator.
User ID Error	Authentication has failed since the printer's user ID and/or certificate protocol is incorrect.
Server ID Error	Authentication has failed since the server ID of the server certificate and the server's ID do not match.
Server Certificate Error	Authentication has failed since there are the following errors in the server certificate. <ul style="list-style-type: none"> <input type="checkbox"/> The server certificate is out of date. <input type="checkbox"/> The chain of the server certificate is incorrect.
CA Certificate Error	Authentication has failed since there are the following errors in a CA certificate. <ul style="list-style-type: none"> <input type="checkbox"/> Specified CA certificate is incorrect. <input type="checkbox"/> The correct CA certificate is not imported. <input type="checkbox"/> CA certificate is out of date.
EAP Failure	Authentication has failed since there are the following errors in the printer settings. <ul style="list-style-type: none"> <input type="checkbox"/> If EAP Type is EAP-TLS or PEAP-TLS, client certificate is incorrect or has certain problems. <input type="checkbox"/> If EAP Type is EAP-TTLS or PEAP/MSCHAPv2, user ID or password is not correct.

Related Information

➔ [“Wired LAN/Wi-Fi Status:” on page 192](#)

Network Security Issues

Restoring the Security Settings

When you establish a highly secure environment such as IPsec/IP Filtering or IEEE802.1X, you may not be able to communicate with devices because of incorrect settings or trouble with the device or server. In this case, restore the security settings in order to make settings for the device again or to allow you temporary use.

Disabling the Security Function Using the Control Panel

You can disable IPsec/IP Filtering or IEEE802.1X using the printer's control panel.

1. Select **Settings > General Settings > Network Settings**.
2. Select **Advanced**.

3. Select from the following items that you want to disable.

- Disable IPsec/IP Filtering**
- Disable IEEE802.1X**

4. Select **Proceed** on the confirmation screen.

Problems Using Network Security Features

Forgot a Pre-shared Key

Re-configure a pre-shared key.

To change the key, access Web Config and select the **Network Security** tab > **IPsec/IP Filtering** > **Basic** > **Default Policy** or **Group Policy**.

When you change the pre-shared key, configure the pre-shared key for computers.

Related Information

- ➔ [“Default Value of the Administrator Password” on page 16](#)
- ➔ [“Encrypted Communication Using IPsec/IP Filtering” on page 252](#)

Cannot Communicate with IPsec Communication

Specify the algorithm that the printer or the computer does not support.

The printer supports the following algorithms. Check the settings of the computer.

Security Methods	Algorithms
IKE encryption algorithm	AES-CBC-128, AES-CBC-192, AES-CBC-256, AES-GCM-128*, AES-GCM-192*, AES-GCM-256*, 3DES
IKE authentication algorithm	SHA-1, SHA-256, SHA-384, SHA-512, MD5
IKE key exchange algorithm	DH Group1, DH Group2, DH Group5, DH Group14, DH Group15, DH Group16, DH Group17, DH Group18, DH Group19, DH Group20, DH Group21, DH Group22, DH Group23, DH Group24, DH Group25, DH Group26, DH Group27*, DH Group28*, DH Group29*, DH Group30*
ESP encryption algorithm	AES-CBC-128, AES-CBC-192, AES-CBC-256, AES-GCM-128, AES-GCM-192, AES-GCM-256, 3DES
ESP authentication algorithm	SHA-1, SHA-256, SHA-384, SHA-512, MD5
AH authentication algorithm	SHA-1, SHA-256, SHA-384, SHA-512, MD5

*available for IKEv2 only

Related Information

- ➔ [“Encrypted Communication Using IPsec/IP Filtering” on page 252](#)

Cannot Communicate Suddenly

The IP address of the printer has been changed or cannot be used.

When the IP address registered to the local address on Group Policy has been changed or cannot be used, IPsec communication cannot be performed. Disable IPsec using the printer's control panel.

If the DHCP is out of date, rebooting or the IPv6 address is out of date or has not been obtained, then the IP address registered for the printer's Web Config (**Network Security** tab > **IPsec/IP Filtering** > **Basic** > **Group Policy** > **Local Address(Printer)**) may not be found.

Use a static IP address.

The IP address of the computer has been changed or cannot be used.

When the IP address registered to the remote address on Group Policy has been changed or cannot be used, IPsec communication cannot be performed.

Disable IPsec using the printer's control panel.

If the DHCP is out of date, rebooting or the IPv6 address is out of date or has not been obtained, then the IP address registered for the printer's Web Config (**Network Security** tab > **IPsec/IP Filtering** > **Basic** > **Group Policy** > **Remote Address(Host)**) may not be found.

Use a static IP address.

Related Information

- ➔ [“Default Value of the Administrator Password” on page 16](#)
- ➔ [“Encrypted Communication Using IPsec/IP Filtering” on page 252](#)

Cannot Create the Secure IPP Printing Port

The correct certificate is not specified as the server certificate for SSL/TLS communication.

If the specified certificate is not correct, creating a port may fail. Make sure you are using the correct certificate.

The CA certificate is not imported to the computer accessing the printer.

If a CA certificate is not imported to the computer, creating a port may fail. Make sure a CA certificate is imported.

Related Information

- ➔ [“Configuring a Server Certificate for the Printer” on page 251](#)

Cannot Connect After Configuring IPsec/IP Filtering

The settings of IPsec/IP Filtering are incorrect.

Disable IPsec/IP filtering from the printer's control panel. Connect the printer and computer and make the IPsec/IP Filtering settings again.

Related Information

- ➔ [“Encrypted Communication Using IPsec/IP Filtering” on page 252](#)

Cannot Access the Printer after Configuring IEEE802.1X

The settings of IEEE802.1X are incorrect.

Disable IEEE802.1X and Wi-Fi from the printer's control panel. Connect the printer and a computer, and then configure IEEE802.1X again.

Related Information

➔ [“Configuring an IEEE802.1X Network” on page 263](#)

Problems on Using a Digital Certificate

Cannot Import a CA-signed Certificate

CA-signed Certificate and the information on the CSR do not match.

If the CA-signed Certificate and CSR do not have the same information, the CSR cannot be imported. Check the following:

- Are you trying to import the certificate to a device that does not have the same information?
Check the information of the CSR and then import the certificate to a device that has the same information.
- Did you overwrite the CSR saved into the printer after sending the CSR to a certificate authority?
Obtain the CA-signed certificate again with the CSR.

CA-signed Certificate is more than 5KB.

You cannot import a CA-signed Certificate that is more than 5KB.

The password for importing the certificate is incorrect.

Enter the correct password. If you forget the password, you cannot import the certificate. Re-obtain the CA-signed Certificate.

Related Information

➔ [“Importing a CA-signed Certificate” on page 246](#)

Cannot Update a Self-Signed Certificate

The Common Name has not been entered.

Common Name must be entered.

Unsupported characters have been entered to Common Name.

Enter between 1 and 128 characters of either IPv4, IPv6, host name, or FQDN format in ASCII (0x20-0x7E).

A comma or space is included in the common name.

If a comma is entered, the **Common Name** is divided at that point. If only a space is entered before or after a comma, an error occurs.

Related Information

➔ [“Updating a Self-signed Certificate” on page 248](#)

Cannot Create a CSR

The Common Name has not been entered.

The **Common Name** must be entered.

Unsupported characters have been entered to Common Name, Organization, Organizational Unit, Locality, and State/Province.

Enter characters of either IPv4, IPv6, host name, or FQDN format in ASCII (0x20-0x7E).

A comma or space is included in the Common Name.

If a comma is entered, the **Common Name** is divided at that point. If only a space is entered before or after a comma, an error occurs.

Related Information

➔ [“Obtaining a CA-signed Certificate” on page 244](#)

Warning Relating to a Digital Certificate Appears

Messages	Cause/What to do
Enter a Server Certificate.	<p>Cause: You have not selected a file to import.</p> <p>What to do: Select a file and click Import.</p>
CA Certificate 1 is not entered.	<p>Cause: CA certificate 1 is not entered and only CA certificate 2 is entered.</p> <p>What to do: Import CA certificate 1 first.</p>
Invalid value below.	<p>Cause: Unsupported characters are contained in the file path and/or password.</p> <p>What to do: Make sure that the characters are entered correctly for the item.</p>
Invalid date and time.	<p>Cause: Date and time for the printer have not been set.</p> <p>What to do: Set date and time using Web Config, EpsonNet Config or the printer's control panel.</p>

Messages	Cause/What to do
Invalid password.	<p>Cause: The password set for CA certificate and entered password do not match.</p> <p>What to do: Enter the correct password.</p>
Invalid file.	<p>Cause: You are not importing a certificate file in X509 format.</p> <p>What to do: Make sure that you are selecting the correct certificate sent by a trusted certificate authority.</p>
	<p>Cause: The file you have imported is too large. The maximum file size is 5KB.</p> <p>What to do: If you select the correct file, the certificate might be corrupted or fabricated.</p>
	<p>Cause: The chain contained in the certificate is invalid.</p> <p>What to do: For more information on the certificate, see the website of the certificate authority.</p>
Cannot use the Server Certificates that include more than three CA certificates.	<p>Cause: The certificate file in PKCS#12 format contains more than 3 CA certificates.</p> <p>What to do: Import each certificate as converting from PKCS#12 format to PEM format, or import the certificate file in PKCS#12 format that contains up to 2 CA certificates.</p>
The certificate has expired. Check if the certificate is valid, or check the date and time on your printer.	<p>Cause: The certificate is out of date.</p> <p>What to do:</p> <ul style="list-style-type: none"> <input type="checkbox"/> If the certificate is out of date, obtain and import the new certificate. <input type="checkbox"/> If the certificate is not out of date, make sure the printer's date and time are set correctly.

Messages	Cause/What to do
Private key is required.	<p>Cause:</p> <p>There is no paired private key with the certificate.</p> <p>What to do:</p> <ul style="list-style-type: none"> <input type="checkbox"/> If the certificate is the PEM/DER format and it is obtained from a CSR using a computer, specify the private key file. <input type="checkbox"/> If the certificate is the PKCS#12 format and it is obtained from a CSR using a computer, create a file that contains the private key.
	<p>Cause:</p> <p>You have re-imported the PEM/DER certificate obtained from a CSR using Web Config.</p> <p>What to do:</p> <p>If the certificate is the PEM/DER format and it is obtained from a CSR using Web Config, you can only import it once.</p>
Setup failed.	<p>Cause:</p> <p>Cannot finish the configuration because the communication between the printer and computer failed or the file cannot be read by some errors.</p> <p>What to do:</p> <p>After checking the specified file and communication, import the file again.</p>

Related Information

➔ [“About Digital Certification” on page 244](#)

Delete a CA-signed Certificate by Mistake

There is no backup file for the CA-signed certificate.

If you have the backup file, import the certificate again.

If you obtain a certificate using a CSR created from Web Config, you cannot import a deleted certificate again. Create a CSR and obtain a new certificate.

Related Information

➔ [“Importing a CA-signed Certificate” on page 246](#)

➔ [“Deleting a CA-signed Certificate” on page 248](#)

Using Epson Open Platform

Epson Open Platform Overview

Epson Open Platform is a platform to use Epson printers with the function provided by the server of the authentication system.

You can acquire the logs of each device and user in cooperation with the server, and configure restrictions on the device and functions that can be used for each user and group. It can be used with Epson Print Admin (Epson Authentication System) or a third-party authentication system.

If you connect an authentication device, you can also perform user authentication using the ID card.

Related Information

➔ [“Epson Authentication System \(Epson Print Admin\)” on page 184](#)

Configuring Epson Open Platform

Enable Epson Open Platform so that you can use the device from the authentication system.

1. Enter the printer's IP address into a browser to access Web Config.
Enter the printer's IP address from a computer that is connected to the same network as the printer.
You can check the IP address of the printer from the following menu.
Settings > General Settings > Network Settings > Network Status > Wired LAN/Wi-Fi Status
2. Enter the administrator password to log in as an administrator.
3. Select in the following order.
Epson Open Platform tab > Product Key or License Key
4. Enter a value for each item.
 - Serial Number
The serial number of the device is displayed.
 - Epson Open Platform Version
Select the version of Epson Open Platform. The corresponding version varies depending on the authentication system.
 - Product Key or License Key
Enter the product key obtained from the dedicated Web site. See the Epson Open Platform manual for details such as how to obtain the product key.
5. Click **Next**.
A confirmation message is displayed.
6. Click **OK**.
The printer is updated.

Related Information

➔ [“Default Value of the Administrator Password” on page 16](#)

Validating of Epson Open Platform

You can check the validity of Epson Open Platform using any of the following methods.

Web Config

A product key has been entered in the **Epson Open Platform** tab > **Product Key or License Key** > **Product Key or License Key**, and the **Epson Open Platform** tab > **Authentication System** is displayed on the left of the menu tree.

Printer's control panel

A product key is displayed in Home screen > **Settings** > **Epson Open Platform Information**.

Epson Remote Services Information

Epson Remote Services is a service that periodically collects printer information over the Internet. This can be used to predict when consumables and replacement parts need to be replaced or replenished, and to quickly resolve any errors or problems.

Contact your sales representative for more information about Epson Remote Services.

Where to Get Help

Technical Support Web Site.	276
Contacting Epson Support.	276

Technical Support Web Site

If you need further help, visit the Epson support website shown below. Select your country or region and go to the support section of your local Epson website. The latest drivers, FAQs, manuals, or other downloadables are also available from the site.

<http://support.epson.net/>

<http://www.epson.eu/support> (Europe)

If your Epson product is not operating properly and you cannot solve the problem, contact Epson support services for assistance.

Contacting Epson Support

Before Contacting Epson

If your Epson product is not operating properly and you cannot solve the problem using the troubleshooting information in your product manuals, contact Epson support services for assistance.

The following Epson support list is based on the country of sale. Some products may not be sold in your current location, so be sure to contact Epson support for the area in which you purchased your product.

If Epson support for your area is not listed below, contact the dealer where you purchased your product.

Epson support will be able to help you much more quickly if you give them the following information:

- Product serial number

(The label attachment position depends on the product; it may be on the back, the open side of the cover, or the bottom.)

- Product model

- Product software version

(Click **About**, **Version Info**, or a similar button in the product software.)

- Brand and model of your computer

- Your computer operating system name and version

- Names and versions of the software applications you normally use with your product

Note:

Depending on the product, network settings may be stored in the product's memory. Due to breakdown or repair of a product, settings may be lost. Epson shall not be responsible for the loss of any data, for backing up or recovering settings even during a warranty period. We recommend that you make your own backup data or take notes.

Help for Users in Europe

Check your Pan-European Warranty Document for information on how to contact Epson support.

Help for Users in Taiwan

Contacts for information, support, and services are:

World Wide Web

<http://www.epson.com.tw>

Information on product specifications, drivers for download, and products enquiry are available.

Epson HelpDesk

Phone: +886-2-2165-3138

Our HelpDesk team can help you with the following over the phone:

- Sales enquiries and product information
- Product usage questions or problems
- Enquiries on repair service and warranty

Repair service center:

<http://www.tekcare.com.tw/branchMap.page>

TekCare corporation is an authorized service center for Epson Taiwan Technology & Trading Ltd.

Help for Users in Australia

Epson Australia wishes to provide you with a high level of customer service. In addition to your product manuals, we provide the following sources for obtaining information:

Internet URL

<http://www.epson.com.au>

Access the Epson Australia World Wide Web pages. Worth taking your modem here for the occasional surf! The site provides a download area for drivers, Epson contact points, new product information and technical support (e-mail).

Epson Helpdesk

Phone: 1300-361-054

Epson Helpdesk is provided as a final backup to make sure our clients have access to advice. Operators on the Helpdesk can aid you in installing, configuring and operating your Epson product. Our Pre-sales Helpdesk staff can provide literature on new Epson products and advise where the nearest dealer or service agent is located. Many types of queries are answered here.

We encourage you to have all the relevant information on hand when you ring. The more information you prepare, the faster we can help solve the problem. This information includes your Epson product manuals, type of computer, operating system, application programs, and any information you feel is required.

Transportation of Product

Epson recommends retaining product packaging for future transportation.

Help for Users in New Zealand

Epson New Zealand wishes to provide you with a high level of customer service. In addition to your product documentation, we provide the following sources for obtaining information:

Internet URL

<http://www.epson.co.nz>

Access the Epson New Zealand World Wide Web pages. Worth taking your modem here for the occasional surf! The site provides a download area for drivers, Epson contact points, new product information and technical support (e-mail).

Epson Helpdesk

Phone: 0800 237 766

Epson Helpdesk is provided as a final backup to make sure our clients have access to advice. Operators on the Helpdesk can aid you in installing, configuring and operating your Epson product. Our Pre-sales Helpdesk staff can provide literature on new Epson products and advise where the nearest dealer or service agent is located. Many types of queries are answered here.

We encourage you to have all the relevant information on hand when you ring. The more information you prepare, the faster we can help solve the problem. This information includes your Epson product documentation, type of computer, operating system, application programs, and any information you feel is required.

Transportation of Product

Epson recommends retaining product packaging for future transportation.

Help for Users in Singapore

Sources of information, support, and services available from Epson Singapore are:

World Wide Web

<http://www.epson.com.sg>

Information on product specifications, drivers for download, Frequently Asked Questions (FAQ), Sales Enquiries, and Technical Support via e-mail are available.

Epson HelpDesk

Toll Free: 800-120-5564

Our HelpDesk team can help you with the following over the phone:

- Sales enquiries and product information
- Product usage questions or problem troubleshooting
- Enquiries on repair service and warranty

Help for Users in Thailand

Contacts for information, support, and services are:

World Wide Web

<http://www.epson.co.th>

Information on product specifications, drivers for download, Frequently Asked Questions (FAQ), and e-mail are available.

Epson Call Centre

Phone: 66-2460-9699

Email: support@eth.epson.co.th

Our Call Centre team can help you with the following over the phone:

- Sales enquiries and product information
- Product usage questions or problems
- Enquiries on repair service and warranty

Help for Users in Vietnam

Contacts for information, support, and services are:

Epson Service Center

27 Yen Lang, Trung Liet Ward, Dong Da District, Ha Noi City. Tel: +84 24 7300 0911

38 Le Dinh Ly, Thac Gian Ward, Thanh Khe District, Da Nang. Tel: +84 23 6356 2666

194/3 Nguyen Trong Tuyen, Ward 8, Phu Nhuan Dist., HCMC. Tel: +84 28 7300 0911

31 Phan Boi Chau, Ward 14, Binh Thanh District, HCMC. Tel: +84 28 35100818

Help for Users in Indonesia

Contacts for information, support, and services are:

World Wide Web

<http://www.epson.co.id>

- Information on product specifications, drivers for download
- Frequently Asked Questions (FAQ), Sales Enquiries, questions through e-mail

Epson Hotline

Phone: 1500-766 (Indonesia Only)

Email: customer.care@ein.epson.co.id

Our Hotline team can help you with the following over the phone or email:

- Sales enquiries and product information
- Technical support

Help for Users in Hong Kong

To obtain technical support as well as other after-sales services, users are welcome to contact Epson Hong Kong Limited.

Internet Home Page

<http://www.epson.com.hk>

Epson Hong Kong has established a local home page in both Chinese and English on the Internet to provide users with the following information:

- Product information
- Answers to Frequently Asked Questions (FAQs)
- Latest versions of Epson product drivers

Technical Support Hotline

You can also contact our technical staff at the following telephone and fax numbers:

Phone: 852-2827-8911

Fax: 852-2827-4383

Help for Users in Malaysia

Contacts for information, support, and services are:

World Wide Web

<http://www.epson.com.my>

- Information on product specifications, drivers for download
- Frequently Asked Questions (FAQ), Sales Enquiries, questions through e-mail

Epson Call Centre

Phone: 1800-81-7349 (Toll Free)

Email: websupport@emsb.epson.com.my

- Sales enquiries and product information
- Product usage questions or problems
- Enquiries on repair services and warranty

Epson Malaysia Sdn Bhd (Head Office)

Phone: 603-56288288

Fax: 603-5628 8388/603-5621 2088

Help for Users in India

Contacts for information, support, and services are:

World Wide Web

<http://www.epson.co.in>

Information on product specifications, drivers for download, and products enquiry are available.

Toll Free Helpline

For Service, Product information or to order consumables -

18004250011 / 186030001600 / 1800123001600 (9AM – 6PM)

Email

calllog@epson-india.in

WhatsApp

+91 96400 00333

Help for Users in the Philippines

To obtain technical support as well as other after sales services, users are welcome to contact the Epson Philippines Corporation at the telephone, fax numbers and e-mail address below:

World Wide Web

<http://www.epson.com.ph>

Information on product specifications, drivers for download, Frequently Asked Questions (FAQ), and E-mail Enquiries are available.

Epson Philippines Customer Care

Toll Free: (PLDT) 1-800-1069-37766

Toll Free: (Digitel) 1-800-3-0037766

Metro Manila: +632-8441-9030

Web Site: <https://www.epson.com.ph/contact>

E-mail: customercare@epc.epson.com.ph

Accessible 9am to 6pm, Monday through Saturday (Except public holidays)

Our Customer Care team can help you with the following over the phone:

- Sales enquiries and product information
- Product usage questions or problems
- Enquiries on repair service and warranty

Epson Philippines Corporation

Trunk Line: +632-8706-2609

Fax: +632-8706-2663 / +632-8706-2665