

ASRock®

WS

C621A WS

User Manual

Version 1.0

Published July 2021

Copyright©2021 ASRock INC. All rights reserved.

Copyright Notice:

No part of this documentation may be reproduced, transcribed, transmitted, or translated in any language, in any form or by any means, except duplication of documentation by the purchaser for backup purpose, without written consent of ASRock Inc.

Products and corporate names appearing in this documentation may or may not be registered trademarks or copyrights of their respective companies, and are used only for identification or explanation and to the owners' benefit, without intent to infringe.

Disclaimer:

Specifications and information contained in this documentation are furnished for informational use only and subject to change without notice, and should not be constructed as a commitment by ASRock. ASRock assumes no responsibility for any errors or omissions that may appear in this documentation.

With respect to the contents of this documentation, ASRock does not provide warranty of any kind, either expressed or implied, including but not limited to the implied warranties or conditions of merchantability or fitness for a particular purpose.

In no event shall ASRock, its directors, officers, employees, or agents be liable for any indirect, special, incidental, or consequential damages (including damages for loss of profits, loss of business, loss of data, interruption of business and the like), even if ASRock has been advised of the possibility of such damages arising from any defect or error in the documentation or product.



This device complies with Part 15 of the FCC Rules. Operation is subject to the following two conditions:

- (1) this device may not cause harmful interference, and
- (2) this device must accept any interference received, including interference that may cause undesired operation.

CALIFORNIA, USA ONLY

The Lithium battery adopted on this motherboard contains Perchlorate, a toxic substance controlled in Perchlorate Best Management Practices (BMP) regulations passed by the California Legislature. When you discard the Lithium battery in California, USA, please follow the related regulations in advance.

“Perchlorate Material-special handling may apply, see www.dtsc.ca.gov/hazardouswaste/perchlorate”

ASRock Website: <http://www.asrock.com>

AUSTRALIA ONLY

Our goods come with guarantees that cannot be excluded under the Australian Consumer Law. You are entitled to a replacement or refund for a major failure and compensation for any other reasonably foreseeable loss or damage caused by our goods. You are also entitled to have the goods repaired or replaced if the goods fail to be of acceptable quality and the failure does not amount to a major failure. If you require assistance please call ASRock Tel : +886-2-28965588 ext.123 (Standard International call charges apply)

Contents

Chapter 1 Introduction	1
1.1 Package Contents	1
1.2 Specifications	2
1.3 Motherboard Layout	6
1.4 Onboard LED Indicators	9
1.5 I/O Panel	11
Chapter 2 Installation	14
2.1 Screw Holes	14
2.2 Pre-installation Precautions	14
2.3 Installing the CPU and Heatsink	15
2.4 Installation of Memory Modules (DIMM)	21
2.5 Expansion Slots (PCIe Slots)	23
2.6 Jumper Setup	25
2.7 Onboard Headers and Connectors	27
2.8 Unit Identification purpose LED/Switch	35
2.9 Driver Installation Guide	35
2.10 M.2_SSD (NGFF) Module Installation Guide	36
Chapter 3 UEFI Setup Utility	38
3.1 Introduction	38
3.1.1 UEFI Menu Bar	38
3.1.2 Navigation Keys	39
3.2 Main Screen	

3.2	Main Screen	40
3.3	Advanced Screen	41
3.3.1	CPU Configuration	42
3.3.2	DRAM Configuration	45
3.3.3	Chipset Configuration	47
3.3.4	Storage Configuration	50
3.3.5	ACPI Configuration	51
3.3.6	USB Configuration	52
3.3.7	Super IO Configuration	53
3.3.8	Serial Port Console Redirection	54
3.3.9	H/W Monitor	57
3.3.10	Runtime Error Logging	58
3.3.11	Intel SPS Configuration	60
3.3.12	Intel® VMD technology	61
3.3.13	Tls Auth Configuration	64
3.3.14	Instant Flash	65
3.4	Security	66
3.4.1	Key Management	67
3.5	Boot Screen	70
3.5.1	CSM Parameters	72
3.6	Server Mgmt	74
3.6.1	System Event Log	75
3.6.2	View System Event Log	76

3.6.3	BMC Network Configuration	76
3.6.4	BMC Tools	78
3.7	Event Logs	79
3.8	Exit Screen	80
Chapter 4 Software Support		81
4.1	Install Operating System	81
4.2	Support CD Information	81
4.2.1	Running The Support CD	81
4.2.2	Drivers Menu	81
4.2.3	Utilities Menu	81
4.2.4	Contact Information	81
Chapter 5 Troubleshooting		82
5.1	Troubleshooting Procedures	82
5.2	Technical Support Procedures	84
5.3	Returning Merchandise for Service	84

Chapter 1 Introduction

Thank you for purchasing ASRock C621A WS motherboard, a reliable motherboard produced under ASRock's consistently stringent quality control. It delivers excellent performance with robust design conforming to ASRock's commitment to quality and endurance.

In this manual, chapter 1 and 2 contains introduction of the motherboard and step-by-step guide to the hardware installation. Chapter 3 and 4 contains the configuration guide to BIOS setup and information of the Support CD.



Because the motherboard specifications and the BIOS software might be updated, the content of this documentation will be subject to change without notice. In case any modifications of this documentation occur, the updated version will be available on ASRock's website without further notice. If you require technical support related to this motherboard, please visit our website for specific information about the model you are using. You may find the latest VGA cards and CPU support list on ASRock's website as well. ASRock website <http://www.asrock.com>.

1.1 Package Contents

- ASRock C621A WS Motherboard (ATX Form Factor)
- ASRock C621A WS Quick Installation Guide
- ASRock C621A WS Support CD
- 1 x TPM-SPI module
- 1 x CPU Non-Fabric Carrier (Optional)
- 1 x Mini SAS HD to 4*SATA Cable (60cm) (Optional)
- 1 x SATA Power Cable (80cm) (Optional)
- 1 x SATA3 Data Cable (60cm) (Optional)
- 1 x I/O Panel Shield



If any items are missing or appear damaged, contact your authorized dealer.

1.2 Specifications

- Platform**
- ATX Form Factor
 - 12 Layer PCB
 - 2oz Copper PCB

- CPU**
- Supports 3rd Generation Intel® Xeon® Scalable Processors
 - Intel® Socket 4189 (Socket P+)
 - Digi Power Design
 - 7 Power Phase Design

- Chipset**
- Intel® C621A

- Memory**
- Eight Channel Memory Technology (1DPC)
 - 8 x DDR4 DIMM Slots
 - Supports DDR4 3200/2933/2666/2400/2133/1866 DDR4 RDIMM/ RDIMM-3DS/ LRDIMM/ LRDIMM-3DS/ Intel® Optane™ Persistent Memory 200 Series
 - Max. capacity of system memory: RDIMM: 64GB, LRDIMM: 128GB, RDIMM-3DS/ LRDIMM-3DS: 256GB

- Expansion Slot**
- 4 x PCIe Gen4x16 Slots (PCIE1/PCIE3/PCIE5/PCIE7)*
 - 3 x PCIe Gen4x8 Slots (PCIE2/PCIE4/PCIE6)*
- * If PCIE2 is occupied, PCIE3 will downgrade to x8 mode. If PCIE4 is occupied, PCIE5 will downgrade to x8 mode. If PCIE6 is occupied, PCIE7 will downgrade to x8 mode.

- Graphics**
- Aspeed® AST2500 BMC Controller
 - Supports D-Sub with max. resolution up to 1920x1200 @ 60Hz

- LAN**
- 2 x 10 Gigabit LAN 100/1000/2500/5000/10000 Mb/s (Intel® X710-AT2)
- Supports Wake-On-LAN
 - Supports Lightning/ESD Protection
 - Supports Energy Efficient Ethernet 802.3az
 - Supports PXE

2 x Gigabit LAN 10/100/1000 Mb/s (Intel® I210)

- Supports Wake-On-LAN
- Supports Lightning/ESD Protection
- Supports Energy Efficient Ethernet 802.3az
- Supports PXE

1 x Dedicated IPMI (ASPEED AST2500)

- Supports iKVM and vMedia

Storage

- 2 x SATA3 6.0 Gb/s Connectors
- 1 x Mini-SAS HD Connector
- 1 x Ultra M.2 Socket (M2_1, Key M), supports type 2242/2280/22110 SATA3 6.0 Gb/s & PCIe Gen3x4 (32 Gb/s) modes*
- 1 x M.2 Socket (M2_2, Key M), supports type 2242/2280/22110 SATA3 6.0 Gb/s & PCIe Gen3x1 (8 Gb/s) modes*

* Supports Intel® Optane™ Technology

* Supports NVMe SSD as boot disks

* Supports ASRock U.2 Ki

RAID

- Supports RAID 0, RAID 1, RAID 5 and RAID 10 for SATA storage devices
- Supports RAID 0, RAID 1, RAID 5 for M.2 NVMe storage devices

Rear Panel I/O

- 1 x UID Switch w/ LED
- 1 x D-Sub Port
- 4 x USB 3.2 Gen1 Ports (Supports ESD Protection)
- 2 x RJ45 (10GbE), 2 x RJ45 (1GbE)
- 1 x RJ45 Dedicated IPMI LAN port

Connector

- 1 x SPI TPM Header
- 1 x LPC TPM Header
- 1 x COM Port Header
- 5 x System Fan Connectors (6-pin)
- 1 x 24 pin ATX Power Connector (Hi-Density Power Connector)

- 1 x 8 pin 12V Power Connector (Hi-Density Power Connector)
- 1 x 4 pin 12V Power Connector (Hi-Density Power Connector)
- 1 x Vertical Type A USB 2.0
- 1 x USB 2.0 Header (Supports 2 USB 2.0 ports) (Supports ESD Protection)
- 1 x USB 3.2 Gen1 Headers (Support 2 USB 3.2 Gen1 ports) (Supports ESD Protection)
- 2 x USB3.2 Gen2 ports (2 Type-C headers)
- 2 x Front Panel Type C USB 3.2 Gen2 Headers (Supports ESD Protection)
- 2 x SGPIO Headers
- 1 x Auxiliary Panel Header
- 1 x Intelligent Platform Management Bus Header
- 1 x Backplane PCI Express Hot-Plug Connector Header
- 1 x SMBus Header
- 1 x PMbus Header
- 1 x CPU HP-SMBus Connector
- 1 x Thermal Sensor Header
- 1 x Virtual RAID On CPU Header
- 1 x BMC Heartbeat LED
- 1 x StandbyPower LED
- 5 x FanFail LED
- 1 x Non Maskable Interrupt Button Header
- 1 x Buzzer
- 1 x Dr. Debug with LED

**BIOS
Feature**

- AMI UEFI Legal BIOS
- ACPI 5.0 Compliant wake up events
- SMBIOS 2.3 Support

**Hardware
Monitor**

- Temperature Sensing: CPU, PCH, MB, Card Side
- Fan Tachometer: CPU, Rear, Front Fan Tachometer
- Quiet Fan (Auto adjust chassis fan speed by CPU temperature): CPU Fan
- Fan Multi-Speed Control: CPU, Rear, Front Fan
- Voltage Monitoring: CPU1_PVCCIN, PVDDQ_ABCD, PVDDQ_EFGH, 1.05V_PCH, 1.8V_PCH, +BAT, PVNN_PCH, 3.3V, 5V, 12V, 3.3VSB, 5VSB

OS

Microsoft® Windows®

- 10 64-bit / 11 64-bit
- Server 2016 (64 bit)
- Server 2019 (64 bit)
- Server 2022 (64 bit)

Linux®:

- Red Hat Enterprise Linux Server 7.9 (64 bit) / 8.3 (64 bit)
- CentOS 7.9 (64 bit) / 8.3 (64 bit)
- SUSE Enterprise Linux Server 12 SP5 (64 bit) / 15 SP2 (64 bit)
- Ubuntu 20.04.1 (64 bit) / 20.10 (64 bit)

Hypervisor:

- VMWare® ESXi 6.7 U3 / vSphere 6.7 U3
- VMWare® ESXi 7.0.U1c / vSphere 7.0.U1c
- Hyper-V Windows Server 2016
- Hyper-V Windows Server 2019

** Please refer to our website for the latest OS support list.*

Certifications

- FCC, CE
- ErP/EuP ready (ErP/EuP ready power supply is required)

** For detailed product information, please visit our website: <http://www.asrock.com>*



Please realize that there is a certain risk involved with overclocking, including adjusting the setting in the BIOS, applying Untied Overclocking Technology, or using third-party overclocking tools. Overclocking may affect your system's stability, or even cause damage to the components and devices of your system. It should be done at your own risk and expense. We are not responsible for possible damage caused by overclocking.

1.3 Motherboard Layout

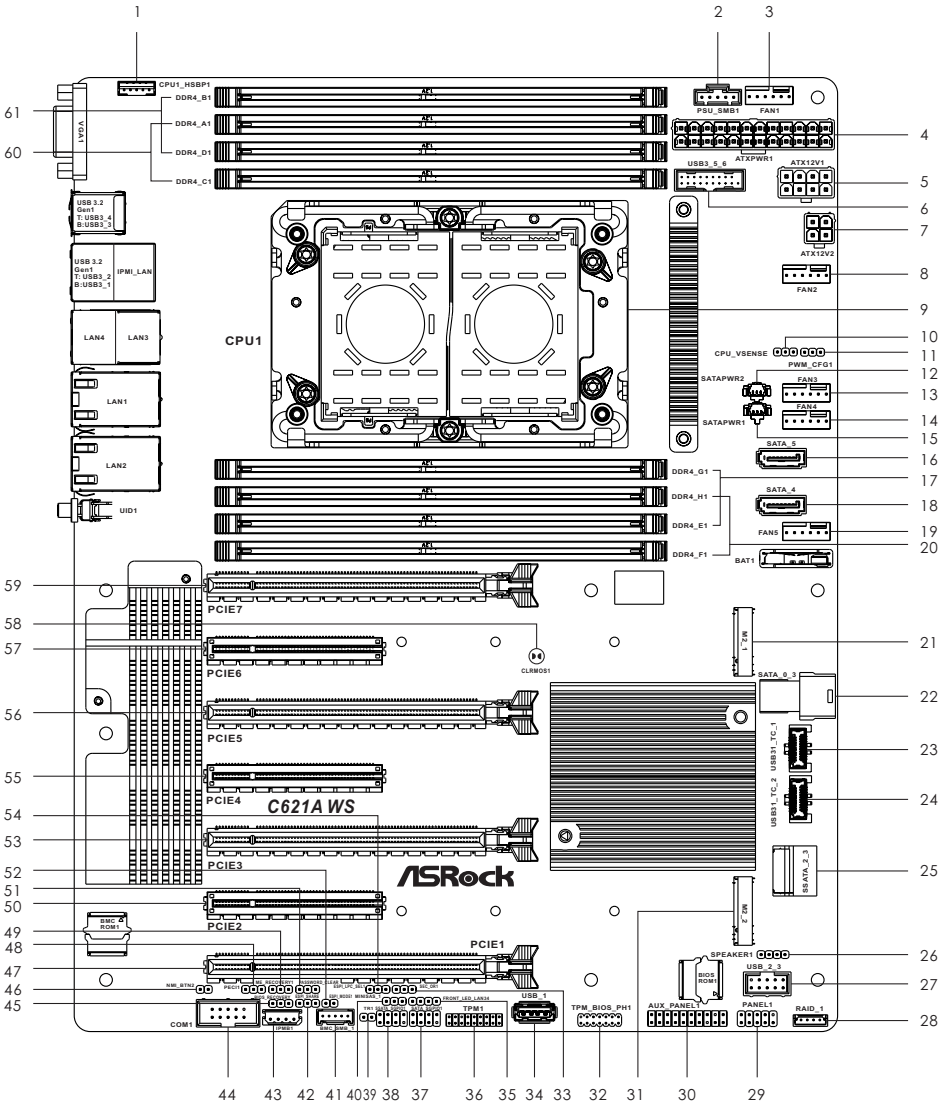

No.	Description
1	Backplane PCI Express Hot-Plug Connector (CPU1_HSBP1)
2	PSU SMBus Header (PSU_SMB1)
3	System Fan Connector (FAN1)
4	ATX Power Connector (ATXPWR1)
5	ATX 12V Power Connector (ATX12V1)
6	USB 3.2 Gen1 Header (USB3_5_6)
7	ATX 12V Power Connector (ATX12V2)
8	System Fan Connector (FAN2)
9	LGA 4189 CPU Socket (CPU1)
10	CPU VSENSE Header (CPU_VSENSE)
11	PWM Configuration Header (PWM_CFG1)
12	SATA DOM Power Connector (SATAPWR2)
13	System Fan Connector (FAN3)
14	System Fan Connector (FAN4)
15	SATA DOM Power Connector (SATAPWR1)
16	SATA3 DOM Connector (SATA_5)
17	2 x 288-pin DDR4 DIMM Slots (DDR4_E1, DDR4_G1)*
18	SATA3 DOM Connector (SATA_4)
19	System Fan Connector (FAN5)
20	2 x 288-pin DDR4 DIMM Slots (DDR4_F1, DDR4_H1)*
21	M.2 Socket (M2_1) (Type 2242/2280/22110)
22	Mini-SAS HD Connector (SATA_0_3)
23	Front Panel Type C USB 3.2 Gen2 Header (USB31_TC_1)**
24	Front Panel Type C USB 3.2 Gen2 Header (USB31_TC_2)**
25	SATA3 Connectors (SSATA_3)(Upper), (SSATA3_2)(Lower)**
26	Speaker Header (SPEAKER1)
27	USB 2.0 Header (USB_2_3)
28	Virtual RAID On CPUHeader (RAID_1)
29	System Panel Header (PANEL1)
30	Auxiliary Panel Header (AUX_PANEL1)
31	M.2 Socket (M2_2) (Type 2242/2280/22110)
32	TPM-SPI Header (TPM_BIOS_PH1)
33	Security Override Jumper (SEC_OR1)

No.	Description
34	Vertical USB 2.0 Port (USB_1)
35	Front LAN LED Header (FRONT_LED_LAN34)
36	TPM Header (TPM1)
37	SATA SGPIO Connector (SATA_SGPIO1)
38	SATA SGPIO Connector (SSATA_SGPIO1)
39	Thermal Sensor Header (TR1)
40	MiniSAS HD SATA/PCIE Slection Jumper (MINISAS_1)
41	BMC SMBus Header (BMC_SMB_1)
42	ESPI Flash Sharing Jumper (ESPI_SHARE)
43	Intelligent Platform Management Bus Header (IPMB1)
44	COM Header (COM1)
45	BIOS Recovery Jumper (BIOS_RECOVERY1)
46	Non Maskable Interrupt Button (NMI_BTN2)
47	PCI Express 4.0 x16 Card Slot (PCIE1)
48	CPU PECl Mode Jumper (PECl1)
49	ME Recovery Jumper (ME_RECOVERY1)
50	PCI Express 4.0 x8 Card Slot (PCIE2)
51	Password Reset Jumper (PASSWORD_CLEAR)
52	BIOS Swap Override Header (ESPI_MODE1)
53	PCI Express 4.0 x16 Card Slot (PCIE3)
54	ESPI/LPC Selection Jumper (ESPI_LPC_SEL1)
55	PCI Express 4.0 x8 Card Slot (PCIE4)
56	PCI Express 4.0 x16 Card Slot (PCIE5)
57	PCI Express 4.0 x8 Card Slot (PCIE6)
58	Clear CMOS Pad (CLRMOS1)
59	PCI Express 4.0 x16 Card Slot (PCIE7)
60	2 x 288-pin DDR4 DIMM Slots (DDR4_A1, DDR4_C1)*
61	2 x 288-pin DDR4 DIMM Slots (DDR4_B1, DDR4_D1)*

*For DIMM installation and configuration instructions, please see p.21 (Installation of Memory Modules (DIMM)) for more details.

**2 Type-C USB headers (USB31_TC1/USB31_TC2) are shared with 2 SATA 7-pin headers (SSATA_2/SSATA_3) (BOM option)

1.4 Onboard LED Indicators

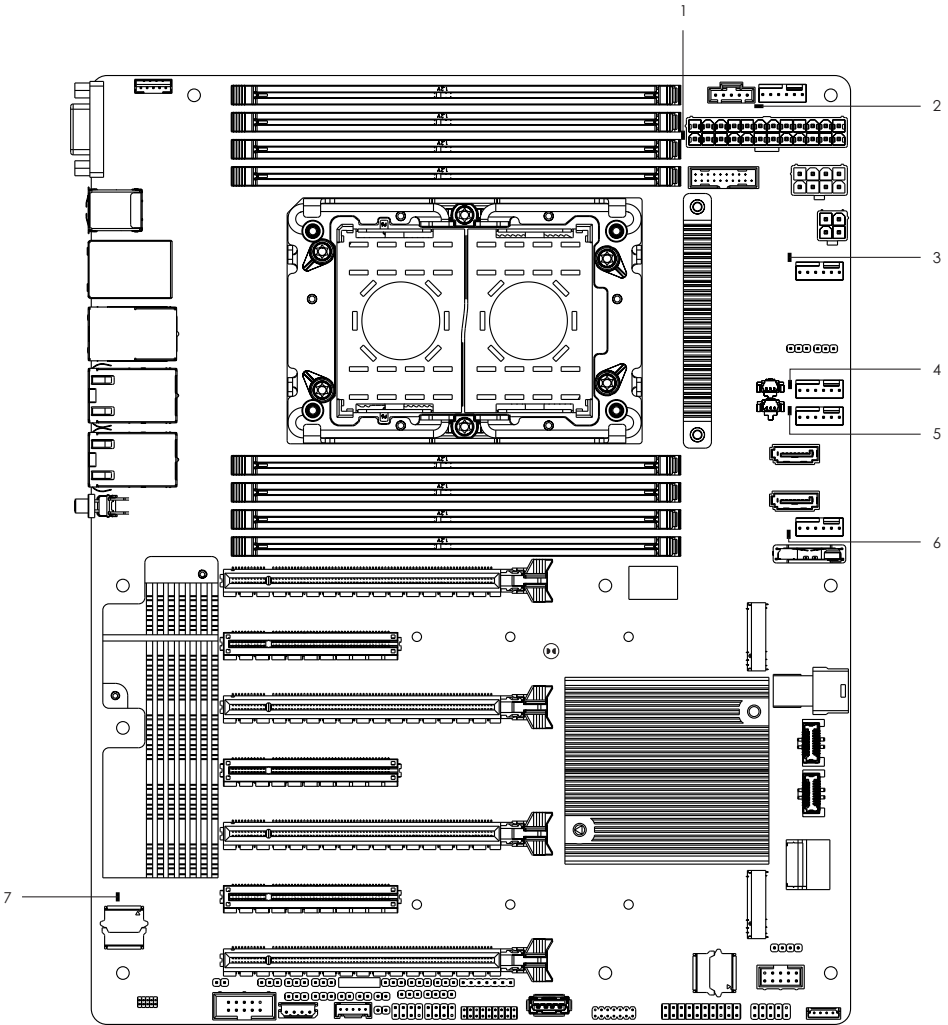

No.	Item	Status	Description
1	SB_PWR1	Green	STB PWR ready
2	FAN_LED1	Amber	FAN1 failed
3	FAN_LED2	Amber	FAN2 failed
4	FAN_LED3	Amber	FAN3 failed
5	FAN_LED4	Amber	FAN4 failed
6	FAN_LED5	Amber	FAN5 failed
7	BLED1	Green	BMC heartbeat LED

1.5 I/O Panel

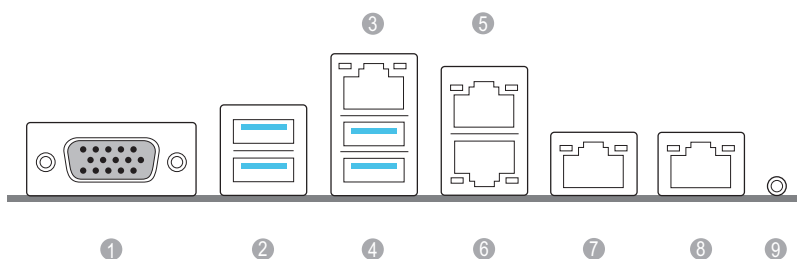

No.	Description	No.	Description
1	VGA Port (VGA1)	6	1G LAN RJ-45 Port (LAN4)**
2	USB 3.2 Gen1 Ports (USB3_3_4)	7	10G LAN RJ-45 Port (LAN1)***
3	LAN RJ-45 Port (IPMI_LAN)*	8	10G LAN RJ-45 Port (LAN2)***
4	USB 3.2 Gen1 Ports (USB3_1_2)	9	UID Switch (UID1)
5	1G LAN RJ-45 Port (LAN3)**		

*There are two LED next to the LAN port. Please refer to the table below for the LAN port LED indications.

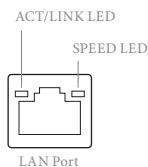

Dedicated IPMI LAN Port LED Indications

Activity / Link LED		Speed LED	
Status	Description	Status	Description
Off	No Link	Off	10M bps connection or no link
Blinking Orange	Data Activity	Yellow	100M bps connection
On	Link	Green	1G bps connection

**There are two LEDs on each LAN port. Please refer to the table below for the LAN port LED indications.

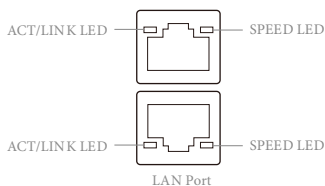

LAN Port (LAN3, LAN4) LED Indications

Activity / Link LED		Speed LED	
Status	Description	Status	Description
Off	No Link	Off	10Mbps connection or no link
Blinking Yellow	Data Activity	Yellow	100Mbps connection
On	Link	Green	1Gbps connection

***There are two LEDs on each LAN port. Please refer to the table below for the LAN port LED indications.

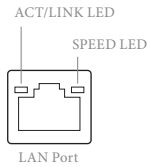

LAN Port (LAN1, LAN2) LED Indications

Activity / Link LED		Speed LED	
Status	Description	Status	Description
Off	No Link	Off	100Mbps connection or no link
Blinking Green	Data Activity	Yellow	1Gbps connection
On	Link	Green	10Gbps connection

Chapter 2 Installation

This is an ATX form factor (12" x 9.6", 30.5 cm x 24.4 cm) motherboard. Before you install the motherboard, study the configuration of your chassis to ensure that the motherboard fits into it.



Make sure to unplug the power cord before installing or removing the motherboard. Failure to do so may cause physical injuries to you and damages to motherboard components.

2.1 Screw Holes

Place screws into the holes indicated by circles to secure the motherboard to the chassis.



Do not over-tighten the screws! Doing so may damage the motherboard.

2.2 Pre-installation Precautions

Take note of the following precautions before you install motherboard components or change any motherboard settings.

1. Unplug the power cord from the wall socket before touching any components.
2. To avoid damaging the motherboard's components due to static electricity, NEVER place your motherboard directly on the carpet or the like. Also remember to use a grounded wrist strap or touch a safety grounded object before you handle the components.
3. Hold components by the edges and do not touch the ICs.
4. Whenever you uninstall any component, place it on a grounded anti-static pad or in the bag that comes with the component.
5. When placing screws into the screw holes to secure the motherboard to the chassis, please do not over-tighten the screws! Doing so may damage the motherboard.



Before you install or remove any component, ensure that the power is switched off or the power cord is detached from the power supply. Failure to do so may cause severe damage to the motherboard, peripherals, and/or components.

2.3 Installing the CPU and Heatsink



1. Before you insert the CPU into the socket, please check if the PnP cap is on the socket, if the CPU surface is unclean, or if there are any bent pins in the socket. Do not force to insert the CPU into the socket if above situation is found. Otherwise, the CPU will be seriously damaged.
2. Unplug all power cables before installing the CPU.

1

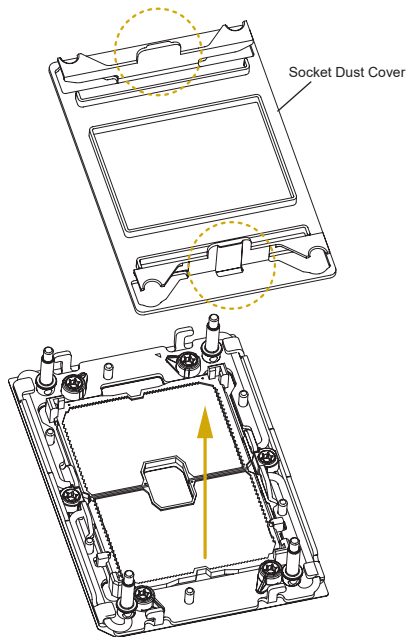



1. Before you installed the heatsink, you need to spray thermal interface material between the CPU and the heatsink to improve heat dissipation.
2. Illustration in this documentation are examples only. Heatsink or fan cooler type may differ.

2

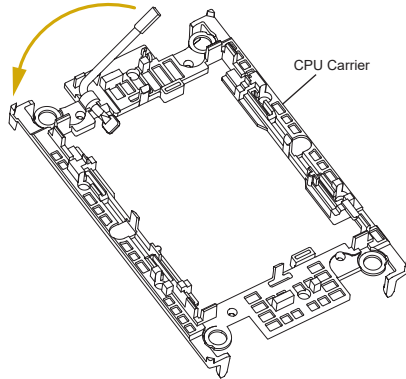

3

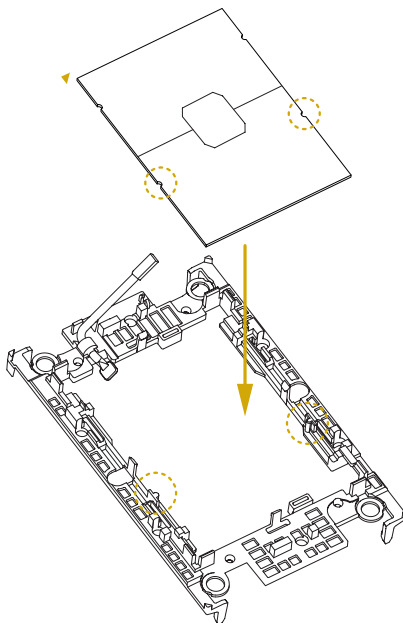

4

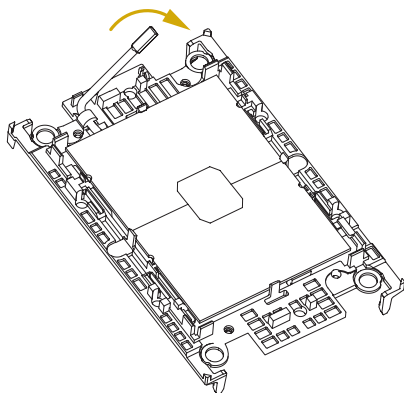

5

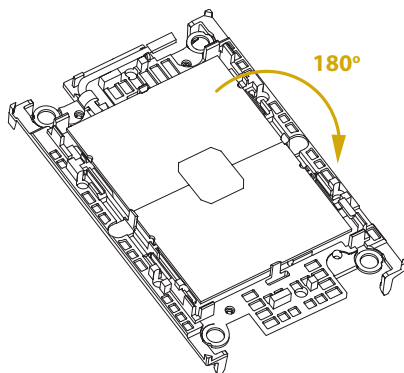

6

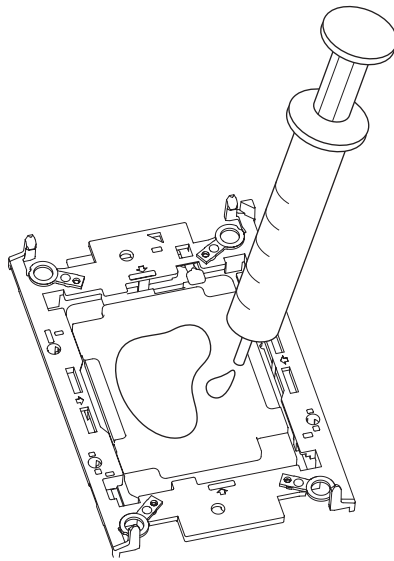

7

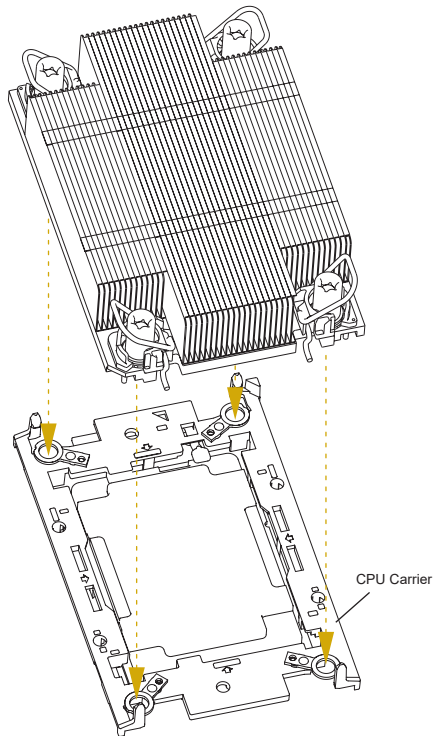

8

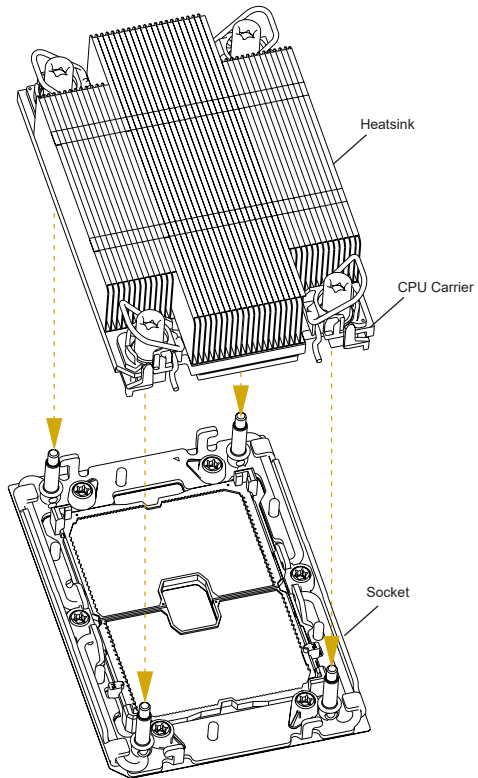

9

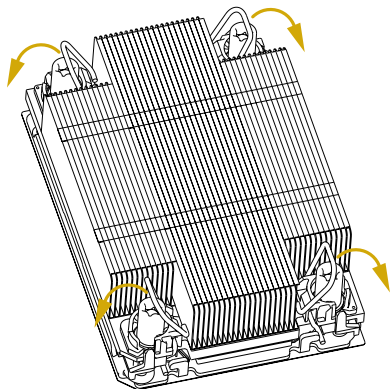

10

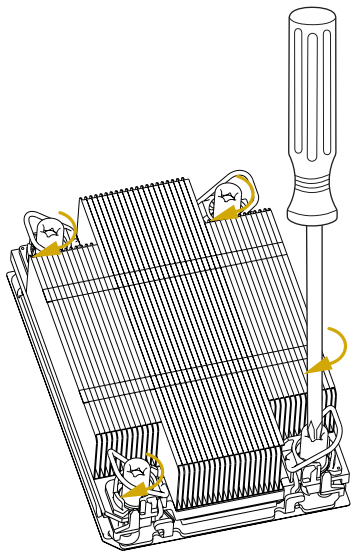

2.4 Installation of Memory Modules (DIMM)

This motherboard provides eight 288-pin DDR4 (Double Data Rate 4) DIMM slots in two groups, and supports Eight Channel Memory Technology.

	CPU1							
	A1	B1	C1	D1	E1	F1	G1	H1
1 DIMM			#					
2 DIMMS			#				#	
4 DIMMS			#	#			#	#
8 DIMMS	#	#	#	#	#	#	#	#



1. It is not allowed to install a DDR, DDR2 or DDR3 memory module into a DDR4 slot; otherwise, this motherboard and DIMM may be damaged.
2. For eight channel configuration, you always need to install identical (the same brand, speed, size and chip-type) DDR4 DIMM pairs.

1

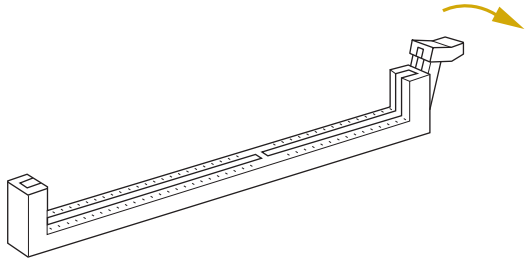

2

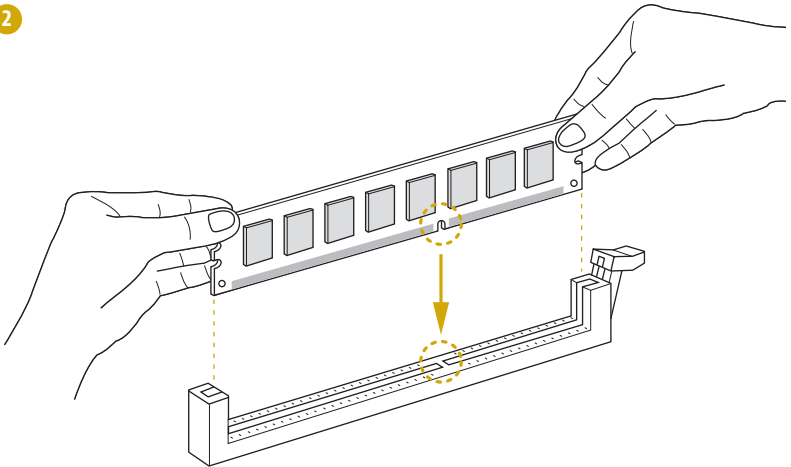

3

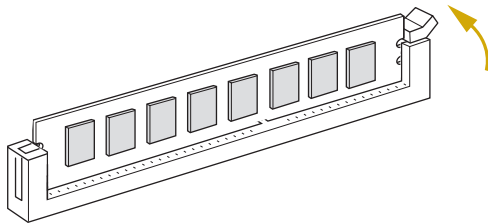

2.5 Expansion Slots (PCIe Slots)

There are 7 PCIe slots on this motherboard.

PCIe slot:

PCIe1, PCIe3, PCIe5 and PCIe7 (PCIe 4.0 x16 slot, from CPU1) are used for PCIe x16 lane width cards.

PCIe2, PCIe4 and PCIe6 (PCIe 4.0 x8 slot, from CPU1) are used for PCIe x8 lane width cards.

Slot	Generation	Mechanical	Electrical	Source
PCIe7	4.0	x16	x16	CPU1
PCIe6	4.0	x8	x8	CPU1
PCIe5	4.0	x16	x16	CPU1
PCIe4	4.0	x8	x8	CPU1
PCIe3	4.0	x16	x16	CPU1
PCIe2	4.0	x8	x8	CPU1
PCIe1	4.0	x16	x16	CPU1

PCIe Slot Configurations

	PCIe2	PCIe3
Single PCIe Card	N/A	x16

Two PCIe Cards x8 x8

	PCIe4	PCIe5
Single PCIe Card	N/A	x16

Two PCIe Cards x8 x8

	PCIe6	PCIe7
Single PCIe Card	N/A	x16

Two PCIe Cards x8 x8

Installing an expansion card

- Step 1. Before installing an expansion card, please make sure that the power supply is switched off or the power cord is unplugged. Please read the documentation of the expansion card and make necessary hardware settings for the card before you start the installation.
- Step 2. Remove the system unit cover (if your motherboard is already installed in a chassis).
- Step 3. Remove the bracket facing the slot that you intend to use. Keep the screws for later use.
- Step 4. Align the card connector with the slot and press firmly until the card is completely seated on the slot.
- Step 5. Fasten the card to the chassis with screws.
- Step 6. Replace the system cover.

2.6 Jumper Setup

The illustration shows how jumpers are setup. When the jumper cap is placed on the pins, the jumper is “Short”. If no jumper cap is placed on the pins, the jumper is “Open”. The illustration shows a 3-pin jumper whose pin1 and pin2 are “Short” when a jumper cap is placed on these 2 pins.

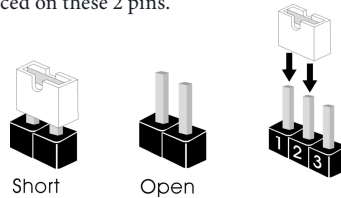

MiniSAS HD SATA/PCIE
Selection Jumper
(3-pin MINISAS_1)
(see p.6, No. 40)



SATA (Default)



PCIE

CPU PECI Mode Jumper
(3-pin PECI1)
(see p.6, No. 48)



CPU PECI connected to
PCH



CPU PECI connected to
BMC (Default)

Security Override Jumper
(3-pin SEC_OR1)
(see p.6, No. 33)



Descriptor Security
Override



Not override (Default)

ME Recovery Jumper
(3-pin ME_RECOVERY1)
(see p.6, No. 49)



Normal Mode (Default)



ME Recovery Mode







Password Reset Jumper
(3-pin PASSWORD_
CLEAR)
(see p.6, No. 51)



Normal Mode (Default)



Password Clear

BIOS Recovery Jumper (3-pin BIOS_RECOVERY1) (see p.6, No. 45)	1_2 	2_3 
	Normal Mode (Default)	Recover BIOS
ESPI/LPC Selection Jumper (3-pin ESPI_LPC_SEL1) (see p.6, No. 54)	1_2 	2_3 
	ESPI (Default)	LPC
ESPI Flash Sharing Jumper (3-pin ESPI_SHARE) (see p.6, No. 42)	1_2 	2_3 
	Master ESPI Flash Sharing (Default)	Slave ESPI Flash Sharing

The illustration shows how jumpers are setup. When the jumper cap is placed on the pins, the jumper is “Short”. If no jumper cap is placed on the pins, the jumper is “Open”.

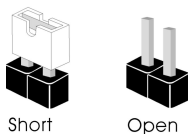

BIOS Swap Override Jumper (ESPI_MODE1) (see p.6, No. 52)	1_2 	Open: Disable Override (Default) Short: Enable Override
	2-pin Jumper	

2.7 Onboard Headers and Connectors



Onboard headers and connectors are NOT jumpers. Do NOT place jumper caps over these headers and connectors. Placing jumper caps over the headers and connectors will cause permanent damage to the motherboard.

System Panel Header
(9-pin PANEL1)
(see p.6, No. 29)

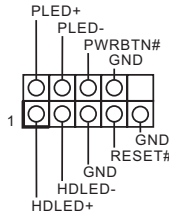

Connect the power switch, reset switch and system status indicator on the chassis to this header according to the pin assignments. Particularly note the positive and negative pins before connecting the cables.



PWRBTN (Power Switch):

Connect to the power switch on the chassis front panel. You may configure the way to turn off your system using the power switch.

RESET (Reset Switch):

Connect to the reset switch on the chassis front panel. Press the reset switch to restart the computer if the computer freezes and fails to perform a normal restart.

PLED (System Power LED):

Connect to the power status indicator on the chassis front panel. The LED is on when the system is operating. The LED is off when the system is in S4 sleep state or powered off (S5).

HDLED (Hard Drive Activity LED):

Connect to the hard drive activity LED on the chassis front panel. The LED is on when the hard drive is reading or writing data.

The front panel design may differ by chassis. A front panel module mainly consists of power switch, reset switch, power LED, hard drive activity LED, speaker and etc. When connecting your chassis front panel module to this header, make sure the wire assignments and the pin assignments are matched correctly.

Auxiliary Panel Header
(18-pin AUX_PANEL1)
(see p.6, No. 30)

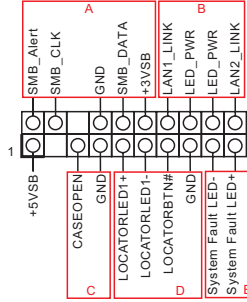

This header supports multiple functions on the front panel, including the front panel SMB, internet status indicator and chassis intrusion pin.



A. Front panel SMBus connecting pin (6-1 pin FPSMB)

This header allows you to connect SMBus (System Management Bus) equipment. It can be used for communication between peripheral equipment in the system, which has slower transmission rates, and power management equipment.

B. Internet status indicator (2-pin LAN1_LED, LAN2_LED)

These two 2-pin headers allow you to use the Gigabit internet indicator cable to connect to the LAN status indicator. When this indicator flickers, it means that the internet is properly connected.

C. Chassis intrusion pin (2-pin CHASSIS)

This header is provided for host computer chassis with chassis intrusion detection designs. In addition, it must also work with external detection equipment, such as a chassis intrusion detection sensor or a microswitch. When this function is activated, if any chassis component movement occurs, the sensor will immediately detect it and send a signal to this header, and the system will then record this chassis intrusion event. The default setting is set to the CASEOPEN and GND pin; this function is off.

D. Locator LED (4-pin LOCATOR)

This header is for the locator switch and LED on the front panel.

E. System Fault LED (2-pin LOCATOR)

This header is for the Fault LED on the system.

Mini-SAS HD Connector

Right-Angle:

(SATA_0_3)

(see p.6, No. 22)

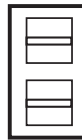

This connector supports MiniSAS-to-SATA data cables for internal storage devices with up to 6.0 Gb/s data transfer rate.

USB 3.2 Gen1 Header
(19-pin USB3_5_6)
(see p.6, No. 6)

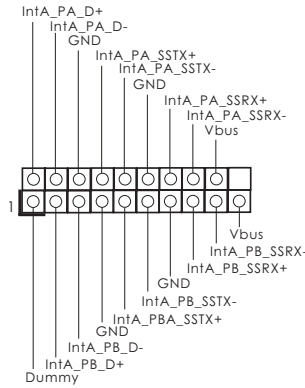

Besides four default USB 3.2 Gen1 ports on the I/O panel, there is one USB 3.2 Gen1 header on this motherboard. This USB 3.2 Gen1 header can support two USB 3.2 Gen1 ports.

System Fan Connectors
(6-pin FAN1)
(6-pin FAN2)
(6-pin FAN3)
(6-pin FAN4)
(6-pin FAN5)
(see p.6, No. 3, 8, 13, 14, 19)

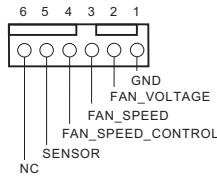

Please connect fan cables to the fan connectors and match the black wire to the ground pin. All fans support Fan Control.

Front Panel Type C USB
3.2 Gen2 Headers
(20-pin USB31_TC_1)
see p.6, No. 23)
(20-pin USB31_TC_2)
(see p.6, No. 24)



There are two Front Panel Type C USB 3.2 Gen2 Header on this motherboard. These headers are used for connecting USB 3.2 Gen2 modules for additional USB 3.2 Gen2 ports.

**2 Type-C USB headers (USB31_TC1/USB31_TC2) are shared with 2 SATA 7-pin headers (SSATA_2/SSATA_3) (BOM option).*

USB 2.0 Connector
(USB_1)
(see p.6, No. 34)



There is one vertical USB 2.0 port on this motherboard.

USB 2.0 Header
(9-pin USB_2_3)
(see p.6, No. 27)

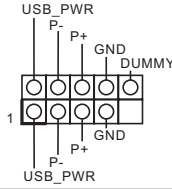

This is one header on this motherboard. This USB 2.0 header can support two ports.

ATX Power Connector
(24-pin ATXPWR1)
(see p.6, No. 4)

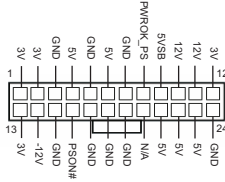

This motherboard provides a 24-pin ATX power connector. To use a 20-pin ATX power supply, please plug it along Pin 1 and Pin 13.

ATX 12V Power Connectors
(8-pin ATX12V1)
(see p.6, No. 5)

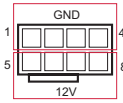

This motherboard provides one 8-pin and one 4-pin ATX 12V power connectors.

(4-pin ATX12V2)
(see p.6, No. 7)

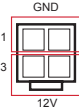

SATA DOM Power Connector
(3-pin SATAPWR1)
(see p.6, No. 15)
(3-pin SATAPWR2)
(see p.6, No. 12)

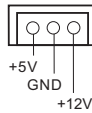

Please use a SATA power cable to connect this SATA Power Connector and your SATA HDD for supplying power from the motherboard, when using DC-IN mode without SATA power supply.

TPM Header
(17-pin TPM1)
(see p.6, No. 36)

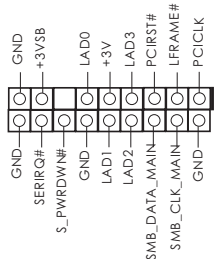

This connector supports Trusted Platform Module (TPM) system, which can securely store keys, digital certificates, passwords, and data. A TPM system also helps enhance network security, protects digital identities, and ensures platform integrity.

TPM-SPI Header
(13-pin TPM_BIOS_PH1)
(see p.6, No. 32)

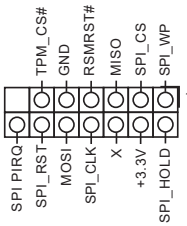

This connector supports Trusted Platform Module (TPM) system for SPI interface, which can securely store keys, digital certificates, passwords, and data. A TPM system also helps enhance network security, protects digital identities, and ensures platform integrity.

PSU SMBus Header
(5-pin PSU_SMB1)
(see p.6, No. 2)

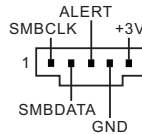

PSU SMBus monitors the status of the power supply, fan and system temperature.

Intelligent Platform
Management Bus Header
(4-pin IPMB1)
(see p.6, No. 23)

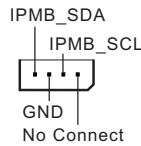

This 4-pin connector is used to provide a cabled base-board or front panel connection for value added features and 3rd-party add-in cards, such as Emergency Management cards, that provide management features using the IPMB.

Baseboard Management
Controller SMBus Header
(5-pin BMC_SMB_1)
(see p.6, No. 41)

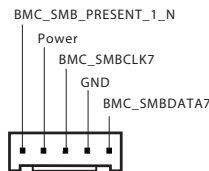

The header is used for the SMBUS devices.

CPU HP-SMBus Connector
(5-pin CPU1_HSBP1)
(see p.6, No. 1)

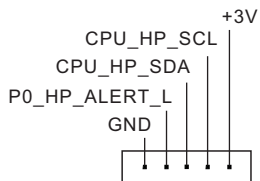

This header is used for the hot plug feature of HDDs on the backplane.

Serial ATA3 DOM
Connectors
(SATA_4)
(see p.6, No. 18)
(SATA_5)
(see p.6, No. 16)



The SATA3 DOM connectors support both SATA DOMs (Disk-On-Module) and SATA data cables for internal storage devices.

Serial ATA3 Connectors
Vertical:
(SATA_4)
(see p.6, No. 18)
(SATA_5)
(see p.6, No. 16)



These two SATA3 connectors support SATA data cables for internal storage devices with up to 6.0 Gb/s data transfer rate.

**2 Type-C USB headers (USB31_TC1/USB31_TC2) are shared with 2 SATA 7-pin headers (SSATA_2/SSATA_3) (BOM option).*

Serial Port Header
(9-pin COM1)
(see p.6, No. 44)

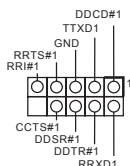

This COM header supports a serial port module.

Clear CMOS Pad
(CLRMO51)
(see p.6, No. 58)



This allows you to clear the data in CMOS. To clear CMOS, take out the CMOS battery and short the Clear CMOS Pad.

Non Maskable Interrupt
Button Header
(NMI_BTN2)
(see p.6, No. 46)



Please connect a NMI device to this header.

Thermal Sensor Header
(2-pin TR1)
(see p.6, No. 39)

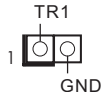

Please connect the thermal sensor cable to either pin 1-2 or pin 2-3 and the other end to the device which you wish to monitor its temperature.

Front LAN LED Header
(4-pin FRONT_LED_ LAN34)
(see p.6, No. 35)

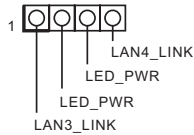

This 4-pin connector is used for the front LAN status indicator.

Chassis Speaker Header
(4-pin SPEAKER1)
(see p.6, No. 26)

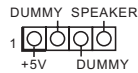

Please connect the chassis speaker to this header.

Serial General Purpose
Input/Output Headers
(7-pin SATA_SGPI01)
(see p.6, No. 37)
(7-pin SSATA_SGPI01)
(see p.6, No. 38)

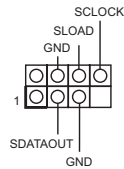

The headers support Serial Link interface for onboard SATA connections.

PWM Configuration
Header
(3-pin PWM_CFG1)
(see p.6, No. 11)

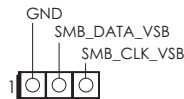

This header is used for PWM configurations.

CPU VSENSE Header
(3-pin CPU_VSENSE)
(see p.6, No. 10)

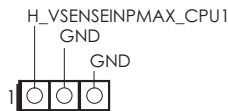

This header is used to detect CPU1 VSENSE.

Virtual RAID On CPU
Header
(4-pin RAID_1)
(see p.6, No. 28)

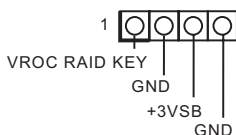

This connector supports Intel® Virtual RAID on CPU and NVME/AHCI RAID on CPU PCIE.

With the introduction of the Intel VROC product, there are three modes of operation:

SKU	HW key required	Key features
Pass-thru	Not needed	<ul style="list-style-type: none"> • Pass-thru only (no RAID) • LED Management • Hot Plug Support • RAID 0 support for Intel Fultondale NVMe SSDs
Standard	VROCSTANMOD	<ul style="list-style-type: none"> • Pass-thru SKU features • RAID 0, 1, 10
Premium	VROCPREMMOD	<ul style="list-style-type: none"> • Standard SKU features • RAID 5
ISS	VROCISSDMOD	<ul style="list-style-type: none"> • RAID 5 Write Hole Closure

*Only Intel SSDs are supported.

*For further details on VROC, please refer to the official information released by Intel.

2.8 Unit Identification purpose LED/Switch

With the UID button, You are able to locate the server you're working on from behind a rack of servers.

Unit Identification
purpose LED/Switch
(UID1)
(see p.11, No. 9)



When the UID button on the front or rear panel is pressed, the front/rear UID blue LED indicator will be turned on. Press the UID button again to turn off the indicator.

2.9 Driver Installation Guide

To install the drivers to your system, please insert the support CD to your optical drive first. Then, the drivers compatible to your system can be auto-detected and listed on the support CD driver page. Please follow the order from top to bottom to install those required drivers. Therefore, the drivers you install can work properly.

2.10 M.2_SSD (NGFF) Module Installation Guide

The M.2, also known as the Next Generation Form Factor (NGFF), is a small size and versatile card edge connector that aims to replace mPCIe and mSATA.

The Ultra M.2 Socket (M2_1) supports a M.2 SATA3 6.0 Gb/s module or a M.2 PCI Express module up to Gen3 x4 (32Gb/s). The M.2 Socket (M2_2) supports a M.2 SATA3 6.0 Gb/s module or a M.2 PCI Express module up to Gen3 x1 (8 Gb/s).

Installing the M.2_SSD (NGFF) Module

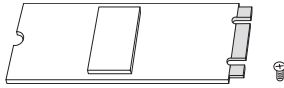

Step 1

Prepare a M.2_SSD (NGFF) module and the screw.

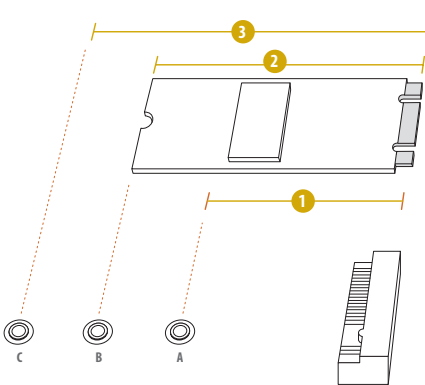

Step 2

Depending on the PCB type and length of your M.2_SSD (NGFF) module, find the corresponding nut location to be used.

No.	1	2	3
Nut Location	A	B	C
PCB Length	4.2cm	8cm	11cm
Module Type	Type 2242	Type 2280	Type 22110

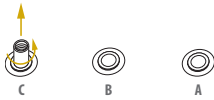
**Step 3**

Move the standoff based on the module type and length. Skip Step 3 and 4 and go straight to Step 5 if you are going to use the default nut. Otherwise, release the standoff by hand.

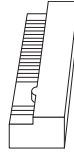
**Step 4**

Peel off the yellow protective film on the nut to be used. Hand tighten the standoff into the desired nut location on the motherboard.

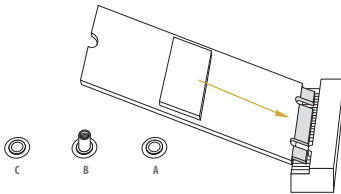
**Step 5**

Align and gently insert the M.2 (NGFF) SSD module into the M.2 slot. Please be aware that the M.2 (NGFF) SSD module only fits in one orientation.

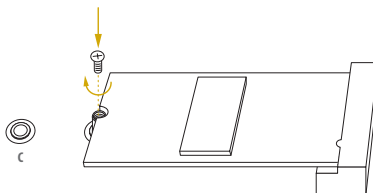
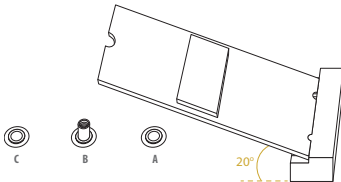
**Step 6**

Tighten the screw with a screwdriver to secure the module into place. Please do not overtighten the screw as this might damage the module.

For the latest updates of M.2_SSD (NFGG) module support list, please visit our website for details: <http://www.asrock.com>

Chapter 3 UEFI Setup Utility

3.1 Introduction

This section explains how to use the UEFI SETUP UTILITY to configure your system. The UEFI chip on the motherboard stores the UEFI SETUP UTILITY. You may run the UEFI SETUP UTILITY when you start up the computer. Please press <F2> or during the Power-On-Self-Test (POST) to enter the UEFI SETUP UTILITY; otherwise, POST will continue with its test routines.

If you wish to enter the UEFI SETUP UTILITY after POST, restart the system by pressing <Ctrl> + <Alt> + <Delete>, or by pressing the reset button on the system chassis. You may also restart by turning the system off and then back on.



Because the UEFI software is constantly being updated, the following UEFI setup screens and descriptions are for reference purpose only, and they may not exactly match what you see on your screen.

3.1.1 UEFI Menu Bar

The top of the screen has a menu bar with the following selections:

Item	Description
Main	To set up the system time/date information
Advanced	To set up the advanced UEFI features
Server Mgmt	To manage the server
Security	To set up the security features
Boot	To set up the default system device to locate and load the Operating System
Event Logs	For event log configuration
Exit	To exit the current screen or the UEFI SETUP UTILITY

Use <←→> key or <→←> key to choose among the selections on the menu bar, and then press <Enter> to get into the sub screen.

3.1.2 Navigation Keys

Please check the following table for the function description of each navigation key.

Navigation Key(s)	Function Description
← / →	Moves cursor left or right to select Screens
↑ / ↓	Moves cursor up or down to select items
+ / -	To change option for the selected items
<Tab>	Switch to next function
<Enter>	To bring up the selected screen
<PGUP>	Go to the previous page
<PGDN>	Go to the next page
<HOME>	Go to the top of the screen
<END>	Go to the bottom of the screen
<F1>	To display the General Help Screen
<F7>	Discard changes and exit the UEFI SETUP UTILITY
<F9>	Load optimal default values for all the settings
<F10>	Save changes and exit the UEFI SETUP UTILITY
<F12>	Print screen
<ESC>	Jump to the Exit Screen or exit the current screen

3.2 Main Screen

Once you enter the UEFI SETUP UTILITY, the Main screen will appear and display the system overview. The Main screen provides system overview information and allows you to set the system time and date.

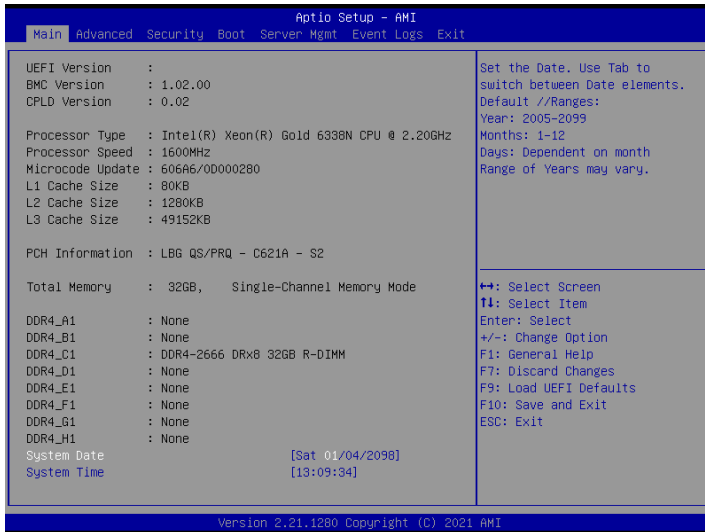

3.3 Advanced Screen

In this section, you may set the configurations for the following items: CPU Configuration, DRAM Configuration, Chipset Configuration, Storage Configuration, ACPI Configuration, USB Configuration, Super IO Configuration, Serial Port Console Redirection, H/W Monitor, Runtime Error Logging, Intel SPS Configuration, Intel(R) VMD Technology, Tls Auth Configuration and Instant Flash.

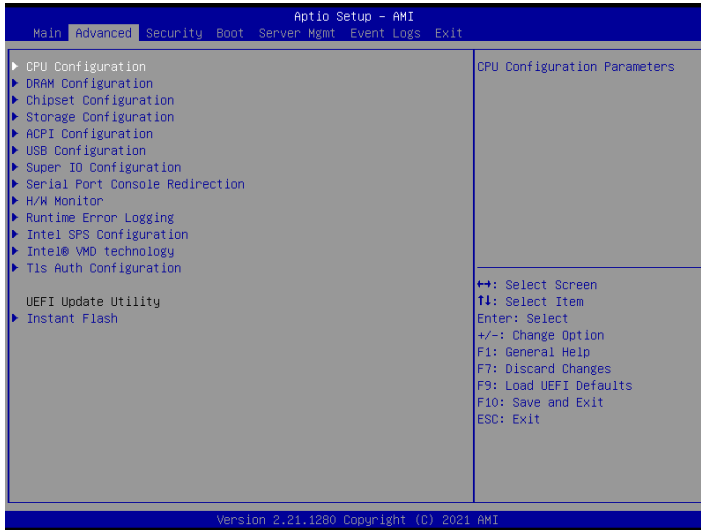

Setting wrong values in this section may cause the system to malfunction.

3.3.1 CPU Configuration

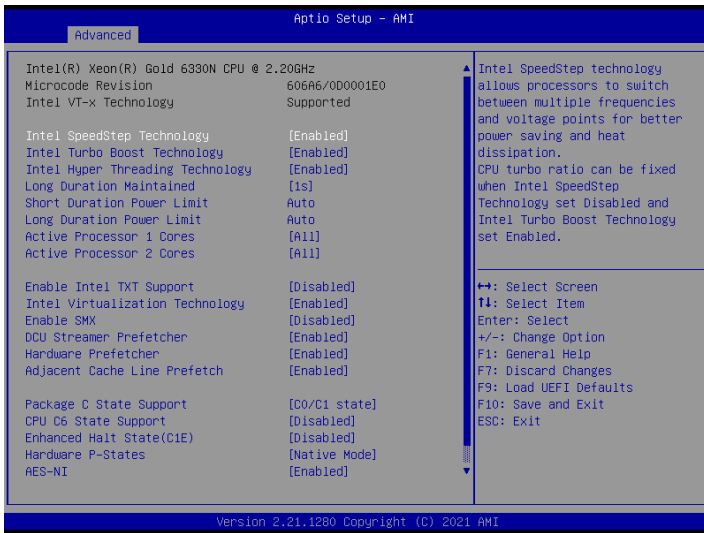

Intel SpeedStep Technology

Intel SpeedStep technology allows processors to switch between multiple frequencies and voltage points for better power saving and heat dissipation. CPU turbo ratio can be fixed when Intel SpeedStep Technology set Disabled and Intel Turbo Boost Technology set Enabled.



Please note that enabling this function may reduce CPU voltage and lead to system stability or compatibility issues with some power supplies. Please set this item to [Disabled] if above issues occur.

Intel Turbo Boost Technology

Intel Turbo Boost Technology enables the processor to run above its base operating frequency when the operating system requests the highest performance state.

Intel Hyper Threading Technology

Intel Hyper Threading Technology allows multiple threads to run on each core, so that the overall performance on threaded software is improved.

Long Duration Maintained

Configure the period of time until the CPU ratio is lowered when the Long Duration Power Limit is exceeded.

Short Duration Power Limit

Configure Package Power Limit 2 in watts. When the limit is exceeded, the CPU ratio will be lowered immediately. A lower limit can protect the CPU and save power, while a higher limit may improve performance.

Long Duration Power Limit

Configure Package Power Limit 1 in watts. When the limit is exceeded, the CPU ratio will be lowered after a period of time. A lower limit can protect the CPU and save power, while a higher limit may improve performance.

Active Processor 1 Cores

Select the number of cores to enable in each processor package.

Enable Intel TXT Support

Enables Intel Trusted Execution Technology Configuration.

Intel Virtualization Technology

Intel Virtualization Technology allows a platform to run multiple operating systems and applications in independent partitions, so that one computer system can function as multiple virtual systems.

Enable SMX

Use this item to enable Safer Mode Extensions.

DCU Streamer Prefetcher

DCU streamer prefetcher is an L1 data cache prefetcher (MSR 1A4h [2]).

Hardware Prefetcher

Automatically prefetch data and code for the processor. Enable for better performance.

Adjacent Cache Line Prefetch

Automatically prefetch the subsequent cache line while retrieving the currently requested cache line. Enable for better performance.

Package C State Support

Enable CPU, PCIe, Memory, Graphics C State Support for power saving.

CPU C6 State Support

Enable C6 deep sleep state for lower power consumption.

Enhanced Halt State(C1E)

Enable Enhanced Halt State (C1E) for lower power consumption.

Hardware P-States

Disable: Hardware chooses a P-state based on OS Request (Legacy P-States)

Native Mode: Hardware chooses a P-state based on OS guidance

Out of Band Mode: Hardware autonomously chooses a P-state (no OS guidance)

AES-NI

Use this item to enable or disable AES-NI support.

CPU Thermal Throttling

Enable CPU internal thermal control mechanisms to keep the CPU from overheating.

SNC (Sub NUMA)

SNC disable will support 1-cluster (XPT/KTI Prefetch enable) 4-IMC way interleave.

SNC2 Enable supports 2-clusters SNC and 2-way IMC interleave. SNC4 Enable supports 4-clusters SNC and 1-way IMC interleave. Enable SNC2 or SNC4 will gray out iMC_ Interleave knob and UmaBasedClustering knob.

Delayed Authentication Mode (DAM) Override

Use this item to enable or disable overriding the state of the Delayed Authentication Mode (DAM).

UMA-Based Clustering

UMA Based Clustering options include Disable (ALL2ALL), Hemisphere (2 cluster), and Quadrant (4 cluster, not supported on ICX). These options are only valid when SNC is disabled. If SNC is enabled, UMA-Based Clustering is automatically disabled by BIOS.

Total Memory Encryption (TME)

Use this item to enable or disable Total Memory Encryption (TME).

SW Guard Extensions (SGX)

Use this item to enable or disable Software Guard Extensions (SGX).

Enable/Disable SGX Auto MP Registration Agent

The MP registration agent is responsible for register the platform.

SGX Registration Server

Use this item to choose which server should be used for SGX registration.

3.3.2 DRAM Configuration

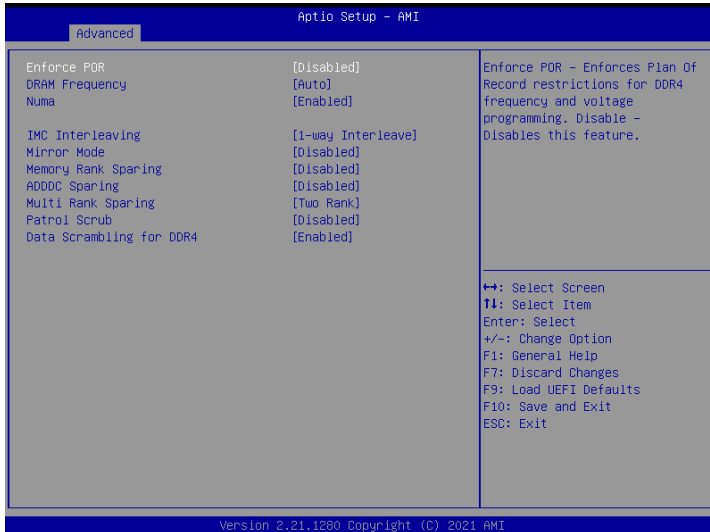

Enforce POR

Enable to enforce POR restrictions for DDR4 frequency and voltage programming.

DRAM Frequency

If [Auto] is selected, the motherboard will detect the memory module(s) inserted and assign the appropriate frequency automatically.

Numa

Use this item to enable or disable Non Uniform Memory Access (NUMA).

IMC Interleaving

Select to configure IMC Interleaving settings.

Mirror Mode

Mirror Mode will set entire 1LM/2LM memory in system to be mirrored, consequently reducing the memory capacity by half. Mirror Enable will disable XPT Prefetch.

Memory Rank Sparing

Enable or disable Memory Rank Sparing.

ADDDC Sparing

Enable or disable Memory Rank Sparing.

Multi Rank Sparing

Set Multi Rank Sparing number. Default and the maximum is 2 ranks per channel.

Patrol Scrub

Patrol Scrub is a background activity initiated by the processor to seek out and fix memory errors. The default value is [Enabled].

Data Scrambling for DDR4

Enable - Enables data scrambling for DDR4.

Disable - Disables this feature.

Auto - Sets it to the MRC default setting; current default is Enable.

3.3.3 Chipset Configuration

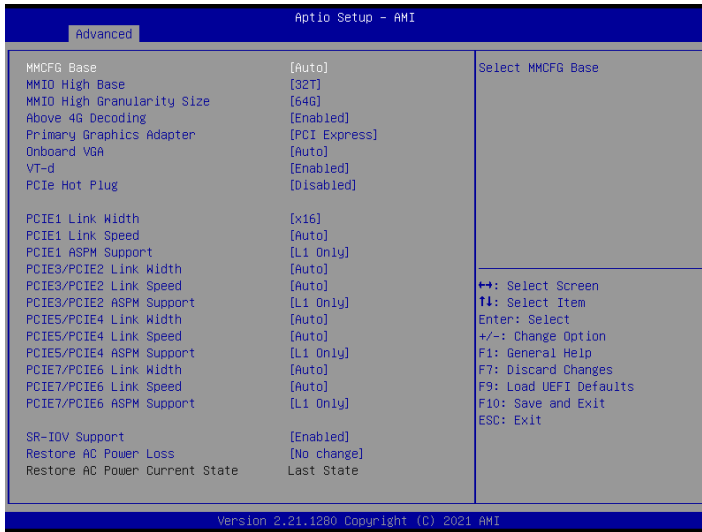

MMCFG Base

Use this item to select MMCFG Base.

MMIO High Base

Use this item to select MMIO High Base.

MMIO High Granularity Size

Use this item to select MMIO Granularity Size.

Above 4G Decoding

Enable or disable 64bit capable Devices to be decoded in Above 4G Address Space (only if the system supports 64 bit PCI decoding).

Primary Graphics Adapter

If PCI Express graphics card is installed on the motherboard, you may use this option to select PCI Express or Onboard VGA as the primary graphics adapter.

**If no PCI Express graphics card is installed, [Onboard VGA] is the default graphics adapter. There is no screen on monitor even if a HDMI display is connected. Select [Onboard Hdmi] instead to use HDMI as output source.*

Onboard VGA

Use this to enable or disable the Onboard VGA function. The default value is [Auto].

**This item is not available when the Primary Graphic Adapter is set to [Onboard VGA] or [Onboard Hdmi] .*

VT-d

Intel Virtualization Technology for Directed I/O helps your virtual machine monitor better utilize hardware by improving application compatibility and reliability, and providing additional levels of manageability, security, isolation, and I/O performance.

PCIe Hot Plug

Use this item to enable or disable PCIe Hot Plug globally.

PCIE1 Link Width

This allows you to select PCIE1 Link Width. The default value is [x16].

PCIE1 Link Speed

This allows you to select PCIE Link Speed. The default value is [Auto].

PCIE1 ASPM Support

This option enables or disables the ASPM support for all CPU downstream devices.

PCIE3/PCIE2 Link Width

This allows you to select PCIE3/PCIE2 Link Width. The default value is [x16].

PCIE3/PCIE2 Link Speed

This allows you to select PCIE Link Speed. The default value is [Auto].

PCIE3/PCIE2 ASPM Support

This option enables or disables the ASPM support for all CPU downstream devices.

PCIE5/PCIE4 Link Width

This allows you to select PCIE5/PCIE4 Link Width. The default value is [x16].

PCIE5/PCIE4 Link Speed

This allows you to select PCIE Link Speed. The default value is [Auto].

PCIE5/PCIE4 ASPM Support

This option enables or disables the ASPM support for all CPU downstream devices.

PCIE7/PCIE6 Link Width

This allows you to select PCIE7/PCIE6 Link Width. The default value is [x16].

PCIE7/PCIE6 Link Speed

This allows you to select PCIE Link Speed. The default value is [Auto].

PCIE7/PCIE6 ASPM Support

This option enables or disables the ASPM support for all CPU downstream devices.

SR-IOV Support

If system has SR-IOV capable PCIe Devices, this option Enables or Disables Single Root IO Virtualization Support.

Restore AC Power Loss

Select the power state after a power failure. If [Power Off] is selected, the power will remain off when the power recovers. If [Power On] is selected, the system will start to boot up when the power recovers.

Restore AC Power Current State

This allows you to restore AC Power Current State

3.3.4 Storage Configuration

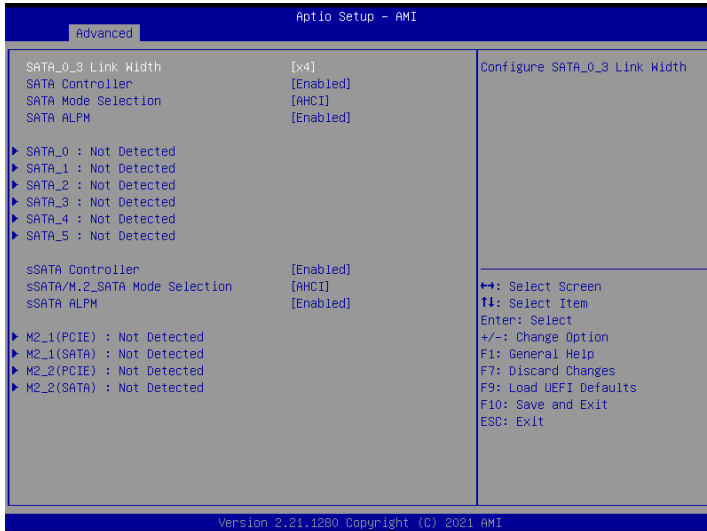

SATA Controller

Use this item to enable or disable SATA Controllers.

SATA Mode Selection

Identify the SATA port is connected to Solid State Drive or Hard Disk Drive. Press <Ctrl+I> to enter RAID ROM during UEFI POST process.

SATA ALPM

Use this item to enable or disable Aggressive Link Power Management.

sSATA Controller

Use this item to enable or disable SATA Controllers.

sSATA/M.2_SATA Mode Selection

Identify the SATA/M.2_SATA port is connected to Solid State Drive or Hard Disk Drive. Press <Ctrl+I> to enter RAID ROM during UEFI POST process.

sSATA ALPM

Use this item to enable or disable Aggressive Link Power Management.

3.3.5 ACPI Configuration

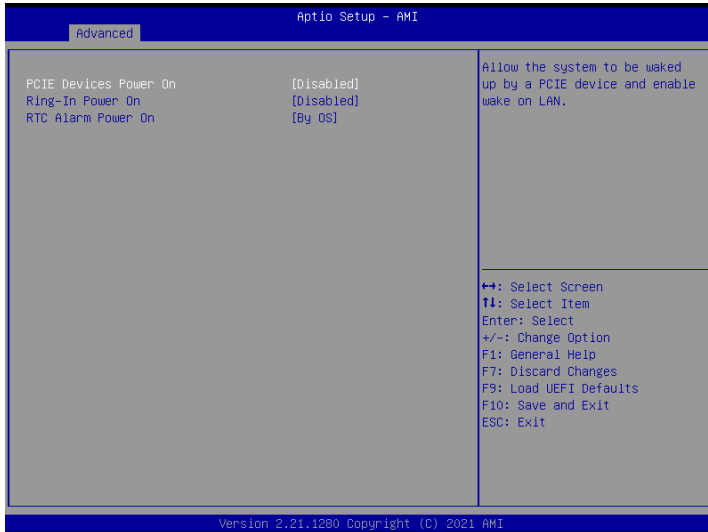

PCIE Devices Power On

Allow the system to be waked up by a PCIE device and enable wake on LAN.

Ring-In Power On

Use this item to enable or disable Ring-In signals to turn on the system from the power-soft-off mode.

RTC Alarm Power On

Use this item to enable or disable RTC (Real Time Clock) to power on the system.

3.3.6 USB Configuration



Legacy USB Support

Use this option to enable or disable legacy support for USB devices. The default value is [Enabled].

3.3.7 Super IO Configuration

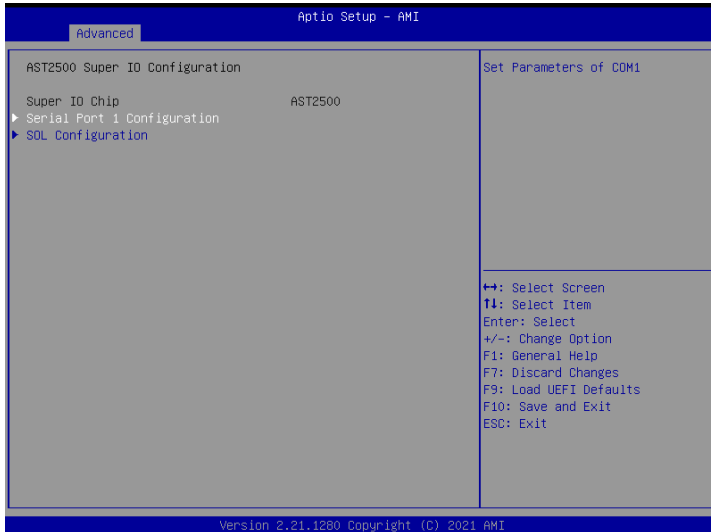

Serial Port 1 Configuration

Use this item to set parameters of Serial Port 1 (COM1).

Serial Port

Use this item to enable or disable the serial port.

Change Settings

Use this item to select an optimal setting for Super IO device.

SOL Configuration

Use this item to set parameters of SOL.

SOL Port

Use this item to set parameters of SOL.

Change Settings

Use this item to select an optimal setting for Super IO device.

3.3.8 Serial Port Console Redirection

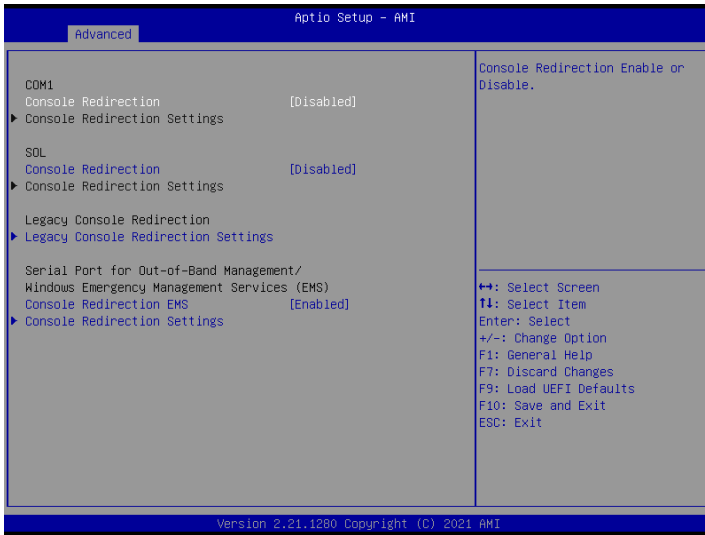

COM1 / SOL

Console Redirection

Use this option to enable or disable Console Redirection. If this item is set to Enabled, you can select a COM Port to be used for Console Redirection.

Console Redirection Settings

Use this option to configure Console Redirection Settings, and specify how your computer and the host computer to which you are connected exchange information. Both computers should have the same or compatible settings.

Terminal Type

Use this item to select the preferred terminal emulation type for out-of-band management. It is recommended to select [VT-UTF8].

Option	Description
VT100	ASCII character set
VT100+	Extended VT100 that supports color and function keys
VT-UTF8	UTF8 encoding is used to map Unicode chars onto 1 or more bytes
ANSI	Extended ASCII character set

Bits Per Second

Use this item to select the serial port transmission speed. The speed used in the host computer and the client computer must be the same. Long or noisy lines may require lower transmission speed. The options include [9600], [19200], [38400], [57600] and [115200].

Data Bits

Use this item to set the data transmission size. The options include [7] and [8] (Bits).

Parity

Use this item to select the parity bit. The options include [None], [Even], [Odd], [Mark] and [Space].

Stop Bits

The item indicates the end of a serial data packet. The standard setting is [1] Stop Bit. Select [2] Stop Bits for slower devices.

Flow Control

Use this item to set the flow control to prevent data loss from buffer overflow. When sending data, if the receiving buffers are full, a "stop" signal can be sent to stop the data flow. Once the buffers are empty, a "start" signal can be sent to restart the flow. Hardware flow uses two wires to send start/stop signals. The options include [None] and [Hardware RTS/CTS].

VT-UTF8 Combo Key Support

Use this item to enable or disable the VT-UTF8 Combo Key Support for ANSI/VT100 terminals.

Recorder Mode

Use this item to enable or disable Recorder Mode to capture terminal data and send it as text messages.

Resolution 100x31

Use this item to enable or disable extended terminal resolution support.

Putty Keypad

Use this item to select Function Key and Keypad on Putty.

Legacy Console Redirection**Legacy Console Redirection Settings**

Use this option to configure Legacy Console Redirection Settings, and specify how your computer and the host computer to which you are connected exchange information.

Redirection COM Port

Select a COM port to display redirection of Legacy OS and Legacy OPROM Messages.

Resolution

On Legacy OS, the Number of Rows and Columns supported redirection.

Redirect After POST

When Bootloader is selected, then Legacy Console Redirection is disabled before booting to legacy OS. When Always Enable is selected, then Legacy Console Redirection is enabled for legacy OS. Default setting for this option is set to Always Enable.

Serial Port for Out-of-Band Management/Windows Emergency Management Services (EMS)

Console Redirection

Use this option to enable or disable Console Redirection. If this item is set to Enabled, you can select a COM Port to be used for Console Redirection.

Console Redirection Settings

Use this option to configure Console Redirection Settings, and specify how your computer and the host computer to which you are connected exchange information.

Out-of-Band Mgmt Port

Microsoft Windows Emergency Management Services (EMS) allows for remote management of a Windows Server OS through a serial port.

Terminal Type EMS

Use this item to select the preferred terminal emulation type for out-of-band management. It is recommended to select [VT-UTF8].

Option	Description
VT100	ASCII character set
VT100+	Extended VT100 that supports color and function keys
VT-UTF8	UTF8 encoding is used to map Unicode chars onto 1 or more bytes
ANSI	Extended ASCII character set

Bits Per Second EMS

Use this item to select the serial port transmission speed. The speed used in the host computer and the client computer must be the same. Long or noisy lines may require lower transmission speed. The options include [9600], [19200], [57600] and [115200].

Flow Control EMS

Use this item to set the flow control to prevent data loss from buffer overflow. When sending data, if the receiving buffers are full, a "stop" signal can be sent to stop the data flow. Once the buffers are empty, a "start" signal can be sent to restart the flow. Hardware flow uses two wires to send start/stop signals. The options include [None], [Hardware RTS/CTS], and [Software Xon/Xoff].

Data Bits EMS

Parity EMS

Stop Bits EMS

3.3.9 H/W Monitor

In this section, it allows you to monitor the status of the hardware on your system, including the parameters of the CPU temperature, motherboard temperature, CPU fan speed, chassis fan speed, and the critical voltage.

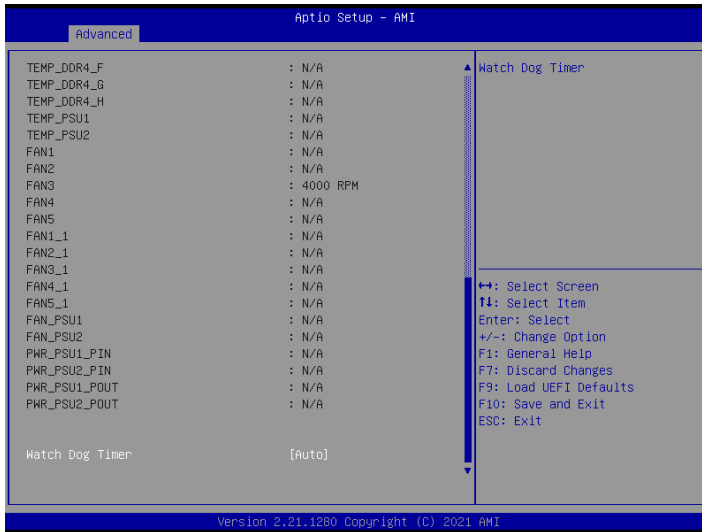

Watch Dog Timer

This allows you to enable or disable the Watch Dog Timer. The default value is [Auto].

3.3.10 Runtime Error Logging

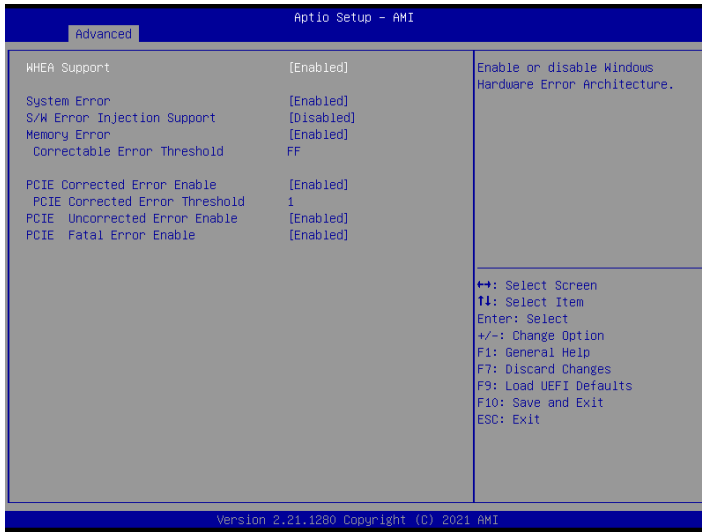

WHEA Support

Use this item to enable or disable Windows Hardware Error Architecture.

System Error

Use this item to enable or disable System Error feature. When it is set to [Enabled], you can configure Memory Error and PCIe Error log features.

S/W Error Injection Support

When it is set to [Enabled], S/W Error Injection is supported by unlocking MSR 0x790.

Memory Error

Memory enabling and logging setup option.

Correctable Error Threshold

Correctable Error Threshold (0 - 0x7FFF) used for sparing, tagging, and leaky bucket.

PCIe Corrected Error Enable

Use this item to enable or disable PCIe Correctable errors.

PCIe Corrected Error Threshold

PCIe Correctable Error Threshold (0x01-0xFF) used for sparing, tagging, and leaky bucket.

PCIe Uncorrected Error Enable

Use this item to enable or disable PCIe Uncorrectable errors.

PCIe Fatal Error Enable

Use this item to enable or disable PCIe Fatal errors.

3.3.11 Intel SPS Configuration

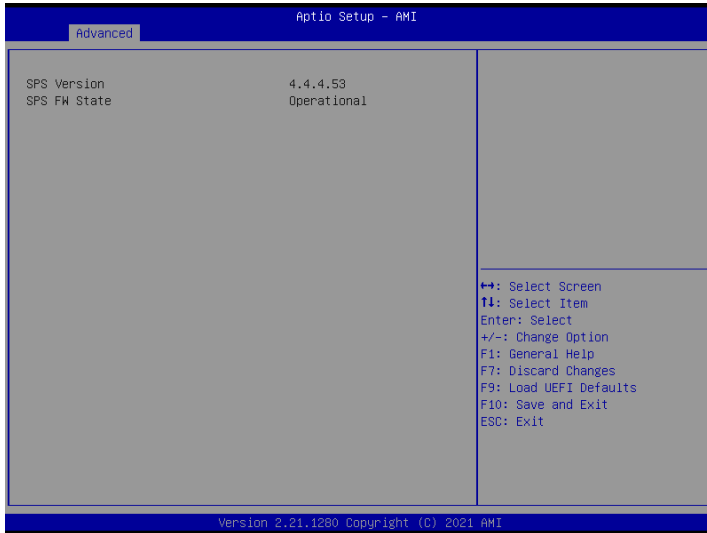

SPS screen displays the Intel SPS Configuration information, such as Operational Firmware Version and Firmware State.

3.3.12 Intel® VMD technology

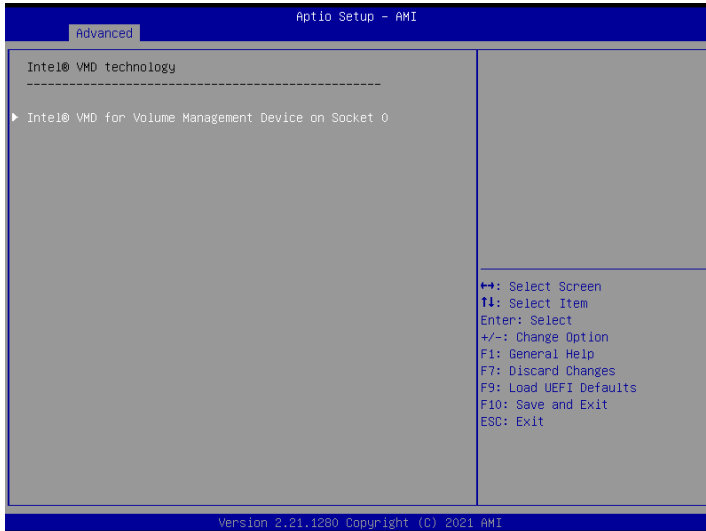

Press <Enter> to bring up the Intel(R) VMD for Volume Management Device Configuration menu.

Intel(R) VMD for Volume Management Device on Socket 0

Intel(R) VMD for Volume Management Device Technology

Use this item to enable or disable Intel(R) Volume Management Device Technology in this Stack.

When [Enabled], users are allowed to configure the options below.

VMD port 1A

Use this item to enable or disable Intel(R) Volume Management Device Technology on specific root port.

VMD port 1C

Use this item to enable or disable Intel(R) Volume Management Device Technology on specific root port.

VMD port 1D

Use this item to enable or disable Intel(R) Volume Management Device Technology on specific root port.

Hot Plug Capable

Enable/Disable Hot Plug for PCIe Root Ports 1A-1D.

Intel(R) VMD for Volume Management Device Technology

Use this item to enable or disable Intel(R) Volume Management Device Technology in this Stack.

When [Enabled], users are allowed to configure the options below.

VMD port 2A

Use this item to enable or disable Intel(R) Volume Management Device Technology on specific root port.

VMD port 2B

Use this item to enable or disable Intel(R) Volume Management Device Technology on specific root port.

VMD port 2C

Use this item to enable or disable Intel(R) Volume Management Device Technology on specific root port.

VMD port 2D

Use this item to enable or disable Intel(R) Volume Management Device Technology on specific root port.

Hot Plug Capable

Enable/Disable Hot Plug for PCIe Root Ports 2A-2D.

Intel(R) VMD for Volume Management Device Technology

Use this item to enable or disable Intel(R) Volume Management Device Technology in this Stack.

When [Enabled], users are allowed to configure the options below.

VMD port 3A

Use this item to enable or disable Intel(R) Volume Management Device Technology on specific root port.

VMD port 3B

Use this item to enable or disable Intel(R) Volume Management Device Technology on specific root port.

VMD port 3C

Use this item to enable or disable Intel(R) Volume Management Device Technology on specific root port.

VMD port 3D

Use this item to enable or disable Intel(R) Volume Management Device Technology on specific root port.

Hot Plug Capable

Use this item to enable or disable Hot Plug for PCIe Root Ports 3A-3D.

Intel(R) VMD for Volume Management Device Technology

Use this item to enable or disable Intel(R) Volume Management Device Technology in this Stack.

When [Enabled], users are allowed to configure the options below.

VMD port 4A

Use this item to enable or disable Intel(R) Volume Management Device Technology on specific root port.

VMD port 4B

Use this item to enable or disable Intel(R) Volume Management Device Technology on specific root port.

VMD port 4C

Use this item to enable or disable Intel(R) Volume Management Device Technology on specific root port.

VMD port 4D

Use this item to enable or disable Intel(R) Volume Management Device Technology on specific root port.

Hot Plug Capable

Use this item to enable or disable Hot Plug for PCIe Root Ports 4A-4D.

3.3.13 Tls Auth Configuration

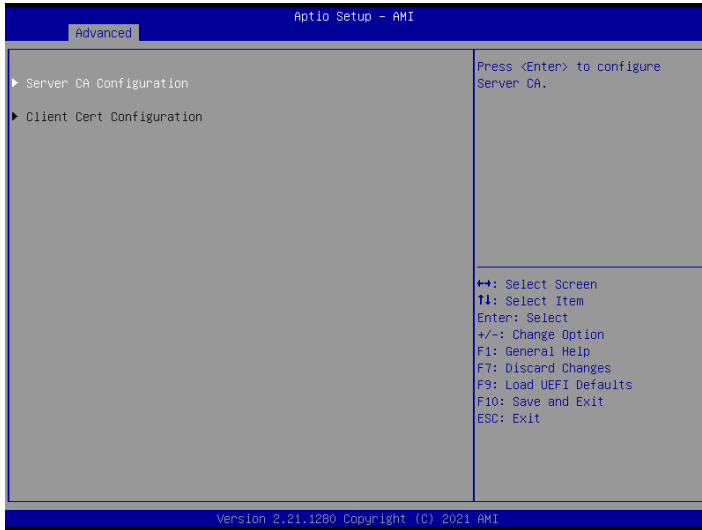

Server CA Configuration

Press <Enter> to configure Server CA.

Client Cert Configuration

Press <Enter> to configure Client Cert.

3.3.14 Instant Flash

Instant Flash is a UEFI flash utility embedded in Flash ROM. This convenient UEFI update tool allows you to update system UEFI without entering operating systems first like MS-DOS or Windows[®]. Just save the new UEFI file to your USB flash drive, floppy disk or hard drive and launch this tool, then you can update your UEFI only in a few clicks without preparing an additional floppy diskette or other complicated flash utility. Please be noted that the USB flash drive or hard drive must use FAT32/16/12 file system. If you execute Instant Flash utility, the utility will show the UEFI files and their respective information. Select the proper UEFI file to update your UEFI, and reboot your system after the UEFI update process is completed.

3.4 Security

In this section, you may set or change the supervisor/user password for the system. For the user password, you may also clear it.



Supervisor Password

Set or change the password for the administrator account. Only the administrator has authority to change the settings in the UEFI Setup Utility. Leave it blank and press enter to remove the password.

User Password

Set or change the password for the user account. Users are unable to change the settings in the UEFI Setup Utility. Leave it blank and press enter to remove the password.

Secure Boot

Use this to enable or disable Secure Boot Control. The default value is [Disabled]. Enable to support Windows Server 2012 R2 or later versions Secure Boot.

Secure Boot Mode

Secure Boot mode selector: Standard/Custom. In Custom mode Secure Boot Variables can be configured without authentication.

3.4.1 Key Management

In this section, expert users can modify Secure Boot Policy variables without full authentication.

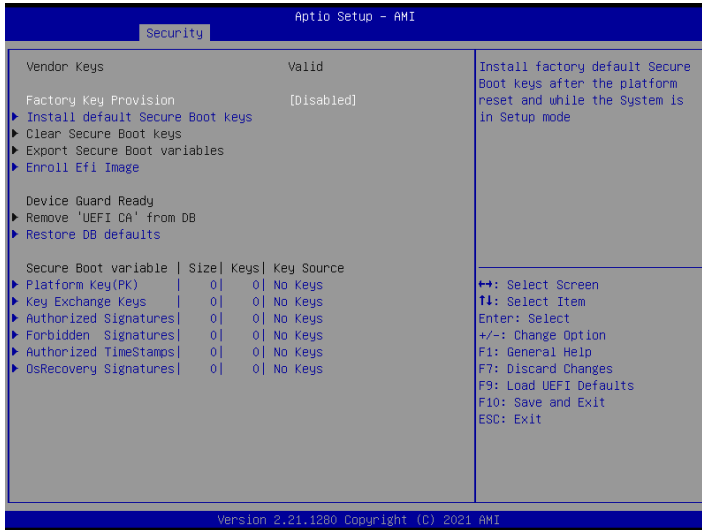

Factory Key Provision

Install factory default Secure Boot keys after the platform reset and while the System is in Setup mode.

Install Default Secure Boot Keys

Please install default secure boot keys if it's the first time you use secure boot.

Enroll Efi Image

Allow the image to run in Secure Boot mode. Enroll SHA256 hash of the binary into Authorized Signature Database (db).

Restore DB defaults

Restore DB variable to factory defaults.

Platform Key(PK)

Enroll Factory Defaults or load certificates from a file:

1. Public Key Certificate in:

a) EFI_SIGNATURE_LIST

- b) EFI_CERT_X509 (DER)
 - c) EFI_CERT_RSA2048 (bin)
 - d) EFI_CERT_SHAXXX
2. Authenticated UEFI Variable
 3. EFI PE/COFF Image(SHA256)

Key Source: Default, External, Mixed

Key Exchange Keys

Enroll Factory Defaults or load certificates from a file:

1. Public Key Certificate in:
 - a) EFI_SIGNATURE_LIST
 - b) EFI_CERT_X509 (DER)
 - c) EFI_CERT_RSA2048 (bin)
 - d) EFI_CERT_SHAXXX
2. Authenticated UEFI Variable
3. EFI PE/COFF Image(SHA256)

Key Source: Default, External, Mixed

Key Source: Default, External, Mixed, Test

Authorized Signatures

Enroll Factory Defaults or load certificates from a file:

1. Public Key Certificate in:
 - a) EFI_SIGNATURE_LIST
 - b) EFI_CERT_X509 (DER)
 - c) EFI_CERT_RSA2048 (bin)
 - d) EFI_CERT_SHAXXX
2. Authenticated UEFI Variable
3. EFI PE/COFF Image(SHA256)

Key Source: Default, External, Mixed

Forbidden Signatures

Enroll Factory Defaults or load certificates from a file:

1. Public Key Certificate in:

- a) EFI_SIGNATURE_LIST
- b) EFI_CERT_X509 (DER)
- c) EFI_CERT_RSA2048 (bin)
- d) EFI_CERT_SHAXXX

2. Authenticated UEFI Variable

3. EFI PE/COFF Image(SHA256)

Key Source: Default, External, Mixed

Authorized TimeStamps

Enroll Factory Defaults or load certificates from a file:

1. Public Key Certificate in:

- a) EFI_SIGNATURE_LIST
- b) EFI_CERT_X509 (DER)
- c) EFI_CERT_RSA2048 (bin)
- d) EFI_CERT_SHAXXX

2. Authenticated UEFI Variable

3. EFI PE/COFF Image(SHA256)

Key Source: Default, External, Mixed

OsRecovery Signatures

Enroll Factory Defaults or load certificates from a file:

1. Public Key Certificate in:

- a) EFI_SIGNATURE_LIST
- b) EFI_CERT_X509 (DER)
- c) EFI_CERT_RSA2048 (bin)
- d) EFI_CERT_SHAXXX

2. Authenticated UEFI Variable

3. EFI PE/COFF Image(SHA256)

Key Source: Default, External, Mixed

3.5 Boot Screen

In this section, it will display the available devices on your system for you to configure the boot settings and the boot priority.

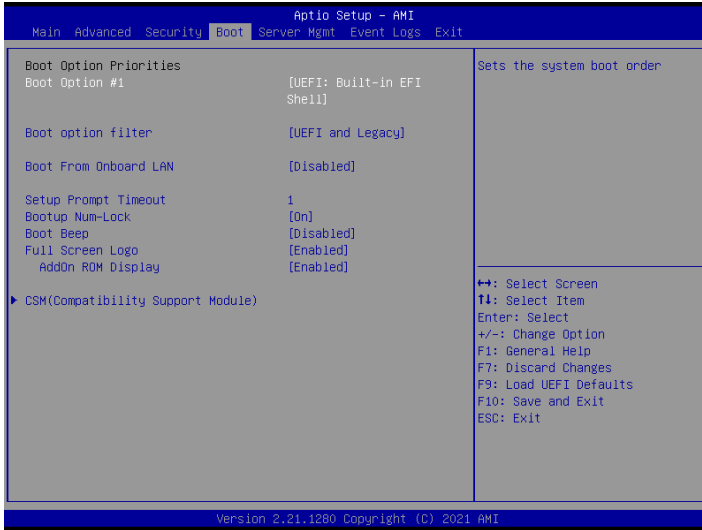

Boot Option #1

Use this item to set the system boot order.

Boot Option Filter

This option controls Legacy/UEFI ROMs priority.

Boot From Onboard LAN

Use this item to enable or disable the Boot From Onboard LAN feature.

Setup Prompt Timeout

Configure the number of seconds to wait for the UEFI setup utility.

Bootup Num-Lock

If this item is set to [On], it will automatically activate the Numeric Lock function after boot-up.

Boot Beep

Select whether the Boot Beep should be turned on or off when the system boots up. Please note that a buzzer is needed.

Full Screen Logo

Use this item to enable or disable OEM Logo. The default value is [Enabled].

AddOn ROM Display

Use this option to adjust AddOn ROM Display. If you enable the option “Full Screen Logo” but you want to see the AddOn ROM information when the system boots, please select [Enabled]. Configuration options: [Enabled] and [Disabled]. The default value is [Enabled].

3.5.1 CSM Parameters

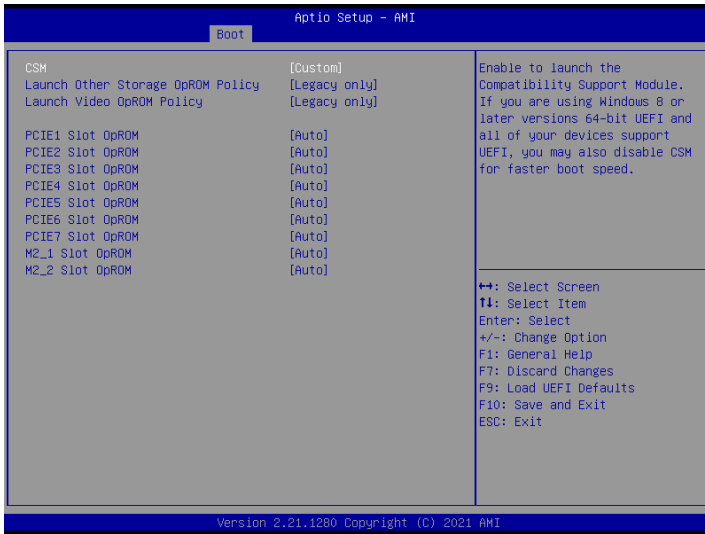

CSM

Enable to launch the Compatibility Support Module. Please do not disable unless you're running a WHCK test. If you are using Windows 10 64-bit and all of your devices support UEFI, you may also disable CSM for faster boot speed.

Launch Other Storage OpROM Policy

Select UEFI only to run those that support UEFI option ROM only. Select Legacy only to run those that support legacy option ROM only. Select Do not launch to not execute both legacy and UEFI option ROM.

Launch Video OpROM Policy

Select UEFI only to run those that support UEFI option ROM only. Select Legacy only to run those that support legacy option ROM only. Select Do not launch to not execute both legacy and UEFI option ROM.

PCIE1 Slot OpROM

Use this item to select slot storage and Network Option ROM policy. In Auto option, the default is Disabled with NVMe device, but it is Legacy with other devices. (This item can't select Video Option ROM policy.)

PCIE2 Slot OpROM

Use this item to select slot storage and Network Option ROM policy. In Auto option, the default is Disabled with NVMe device, but it is Legacy with other devices. (This item can't select Video Option ROM policy.)

SLIM3 Slot OpROM

Use this item to select slot storage and Network Option ROM policy. In Auto option, the default is Disabled with NVMe device, but it is Legacy with other devices. (This item can't select Video Option ROM policy.)

SLIM4 Slot OpROM

Use this item to select slot storage and Network Option ROM policy. In Auto option, the default is Disabled with NVMe device, but it is Legacy with other devices. (This item can't select Video Option ROM policy.)

SLIM5 Slot OpROM

Use this item to select slot storage and Network Option ROM policy. In Auto option, the default is Disabled with NVMe device, but it is Legacy with other devices. (This item can't select Video Option ROM policy.)

PCIE6 Slot OpROM

Use this item to select slot storage and Network Option ROM policy. In Auto option, the default is Disabled with NVMe device, but it is Legacy with other devices. (This item can't select Video Option ROM policy.)

PCIE7 Slot OpROM

Use this item to select slot storage and Network Option ROM policy. In Auto option, the default is Disabled with NVMe device, but it is Legacy with other devices. (This item can't select Video Option ROM policy.)

M2_1 Slot OpROM

Use this item to select slot storage and Network Option ROM policy. In Auto option, the default is Disabled with NVMe device, but it is Legacy with other devices. (This item can't select Video Option ROM policy.)

M2_2 Slot OpROM

Use this item to select slot storage and Network Option ROM policy. In Auto option, the default is Disabled with NVMe device, but it is Legacy with other devices. (This item can't select Video Option ROM policy.)

3.6 Server Mgmt



Wait For BMC

Wait For BMC response for specified time out. BMC starts at the same time when BIOS starts during AC power ON. It takes around 90 seconds to initialize Host to BMC interfaces.

3.6.1 System Event Log

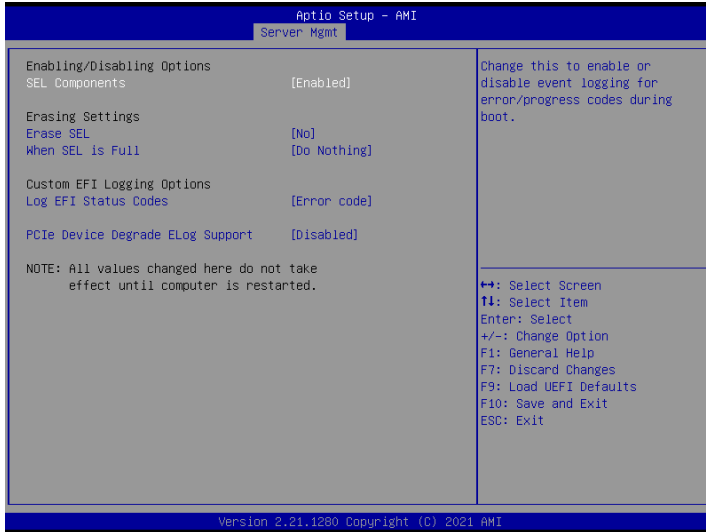

SEL Components

Change this to enable or disable event logging for error/progress codes during boot.

Erase SEL

Use this to choose options for erasing SEL.

When SEL is Full

Use this to choose options for reactions to a full SEL.

Log EFI Status Codes

Use this item to disable the logging of EFI Status Codes or log only error code or only progress code or both.

PCIe Device Degrade ELog Support

Use this item to enable or disable PCIe Device Degrade Error Logging Support.

3.6.2 View System Event Log

Press <Enter> to view the System Event Log Records.

3.6.3 BMC Network Configuration

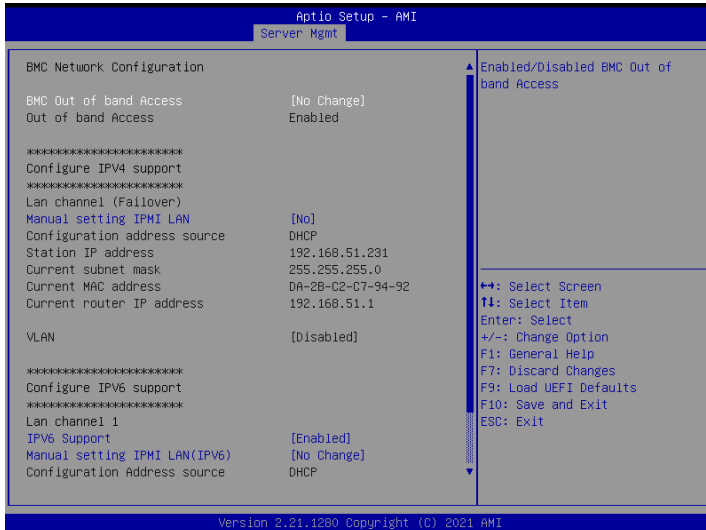

BMC Out of Band Access

Enabled/Disabled BMC Out of band Access.

Lan Channel (Failover)

Manual Setting IPMI LAN

If [No] is selected, the IP address is assigned by DHCP. If you prefer using a static IP address, toggle to [Yes], and the changes take effect after the system reboots. The default value is [No].

Configuration Address Source

Select to configure BMC network parameters statically or dynamically (by BIOS or BMC). Configuration options: [Static] and [DHCP].

Static: Manually enter the IP Address, Subnet Mask and Gateway Address in the BIOS for BMC LAN channel configuration.

DHCP: IP address, Subnet Mask and Gateway Address are automatically assigned by the network's DHCP server.



When [DHCP] or [Static] is selected, do NOT modify the BMC network settings on the IPMI web page.



The default login information for the IPMI web interface is:

Username: admin

Password: admin

For more instructions on how to set up remote control environment and use the IPMI management platform, please refer to the IPMI Configuration User Guide or go to the Support website at: <http://www.asrockrack.com/support/ipmi.asp>

VLAN

IPV6 Support

Enable or Disable LAN1 IPV6 Support.

Manual Setting IPMI LAN(IPV6)

Select to configure LAN channel parameters statically or dynamically(by BIOS or BMC).

Unspecified option will not modify any BMC network parameters during BIOS phase.

3.6.4 BMC Tools

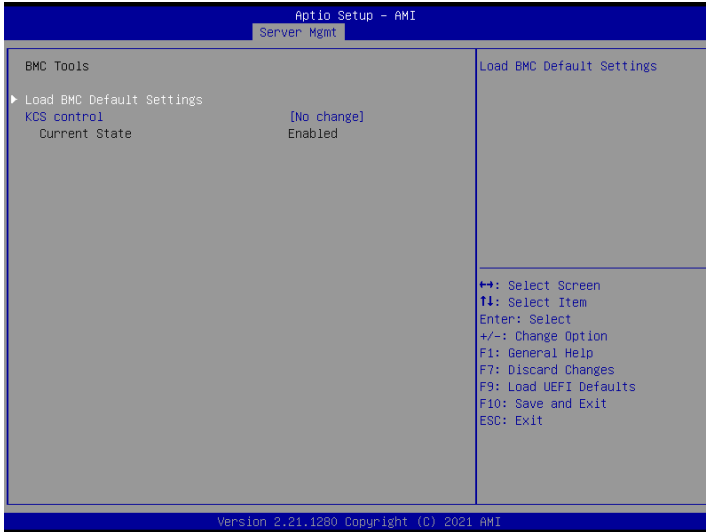

Load BMC Default Settings

Use this item to load BMC default settings.

KCS control

Select the KSC interface state after POST end. If [Enabled] is selected, the BMC will remain KCS interface after POST stage. If [Disabled] is selected, the BMC will disable KCS interface after POST stage.

3.7 Event Logs

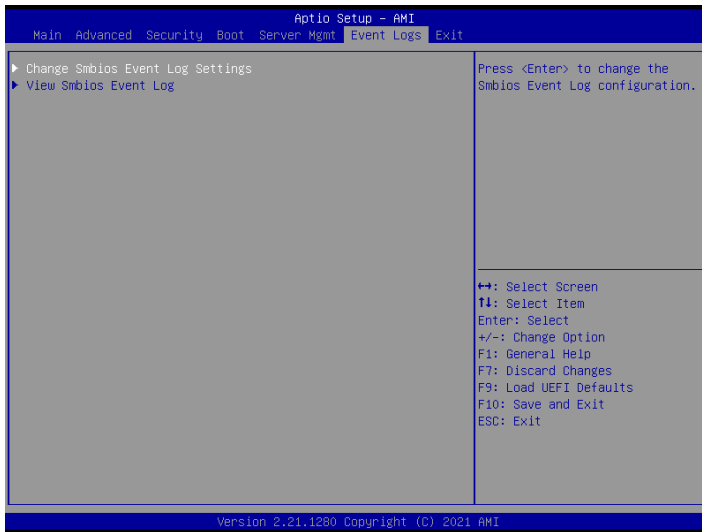

Change Smbios Event Log Settings

This allows you to configure the Smbios Event Log Settings.

When entering the item, you will see the followings:

Smbios Event Log

Use this item to enable or disable all features of the SMBIOS Event Logging during system boot.

Erase Event Log

The options include [No], [Yes, Next reset] and [Yes, Every reset]. If Yes is selected, all logged events will be erased.

When Log is Full

Use this item to choose options for reactions to a full Smbios Event Log. The options include [Do Nothing] and [Erase Immediately].

Log System Boot Event

Choose option to enable/disable logging of System boot event.

View Smbios Event Log

Press <Enter> to view the Smbios Event Log records.



All values changed here do not take effect until computer is restarted.

3.8 Exit Screen

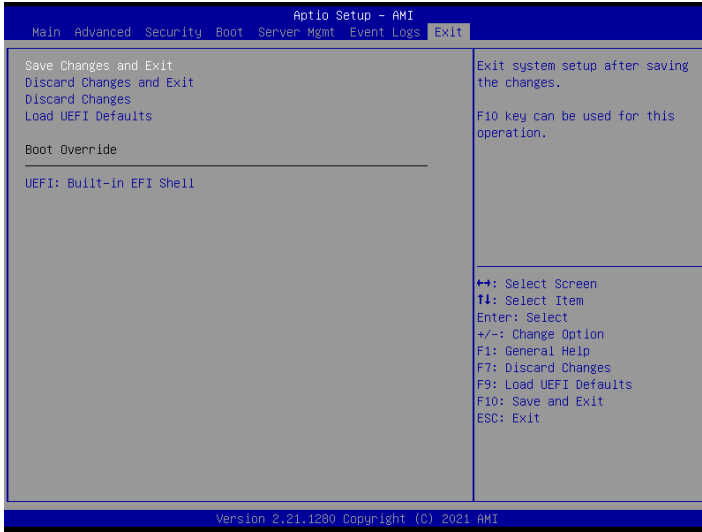

Save Changes and Exit

When you select this option, the following message “Save configuration changes and exit setup?” will pop-out. Press <F10> key or select [Yes] to save the changes and exit the UEFI SETUP UTILITY.

Discard Changes and Exit

When you select this option, the following message “Discard changes and exit setup?” will pop-out. Press <ESC> key or select [Yes] to exit the UEFI SETUP UTILITY without saving any changes.

Discard Changes

When you select this option, the following message “Discard changes?” will pop-out. Press <F7> key or select [Yes] to discard all changes.

Load UEFI Defaults

Load UEFI default values for all the setup questions. F9 key can be used for this operation.

Chapter 4 Software Support

4.1 Install Operating System

This motherboard supports various Microsoft® Windows® / Linux® compliant. Because motherboard settings and hardware options vary, use the setup procedures in this chapter for general reference only. Refer to your OS documentation for more information.

**Please download the Intel® SATA Floppy Image driver from the ASRock Rack's website (www.asrockrack.com) to your USB drive or simply install the SATA driver from the Support CD while installing OS in SATA RAID mode.*

** Before installing the Linux OS, please first enter the BIOS settings, go to "Advanced" > "Chipset Configuration" and set "IGPU Multi-Monitor" option to "Disabled".*

4.2 Support CD Information

The Support CD that came with the motherboard contains necessary drivers and useful utilities that enhance the motherboard's features.

4.2.1 Running The Support CD

To begin using the support CD, insert the CD into your CD-ROM drive. The CD automatically displays the Main Menu if "AUTORUN" is enabled in your computer. If the Main Menu does not appear automatically, locate and double click on the file "ASRSetup.exe" from the root folder in the Support CD to display the menu.

4.2.2 Drivers Menu

The Drivers Menu shows the available device's drivers if the system detects installed devices. Please install the necessary drivers to activate the devices.

4.2.3 Utilities Menu

The Utilities Menu shows the application softwares that the motherboard supports. Click on a specific item then follow the installation wizard to install it.

4.2.4 Contact Information

If you need to contact ASRock Rack or want to know more about ASRock Rack, welcome to visit ASRock Rack's website at <http://www.ASRockRack.com>; or you may contact your dealer for further information.

Chapter 5 Troubleshooting

5.1 Troubleshooting Procedures

Follow the procedures below to troubleshoot your system.



Always unplug the power cord before adding, removing or changing any hardware components. Failure to do so may cause physical injuries to you and damages to motherboard components.

1. Disconnect the power cable and check whether the PWR LED is off.
2. Unplug all cables, connectors and remove all add-on cards from the motherboard. Make sure that the jumpers are set to default settings.
3. Confirm that there are no short circuits between the motherboard and the chassis.
4. Install a CPU and fan on the motherboard, then connect the chassis speaker and power LED.

If there is no power...

1. Confirm that there are no short circuits between the motherboard and the chassis.
2. Make sure that the jumpers are set to default settings.
3. Check the settings of the 115V/230V switch on the power supply.
4. Verify if the battery on the motherboard provides ~3VDC. Install a new battery if it does not.

If there is no video...

1. Try replugging the monitor cables and power cord.
2. Check for memory errors.

If there are memory errors...

1. Verify that the DIMM modules are properly seated in the slots.
2. Use recommended DDR4 RDIMM/RDIMM-3DS/LRDIMM/LRDIMM-3DS/ Intel®Optane™ Persistent Memory 200 Series.
3. If you have installed more than one DIMM modules, they should be identical with the same brand, speed, size and chip-type.
4. Try inserting different DIMM modules into different slots to identify faulty ones.

5. Check the settings of the 115V/230V switch on the power supply.

Unable to save system setup configurations...

1. Verify if the battery on the motherboard provides ~3VDC. Install a new battery if it does not.
2. Confirm whether your power supply provides adequate and stable power.

Other problems...

1. Try searching keywords related to your problem on ASRock Rack's FAQ page:
<http://www.asrockrack.com/support>

5.2 Technical Support Procedures

If you have tried the troubleshooting procedures mentioned above and the problems are still unsolved, please contact ASRock Rack's technical support with the following information:

1. Your contact information
2. Model name, BIOS version and problem type.
3. System configuration.
4. Problem description.

You may contact ASRock Rack's technical support at:

<http://www.asrockrack.com/support/tsd.asp>

5.3 Returning Merchandise for Service

For warranty service, the receipt or a copy of your invoice marked with the date of purchase is required. By calling your vendor or going to our RMA website (<http://event.asrockrack.com/tsd.asp>) you may obtain a Returned Merchandise Authorization (RMA) number.

The RMA number should be displayed on the outside of the shipping carton which is mailed prepaid or hand-carried when you return the motherboard to the manufacturer. Shipping and handling charges will be applied for all orders that must be mailed when service is complete.

This warranty does not cover damages incurred in shipping or from failure due to alteration, misuse, abuse or improper maintenance of products.

Contact your distributor first for any product related problems during the warranty period.

Contact Information

If you need to contact ASRock or want to know more about ASRock, you're welcome to visit ASRock's website at <http://www.asrock.com>; or you may contact your dealer for further information. For technical questions, please submit a support request form at <https://event.asrock.com/tsd.asp>

ASRock Incorporation

2F., No.37, Sec. 2, Jhongyang S. Rd., Beitou District,

Taipei City 112, Taiwan (R.O.C.)

ASRock EUROPE B.V.

Bijsterhuizen 11-11

6546 AR Nijmegen

The Netherlands

Phone: +31-24-345-44-33

Fax: +31-24-345-44-38

ASRock America, Inc.

13848 Magnolia Ave, Chino, CA91710

U.S.A.

Phone: +1-909-590-8308

Fax: +1-909-590-1026

DECLARATION OF CONFORMITY

Per FCC Part 2 Section 2.1077(a)



Responsible Party Name: ASRock Incorporation

Address: 13848 Magnolia Ave, Chino, CA91710

Phone/Fax No: +1-909-590-8308/+1-909-590-1026

hereby declares that the product

Product Name : Motherboard

Model Number : C621A WS

Conforms to the following specifications:

FCC Part 15, Subpart B, Unintentional Radiators

Supplementary Information:

This device complies with part 15 of the FCC Rules. Operation is subject to the following two conditions: (1) This device may not cause harmful interference, and (2) this device must accept any interference received, including interference that may cause undesired operation.

Representative Person's Name: **Jason**

Signature: 

Date : **May 12, 2017**

EU Declaration of Conformity



For the following equipment:

Motherboard

(Product Name)

C621A WS / ASRock

(Model Designation / Trade Name)

ASRock Incorporation

(Manufacturer Name)

2F, No.37, Sec. 2, Jhongyang S. Rd., Beitou District, Taipei City 112, Taiwan (R.O.C.)

(Manufacturer Address)

EMC —Directive 2014/30/EU (from April 20th, 2016)

EN 55022:2010/AC:2011 Class B

EN 55024:2010/A1:2015

EN 55032:2012+AC:2013 Class B

EN 61000-3-3:2013

EN 61000-3-2:2014

LVD —Directive 2014/35/EU (from April 20th, 2016)

EN 60950-1 : 2011+ A2: 2013

EN 60950-1 : 2006/A12: 2011

RoHS — Directive 2011/65/EU

CE marking

(EU conformity marking)



ASRock EUROPE B.V.

(Company Name)

Bijsterhuizen 1111 6546 AR Nijmegen The Netherlands

(Company Address)

Person responsible for making this declaration:

Jason Chou

(Name, Surname)

A.V.P

(Position / Title)

August 22, 2021

(Date)

P/N: 15G062313000AK V1.0