

**ASRock®**



**X99 Extreme4/3.1**

User Manual

Version 1.0

Published March 2015

Copyright©2015 ASRock INC. All rights reserved.

### Copyright Notice:

No part of this documentation may be reproduced, transcribed, transmitted, or translated in any language, in any form or by any means, except duplication of documentation by the purchaser for backup purpose, without written consent of ASRock Inc.

Products and corporate names appearing in this documentation may or may not be registered trademarks or copyrights of their respective companies, and are used only for identification or explanation and to the owners' benefit, without intent to infringe.

### Disclaimer:

Specifications and information contained in this documentation are furnished for informational use only and subject to change without notice, and should not be constructed as a commitment by ASRock. ASRock assumes no responsibility for any errors or omissions that may appear in this documentation.

With respect to the contents of this documentation, ASRock does not provide warranty of any kind, either expressed or implied, including but not limited to the implied warranties or conditions of merchantability or fitness for a particular purpose.

In no event shall ASRock, its directors, officers, employees, or agents be liable for any indirect, special, incidental, or consequential damages (including damages for loss of profits, loss of business, loss of data, interruption of business and the like), even if ASRock has been advised of the possibility of such damages arising from any defect or error in the documentation or product.



This device complies with Part 15 of the FCC Rules. Operation is subject to the following two conditions:

- (1) this device may not cause harmful interference, and
- (2) this device must accept any interference received, including interference that may cause undesired operation.

### CALIFORNIA, USA ONLY

The Lithium battery adopted on this motherboard contains Perchlorate, a toxic substance controlled in Perchlorate Best Management Practices (BMP) regulations passed by the California Legislature. When you discard the Lithium battery in California, USA, please follow the related regulations in advance.

“Perchlorate Material-special handling may apply, see [www.dtsc.ca.gov/hazardouswaste/perchlorate](http://www.dtsc.ca.gov/hazardouswaste/perchlorate)”

**ASRock Website: <http://www.asrock.com>**

Manufactured under license under U.S. Patent Nos: 5,956,674; 5,974,380; 6,487,535; 7,003,467 & other U.S. and worldwide patents issued & pending. DTS, the Symbol, & DTS and the Symbol together is a registered trademark & DTS Connect, DTS Interactive, DTS Neo:PC are trademarks of DTS, Inc. Product includes software.

© DTS, Inc., All Rights Reserved.



# Contents

<b>Chapter 1 Introduction</b>	<b>1</b>
1.1 Package Contents	1
1.2 Specifications	2
1.3 Motherboard Layout	6
1.4 I/O Panel	8
<b>Chapter 2 Installation</b>	<b>10</b>
2.1 Installing the CPU	11
2.2 Installing the CPU Fan and Heatsink	14
2.3 Installation of Memory Modules (DIMM)	15
2.4 Expansion Slots (PCI Express Slots)	17
2.5 Jumpers Setup	19
2.6 Onboard Headers and Connectors	21
2.7 Smart Switches	26
2.8 SLI™, 3-Way SLI™ and Quad SLI™ Operation Guide	27
2.8.1 Installing Two SLI™-Ready Graphics Cards	27
2.8.2 Installing Three SLI™-Ready Graphics Cards	29
2.8.3 Driver Installation and Setup	31
2.9 CrossFireX™, 3-Way CrossFireX™ and Quad CrossFireX™ Operation Guide	32
2.9.1 Installing Two CrossFireX™-Ready Graphics Cards	32
2.9.2 Installing Three CrossFireX™-Ready Graphics Cards	34
2.9.3 Driver Installation and Setup	35

2.10	M.2_SSD (NGFF) Module Installation Guide	36
2.11	HDD Saver Cable Installation Guide	39
2.12	ASRock USB 3.1/A+C Installation Guide	40
<b>Chapter 3 Software and Utilities Operation</b>		<b>42</b>
3.1	Installing Drivers	42
3.2	A-Tuning	43
3.3	ASRock APP Shop	49
3.3.1	UI Overview	49
3.3.2	Apps	50
3.3.3	BIOS & Drivers	53
3.3.4	Setting	54
3.4	Start8	55
<b>Chapter 4 UEFI SETUP UTILITY</b>		<b>58</b>
4.1	Introduction	58
4.1.1	UEFI Menu Bar	58
4.1.2	Navigation Keys	59
4.2	Main Screen	60
4.3	OC Tweaker Screen	61
4.4	Advanced Screen	70
4.4.1	CPU Configuration	71
4.4.2	Chipset Configuration	73
4.4.3	Storage Configuration	76
4.4.4	Super IO Configuration	77
4.4.5	ACPI Configuration	78

4.4.6	USB Configuration	79
4.4.7	Trusted Computing	81
4.5	Tools	82
4.6	Hardware Health Event Monitoring Screen	87
4.7	Security Screen	89
4.8	Boot Screen	90
4.9	Exit Screen	93

# Chapter 1 Introduction

Thank you for purchasing ASRock X99 Extreme4/3.1 motherboard, a reliable motherboard produced under ASRock's consistently stringent quality control. It delivers excellent performance with robust design conforming to ASRock's commitment to quality and endurance.

In this documentation, Chapter 1 and 2 contains the introduction of the motherboard and step-by-step installation guides. Chapter 3 contains the operation guide of the software and utilities. Chapter 4 contains the configuration guide of the BIOS setup.



*Because the motherboard specifications and the BIOS software might be updated, the content of this documentation will be subject to change without notice. In case any modifications of this documentation occur, the updated version will be available on ASRock's website without further notice. If you require technical support related to this motherboard, please visit our website for specific information about the model you are using. You may find the latest VGA cards and CPU support list on ASRock's website as well. ASRock website <http://www.asrock.com>.*

## 1.1 Package Contents

- ASRock X99 Extreme4/3.1 Motherboard (ATX Form Factor)
- ASRock X99 Extreme4/3.1 Quick Installation Guide
- ASRock X99 Extreme4/3.1 Support CD
- 1 x I/O Panel Shield
- 1 x ASRock USB 3.1/A+C
- 1 x ASRock SLI\_Bridge\_2S Card
- 1 x ASRock 3-Way SLI-2S1S Bridge Card
- 4 x Serial ATA (SATA) Data Cables (Optional)
- 1 x HDD Saver Cable
- 1 x Screw for Ultra M.2 Socket

## 1.2 Specifications

- Platform**
- ATX Form Factor
  - 2oz Copper PCB
  - High Density Glass Fabric PCB

- CPU**
- Supports Intel® Core™ i7 and Xeon® 18-Core Processors Family for the LGA 2011-3 Socket
  - Digi Power design
  - 12 Power Phase design
  - Supports Intel® Turbo Boost 2.0 Technology
  - Supports Untied Overclocking Technology

- Chipset**
- Intel® X99

- Memory**
- Quad Channel DDR4 Memory Technology
  - 8 x DDR4 DIMM Slots
  - Supports DDR4 3200+(OC)\*/2933(OC)/2800(OC)/2400(OC)/2133 non-ECC, un-buffered memory
- \* Please refer to Memory Support List on ASRock's website for more information. (<http://www.asrock.com/>)
- Supports non-ECC RDIMM (Registered DIMM)
  - Supports DDR4 ECC, un-buffered memory/RDIMM with Intel® Xeon® processors E5 series in the LGA 2011-3 Socket
  - Max. capacity of system memory: 128GB (see CAUTION)
  - Supports Intel® Extreme Memory Profile (XMP) 2.0
  - 15µ Gold Contact in DIMM Slots

- Expansion Slot**
- 3 x PCI Express 3.0 x16 Slots (PCIE1 @ x16 mode; PCIE3 @ x16 mode; PCIE5 @ x8 mode)
- \* If you install CPU with 28 lanes, PCIE1/PCIE3/PCIE5 will run at x16/x8/x4.
- \* If M.2 PCI Express module is installed, PCIE5 will be disabled.
- 1 x PCI Express 2.0 x16 Slots (PCIE2 @ x4 mode)
  - 1 x PCI Express 2.0 x1 Slot
  - Supports AMD Quad CrossFireX™, 3-Way CrossFireX™ and CrossFireX™
  - Supports NVIDIA® Quad SLI™, 3-Way SLI™ and SLI™



\* If you install CPU with 28 lanes, 3-Way SLI™ is not supported.  
To support 3-Way SLI™, please install the CPU with 40 lanes.

- 15μ Gold Contact in VGA PCIe Slot (PCIE1 and PCIE3)

### Audio

- 7.1 CH HD Audio with Content Protection (Realtek ALC1150 Audio Codec)
- Premium Blu-ray Audio support
- Supports Surge Protection (ASRock Full Spike Protection)
- Supports Purity Sound™ 2
  - Nichicon Fine Gold Series Audio Caps
  - 115dB SNR DAC with Differential Amplifier
  - TI® NE5532 Premium Headset Amplifier (Supports up to 600 Ohms headsets)
  - Direct Drive Technology
  - EMI Shielding Cover
  - PCB Isolate Shielding
- Supports DTS Connect

### LAN

- Gigabit LAN 10/100/1000 Mb/s
- Giga PHY Intel® I218V
- Supports Wake-On-LAN
- Supports Lightning/ESD Protection (ASRock Full Spike Protection)
- Supports Energy Efficient Ethernet 802.3az
- Supports PXE

### Rear Panel I/O

- 1 x PS/2 Mouse Port
- 1 x PS/2 Keyboard Port
- 1 x eSATA Connector
- 1 x Optical SPDIF Out Port
- 4 x USB 2.0 Ports (Supports ESD Protection (ASRock Full Spike Protection))
- 4 x USB 3.0 Ports (Supports ESD Protection (ASRock Full Spike Protection))
- 1 x RJ-45 LAN Port with LED (ACT/LINK LED and SPEED LED)
- 1 x Clear CMOS Switch
- HD Audio Jacks: Rear Speaker / Central / Bass / Line in / Front Speaker / Microphone

**ASRock  
USB 3.1/  
A+C**

- 1 x USB 3.1 Type-A Port (10 Gb/s) (Supports ESD Protection (ASRock Full Spike Protection))
- 1 x USB 3.1 Type-C Port (10 Gb/s) (Supports ESD Protection (ASRock Full Spike Protection))

**Storage**

- 10 x SATA3 6.0 Gb/s Connectors, support RAID (RAID 0, RAID 1, RAID 5, RAID 10 and Intel Rapid Storage 13), NCQ, AHCI, Hot Plug and ASRock HDD Saver Technology (S\_SATA3\_3 connector is shared with the eSATA port) (S\_SATA3\_2 connector is shared with Ultra M.2 Socket)
- \* RAID is supported on SATA3\_0 ~ SATA3\_5 ports only.
- 1 x SATA Express 10 Gb/s Connector (shared with SATA3\_4 and SATA3\_5)
- \* Support to be announced
- 1 x eSATA Connector, supports NCQ, AHCI and Hot Plug
- 1 x Ultra M.2 Socket, supports M.2 SATA3 6.0 Gb/s module and M.2 PCI Express module up to Gen3 x4 (32 Gb/s)

**Connector**

- 1 x COM Port Header
- 1 x TPM Header
- 1 x Power LED Header
- 2 x CPU Fan Connectors (1 x 4-pin, 1 x 3-pin)
- 3 x Chassis Fan Connectors (1 x 4-pin, 2 x 3-pin) (Smart Fan Speed Control)
- 1 x Power Fan Connector (3-pin)
- 1 x 24 pin ATX Power Connector
- 1 x 8 pin 12V Power Connector (Hi-Density Power Connector)
- 1 x HDD Saver Connector
- 1 x PCIe Power Connector
- 1 x Front Panel Audio Connector
- 1 x Thunderbolt AIC Connector
- 2 x USB 2.0 Headers (support 4 USB 2.0 ports) (Supports ESD Protection (ASRock Full Spike Protection))
- 1 x USB 3.0 Header (Supports 2 USB 3.0 ports) (Supports ESD Protection (ASRock Full Spike Protection))

**BIOS  
Feature**

- 2 x 128Mb AMI UEFI Legal BIOS with multilingual GUI support (1 x Main BIOS and 1 x Backup BIOS)
- Supports Secure Backup UEFI Technology

- ACPI 1.1 Compliant wake up events
- SMBIOS 2.3.1 Support
- CPU, DRAM, PCH 1.05V, PCH 1.5V, VPPM Voltage Multi-adjustment

#### **Hardware Monitor**

- CPU/Chassis temperature sensing
- CPU/Chassis/Power Fan Tachometer
- CPU/Chassis Quiet Fan (Auto adjust chassis fan speed by CPU temperature)
- CPU/Chassis Fan multi-speed control
- Voltage monitoring: +12V, +5V, +3.3V, CPU Input Voltage, CPU Internal Voltages

#### **OS**

- Microsoft® Windows® 10 64-bit / 8.1 32-bit / 8.1 64-bit / 8 32-bit / 8 64-bit / 7 32-bit / 7 64-bit

#### **Certifications**

- FCC, CE, WHQL
- ErP/EuP Ready (ErP/EuP ready power supply is required)

\* For detailed product information, please visit our website: <http://www.asrock.com>



Please realize that there is a certain risk involved with overclocking, including adjusting the setting in the BIOS, applying Untied Overclocking Technology, or using third-party overclocking tools. Overclocking may affect your system's stability, or even cause damage to the components and devices of your system. It should be done at your own risk and expense. We are not responsible for possible damage caused by overclocking.



Due to limitation, the actual memory size may be less than 4GB for the reservation for system usage under Windows® 32-bit operating systems. Windows® 64-bit operating systems do not have such limitations. You can use ASRock XFast RAM to utilize the memory that Windows® cannot use.



No.	Description
1	2 x 288-pin DDR4 DIMM Slots (DDR4_A1, DDR4_B1)
2	2 x 288-pin DDR4 DIMM Slots (DDR4_A2, DDR4_B2)
3	ATX 12V Power Connector (ATX12V1)
4	CPU Fan Connector (CPU_FAN1)
5	2 x 288-pin DDR4 DIMM Slots (DDR4_D2, DDR4_C2)
6	CPU Fan Connector (CPU_FAN2)
7	2 x 288-pin DDR4 DIMM Slots (DDR4_D1, DDR4_C1)
8	ATX Power Connector (ATXPWR1)
9	USB 3.0 Header (USB3_4_5)
10	Chassis Fan Connector (CHA_FAN3)
11	SATA3 Connectors (S_SATA3_0_1)
12	SATA3 Connectors (S_SATA3_2_3)
13	SATA3 Connectors (SATA3_0_3)
14	SATA3 Connectors (SATA3_1_4)
15	SATA3 Connectors (SATA3_2_5)
16	SATA Express Connector (SATAE_1)
17	Chassis Fan Connector (CHA_FAN2)
18	Chassis Fan Connector (CHA_FAN1)
19	Power LED Header (PLED1)
20	Chassis Speaker Header (SPEAKER1)
21	System Panel Header (PANEL1)
22	HDD Saver Connector (SATA_PWR_1)
23	USB 2.0 Header (USB4_5)
24	USB 2.0 Header (USB6_7)
25	BIOS Selection Jumper (BIOS_SEL1)
26	Clear CMOS Jumper (CLRCMOS1)
27	COM Port Header (COM1)
28	TPM Header (TPMS1)
29	Front Panel Audio Header (HD_AUDIO1)
30	Thunderbolt AIC Connector (TBT1)
31	PCIe Power Connector (PCIE_PWR1)
32	Power Fan Connector (PWR_FAN1)

## 1.4 I/O Panel

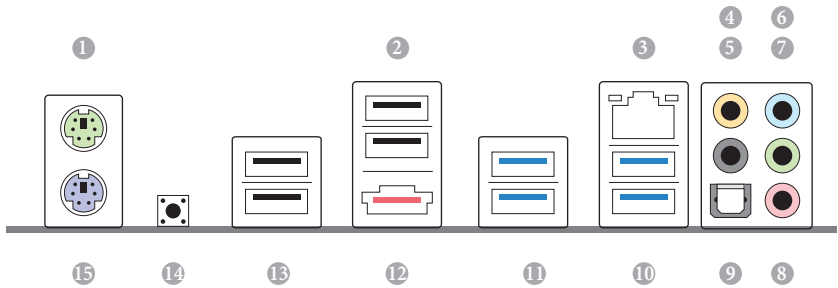

No.	Description	No.	Description
1	PS/2 Mouse Port	9	Optical SPDIF Out Port
2	USB 2.0 Ports (USB23)	10	USB 3.0 Ports (USB3_23)
3	LAN RJ-45 Port*	11	USB 3.0 Ports (USB3_01)
4	Central / Bass (Orange)	12	eSATA Connector***
5	Rear Speaker (Black)	13	USB 2.0 Ports (USB01)
6	Line In (Light Blue)	14	Clear CMOS Switch
7	Front Speaker (Lime)**	15	PS/2 Keyboard Port
8	Microphone (Pink)		

\* There are two LEDs on each LAN port. Please refer to the table below for the LAN port LED indications.

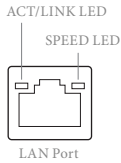

Activity / Link LED		Speed LED	
Status	Description	Status	Description
Off	No Link	Off	10Mbps connection
Blinking	Data Activity	Orange	100Mbps connection
On	Link	Green	1Gbps connection

\*\* If you use a 2-channel speaker, please connect the speaker's plug into "Front Speaker Jack". See the table below for connection details in accordance with the type of speaker you use.

Audio Output Channels	Front Speaker (No. 7)	Rear Speaker (No. 5)	Central / Bass (No. 4)	Line In (No. 6)
2	V	--	--	--
4	V	V	--	--
6	V	V	V	--
8	V	V	V	V



To enable Multi-Streaming, you need to connect a front panel audio cable to the front panel audio header. After restarting your computer, you will find the "Mixer" tool on your system. Please select "Mixer Toolbox" , click "Enable playback multi-streaming", and click "ok". Choose "2CH", "4CH", "6CH", or "8CH" and then you are allowed to select "Realtek HDA Primary output" to use the Rear Speaker, Central/Bass, and Front Speaker, or select "Realtek HDA Audio 2nd output" to use the front panel audio.

\*\*\* The eSATA connector supports SATA with cables within 1 meters. The S\_SATA3\_3 connector is shared with the eSATA port

---

## Chapter 2 Installation

This is an ATX form factor motherboard. Before you install the motherboard, study the configuration of your chassis to ensure that the motherboard fits into it.

### Pre-installation Precautions

Take note of the following precautions before you install motherboard components or change any motherboard settings.

- Make sure to unplug the power cord before installing or removing the motherboard components. Failure to do so may cause physical injuries and damages to motherboard components.
- In order to avoid damage from static electricity to the motherboard's components, NEVER place your motherboard directly on a carpet. Also remember to use a grounded wrist strap or touch a safety grounded object before you handle the components.
- Hold components by the edges and do not touch the ICs.
- Whenever you uninstall any components, place them on a grounded anti-static pad or in the bag that comes with the components.
- When placing screws to secure the motherboard to the chassis, please do not over-tighten the screws! Doing so may damage the motherboard.



## 2.1 Installing the CPU



1. Before you insert the **2011-3-Pin CPU** into the socket, please check if the **PnP cap** is on the socket, if the CPU surface is unclean, or if there are any **bent pins** in the socket. Do not force to insert the CPU into the socket if above situation is found. Otherwise, the CPU will be seriously damaged.
2. Unplug all power cables before installing the CPU.

### **CAUTION:**

Please note that X99 platform is only compatible with the **LGA 2011-3 socket**, which is incompatible with the LGA 2011 socket (for X79 platform).

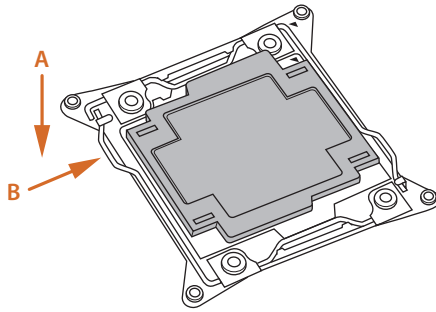
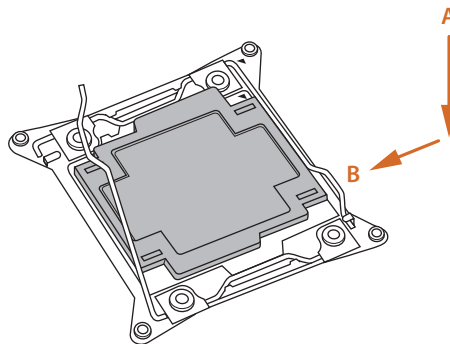
**1****2**

3

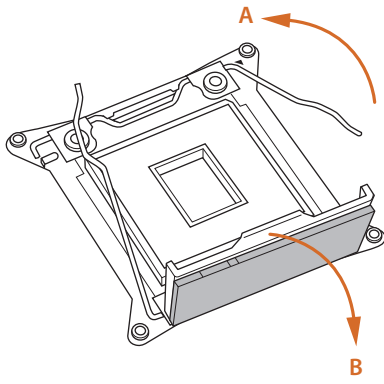

4

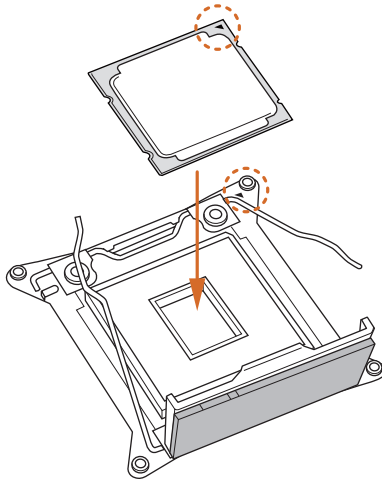

5

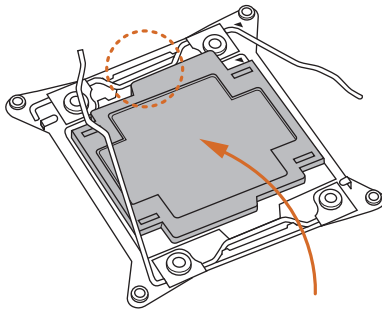

6

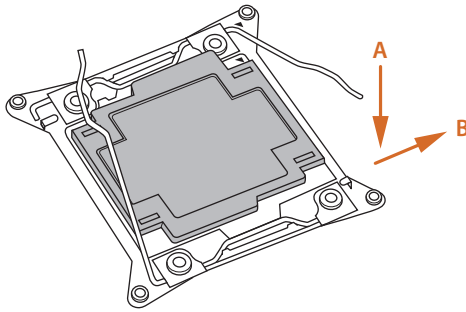

7

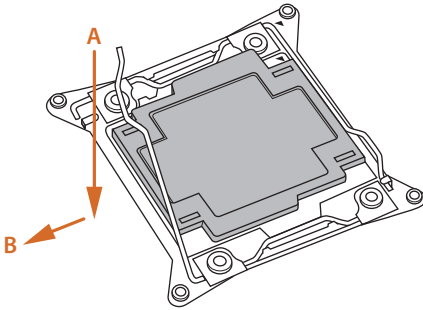

8

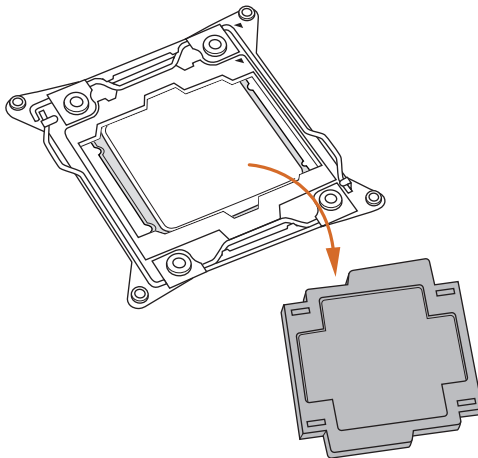

Please save and replace the cover if the processor is removed. The cover must be placed if you wish to return the motherboard for after service.

## 2.2 Installing the CPU Fan and Heatsink

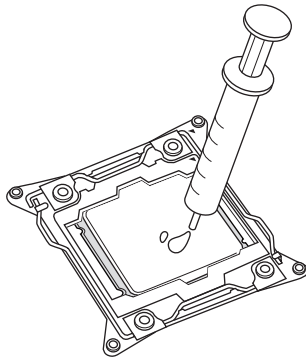

1

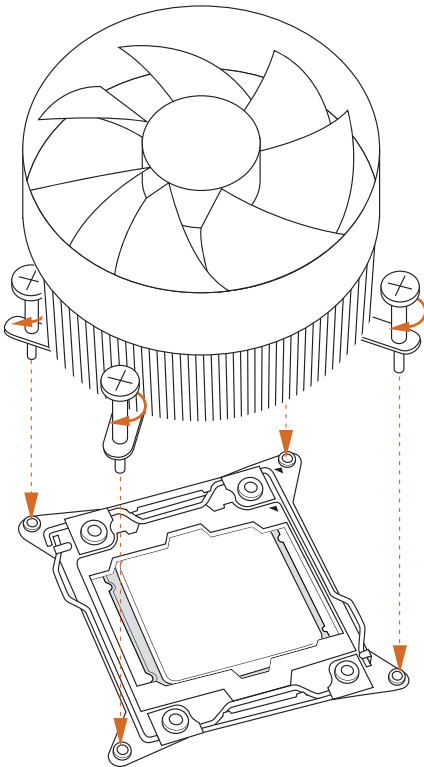

2

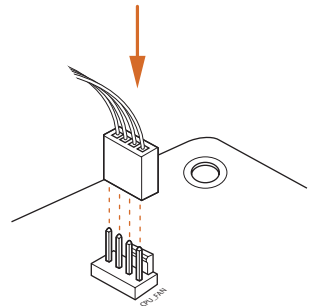

## 2.3 Installation of Memory Modules (DIMM)

This motherboard provides eight 288-pin DDR4 (Double Data Rate 4) DIMM slots, and supports Quad Channel Memory Technology.



1. For quad channel configuration, you always need to install identical (the same brand, speed, size and chip-type) DDR4 DIMM pairs.
2. It is not allowed to install a DDR, DDR2 or DDR3 memory module into a DDR4 slot; otherwise, this motherboard and DIMM may be damaged.
3. The DIMM only fits in one correct orientation. It will cause permanent damage to the motherboard and the DIMM if you force the DIMM into the slot at incorrect orientation.

### Quad Channel Memory Configuration

Priority	1	2
DDR4_A1	Populated	Populated
DDR4_A2		Populated
DDR4_B1	Populated	Populated
DDR4_B2		Populated
DDR4_C1	Populated	Populated
DDR4_C2		Populated
DDR4_D1	Populated	Populated
DDR4_D2		Populated

- Due to Intel® CPU spec definition, please install the memory modules on DDR4\_A1, DDR4\_B1, DDR4\_C1 and DDR4\_D1 for first priority. If the four DDR4 DIMM slots above are fully installed, and you want to use more than four memory modules, please install the other memory modules from left to right (from DDR4\_A2, DDR4\_B2, DDR4\_D2 to DDR4\_C2.)
- If only two memory modules are installed in the DDR4 DIMM slots, then Dual Channel Memory Technology is activated. If three memory modules are installed, then Triple Channel Memory Technology is activated. If more than four memory modules are installed in the DDR4 DIMM slots, then Quad Channel Memory Technology is activated.

1

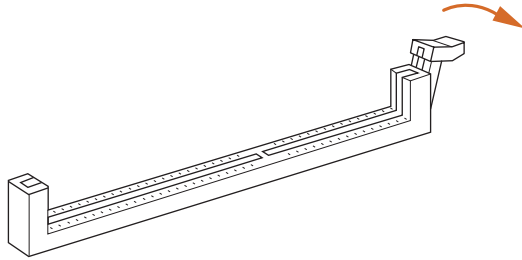

2

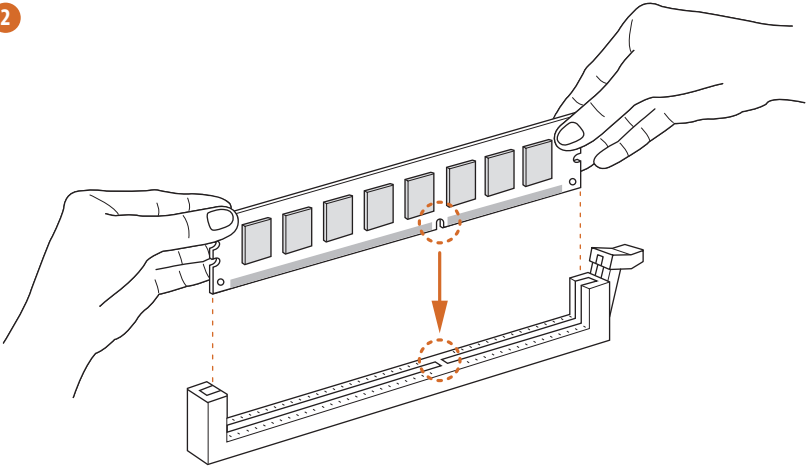

3

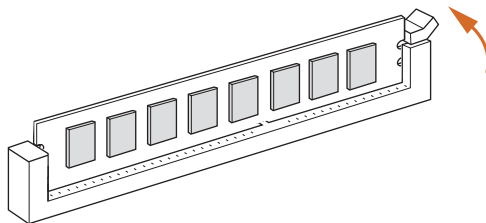

## 2.4 Expansion Slots (PCI Express Slots)

There are 5 PCI Express slots on the motherboard.



*Before installing an expansion card, please make sure that the power supply is switched off or the power cord is unplugged. Please read the documentation of the expansion card and make necessary hardware settings for the card before you start the installation.*

### PCIe slots:

PCIE1 (PCIe 3.0 x16 slot) is used for PCI Express x16 lane width graphics cards.

PCIE2 (PCIe 2.0 x16 slot) is used for PCI Express x4 lane width cards.

PCIE3 (PCIe 3.0 x16 slot) is used for PCI Express x16 lane width graphics cards.

PCIE4 (PCIe 2.0 x1 slot) is used for PCI Express x1 lane width cards.

PCIE5 (PCIe 3.0 x16 slot) is used for PCI Express x8 lane width graphics cards.

\* If M.2 PCI Express module is installed, PCIE5 will be disabled.

### PCIe Slot Configurations (For CPU with 40 PCIe lanes)

	PCIE1	PCIE2	PCIE3	PCIE4	PCIE5
<b>Single Graphics Card</b>	x16	N/A	N/A	N/A	N/A
<b>Two Graphics Cards in CrossFireX™ or SLI™ Mode</b>	x16	N/A	x16	N/A	N/A
<b>Three Graphics Cards in 3-Way CrossFireX™ Mode or 3-Way SLI™ Mode</b>	x16	N/A	x16	N/A	x8

## PCIe Slot Configurations (For CPU with 28 PCIe lanes)

	PCI E1	PCI E2	PCI E3	PCI E4	PCI E5
<b>Single Graphics Card</b>	x16	N/A	N/A	N/A	N/A
<b>Two Graphics Cards in CrossFireX™ or SLI™ Mode</b>	x16	N/A	x8	N/A	N/A
<b>Three Graphics Cards in 3-Way CrossFireX™ Mode</b>	x16	N/A	x8	N/A	x4

\*3-Way SLI™ Mode is not supported for CPU with 28 PCIe lanes.



*For a better thermal environment, please connect a chassis fan to the motherboard's chassis fan connector (CHA\_FAN1, CHA\_FAN2 or CHA\_FAN3) when using multiple graphics cards.*



## 2.5 Jumpers Setup

The illustration shows how jumpers are setup. When the jumper cap is placed on the pins, the jumper is “Short”. If no jumper cap is placed on the pins, the jumper is “Open”. The illustration shows a 3-pin jumper whose pin1 and pin2 are “Short” when a jumper cap is placed on these 2 pins.

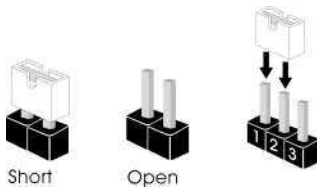

Clear CMOS Jumper  
(CLR CMOS1)  
(see p.6, No. 26)

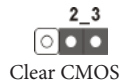

CLR CMOS1 allows you to clear the data in CMOS. To clear and reset the system parameters to default setup, please turn off the computer and unplug the power cord from the power supply. After waiting for 15 seconds, use a jumper cap to short pin2 and pin3 on CLR CMOS1 for 5 seconds. However, please do not clear the CMOS right after you update the BIOS. If you need to clear the CMOS when you just finish updating the BIOS, you must boot up the system first, and then shut it down before you do the clear-CMOS action. Please be noted that the password, date, time, and user default profile will be cleared only if the CMOS battery is removed.



*The Clear CMOS Switch has the same function as the Clear CMOS jumper.*

---

BIOS Selection Jumper  
(BIOS\_SEL1)  
(see p.6, No. 25)

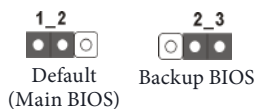

---

This motherboard has two BIOS onboard, a main BIOS (BIOS\_A) and a backup BIOS (BIOS\_B), which enhances protection for the safety and stability of your system. Normally, the system works on the main BIOS. However, if the main BIOS is corrupted or damaged, please use a jumper cap to short pin2 and pin3, then the backup BIOS will take over on the next system boot. After that, use “Secure Backup UEFI” in BIOS setup utility to copy the BIOS file to the main BIOS to ensure normal system operation. For the sake of system safety, users cannot update the backup BIOS manually. Users may refer to the BIOS LED (BIOS\_A\_LED or BIOS\_B\_LED) to identify which BIOS is activated currently.

## 2.6 Onboard Headers and Connectors



Onboard headers and connectors are NOT jumpers. Do NOT place jumper caps over these headers and connectors. Placing jumper caps over the headers and connectors will cause permanent damage to the motherboard.

**System Panel Header**  
(9-pin PANEL1)  
(see p.6, No. 21)

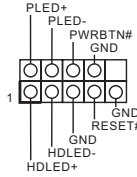

Connect the power switch, reset switch and system status indicator on the chassis to this header according to the pin assignments below. Note the positive and negative pins before connecting the cables.



**PWRBTN (Power Switch):**

Connect to the power switch on the chassis front panel. You may configure the way to turn off your system using the power switch.

**RESET (Reset Switch):**

Connect to the reset switch on the chassis front panel. Press the reset switch to restart the computer if the computer freezes and fails to perform a normal restart.

**PLED (System Power LED):**

Connect to the power status indicator on the chassis front panel. The LED is on when the system is operating. The LED keeps blinking when the system is in S1/S3 sleep state. The LED is off when the system is in S4 sleep state or powered off (S5).

**HDLED (Hard Drive Activity LED):**

Connect to the hard drive activity LED on the chassis front panel. The LED is on when the hard drive is reading or writing data.

The front panel design may differ by chassis. A front panel module mainly consists of power switch, reset switch, power LED, hard drive activity LED, speaker and etc. When connecting your chassis front panel module to this header, make sure the wire assignments and the pin assignments are matched correctly.

Power LED Header  
(3-pin PLED1)  
(see p.6, No. 19)

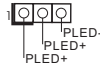

Please connect the chassis power LED to this header to indicate the system's power status.

Serial ATA3 Connectors  
(S\_SATA3\_0\_1:  
see p.6, No. 11)  
(S\_SATA3\_2\_3:  
see p.6, No. 12)  
(SATA3\_0\_3:  
see p.6, No. 13)  
(SATA3\_1\_4:  
see p.6, No. 14)  
(SATA3\_2\_5:  
see p.6, No. 15)



These ten SATA3 connectors support SATA data cables for internal storage devices with up to 6.0 Gb/s data transfer rate. If the eSATA port on the rear I/O has been connected, the internal S\_SATA3\_3 will not function. If the Ultra M.2 Socket has been occupied, the internal S\_SATA3\_2 will not function.  
\* RAID is supported on SATA3\_0 ~ SATA3\_5 ports only.

Serial ATA Express Connector  
(SATA\_EXP0:  
see p.6, No. 16)



Please connect either SATA or PCIe storage devices to this connector. The SATA Express connector is shared with the SATA3\_4 and the SATA3\_5.  
\*The SATA Express interface is a combination of SATAE\_1, SATA3\_5, and SATA3\_4.

**USB 2.0 Headers**  
 (9-pin USB4\_5)  
 (see p.6, No. 23)  
 (9-pin USB6\_7)  
 (see p.6, No. 24)

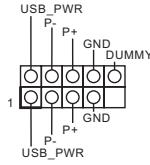

Besides four USB 2.0 ports on the I/O panel, there are two headers on this motherboard. Each USB 2.0 header can support two ports.

**USB 3.0 Header**  
 (19-pin USB3\_4\_5)  
 (see p.6, No. 9)

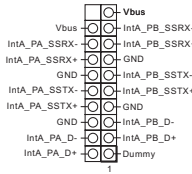

Besides four USB 3.0 ports on the I/O panel, there is one header on this motherboard. This USB 3.0 header can support two ports.

**Front Panel Audio Header**  
 (9-pin HD\_AUDIO1)  
 (see p.6, No. 29)

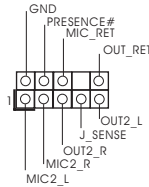

This header is for connecting audio devices to the front audio panel.



1. High Definition Audio supports Jack Sensing, but the panel wire on the chassis must support HDA to function correctly. Please follow the instructions in our manual and chassis manual to install your system.
2. If you use an AC'97 audio panel, please install it to the front panel audio header by the steps below:
  - A. Connect Mic\_IN (MIC) to MIC2\_L.
  - B. Connect Audio\_R (RIN) to OUT2\_R and Audio\_L (LIN) to OUT2\_L.
  - C. Connect Ground (GND) to Ground (GND).
  - D. MIC\_RET and OUT\_RET are for the HD audio panel only. You don't need to connect them for the AC'97 audio panel.
  - E. To activate the front mic, go to the "FrontMic" Tab in the Realtek Control panel and adjust "Recording Volume".

**Chassis Speaker Header**  
 (4-pin SPEAKER1)  
 (see p.6, No. 20)

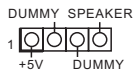

Please connect the chassis speaker to this header.

Chassis and Power Fan  
Connectors

(4-pin CHA\_FAN1)

(see p.6, No. 18)

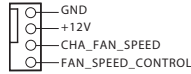

(3-pin CHA\_FAN2)

(see p.6, No. 17)

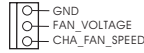

(3-pin CHA\_FAN3)

(see p.6, No. 10)

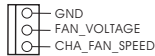

(3-pin PWR\_FAN1)

(see p.6, No. 32)

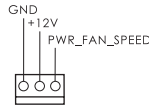

Please connect fan cables to the fan connectors and match the black wire to the ground pin. CHA\_FAN fan speed can be controlled through UEFI or A-Tuning.

CPU Fan Connectors

(4-pin CPU\_FAN1)

(see p.6, No. 4)

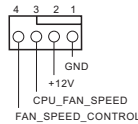

(3-pin CPU\_FAN2)

(see p.6, No. 6)



This motherboard provides a 4-Pin CPU fan (Quiet Fan) connector. If you plan to connect a 3-Pin CPU fan, please connect it to Pin 1-3.

ATX Power Connector

(24-pin ATXPWR1)

(see p.6, No. 8)

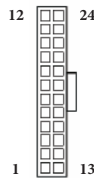

This motherboard provides a 24-pin ATX power connector. To use a 20-pin ATX power supply, please plug it along Pin 1 and Pin 13.

ATX 12V Power

Connector

(8-pin ATX12V1)

(see p.6, No. 3)

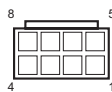

This motherboard provides an 8-pin ATX 12V power connector. To use a 4-pin ATX power supply, please plug it along Pin 1 and Pin 5.

PCIe Power Connector  
(4-pin PCIe\_PWR1)  
(see p.6, No. 31)

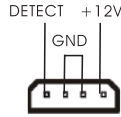

Please connect a 4 pin molex power cable to this connector when more than three PCI Express cards are installed.

HDD Saver Connector  
(4-pin SATA\_PWR\_1)  
(see p.6, No. 21)



Please connect the HDD Saver Cable to this connector to manage the power state of HDD.

Thunderbolt AIC Connector  
(5-pin TBT1)  
(see p.6, No. 30)



Please connect a Thunderbolt™ add-in card (AIC) to this connector via the GPIO cable.

Serial Port Header  
(9-pin COM1)  
(see p.6, No. 27)

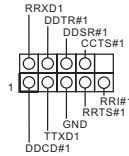

This COM1 header supports a serial port module.

TPM Header  
(17-pin TPMS1)  
(see p.6, No. 28)

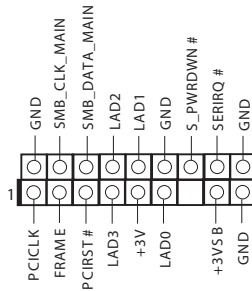

This connector supports Trusted Platform Module (TPM) system, which can securely store keys, digital certificates, passwords, and data. A TPM system also helps enhance network security, protects digital identities, and ensures platform integrity.

## 2.7 Smart Switches

The motherboard has a Clear CMOS Switch, allowing users to clear the CMOS values.

---

Clear CMOS Switch  
(CLRCBTN)  
(see p.8, No. 14)



Clear CMOS Switch  
allows users to quickly  
clear the CMOS values.



*This function is workable only when you power off your computer and unplug the power supply.*



## 2.8 SLI™, 3-Way SLI™ and Quad SLI™ Operation Guide

This motherboard supports NVIDIA® SLI™, 3-Way SLI™ and Quad SLI™ (Scalable Link Interface) technology that allows you to install up to three identical PCI Express x16 graphics cards. Currently, NVIDIA® SLI™ and Quad SLI™ technology supports Windows® 7 / 7 64-bit / 8 / 8 64-bit / 8.1 / 8.1 64-bit OS.

\* If you install CPU with 28 lanes, 3-Way SLI™ is not supported.



### Requirements

1. You should only use identical SLI™-ready graphics cards that are NVIDIA® certified.
2. Make sure that your graphics card driver supports NVIDIA® SLI™ technology. Download the drivers from the NVIDIA® website: [www.nvidia.com](http://www.nvidia.com)
3. Make sure that your power supply unit (PSU) can provide at least the minimum power your system requires. It is recommended to use a NVIDIA® certified PSU. Please refer to the NVIDIA® website for details.

### 2.8.1 Installing Two SLI™-Ready Graphics Cards

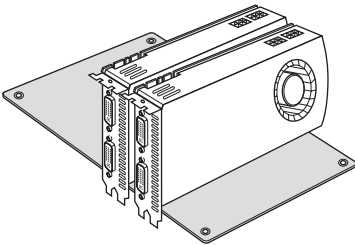

#### Step 1

Insert one graphics card into PCI-E1 slot and the other graphics card to PCI-E3 slot. Make sure that the cards are properly seated on the slots.

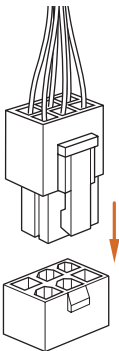

#### Step 2

If required, connect the auxiliary power source to the PCI Express graphics cards.

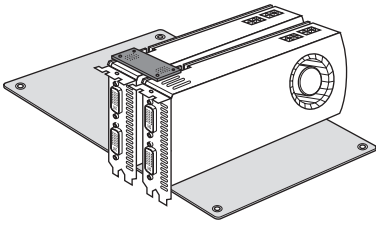

### **Step 3**

Align and insert the ASRock SLI\_Bridge\_2S Card to the goldfingers on each graphics card. Make sure the ASRock SLI\_Bridge\_2S Card is firmly in place.



ASRock SLI\_Bridge\_2S Card

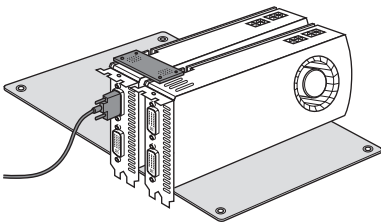

### **Step 4**

Connect a VGA cable or a DVI cable to the monitor connector or the DVI connector of the graphics card that is inserted to PCI-E slot.

## 2.8.2 Installing Three SLI™-Ready Graphics Cards

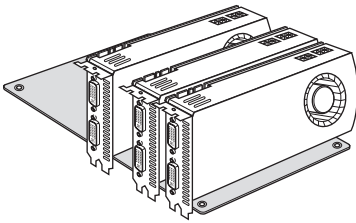

### Step 1

Insert one graphics card into PCIe1 slot, another graphics card to PCIe3 slot, and the other graphics card to PCIe5 slot. Make sure that the cards are properly seated on the slots.

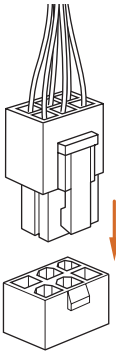

### Step 2

Connect the auxiliary power source to the PCI Express graphics card. Please make sure that both power connectors on the PCI Express graphics card are connected. Repeat this step on the three graphics cards.

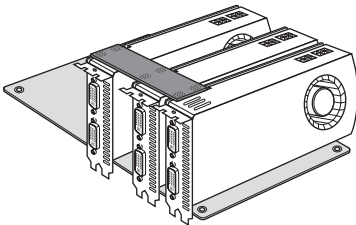

### Step 3

Align and insert the ASRock 3-Way SLI-2S1S Bridge Card to the goldfingers on each graphics card. Make sure the ASRock 3-Way SLI-2S1S Bridge Card is firmly in place.

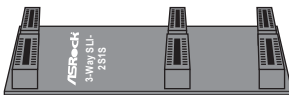

3-Way SLI-2S1S Bridge Card

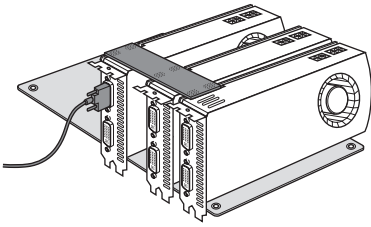

**Step 4**

Connect a VGA cable or a DVI cable to the monitor connector or the DVI connector of the graphics card that is inserted to PCIE1 slot.

## 2.8.3 Driver Installation and Setup

Install the graphics card drivers to your system. After that, you can enable the Multi-Graphics Processing Unit (GPU) in the NVIDIA® nView system tray utility. Please follow the below procedures to enable the multi-GPU.



### Step 1

Double-click the **NVIDIA Control Panel** icon in the Windows® system tray.



### Step 2

In the left pane, click **Set SLI and PhysX configuration**. Then select **Maximize 3D performance** and click **Apply**.

### Step 3

Reboot your system.

## 2.9 CrossFireX™, 3-Way CrossFireX™ and Quad CrossFireX™ Operation Guide

This motherboard supports CrossFireX™, 3-way CrossFireX™ and Quad CrossFireX™ that allows you to install up to three identical PCI Express x16 graphics cards. Currently CrossFireX™, 3-way CrossFireX™ and Quad CrossFireX™ are supported with Windows® 7 / 7 64-bit / 8 / 8 64-bit / 8.1 / 8.1 64-bit OS.



1. You should only use identical CrossFireX™-ready graphics cards that are AMD certified.
2. Make sure that your graphics card driver supports AMD CrossFireX™ technology. Download the drivers from the AMD's website: [www.amd.com](http://www.amd.com)
3. Make sure that your power supply unit (PSU) can provide at least the minimum power your system requires. It is recommended to use a AMD certified PSU. Please refer to the AMD's website for details.
4. If you pair a 12-pipe CrossFireX™ Edition card with a 16-pipe card, both cards will operate as 12-pipe cards while in CrossFireX™ mode.
5. Different CrossFireX™ cards may require different methods to enable CrossFireX™. Please refer to AMD graphics card manuals for detailed installation guide.

### 2.9.1 Installing Two CrossFireX™-Ready Graphics Cards

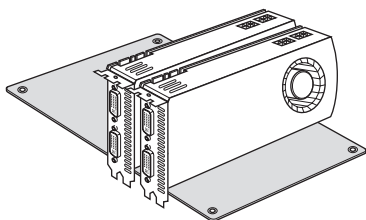

#### Step 1

Insert one graphics card into PCI E1 slot and the other graphics card to PCI E3 slot. Make sure that the cards are properly seated on the slots.



CrossFire Bridge

#### Step 2

Connect two graphics cards by installing a CrossFire Bridge on the CrossFire Bridge Interconnects on the top of the graphics cards. (The CrossFire Bridge is provided with the graphics card you purchase, not bundled with this motherboard. Please refer to your graphics card vendor for details.)

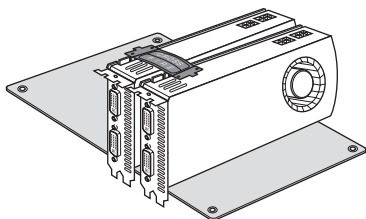

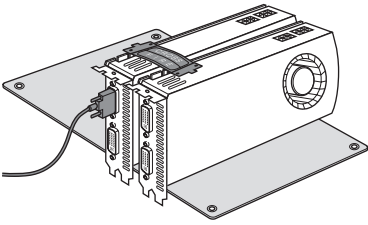
**Step 3**

Connect a VGA cable or a DVI cable to the monitor connector or the DVI connector of the graphics card that is inserted to PCIE1 slot.

## 2.9.2 Installing Three CrossFireX™-Ready Graphics Cards

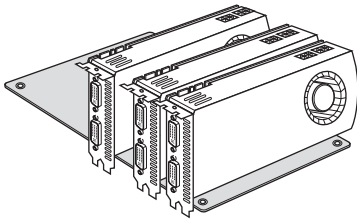

### Step 1

Insert one graphics card into PCIE1 slot, another graphics card to PCIE3 slot, and the other graphics card to PCIE5 slot. Make sure that the cards are properly seated on the slots.



CrossFire Bridge

### Step 2

Use one CrossFire Bridge to connect the graphics cards on PCIE1 and PCIE3 slots, and use the other CrossFire Bridge to connect the graphics cards on PCIE3 and PCIE5 slots. (The CrossFire Bridge is provided with the graphics card you purchase, not bundled with this motherboard. Please refer to your graphics card vendor for details.)

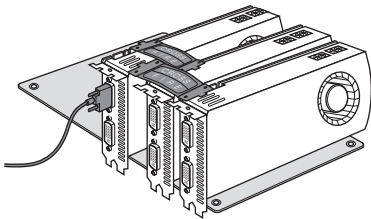
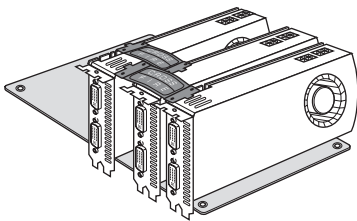

### Step 3

Connect a VGA cable or a DVI cable to the monitor connector or the DVI connector of the graphics card that is inserted to PCIE1 slot.



## 2.9.3 Driver Installation and Setup

### Step 1

Power on your computer and boot into OS.

### Step 2

Remove the AMD drivers if you have any VGA drivers installed in your system.



*The Catalyst Uninstaller is an optional download. We recommend using this utility to uninstall any previously installed Catalyst drivers prior to installation. Please check AMD's website for AMD driver updates.*

### Step 3

Install the required drivers and CATALYST Control Center then restart your computer. Please check AMD's website for details.



AMD Catalyst Control Center

### Step 4

Double-click the **AMD Catalyst Control Center** icon in the Windows' system tray.



### Step 5

In the left pane, click **Performance** and then **AMD CrossFireX™**. Then select **Enable AMD CrossFireX** and click **Apply**. Select the GPU number according to your graphics card and click **Apply**.

## 2.10 M.2\_SSD (NGFF) Module Installation Guide

The M.2, also known as the Next Generation Form Factor (NGFF), is a small size and versatile card edge connector that aims to replace mPCIe and mSATA. The Ultra M.2 Socket (M2\_1) can accommodate either a M.2 SATA3 6.0 Gb/s module or a M.2 PCI Express module up to Gen3 x4 (32 Gb/s). Please be noted that the Ultra M.2 Socket (M2\_1) is shared with the S\_SATA3\_2 connector; you can only choose either the Ultra M.2 Socket (M2\_1) or the S\_SATA3\_2 connector to use.

\* If M.2 PCI Express module is installed, PCIE5 will be disabled.

### Installing the M.2\_SSD (NGFF) Module

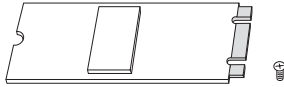

#### Step 1

Prepare a M.2\_SSD (NGFF) module and the screw.

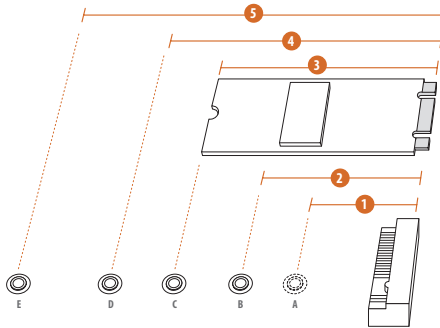

#### Step 2

Depending on the PCB type and length of your M.2\_SSD (NGFF) module, find the corresponding nut location to be used.

No.	1	2	3	4	5
Nut Location	A	B	C	D	E
PCB Length	3cm	4.2cm	6cm	8cm	11cm
Module Type	Type2230	Type 2242	Type2260	Type 2280	Type 22110

**Step 3**

Move the standoff based on the module type and length. The standoff is placed at the nut location D by default. Skip Step 3 and 4 and go straight to Step 5 if you are going to use the default nut. Otherwise, release the standoff by hand.

**Step 4**

Peel off the yellow protective film on the nut to be used. Hand tighten the standoff into the desired nut location on the motherboard.

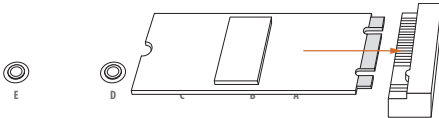
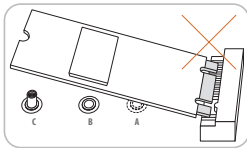
**Step 5**

Align and gently insert the M.2 (NGFF) SSD module into the M.2 slot. Please be aware that the M.2 (NGFF) SSD module only fits in one orientation.

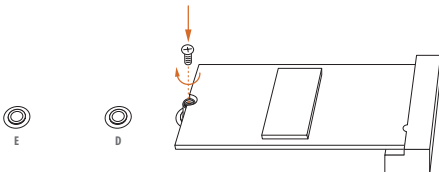
**Step 6**

Tighten the screw with a screwdriver to secure the module into place. Please do not overtighten the screw as this might damage the module.

## M.2\_SSD (NGFF) Module Support List

PCIe Interface	SATA Interface
Plextor PX-G512M6e	ADATA AXNS381E-128GM-B
Plextor PX-G256M6e	ADATA AXNS381E-256GM-B
SanDisk SD6PP4M-128G	Crucial CT120M500SSD4/120G
SanDisk SD6PP4M-256G	Crucial CT240M500SSD4/240G
Samsung XP941-512G (MZHPU512HCGL)	Intel SSDSCKGW080A401/80G
	Kingston RBU-SM2280S3/120G

For the latest updates of M.2\_SSD (NFGG) module support list, please visit our website for details: <http://www.asrock.com>

## 2.11 HDD Saver Cable Installation Guide

The HDD Saver Connector on this motherboard allows you to switch on and off the connected HDDs via software when needed. This design secures more privacy, saves more energy, and extends the HDDs' lifespans. Please follow the steps below to install the HDD Saver Cable.

### Connection Diagram

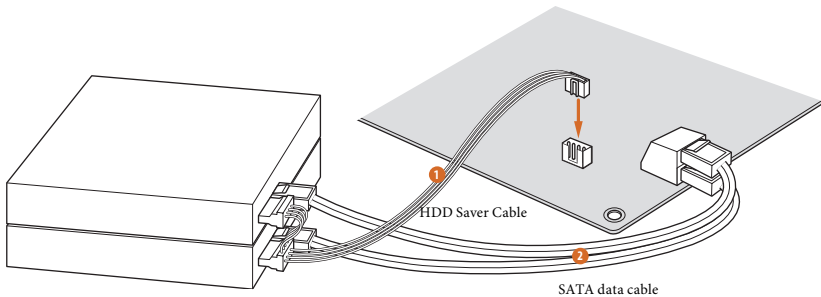

\*The diagram shown here is for reference only.

1. Connect one end of the HDD Saver Cable to the **HDD Saver Connector (SATA\_PWR\_1)** placed near the SATA ports. Then connect the SATA power connector(s) to your SATA HDD(s).

\* The HDD Saver Connector supports up to two SATA HDDs.

2. Connect one end of the SATA data cable to a SATA port on the motherboard. Then connect the other end to your SATA HDD(s).



*For the software configuration, please refer to the section 3.2 "A-Tuning" in this user manual.*

## 2.12 ASRock USB 3.1/A+C Installation Guide

### Specifications

<b>Platform</b>	<ul style="list-style-type: none"><li>• Size: 3.1-in x 3.2-in, 7.9 cm x 8.1 cm</li></ul>
<b>Controller</b>	<ul style="list-style-type: none"><li>• ASMedia ASM1142 Controller</li></ul>
<b>PCIE</b>	<ul style="list-style-type: none"><li>• PCI Express x4 Connector (x2 lane)</li><li>• Compliant with PCI Express 1.1, 2.0 and 3.0 specifications</li><li>• Supports data rates up to 10 Gbps</li><li>• Compliant with x4, x8 or x16 PCI Express Slots</li></ul>
<b>Connector</b>	<ul style="list-style-type: none"><li>• 1 x USB 3.1 Type-A Port (Supports ESD Protection (ASRock Full Spike Protection))</li></ul> <p>* For charging Type-A USB devices, we suggest using the Type-A connectors on your motherboard.</p> <ul style="list-style-type: none"><li>• 1 x USB 3.1 Type-C Port (Supports ESD Protection (ASRock Full Spike Protection))</li></ul> <p>* This port supports power outputs up to 5V/3A. For charging Type-C USB devices, the device should support Type-C standards to adjust the current because it will be different in Power On state (3 Amp) and Sleep state (1 Amp).</p> <p>* Some Type-C USB devices may only be charged by its own adapter.</p>
<b>OS</b>	<ul style="list-style-type: none"><li>• Microsoft® Windows® 8.1 32-bit / 8.1 64-bit / 8 32-bit / 8 64-bit / 7 32-bit / 7 64-bit</li></ul>

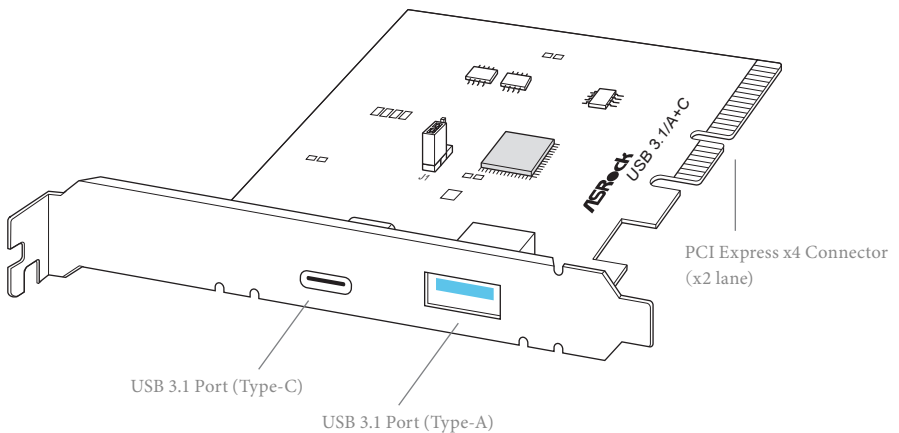

## Installation Procedure

The ASRock USB 3.1/A+C provides two external USB 3.1 ports which support transfer rates up to 10 Gbps. Follow the simple steps below to install the ASRock USB 3.1/A+C.

### **Step 1**

Power off the PC and unplug the power cord. Detach all other cables from the PC.

### **Step 2**

Remove the side panel from the computer case.

\*Refer to the documentation that comes with your PC for details.

### **Step 3**

Locate an available x4, x8 or x16 PCI Express slot on your motherboard and remove its slot bracket.

\*To maximize the performance of ASRock USB 3.1/A+C, it is highly recommended to insert the card into the PCIE3 (from CPU) if the slot is not occupied by graphics card. If the PCIE3 is occupied, insert the card into PCIE2 (from PCH).

### **Step 4**

Align the ASRock USB 3.1/A+C with the PCI Express slot and press down firmly until it is fully seated in the slot. Then secure the card with the slot bracket's holding screw.

### **Step 5**

Replace the side panel. Reconnect the power cord and any other cables that were disconnected.

#### **Jumper Setup:**

Jumper J1 is set to Pin1-2 by default and allows device charging during S3 (Sleep), S4 (Suspend) or S5 (Power Off) power states. To disable device charging during S3/S4/S5 (Power Off) power states, you need to move the jumper cap placed on Pin1-2 (default) to Pin2-3.

\*Please install driver for Windows® 7 (32-bit and 64-bit).

# Chapter 3 Software and Utilities Operation

## 3.1 Installing Drivers

The Support CD that comes with the motherboard contains necessary drivers and useful utilities that enhance the motherboard's features.

### Running The Support CD

To begin using the support CD, insert the CD into your CD-ROM drive. The CD automatically displays the Main Menu if "AUTORUN" is enabled in your computer. If the Main Menu does not appear automatically, locate and double click on the file "ASRSETUP.EXE" in the Support CD to display the menu.

### Drivers Menu

The drivers compatible to your system will be auto-detected and listed on the support CD driver page. Please click **Install All** or follow the order from top to bottom to install those required drivers. Therefore, the drivers you install can work properly.

### Utilities Menu

The Utilities Menu shows the application software that the motherboard supports. Click on a specific item then follow the installation wizard to install it.



*To improve Windows 7 compatibility, please download and install the following hot fix provided by Microsoft.  
"KB2720599": <http://support.microsoft.com/kb/2720599/en-us>*



## 3.2 A-Tuning

A-Tuning is ASRock's multi purpose software suite with a new interface, more new features and improved utilities, including XFast RAM, Dehumidifier, Good Night LED, FAN-Tastic Tuning, OC Tweaker and a whole lot more.

### 3.2.1 Installing A-Tuning

When you install the all-in-one driver to your system from ASRock's support CD, A-Tuning will be auto-installed as well. After the installation, you will find the icon "A-Tuning" on your desktop. Double-click the "A-Tuning"  icon, A-Tuning main menu will pop up.

### 3.2.2 Using A-Tuning

There are six sections in A-Tuning main menu: Operation Mode, Tools, OC Tweaker, System Info, Live Update, Tech Service and Settings.

#### Operation Mode

Choose an operation mode for your computer.

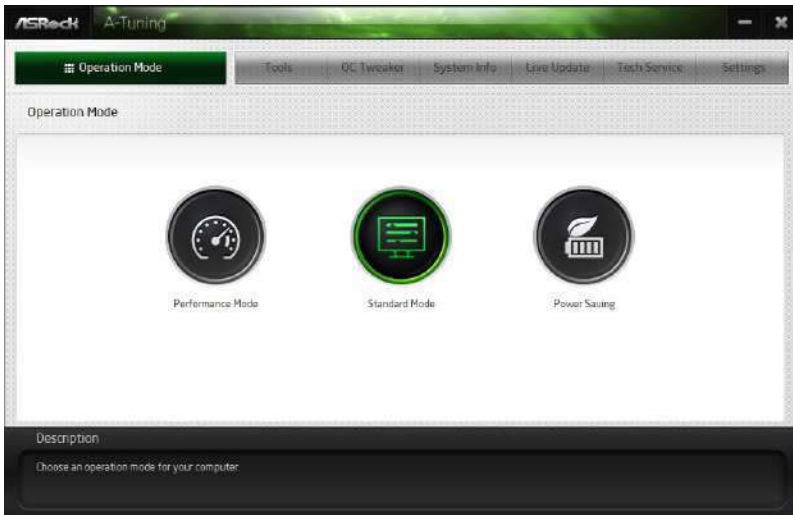

## Tools

Various tools and utilities.

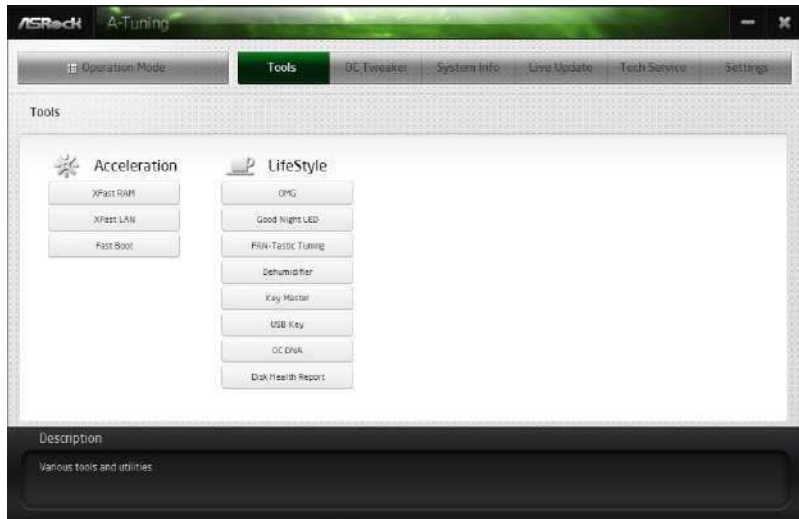

### **XFast RAM**

Boost the system's performance and extend the HDD's or SSD's lifespan! Create a hidden partition, then assign which files should be stored in the RAM drive.

### **XFast LAN**

Boost the speed of your internet connection! Select a specific mode for making the designated program's priority highest.

### **Fast Boot**

Fast Boot minimizes your computer's boot time. Please note that Ultra Fast mode is only supported by Windows 8.1/8 and the VBIOS must support UEFI GOP if you are using an external graphics card.

### **OMG**

Schedule the starting and ending hours of Internet access granted to other users. Place X marks on the time table to disable the Internet.

### **Good Night LED**

Switch off the Power/HDD LEDs when the system is on, and automatically switch off the Power and Keyboard LEDs when the system enters into Standby/Hibernation mode.

### **FAN-Tastic Tuning**

Configure up to five different fan speeds using the graph. The fans will automatically shift to the next speed level when the assigned temperature is met.

### **Dehumidifier**

Prevent motherboard damages due to dampness. Enable this function and configure the period of time until the computer powers on, and the duration of the dehumidifying process.

### **USB Key**

Plug in the USB Key and let your computer log in to windows automatically!

### **OC DNA**

OC DNA is an unique software which helps to save your OC settings as a profile. Then you can send this OC setting profile to the friends.

### **HDD Saver**

A quick-and-easy way to power up and down the drive on demand. Use a customized hotkey (Ctrl + Alt + S, by default) or simply slide to turn on and off up to two internal SATA HDDs connected to the power supply connector. Also a password can be set to change HDD power mode for more privacy and safety.

### **Disk Health Report**

Disk Health Report is a hard disk health monitoring utility that displays detailed HDD information, such as hard disk model, serial number, firmware, power on count, power on hours, S.M.A.R.T. values, current temperature, etc. HDD, SSD and optical disk drives are all supported. The health status block displays Good (in green color), Caution (in yellow color) or Bad (in red color). Click on the health status icon to configure settings for an alert to be triggered.

## OC Tweaker

Configurations for overlocking the system.

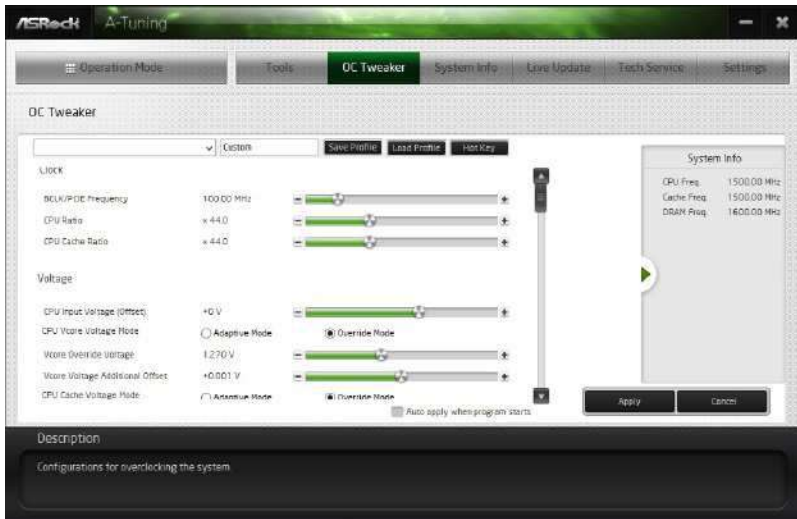

## System Info

View information about the system.

\*The System Browser tab may not appear for certain models.

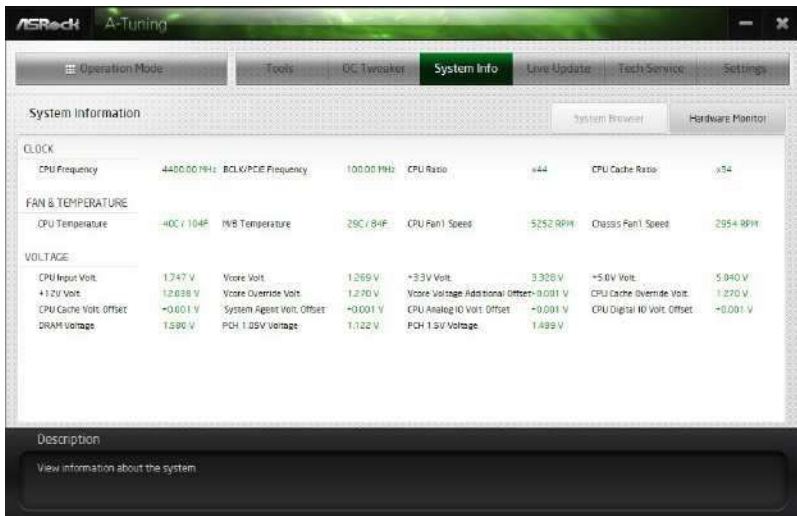

## Live Update

Check for newer versions of BIOS or drivers.

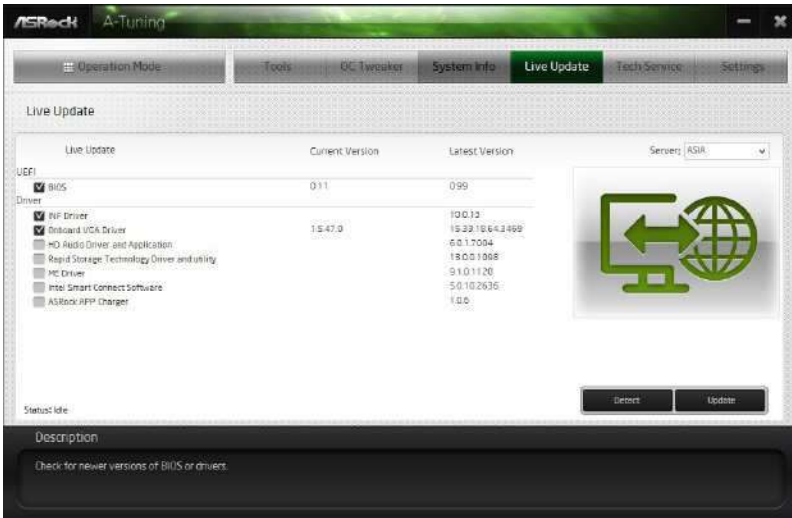

## Tech Service

Contact Tech Service if you have problems with your computer. Please leave your contact information along with details of the problem.

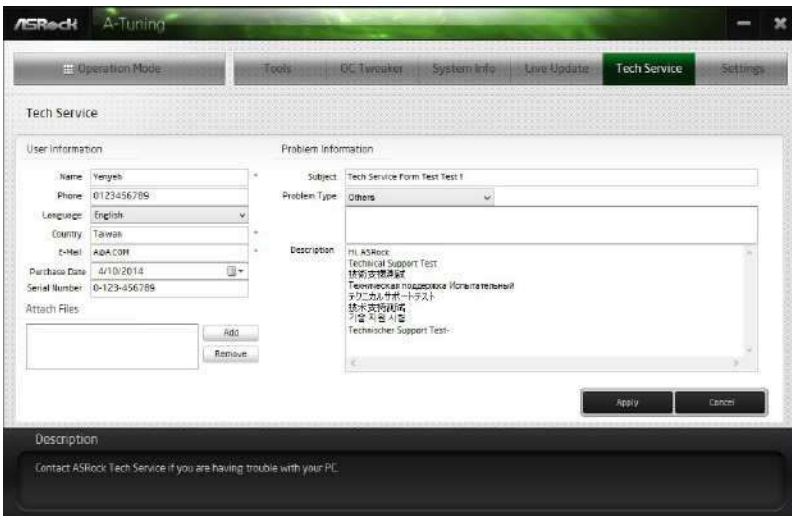

## Settings

Configure ASRock A-Tuning. Click to select "Auto run at Windows Startup" if you want A-Tuning to be launched when you start up the Windows operating system.

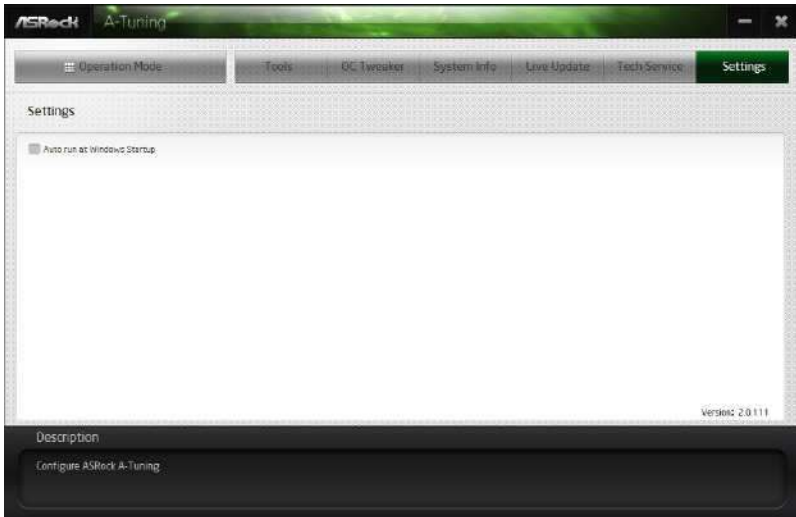

### 3.3 ASRock APP Shop

The ASRock APP Shop is an online store for purchasing and downloading software applications for your ASRock computer. You can install various apps and support utilities quickly and easily, and optimize your system and keep your motherboard up to date simply with a few clicks.

Double-click  on your desktop to access ASRock APP Shop utility.

*\*You need to be connected to the Internet to download apps from the ASRock APP Shop.*

#### 3.3.1 UI Overview

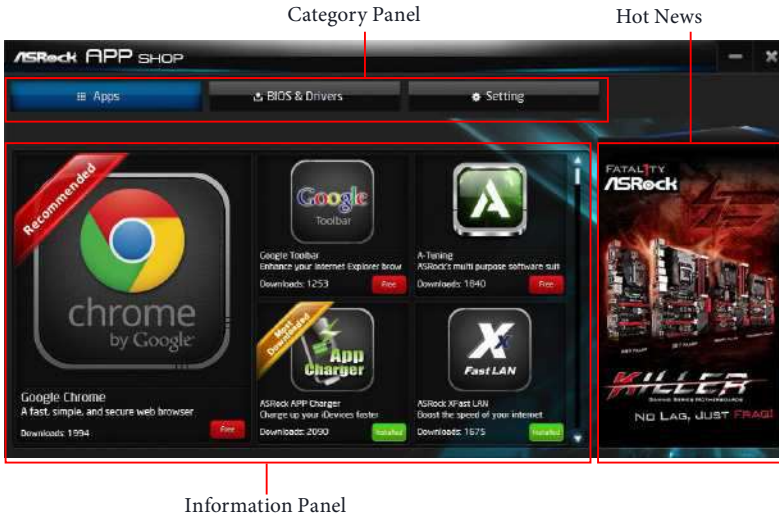

**Category Panel:** The category panel contains several category tabs or buttons that when selected the information panel below displays the relative information.

**Information Panel:** The information panel in the center displays data about the currently selected category and allows users to perform job-related tasks.

**Hot News:** The hot news section displays the various latest news. Click on the image to visit the website of the selected news and know more.

### 3.3.2 Apps

When the "Apps" tab is selected, you will see all the available apps on screen for you to download.

#### Installing an App

##### Step 1

Find the app you want to install.



The most recommended app appears on the left side of the screen. The other various apps are shown on the right. Please scroll up and down to see more apps listed.

You can check the price of the app and whether you have already installed it or not.

**Free** - The red icon displays the price or "Free" if the app is free of charge.

**Installed** - The green "Installed" icon means the app is installed on your computer.

##### Step 2

Click on the app icon to see more details about the selected app.



### Step 3

If you want to install the app, click on the red icon  to start downloading.



### Step 4

When installation completes, you can find the green "Installed" icon appears on the upper right corner.



To uninstall it, simply click on the trash can icon .  
\*The trash icon may not appear for certain apps.

## Upgrading an App

You can only upgrade the apps you have already installed. When there is an available new version for your app, you will find the mark of "New Version"  appears below the installed app icon.



### Step 1

Click on the app icon to see more details.

### Step 2

Click on the yellow icon  to start upgrading.

### 3.3.3 BIOS & Drivers

#### Installing BIOS or Drivers

When the "BIOS & Drivers" tab is selected, you will see a list of recommended or critical updates for the BIOS or drivers. Please update them all soon.

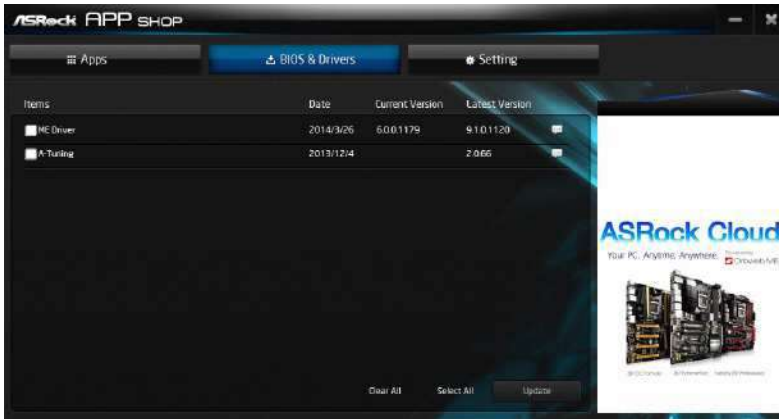

#### Step 1

Please check the item information before update. Click on  to see more details.

#### Step 2

Click to select one or more items you want to update.

#### Step 3

Click Update to start the update process.

### 3.3.4 Setting

In the "Setting" page, you can change the language, select the server location, and determine if you want to automatically run the ASRock APP Shop on Windows startup.



## 3.4 Start8

For those Windows 8 users who miss the Start Menu, Start8 is an ideal solution that brings back the familiar Start Menu along with added customizations for greater efficiency.

### 3.4.1 Installing Start8

Install **Start8**, which is located in the folder at the following path of the Support CD:  
 \ **ASRock Utility** > **Start8**.

### 3.4.2 Configuring Start8

#### Style

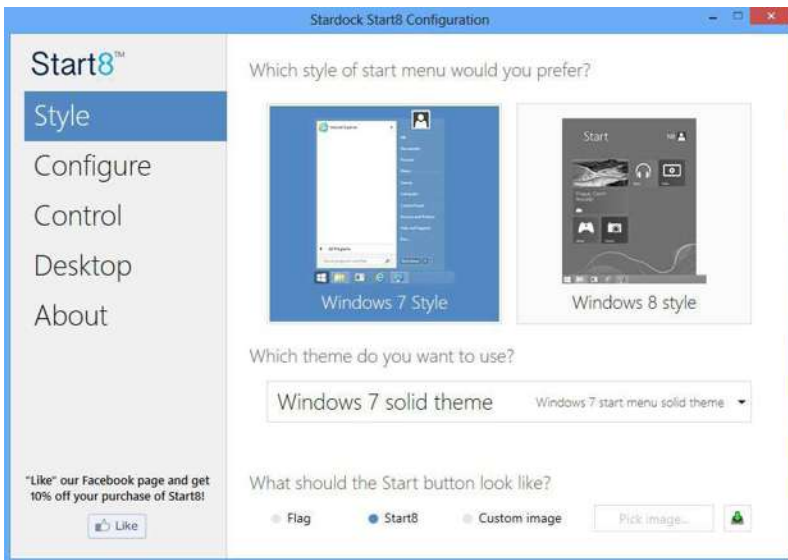

Select between the Windows 7 style and Windows 8 style Start Menu. Then select the theme of the Start Menu and customize the style of the Start icon.

## Configure

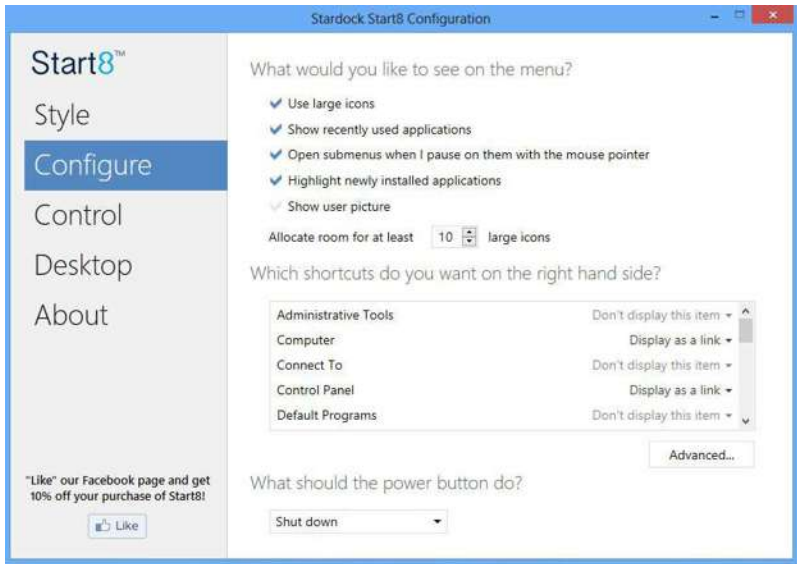

**Configure** provides configuration options, including icon sizes, which shortcuts you want Start Menu to display, quick access to recently used apps, the functionality of the power button, and more.

## Control

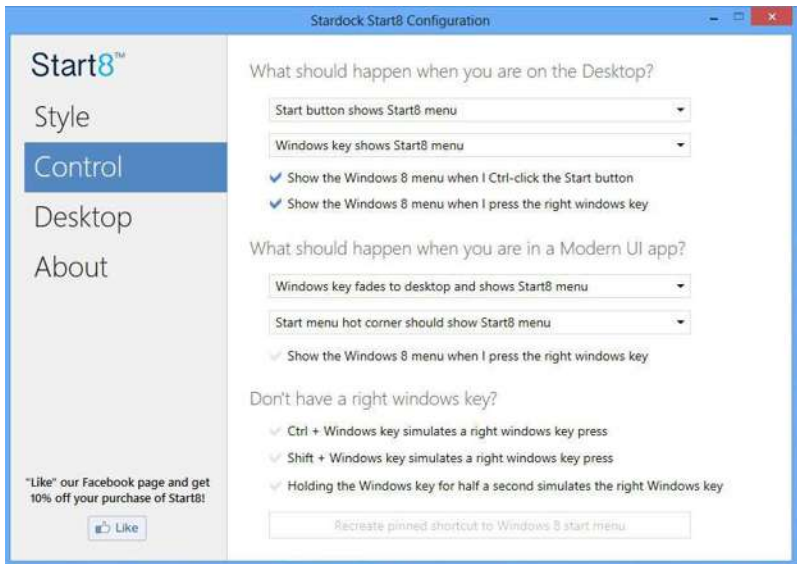

Control lets you configure what a click on the start button or a press on the Windows key does.

## Desktop

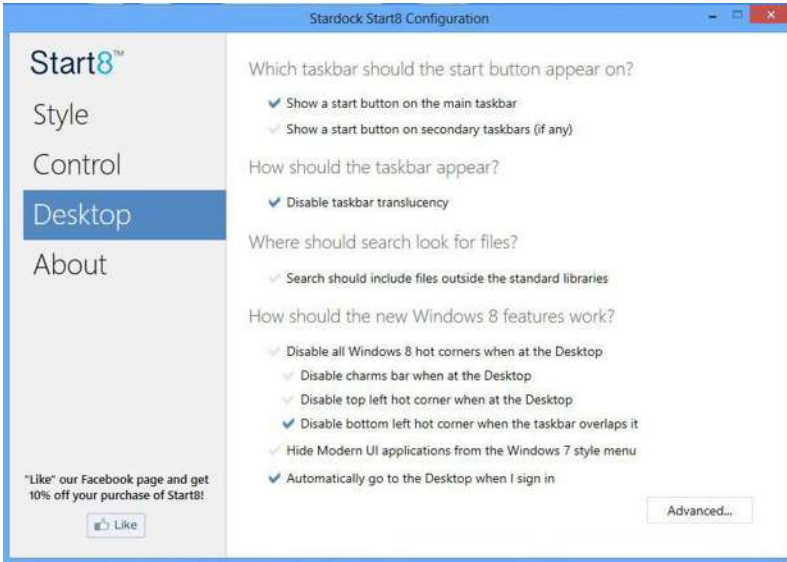

Desktop allows you to disable the hot corners when you are working on the desktop. It also lets you choose whether or not the system boots directly into desktop mode and bypass the Metro user interface.

## About

Displays information about Start8.

# Chapter 4 UEFI SETUP UTILITY

## 4.1 Introduction

This section explains how to use the UEFI SETUP UTILITY to configure your system. You may run the UEFI SETUP UTILITY by pressing <F2> or <Del> right after you power on the computer, otherwise, the Power-On-Self-Test (POST) will continue with its test routines. If you wish to enter the UEFI SETUP UTILITY after POST, restart the system by pressing <Ctl> + <Alt> + <Delete>, or by pressing the reset button on the system chassis. You may also restart by turning the system off and then back on.



*Because the UEFI software is constantly being updated, the following UEFI setup screens and descriptions are for reference purpose only, and they may not exactly match what you see on your screen.*

### 4.1.1 UEFI Menu Bar

The top of the screen has a menu bar with the following selections:

<b>Main</b>	For setting system time/date information
<b>OC Tweaker</b>	For overclocking configurations
<b>Advanced</b>	For advanced system configurations
<b>Tool</b>	Useful tools
<b>H/W Monitor</b>	Displays current hardware status
<b>Boot</b>	For configuring boot settings and boot priority
<b>Security</b>	For security settings
<b>Exit</b>	Exit the current screen or the UEFI Setup Utility



## 4.1.2 Navigation Keys

Use <←> key or <→> key to choose among the selections on the menu bar, and use <↑> key or <↓> key to move the cursor up or down to select items, then press <Enter> to get into the sub screen. You can also use the mouse to click your required item.

Please check the following table for the descriptions of each navigation key.

Navigation Key(s)	Description
+ / -	To change option for the selected items
<Tab>	Switch to next function
<PGUP>	Go to the previous page
<PGDN>	Go to the next page
<HOME>	Go to the top of the screen
<END>	Go to the bottom of the screen
<F1>	To display the General Help Screen
<F5>	Add / Remove Favorite
<F7>	Discard changes and exit the SETUP UTILITY
<F9>	Load optimal default values for all the settings
<F10>	Save changes and exit the SETUP UTILITY
<F12>	Print screen
<ESC>	Jump to the Exit Screen or exit the current screen

## 4.2 Main Screen

When you enter the UEFI SETUP UTILITY, the Main screen will appear and display the system overview.



### My Favorite

Display your collection of BIOS items. Press F5 to add/remove your favorite items.

## 4.3 OC Tweaker Screen

In the OC Tweaker screen, you can set up overclocking features.



*Because the UEFI software is constantly being updated, the following UEFI setup screens and descriptions are for reference purpose only, and they may not exactly match what you see on your screen.*

### Load 4GHz and XMP OC Setting

You can use this option to load 4GHz and XMP overclocking setting. Please note that overclocking may cause damage to your CPU and motherboard. It should be done at your own risk and expense.

### Load Optimized CPU OC Setting

You can use this option to load optimized CPU overclocking setting. Please note that overclocking may cause damage to your CPU and motherboard. It should be done at your own risk and expense.

### Multi Core Enhancement

Improve the system's performance by forcing the CPU to perform the highest frequency on all CPU cores simultaneously. Disable to reduce power consumption.

## CPU Configuration

### CPU Ratio

The CPU speed is determined by the CPU Ratio multiplied with the BCLK. Increasing the CPU Ratio will increase the internal CPU clock speed without affecting the clock speed of other components.

### CPU Cache Ratio

The CPU Internal Bus Speed Ratio. The maximum should be the same as the CPU Ratio.

### BCLK Frequency

The CPU speed is determined by the CPU Ratio multiplied with the BCLK. Increasing the BCLK will increase the internal CPU clock speed but also affect the clock speed of other components.

### BCLK/PCIE Ratio

Configure BCLK Ratio to prevent the PC from crashing when the internal CPU clock speed and clock speed of other components are too high.

### Spread Spectrum

Enable Spread Spectrum to reduce electromagnetic interference for passing EMI tests. Disable to achieve higher clock speeds when overclocking.

### SB Spread Spectrum

Enable SB Spread Spectrum to reduce electromagnetic interference for passing EMI tests. Disable to achieve higher clock speeds when overclocking.

### Intel SpeedStep Technology

Intel SpeedStep technology allows processors to switch between multiple frequencies and voltage points for better power saving and heat dissipation.

### Intel Turbo Boost Technology

Intel Turbo Boost Technology enables the processor to run above its base operating frequency when the operating system requests the highest performance state.

### Filter PLL Frequency

CPU BCLK Filter Frequency. Choose 1.6 for better overclocking capabilities.

## Long Duration Power Limit

Configure Package Power Limit 1 in watts. When the limit is exceeded, the CPU ratio will be lowered after a period of time. A lower limit can protect the CPU and save power, while a higher limit may improve performance.

## Long Duration Maintained

Configure the period of time until the CPU ratio is lowered when the Long Duration Power Limit is exceeded.

## Short Duration Power Limit

Configure Package Power Limit 2 in watts. When the limit is exceeded, the CPU ratio will be lowered immediately. A lower limit can protect the CPU and save power, while a higher limit may improve performance.

## Primary Plane Current Limit

Configure the current limit of the CPU under Turbo Mode in ampere. A lower limit can protect the CPU and save power, while a higher limit may improve performance.

## CPU Tj Max

Set CPU Tj Max to adjust TCC Target Temperature. Default setting is 105°C.

## DRAM Configuration

### DRAM Tweaker

Fine tune the DRAM settings by leaving marks in checkboxes. Click OK to confirm and apply your new settings.

### DRAM Timing Configuration

### Load XMP Setting

Load XMP settings to overclock the DDR3 memory and perform beyond standard specifications.

### BCLK Frequency

The CPU speed is determined by the CPU Ratio multiplied with the BCLK. Increasing the BCLK will increase the internal CPU clock speed but also affect the clock speed of other components.

## DRAM Voltage

Use this to configure DRAM Voltage. The default value is [Auto].

## DRAM Reference Clock

Select Auto for optimized settings.

## DRAM Frequency

If [Auto] is selected, the motherboard will detect the memory module(s) inserted and assign the appropriate frequency automatically.

## DRAM Frequency OC Preset

If the DRAM frequency is selected, the corresponding DRAM and BCLK frequency for overclocking will be set.

## Primary Timing

### CAS# Latency (tCL)

The time between sending a column address to the memory and the beginning of the data in response.

### RAS# to CAS# Delay (tRCD)

The number of clock cycles required between the opening of a row of memory and accessing columns within it.

### Row Precharge Time (tRP)

The number of clock cycles required between the issuing of the precharge command and opening the next row.

### RAS# Active Time (tRAS)

The number of clock cycles required between a bank active command and issuing the precharge command.

### Command Rate (CR)

The delay between when a memory chip is selected and when the first active command can be issued.

## Secondary Timing

### Write Recovery Time (tWR)

The amount of delay that must elapse after the completion of a valid write operation, before an active bank can be precharged.

**Refresh Cycle Time (tRFC)**

The number of clocks from a Refresh command until the first Activate command to the same rank.

**RAS to RAS Delay (tRRD)**

The number of clocks between two rows activated in different banks of the same rank.

**RAS to RAS Delay (tRRD\_L)**

The number of clocks between two rows activated in different banks of the same rank.

**Write to Read Delay (tWTR)**

The number of clocks between the last valid write operation and the next read command to the same internal bank.

**Write to Read Delay (tWTR\_L)**

The number of clocks between the last valid write operation and the next read command to the same internal bank.

**Read to Precharge (tRTP)**

The number of clocks that are inserted between a read command to a row pre-charge command to the same rank.

**Four Activate Window (tFAW)**

The time window in which four activates are allowed the same rank.

**CAS Write Latency (tCWL)**

Configure CAS Write Latency.

**Third Timing****tREFI**

Configure refresh cycles at an average periodic interval.

**tCKE**

Configure the period of time the DDR4 initiates a minimum of one refresh command internally once it enters Self-Refresh mode.

**tCCCD**

Configure back to back CAS to CAS (i.e. READ to RAED or WRITE to WRITE) from same rank separation parameter.

### **tCCCD\_L**

Configure back to back CAS to CAS (i.e. READ to RAED or WRITE to WRITE) from same rank separation parameter.

### **tCCCD\_WR\_L**

Configure back to back CAS to CAS (i.e. READ to RAED or WRITE to WRITE) from same rank separation parameter.

### **tRWSR**

Configure READ to WRITE same rank dead cycle Back to back READ to WRITE from same rank separation parameter.

### **tRWDD**

Configure Read to Write different DIMM dead cycle Back to back READ to WRITE from different DIMM separation parameter.

### **tRWDR**

Configure Read to Write different rank dead cycle Back to back READ to WRITE from different rank separation parameter.

### **tWRDD**

Configure Write to Read different DIMM dead cycle Back to back READ to WRITE from different DIMM separation parameter.

### **tWRDR**

Configure Write to Read different rank dead cycle Back to back READ to WRITE from different rank separation parameter.

### **tWWDD**

Configure Write to Write different DIMM dead cycle Back to back READ to WRITE from different DIMM separation parameter.

### **tWWDR**

Configure Write to Write different rank dead cycle Back to back READ to WRITE from different rank separation parameter.

### **tRRDD**

Configure Read to Read different DIMM dead cycle Back to back READ to WRITE from different DIMM separation parameter.



## tRRDR

Configure Read to Read different rank dead cycle Back to back READ to WRITE from different DIMM separation parameter.

### Advanced Setting

#### ODT WR (CH A)

Configure the memory on die termination resistors' WR for channel A.

#### ODT PARK (CH A)

Configure the memory on die termination resistors' PARK for channel A.

#### ODT NOM (CH A)

Use this to change ODT (CH A) Auto/Manual settings. The default is [Auto].

#### ODT WR (CH B)

Configure the memory on die termination resistors' WR for channel B.

#### ODT PARK (CH B)

Configure the memory on die termination resistors' PARK for channel B.

#### ODT NOM (CH B)

Use this to change ODT (CH B) Auto/Manual settings. The default is [Auto].

#### ODT WR (CH C)

Configure the memory on die termination resistors' WR for channel C.

#### ODT PARK (CH C)

Configure the memory on die termination resistors' PARK for channel C.

#### ODT NOM (CH C)

Use this to change ODT (CH C) Auto/Manual settings. The default is [Auto].

#### ODT WR (CH D)

Configure the memory on die termination resistors' WR for channel D.

#### ODT PARK (CH D)

Configure the memory on die termination resistors' PARK for channel D.

#### ODT NOM (CH D)

Use this to change ODT (CH D) Auto/Manual settings. The default is [Auto].

## MRC Fast Boot

Enable Memory Fast Boot to skip DRAM memory training for booting faster.

## Memory Test

Enable/disable memory test during normal boot.

## Memory Test On Fast Boot

Enable/disable memory test during fast boot.

## Memory Power Savings Mode

Configure CKE and related memory power savings features.

## Maximum Aggregate Memory Performance

Configure the maximum aggregate memory performance.

## FIVR Configuration

### CPU Vcore Voltage Mode

Auto: For optimized settings.

Override: The voltage is fixed.

### Vcore Voltage Additional Offset

Configure the dynamic Vcore voltage added to the Vcore.

### CPU Cache Voltage Mode

Auto: For optimized settings.

Adaptive: Add voltage to the CPU Cache when the system is under heavy loading.

Override: The voltage is fixed.

### CPU Cache Voltage Offset

Configure the voltage for the CPU Cache. Setting the voltage higher may increase system stability when overclocking.

### System Agent Voltage Offset

Configure the voltage for the System Agent. Setting the voltage higher may increase system stability when overclocking.

### CPU Integrated VR Faults

Disable FIVR Faults to raise the threshold to trigger CPU over current protection and over voltage protection for better overclocking capabilities.

## CPU Integrated VR Efficiency Mode

Enable FIVR Efficiency Management for power saving. Disable for better performance and overclocking capabilities.

## Voltage Configuration

### Power Saving Mode

Enable Power Saving Mode to reduce power consumption.

### CPU Input Voltage

Configure the voltage for the CPU.

### CPU Load-Line Calibration

CPU Load-Line Calibration helps prevent CPU voltage droop when the system is under heavy load.

### DRAM Voltage

Use this to configure DRAM Voltage. The default value is [Auto].

### DRAM Activating Power Supply

Configure the voltage for the DRAM Activating Power Supply.

### PCH PLL Voltage

Configure the chipset 1.5V voltage. Use default settings for best performance.

### CPU I/O Voltage

Configure the voltage for the CPU IO voltage supply unit.

### ME Voltage

Configure the ME voltage.

### PCH Voltage

Configure the PCH voltage.

### Save User Default

Type a profile name and press enter to save your settings as user default.

### Load User Default

Load previously saved user defaults.

## 4.4 Advanced Screen

In this section, you may set the configurations for the following items: CPU Configuration, Chipset Configuration, Storage Configuration, Super IO Configuration, ACPI Configuration, USB Configuration and Trusted Computing.



### Active Page on Entry

Select the default page when entering the UEFI setup utility.

### Full HD UEFI

When [Auto] is selected, the resolution will be set to 1920 x 1080 if the monitor supports Full HD resolution. If the monitor does not support Full HD resolution, then the resolution will be set to 1024 x 768. When [Disable] is selected, the resolution will be set to 1024 x 768 directly.



*Setting wrong values in this section may cause the system to malfunction.*

## 4.4.1 CPU Configuration



### Intel Hyper-Threading Technology

Intel Hyper-Threading Technology allows multiple threads to run on each core, so that the overall performance on threaded software is improved.

### Active Processor Cores

Select the number of cores to enable in each processor package.

### No-Execute Memory Protection

Processors with No-Execution Memory Protection Technology may prevent certain classes of malicious buffer overflow attacks.

### Hardware Prefetcher

Automatically prefetch data and code for the processor. Enable for better performance.

### Adjacent Cache Line Prefetch

Automatically prefetch the subsequent cache line while retrieving the currently requested cache line. Enable for better performance.

### Intel Virtualization Technology

Intel Virtualization Technology allows a platform to run multiple operating systems and applications in independent partitions, so that one computer system can function as multiple virtual systems.

---

## CPU Thermal Throttling

Enable CPU internal thermal control mechanisms to keep the CPU from overheating.

## CPU C States Support

Enable CPU C States Support for power saving. It is recommended to keep C3, C6 and C7 all enabled for better power saving.

## Package C State Support

Enable CPU, PCIe, Memory, Graphics C State Support for power saving.

## CPU C3 State Support

Enable C3 sleep state for lower power consumption.

## CPU C6 State Support

Enable C6 deep sleep state for lower power consumption.

## Enhanced Halt State (C1E)

Enable Enhanced Halt State (C1E) for lower power consumption.

## 4.4.2 Chipset Configuration



### Intel(R) Thunderbolt

Enable/Disable the Intel(R) Thunderbolt function.

### VT-d

Intel® Virtualization Technology for Directed I/O helps your virtual machine monitor better utilize hardware by improving application compatibility and reliability, and providing additional levels of manageability, security, isolation, and I/O performance.

### MCTP

Enable/disable the PCIe Management Component Transport Protocol.

### Above 4G Decoding

Enable/disable the 64-bit capable devices to be decoded in above 4G address space.

\*The function is only applied to system that supports 64-bit PCI decoding.

### SR-IOV Support

Enable/disable the SR-IOV (Single Root IO Virtualization Support) if the system has SR-IOV capable PCIe devices.

### PCI-E1 Link Speed

Select the link speed for PCI-E1.

## PCIE2 Link Speed

Select the link speed for PCIE2.

## PCIE3 Link Speed

Select the link speed for PCIE3.

## PCIE4 Link Speed

Select the link speed for PCIE4.

## PCIE5 Link Speed

Select the link speed for PCIE5.

## PCI-E ASPM Support

This option enables/disables the ASPM support for all CPU downstream devices

## PCH PCI-E ASPM Support

This option enables/disables the ASPM support for all PCH downstream devices

## PCH DMI ASPM Support

This option enables/disables the ASPM support for all PCH DMI devices.

## Intel® Smart Connect Technology

Intel® Smart Connect Technology automatically updates your email and social networks, such as Twitter, Facebook, etc. while the computer is in sleep mode.

## Onboard LAN

Enable or disable the onboard network interface controller.

## Onboard HD Audio

Enable/disable onboard HD audio. Set to Auto to enable onboard HD audio and automatically disable it when a sound card is installed.

## Front Panel

Enable/disable front panel HD audio.

## Deep Sleep

Configure deep sleep mode for power saving when the computer is shut down.



### Restore on AC/Power Loss

Select the power state after a power failure. If [Power Off] is selected, the power will remain off when the power recovers. If [Power On] is selected, the system will start to boot up when the power recovers.

### Good Night LED

By enabling Good Night LED, the Power/HDD LEDs will be switched off when the system is on. It will also automatically switch off the Power and Keyboard LEDs when the system enters into Standby/Hibernation mode.

## 4.4.3 Storage Configuration

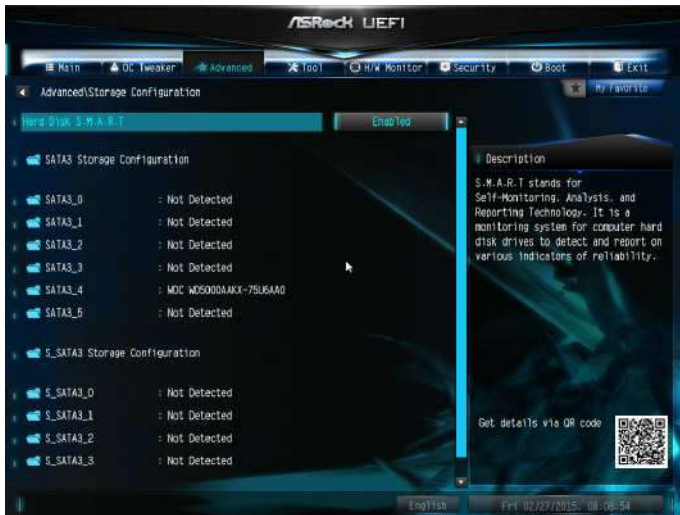

### Hard Disk S.M.A.R.T.

S.M.A.R.T stands for Self-Monitoring, Analysis, and Reporting Technology. It is a monitoring system for computer hard disk drives to detect and report on various indicators of reliability.

## 4.4.4 Super IO Configuration



### Serial Port

Enable or disable the Serial port.

### Serial Port Address

Select the address of the Serial port.

## 4.4.5 ACPI Configuration



### Suspend to RAM

Select disable for ACPI suspend type S1. It is recommended to select auto for ACPI S3 power saving.

### PS/2 Keyboard Power On

Allow the system to be waked up by a PS/2 Keyboard.

### Ring-In Power On

Allow the system to be waked up by onboard COM port modem Ring-In signals.

### RTC Alarm Power On

Allow the system to be waked up by the real time clock alarm. Set it to By OS to let it be handled by your operating system.

### USB Keyboard/Remote Power On

Allow the system to be waked up by an USB keyboard or remote controller.

### USB Mouse Power On

Allow the system to be waked up by an USB mouse.

### PCIE Devices Power On

Allow the system to be waked up by a PCIE device and enable wake on LAN.

## 4.4.6 USB Configuration



### USB Controller

Enable or disable all the USB ports.

### Intel USB 3.0 Mode

Select Intel® USB 3.0 controller mode. Set [Smart Auto] to keep the USB 3.0 driver enabled after rebooting (USB 3.0 is enabled in BIOS). Set [Auto] to automatically enable the USB 3.0 driver after entering the OS (USB 3.0 is disabled in BIOS). Set [Enabled] to keep the USB 3.0 driver enabled (Must install driver to use USB devices under Windows® 7). Set [Disabled] to disable the USB 3.0 ports.

### Legacy USB Support

Enable or disable Legacy OS Support for USB 2.0 devices. If you encounter USB compatibility issues it is recommended to disable legacy USB support. Select UEFI Setup Only to support USB devices under the UEFI setup and Windows/Linux operating systems only.

### Legacy USB 3.0 Support

Enable or disable Legacy OS Support for USB 3.0 devices. If you encounter USB compatibility issues it is recommended to disable legacy USB support. Select UEFI Setup Only to support USB devices under the UEFI setup and Windows/Linux operating systems only.

---

## USB Compatibility Patch

If your USB devices (i.e. USB mouse or storage) encounter compatibility problems, please enable this option to fix it. Please note that after enabling this option, it is normal that the system will postpone booting up after pressing the power button.

## 4.4.7 Trusted Computing



### Security Device Support

Enable or disable BIOS support for security device.

## 4.5 Tools



### System Browser

ASRock System Browser shows the overview of your current PC and the devices connected.

### OMG (Online Management Guard)

Administrators are able to establish an internet curfew or restrict internet access at specified times via OMG. You may schedule the starting and ending hours of internet access granted to other users. In order to prevent users from bypassing OMG, guest accounts without permission to modify the system time are required.

### Dehumidifier Function

If Dehumidifier Function is enabled, the computer will power on automatically to dehumidify the system after entering S4/S5 state.

### Dehumidifier Period

Configure the period of time until the computer powers on and enables Dehumidifier after entering S4/S5 state.

### Dehumidifier Duration

Configure the duration of the dehumidifying process before it returns to S4/S5 state.



## Dehumidifier CPU Fan Setting

Configure the speed of the CPU fan while Dehumidifier is enabled. The higher the value, the faster the fan speed.

Max: 255

Min: 1

## HDD Saver

By connecting your HDDs to the onboard SATA power connector with our special designed power cable, you can switch these HDDs on and off when needed. This design allows you to protect your privacy, save more energy, and prolong your HDDs' life spans.

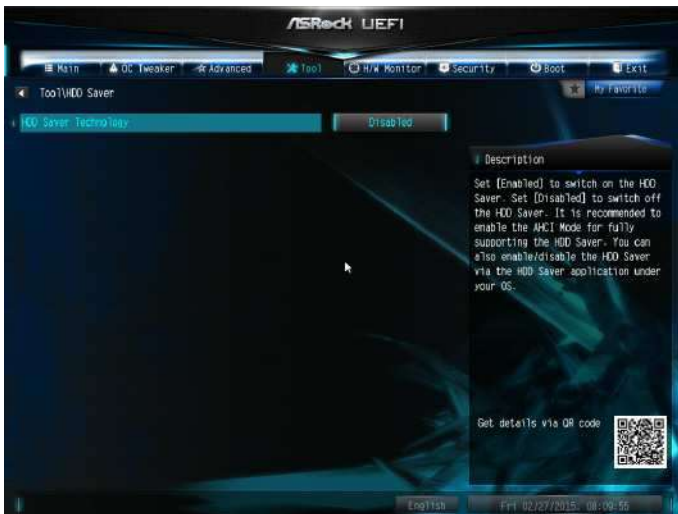

## HDD Saver Technology

Set [Enabled] to switch on the HDD Saver. Set [Disabled] to switch off the HDD Saver. It is recommended to enable the AHCI Mode to fully support the HDD Saver. You can also enable/disable the HDD Saver via the HDD Saver application under your OS.

## Onboard SATA Power Switch (SATA\_PWR\_1)

Set [Power On] to switch on the onboard SATA Power Connector. Set [Power Off] to switch off the onboard SATA Power Connector.

## Re-detect SATA Power Connection

Re-detect your SATA Power connection. It is recommended to proceed the re-detection for any changes of your HDD configuration. You can also proceed the re-detection via the HDD Saver application under your OS.

## Easy RAID Installer

Easy RAID Installer helps you to copy the RAID driver from the support CD to your USB storage device. After copying the drivers please change the SATA mode to RAID, then you can start installing the operating system in RAID mode.

## Easy Driver Installer

For users that don't have an optical disk drive to install the drivers from our support CD, Easy Driver Installer is a handy tool in the UEFI that installs the LAN driver to your system via an USB storage device, then downloads and installs the other required drivers automatically.

## UEFI Tech Service

Contact ASRock Tech Service if you are having trouble with your PC. Please setup network configuration before using UEFI Tech Service.

## Boot Manager

Boot Manager is specifically designed for the dual OS platform/multi-OS platform users to easily customize and manage the boot menu.

\*Please connect more than one boot devices to use this tool.

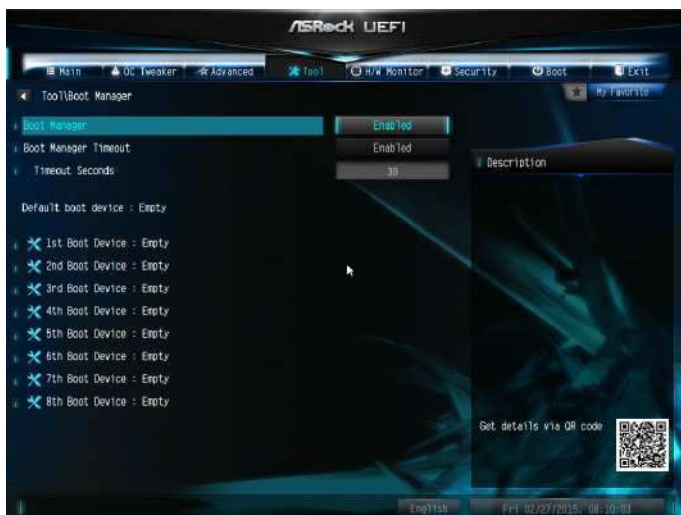

## Boot Manager

Enable/disable the Boot Manager.

## Boot Manager Timeout

Enable/disable the Boot Manager Timeout.

## Timeout Seconds

Configure the number of seconds to wait for the Boot Manager.

## Instant Flash

Save UEFI files in your USB storage device and run Instant Flash to update your UEFI.

## Internet Flash - DHCP (Auto IP), Auto

ASRock Internet Flash downloads and updates the latest UEFI firmware version from our servers for you. Please setup network configuration before using Internet Flash.

\*For BIOS backup and recovery purpose, it is recommended to plug in your USB pen drive before using this function.

## Secure Backup UEFI

Whenever one of the ROM images are outdated or corrupted, switch to the other flash ROM and execute Secure Backup UEFI to duplicate the current working ROM image to the secondary flash ROM.

## Network Configuration

Use this to configure internet connection settings for Internet Flash.

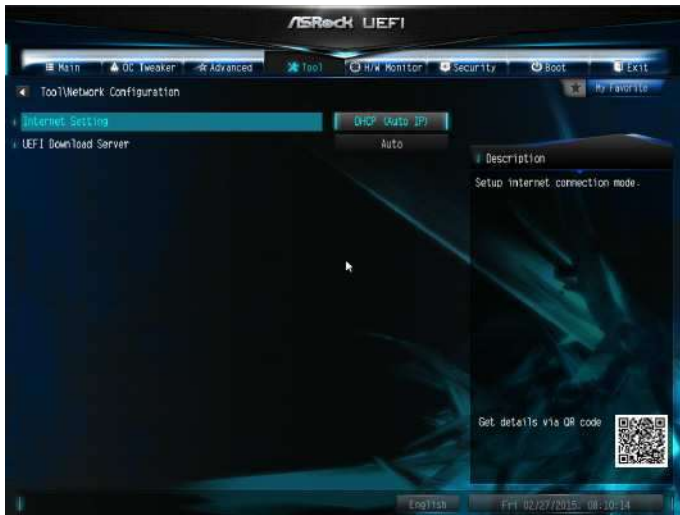

### Internet Setting

Enable or disable sound effects in the setup utility.

### UEFI Download Server

Select a server to download the UEFI firmware.

## 4.6 Hardware Health Event Monitoring Screen

This section allows you to monitor the status of the hardware on your system, including the parameters of the CPU temperature, motherboard temperature, fan speed and voltage.



### FAN-Tastic Tuning

Configure up to five different fan speeds using the graph. The fans will automatically shift to the next speed level when the assigned temperature is met.

### CPU Fan 1 & 2 Setting

Select a fan mode for CPU Fans 1&2, or choose Customize to set 5 CPU temperatures and assign a respective fan speed for each temperature.

### Chassis Fan 1 Setting

Select a fan mode for Chassis Fan 1, or choose Customize to set 5 CPU temperatures and assign a respective fan speed for each temperature.

### Chassis Fan 1 Temp Source

Select a fan temperature source for Chassis Fan 1.

### Chassis Fan 2 Setting

Select a fan mode for Chassis Fan 2, or choose Customize to set 5 CPU temperatures and assign a respective fan speed for each temperature.

---

### Chassis Fan 2 Temp Source

Select a fan temperature source for Chassis Fan 2.

### Chassis Fan 3 Setting

Select a fan mode for Chassis Fan 3, or choose Customize to set 5 CPU temperatures and assign a respective fan speed for each temperature.

### Chassis Fan 3 Temp Source

Select a fan temperature source for Chassis Fan 3.

### Over Temperature Protection

When Over Temperature Protection is enabled, the system automatically shuts down when the motherboard is overheated.

## 4.7 Security Screen

In this section you may set or change the supervisor/user password for the system. You may also clear the user password.



### Supervisor Password

Set or change the password for the administrator account. Only the administrator has authority to change the settings in the UEFI Setup Utility. Leave it blank and press enter to remove the password.

### User Password

Set or change the password for the user account. Users are unable to change the settings in the UEFI Setup Utility. Leave it blank and press enter to remove the password.

### Secure Boot

Use this item to enable or disable support for Windows 8.1/8 Secure Boot.

## 4.8 Boot Screen

This section displays the available devices on your system for you to configure the boot settings and the boot priority.



### Fast Boot

Fast Boot minimizes your computer's boot time. In fast mode you may not boot from an USB storage device. Ultra Fast mode is only supported by Windows 8.1/8 and the VBIOS must support UEFI GOP if you are using an external graphics card. Please notice that Ultra Fast mode will boot so fast that the only way to enter this UEFI Setup Utility is to Clear CMOS or run the Restart to UEFI utility in Windows.

### Boot From Onboard LAN

Allow the system to be waked up by the onboard LAN.

### Setup Prompt Timeout

Configure the number of seconds to wait for the setup hot key.

### Bootup Num-Lock

Select whether Num Lock should be turned on or off when the system boots up.

### Boot Beep

Select whether the Boot Beep should be turned on or off when the system boots up. Please note that a buzzer is needed.



## Full Screen Logo

Enable to display the boot logo or disable to show normal POST messages.

## AddOn ROM Display

Enable AddOn ROM Display to see the AddOn ROM messages or configure the AddOn ROM if you've enabled Full Screen Logo. Disable for faster boot speed.

## Boot Failure Guard

If the computer fails to boot for a number of times the system automatically restores the default settings.

## Boot Failure Guard Count

Configure the number of attempts to boot until the system automatically restores the default settings.

## CSM (Compatibility Support Module)



## CSM

Enable to launch the Compatibility Support Module. Please do not disable unless you're running a WHCK test. If you are using Windows 8.1/8 64-bit and all of your devices support UEFI, you may also disable CSM for faster boot speed.

## Launch PXE OpROM Policy

Select UEFI only to run those that support UEFI option ROM only. Select Legacy only to run those that support legacy option ROM only. Do not launch?

---

### Launch Storage OpROM Policy

Select UEFI only to run those that support UEFI option ROM only. Select Legacy only to run those that support legacy option ROM only. Do not launch?

### Launch Video OpROM Policy

Select UEFI only to run those that support UEFI option ROM only. Select Legacy only to run those that support legacy option ROM only. Do not launch?

## 4.9 Exit Screen



### Save Changes and Exit

When you select this option the following message, “Save configuration changes and exit setup?” will pop out. Select [OK] to save changes and exit the UEFI SETUP UTILITY.

### Discard Changes and Exit

When you select this option the following message, “Discard changes and exit setup?” will pop out. Select [OK] to exit the UEFI SETUP UTILITY without saving any changes.

### Discard Changes

When you select this option the following message, “Discard changes?” will pop out. Select [OK] to discard all changes.

### Load UEFI Defaults

Load UEFI default values for all options. The F9 key can be used for this operation.

### Launch EFI Shell from filesystem device

Copy shellx64.efi to the root directory to launch EFI Shell.

## Contact Information

If you need to contact ASRock or want to know more about ASRock, you're welcome to visit ASRock's website at <http://www.asrock.com>; or you may contact your dealer for further information. For technical questions, please submit a support request form at <http://www.asrock.com/support/tsd.asp>

### **ASRock Incorporation**

2F., No.37, Sec. 2, Jhongyang S. Rd., Beitou District,

Taipei City 112, Taiwan (R.O.C.)

### **ASRock EUROPE B.V.**

Bijsterhuizen 11-11

6546 AR Nijmegen

The Netherlands

Phone: +31-24-345-44-33

Fax: +31-24-345-44-38

### **ASRock America, Inc.**

13848 Magnolia Ave, Chino, CA91710

U.S.A.

Phone: +1-909-590-8308

Fax: +1-909-590-1026