

USER MANUAL

PFF-1514B

Before connecting, operating or adjusting this product, please read this user's manual carefully and completely.

If the user manual is not printed in your local language, then please enter our website to see if it is found online under the model you have. The website address is: denver.eu

ENGLISH

Important safety information

WARNING: Please read the safety instructions carefully before using the product for the first time and keep the instructions for future reference. Read all the safety information below before using this Frameo product.

1. This product is not a toy. Keep it out of reach of children. If operated by children, please always make adult supervision.
2. Please keep the product away from pets.
3. Warning this Frameo product is with lithium battery inside, so pls follow below:



Do not try to open the Frameo product! The device may contain parts with deadly voltage.

Do not expose to heat, water, moisture, direct sunlight!

Only charge with the original adapter supplied with this product!

Do not attempt to replace the inside battery yourself- you may damage the battery, which could cause overheating and injury. The lithium battery in the product should be replaced only by skilled engineer and must be recycled or disposed of separately from household waste. Do not incinerate the battery.

Repairs or service should only be performed by qualified personnel.

4. To reduce the risk of fire or electric shock, do not expose this apparatus to rain or moisture. The apparatus shall not be exposed to dripping or splashing and that objects filled with liquids, such as vases, shall not be placed on apparatus.
5. The direct plug-in adapter is used as disconnect device, the disconnect device shall remain readily operable. So make sure there is space around the power outlet for easy access.
6. Product operating and storage temperature is from -10 degree Celsius to 40 degree Celsius. Under and over this temperature might affect the function.

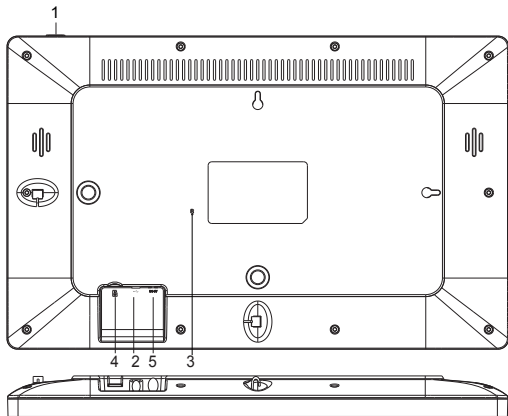

1. POWER

After connecting power adapter, please press and hold power button for approximately 5 seconds (until screen turns on).

When it is on, press and hold power button for approximately 3 seconds to access reboot or power off menu. Short press on power button will turn off/onscreen (but leave the photo frame in on position).

2. USB

Connect a USB flash drive. USB is for service use only.

3. RESET

Use a needle or paper clip to reset unit.

4. MicroSD card

Load external max 32GB microSD memory card here.

5. DC

Connect DC adapter to power on the device.



frameo

User Manual

Version: 1.10.4

Contents

Getting started	4
Frameo app	4
Frameo quick setup	5
Start using Frameo	6
Connecting a new friend	6
Navigating your Frameo	7
Settings	10
My frame	10
Manage photos	10
My Friends	11
Display	12
Slideshow	12
Wi-Fi	13
Notifications	14
Backup and Restore	15
Help	15
About	16
Privacy	17
Support	17
Warranty, Compliance, Support and Safety information	17

Getting started

Congratulations on your brand new Frameo photo frame!

If you are new to using Frameo then start by following the Frameo quick setup or follow the on-screen guide when powering it on for the first time.

Once you have set up your Frameo frame, you can start connecting it to your friends and family.

Frameo app

To send photos to your frame, use the Frameo app for iOS or Android.



Find the Frameo app by scanning this code:



For Android:

Search for "Frameo" on [Google Play](#).

For iOS:

Search for "Frameo" on [App Store](#).

Frameo quick setup

When starting your frame for the first time, you will need to set up the frame.

- Select a language. This will be the language used on the Frameo.
- Connect your frame to the internet by connecting it to Wi-Fi.
- Verify or correct the date and time.
- Frameo may ask you to update to the latest version. *It is recommended to update your frame before continuing if asked to.*
- Enter your name, and the location where you have placed your frame e.g. "John Doe" and "Living room", "Kitchen" or "Office". Finally set the timezone if not already correct.

Start using Frameo

Next step is to connect Frameo with your friends and family by providing them with a code from your frame.

If you want to be able to send photos to the frame yourself, start by downloading the app for iOS or Android on [App Store](#) or [Google Play](#). Then use the code to connect your frame and app as described below.

Connecting a new friend

Make sure that your friend has downloaded and installed the Frameo app.

Click the add friend icon on your frame . A dialog will appear showing a connection code, which is valid for 12 hours.

Now share this code in whatever fashion you prefer e.g. SMS, E-Mail, IM, phone call, to your friend.

Once your friends have added the code in their Frameo app, they will automatically appear on your frame and be able to send you photos.

Read chapter [Change options for a friend](#) to *allow* connected friends, to retrieve and share the connection code via the smartphone app.



Navigating your Frameo

Swipe left or right to go through your photos.

To access the menu, simply tap once on the screen.

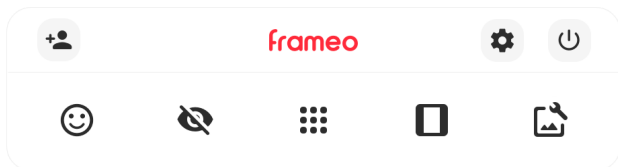

In the menu you will find the most used features.

Add friend

This will generate a code that you can share with your friends and family so they can connect and send photos to your frame.

Settings

Opens the [Settings](#).

Power menu

Opens the [Power menu](#).

React

Opens the [React menu](#).

NB. The React menu can also be accessed by double-tapping on the screen.

Hide photo

Hides the current photo. This means that the photo will no longer be shown in the slideshow. If needed the photo can be shown again through the [settings menu](#).

Gallery

Opens a gallery which allows for easy and fast navigation through your photos.

Fit to frame/Fill frame

This toggles how the photo is shown.

The *Fill frame* option is the default. The photo is scaled so that it fills the whole screen. It will be centered around what is selected as the most important part. See the first picture below.

Fit to frame will make sure that the entire photo is shown on the screen. See the second picture below.

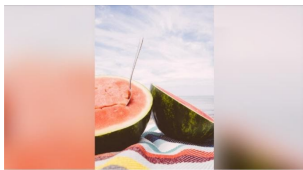

Adjust photo



Allows you to adjust the position of the photo in the frame for an even better fit. Here you can also use to rotate  your photo.

Interacting with videos

When a video is shown two additional controls are shown. One for play/pause of the video and one to control the volume level for video sounds.





Press  to start the video playback. Pressing  will pause the video playback.

Press  to open the volume slider. Use the slider to adjust the volume level for video sounds.

Pressing  will mute the video while pressing  will unmute the video.



Power menu

Tap the power icon  to access the power menu. Here you can power off using , restart your frame using  or enter sleep mode using .

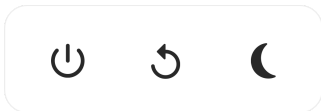

NB. Make sure to always use the power off button on the device or in the power menu to turn Frameo off. Never disconnect power when Frameo is running.

React menu

Tap one of the reactions to let the sender know how it made you feel.

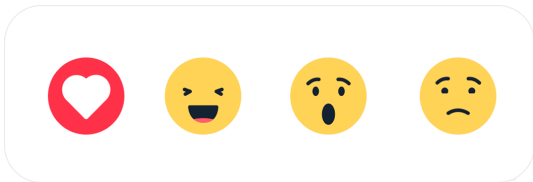

Settings

Through the settings, you can personalize your frame to your needs.

My frame

Frame name

Changes the name of your frame. This is also the name that connected friends and family will see in their list of connected frames in the smartphone app.

Frame location

Changes the location of your frame. This is the location displayed on your friends' and family's list of connected frames which can help to distinguish frames from each other.

Set language

Sets the language used on the frame.

Date

Sets the date used on the frame.

Time

Sets the time used on the frame.

Frameo will automatically try to set the correct date and time when connected to the internet.

Time zone

Sets the time zone used on the frame.

Enable/Disable 24-hour format

Enables, and disables, 24-hour time format.

Manage photos

In the manage photos menu you can see how many photos are on your frame and the storage they use. You can also see the amount of storage left available on your device for storing new photos.



Show/hide photos

Select which photos to hide by tapping them. Hidden photos will NOT be deleted from your frame and you can always select them to be shown again.

Use  to hide or show all photos.

Delete photos

Select photos that you want to permanently delete from your frame by tapping the photo.

Use  to select or deselect all and  to permanently delete the selected photos.



Import photos

Allows you to import photos from an external storage (e.g. microSD card).

Before you try to import photos, make sure you have an external storage (e.g. microSD card) inserted into your frame with the photos you wish to import.

Start by selecting the photos that you want to import onto your frame. Once selected tap the import button  to start the import process.

Use  to select or deselect all photos on the external storage (e.g. microSD card).

Use  to set the sort order of photos before import and  to order by ascending/descending.

It is currently not possible to add a caption or define the most important part of the photo when using the import function. An alternative for this is to add yourself to your friend list and send the photos using the app.

Export photos

Allows you to export photos from the frame to external storage (e.g. microSD card).

The export function will export all photos on the frame as well as profile pictures.

My Friends

This list contains all the connected friends that are allowed to send photos to your frame.

Change options for a friend

Click the options icon  to open the friend options menu. From here you can allow / disallow if a friend may share the code to the frame. If this is enabled the friend can retrieve and share the code to the frame from his/her app.

From the options menu you can also delete a friend, by pressing the DELETE FRIEND button. This will remove the friend from the list and thereby remove their permission to send photos to the frame. You will then be asked to confirm the removal and if you would like to remove all photos previously received from this friend.

Add person

To allow a new person to send you photos, simply tap the add friend button  and share the presented code in whatever way you prefer.

Display

Brightness level

Adjust the brightness level of the screen.

Sleep mode

Frameo offers a sleep mode which turns off the screen to reduce power consumption. The default setting is to turn off the screen at 23:00 and turn on the screen again at 07:00. To change this just set the sleep mode start/end time.

Your frame is not powered down or in standby, so you will still be able to receive photos during sleep mode.

Slideshow

Timer

Set the duration that a photo should be displayed before showing the next photo.

Show caption

Sets whether or not to display the captions that your friends have sent with the photo. Check to display captions. Uncheck to hide captions.

Fill frame

Sets the default frame photo setting. Check to set default to fill which makes the photos fit the device screen according to the most important part of the photo. Uncheck to make the photo fit inside the screen of the device, adding blurred bars on the sides or top/bottom

Photo display order

Sets the order in which your photos are displayed on the frame.

- By date taken: Photos are shown in order of when it was taken.
- By date received: Photos are shown in order of when it was received.
- Shuffle: Photos are shuffled and shown in a random order.

Reverse photo display order

Sets if photos are displayed newest to oldest or oldest to newest.

Autoplay

Enables/disables autoplay of videos in the slideshow. Videos can always be manually started regardless of this setting.

Video playback

Determines how videos should be played when autoplay is enabled.

- Loop videos: The video will loop until the slideshow timer is up.
- Play once: The video will play once and show its thumbnail until the timer is up.
- Play once and continue: The video will play once and continue to the next photo, or video, once it completes.

Video volume

Adjust the volume level for video sounds on the frames.

Wi-Fi

Set which Wi-Fi the frame connects to. If you are connecting to a network with a captive portal Connection status will say that Wi-Fi login is required and show . Tap this to open a login screen where you can enter credentials to access the network.

Wi-Fi details

Use  to show details about the current connected Wi-Fi.

Reset Wi-Fi

Use  to delete all Wi-Fi information and restart your frame.

Notifications

Show notifications

Enables/disables whether notifications are shown in the slideshow (e.g. when a new photo is received).

Notification volume

Adjust the volume level for notification sounds.

Storage space

Enables/disables notifications shown when frame storage is low.

Backup

Enables/disables notifications shown if automatic backup has failed.

Network connection

Enables/disables notifications showing network connection status.

New photos

Enables/disables notifications shown when receiving new photos.

New friends

Enables/disables notifications shown when new friends are added.

Software update

Enables/disables notifications shown when a software update has been installed.

Feature news

Enables/disables notifications shown when new exciting features are added.

Date and time

Enables/disables notifications shown if time or date is not set correctly.

Backup and Restore

Backup frame to external storage (e.g. microSD card)

Tap to make a backup of your photos, friends and settings. The time of the latest successful backup is also displayed here.

Any existing backup on the external storage will be overridden!

Automatic backup

If checked, your frame will automatically take a backup within 30 hours of receiving new photos or making changes to your frame.

Restore from backup

Before you attempt to restore your frame, start by confirming that your backup is up-to-date. This is done by confirming the date under “Backup frame to external storage (e.g. microSD card)”. If e.g. the last backup is too old or if no backup is made, then press the “Backup frame to external storage (e.g. microSD card)” button to make a new backup.

NB: To keep both the old and the new frame operational at the same time after restoring from backup, please make sure that both frames are updated to the latest version beforehand.

If you wish to restore a backup on a frame that has already been setup, then you must first reset the frame. This is done by pressing the “Reset frame” button. This will delete all data on the Frameo and reset the Frameo to its setup screen.

On the setup screen you can select the “Restore from backup” button which will restore your frame according to the backup.

If the “Restore from backup” button isn’t visible, then confirm that the external storage (e.g. microSD card) is correctly mounted.

Reset frame

Removes all data from your frame.

This will permanently remove all your photos, friends/connections and settings.

Help

Open source libraries

Opens a list of open source libraries used in the app and their licenses.

Share anonymous analytics data

Sharing anonymous analytics data helps us tremendously to improve the Frameo software. We understand if you do not wish to share this data with us. Keep it checked if you wish to help us improve Frameo. Set unchecked to deny the sharing of anonymous analytics data.

Guide

Opens the quick start guide, that was shown when you first started the frame.

About**Android version**

See what version of Android that is installed on the frame.

Peer ID

This is a unique ID for your photo frame. When contacting our support, please provide this ID with your message.

MAC

Shows the MAC address of your frame.

Frameo version

Shows what version of the Frameo software is currently installed on your frame.

Up time

Shows how long the photo frame has been powered on.

Check for update

Check if an update is available for your frame.

Beta program

If checked the device will join the Beta program where it will receive updates more frequently and before normal release devices.

Privacy

For more information regarding privacy, please visit <http://privacy.frameo.net>

Support

Please visit <https://support.frameo.net/hc> for FAQ, support and to provide feedback.

Warranty, Compliance, Support and Safety information

For more information regarding warranty, hardware compliances, support and safety please refer to the material included in the package.

Manufacturer's name or trade mark, commercial registration number and address	Shenzhen Run Sheng Feng Power Supply Technolgy Co., Ltd commercial registration number: 91440300580068676U 3 rd Floor, 4 th Building, Zone A Xinfu Industrial Park, Chongqing Road, Fuyong Street, Bao'an District, Shenzhen, China
Model identifier	RSF-DY077A-0503000EU
Input voltage	100-240V
Input AC frequency	50/60Hz
Output voltage	5V
Output current	3A
Output power	15W
Average active efficiency	82.42% at 115V 60Hz 82.08% at 230V 50Hz
Efficiency at low load (10%)	84.44% at 115V 60Hz 81.18% at 230V 50Hz
No-load power consumption	0.05W at 115V 60Hz 0.07W at 230V 50Hz

Please notice - All products are subject to change without any notice. We take reservations for errors and omissions in the manual.

ALL RIGHTS RESERVED, COPYRIGHT DENVER A/S



denver.eu



Electric and electronic equipment contains materials, components and substances that can be hazardous to your health and the environment, if the waste material (discarded electric and electronic equipment) is not handled correctly.

Electric and electronic equipment is marked with the crossed out trash can symbol, seen above. This symbol signifies that electric and electronic equipment should not be disposed of with other household waste, but should be disposed of separately.

All cities have established collection points, where electric and electronic equipment can either be submitted free of charge at recycling stations and other collection sites, or be collected from the households. Additional information is available at the technical department of your city.

Hereby, Denver A/S declares that the radio equipment type PFF-1514B is in compliance with Directive 2014/53/EU. The full text of the EU declaration of conformity is available at the following internet address: denver.eu and then click the search ICON on topline of website. Write model number: PFF-1514B. Now enter product page, and RED directive is found under downloads/other downloads.

Operating Frequency Range: 2412 -2472 MHz

Max Output Power: 17 dbm

DENVER A/S
Omega 5A, Soefften
DK-8382 Hinnerup
Denmark

www.facebook.com/denver.eu