



# ***D.F.12*** **REVOLUTION**

**750W / 850W**

# D.F.12 REVOLUTION



- Compact ATX PSU with Chassis Size 122mm in Depth
- ATX3.1 Ready with Native 600W 12V-2x6 Cable
- Up to 235% Power Excursion
- Dust-free Rotation Tech. with Switch Button
- Fully Modular 80 PLUS® GOLD Certified
- 100% Japanese Capacitors
- Semi-fanless Tech. for Absolute Silence under 50% Load

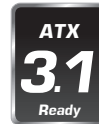

## Features

- **The Smallest ATX PSU**
  - Stands out as the most diminutive PSU available, boasting a mere 122mm depth chassis.
- **Compliance with ATX 3.1**
  - Native 12V-2x6 connector that channels up to 600W power for PCIe 5.0 graphics cards, ensuring top-notch performance.
  - Adherence to the latest Intel ATX 3.1 specification, guaranteeing compatibility with contemporary hardware configurations.
- **Excellent Performance Meeting High-End Requirements**
  - 80 PLUS® GOLD certified with 90% efficiency at 50% load, which saves more energy and reduces extra heat.
  - Accommodates up to 235% power excursion, catering to high-end GPU requirements.
- **Exclusive D.F.R. Function for Self-Cleaning**
  - Patented Dust-free Rotation(D.F.R.) function with auto-cleaning upon powering up, enhancing system longevity by minimizing dust accumulation.
  - Additional switch button to activate D.F.R. function flexibly.
- **Silent Operation and Enhanced Durability**
  - Features semi-fanless control, in which the fan stops operating when the power is under 50% load, optimizing noise levels during lower power demands.
  - Incorporates 100% industrial-grade Japanese capacitors, ensuring top-tier reliability.
  - Equipped with a built-in 115mm dual-ball bearing fan.
- **Outstanding User Experience**
  - Exquisite white version available with white modular cables for demanding system assembly.
  - Mesh sleeved cables for organized and aesthetically pleasing cable management.

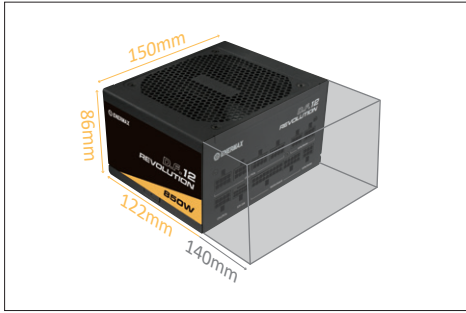

The World's Smallest ATX PSU with 122mm Chassis

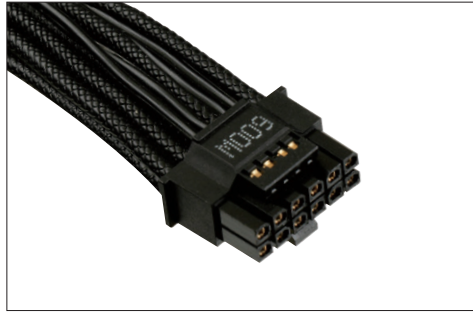

Native 12V-2x6 Cable

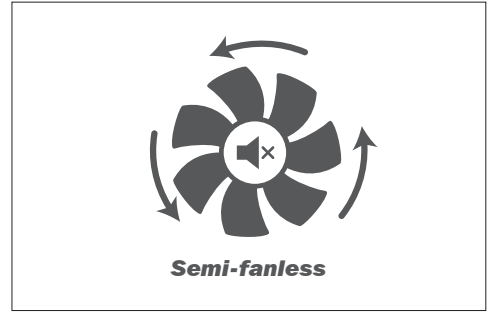

Semi-fanless under 50% Load

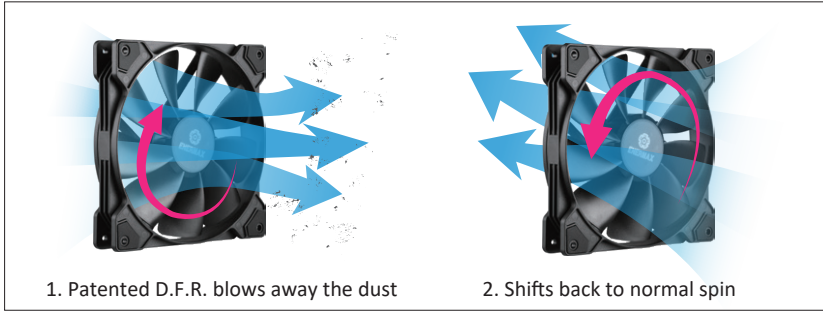

Dust-free Rotation(D.F.R.) Function



D.F. Switch Button

## Dimensions

Unit : mm

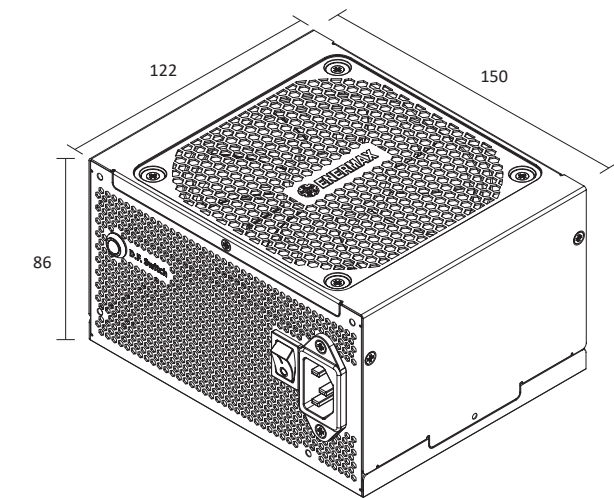

## Pinout Diagram- PSU Side

Perspective: Facing the modular sockets

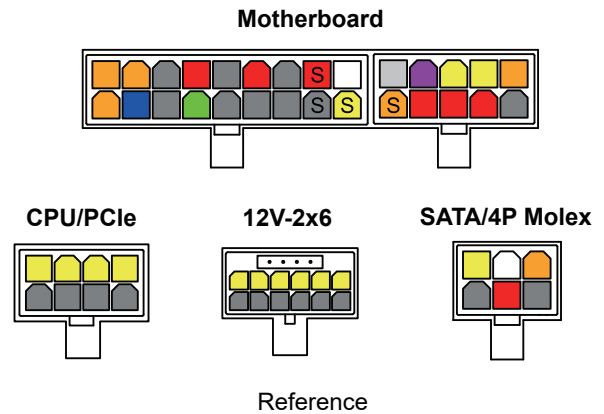

<span style="color: yellow;">■</span> +12V	<span style="color: red;">■</span> +5V	<span style="color: orange;">■</span> +3.3V	<span style="color: purple;">■</span> +5Vsb
<span style="color: blue;">■</span> -12V	<span style="color: green;">■</span> PS_ON	<span style="color: grey;">■</span> PWR_OK	<span style="color: darkgrey;">■</span> COM
S = Remote Sensing			

## Cables & Connectors

Product	Connectors					
750W	1	2	1	3	8	4
850W	1	2	1	3	8	4

# Specifications

## General Data

80 PLUS Efficiency	GOLD
Modular	Fully Modular
Cable Type	Mesh Sleeved Cable
Fan Size (mm)	115
Operating Temperature (°C)	50
MTBF (hrs)	>100K
Protections	OCP, OVP, UVP, OPP, OTP, SCP

## Power Table

Model	ETV750G / ETV750G-W		ETV850G / ETV850G-W	
AC Input Voltage	100-240VAC, 50-60Hz			
AC Input Current	10A			
DC Output				
	Rated	Combined	Rated	Combined
+3.3V	20A	100W	20A	100W
+5V	20A		20A	
+12V	62.4A	748.8W	70.8A	849.6W
-12V	0.4A	4.8W	0.4A	4.8W
+5Vsb	3A	15W	3A	15W
Total Power	750W		850W	
Dimensions	122(D) x 150(W) x 86(H) mm			



## Logistics Information

Model	ETV750G	ETV750G-W	ETV850G	ETV850G-W	
Barcode	EAN	4713157727916	4713157728012	4713157727923	4713157728029
	UPC	819315027912	819315028018	819315027929	819315028025
Package Dimensions	260(W) x 180(D) x 118(H) mm				
Gross Weight / Unit	2.30 kg				
Carton Dimensions	555(W) x 265(D) x 280(H) mm				
Q'ty / Carton	6 pcs				
Gross Weight / Carton	16.05 kg	16.03 kg	16.06 kg	16.04 kg	