

Connect to control board on BitFenix cases

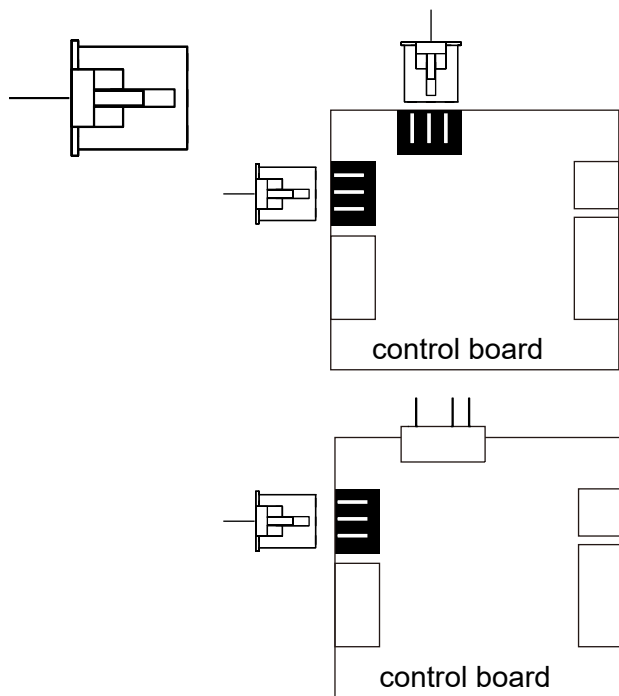

Daisy chain with BitFenix ARGB accessories

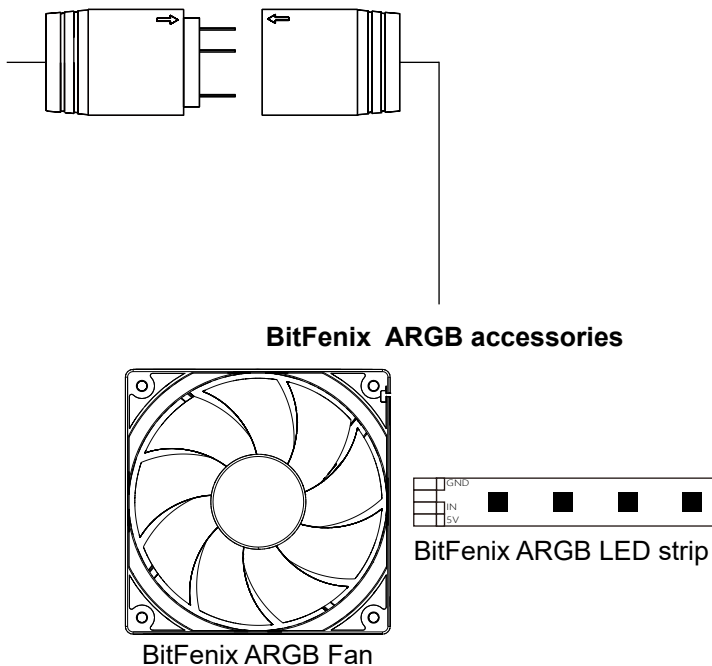

- Connect to ARGB LED connector on motherboard or control board on BitFenix cases with 3 pin ARGB LED connector

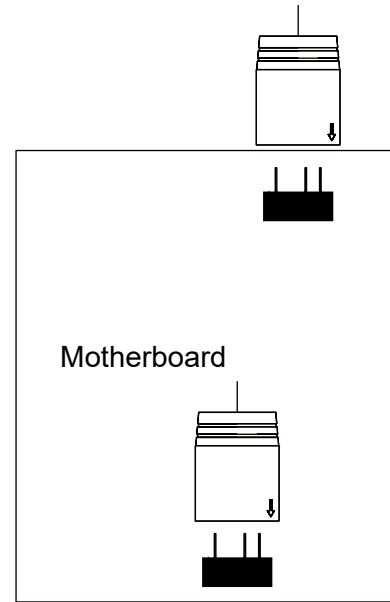
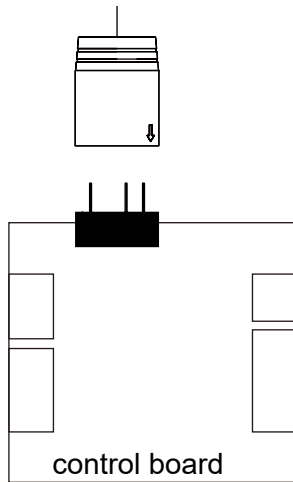
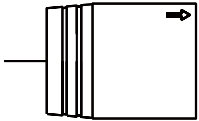

BitFenix ARGB LED strip



Connect to ARGB LED connector on motherboard or control board on BitFenix cases with 3 pin ARGB LED connector



Connect to control board on BitFenix cases



■ Connect to control board on BitFenix cases

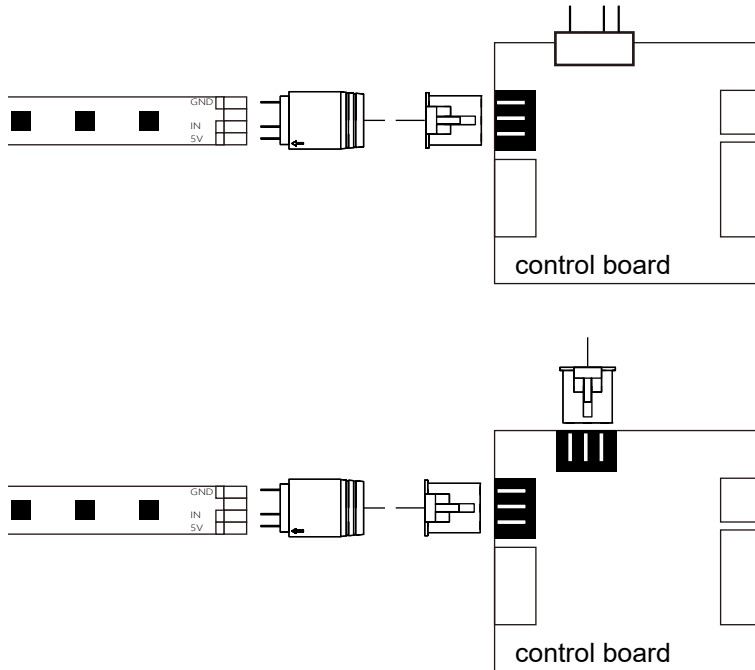

■ Connect to control box

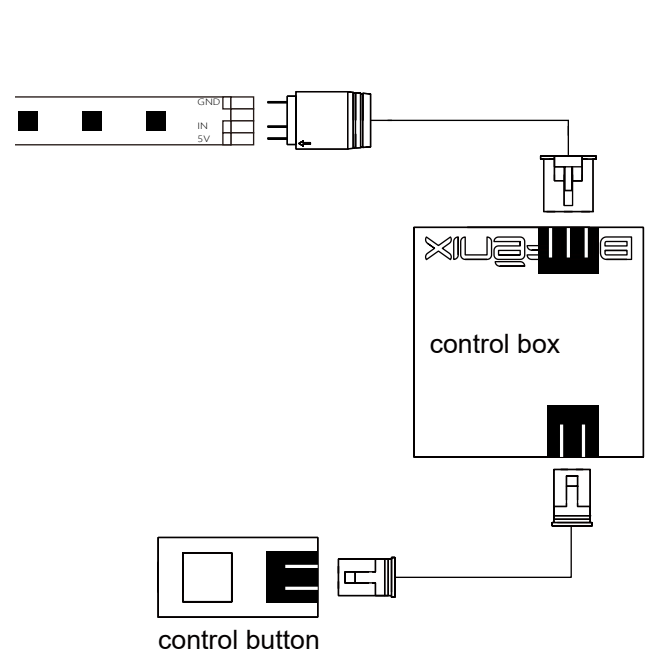

■ Daisy chain with BitFenix ARGB accessories

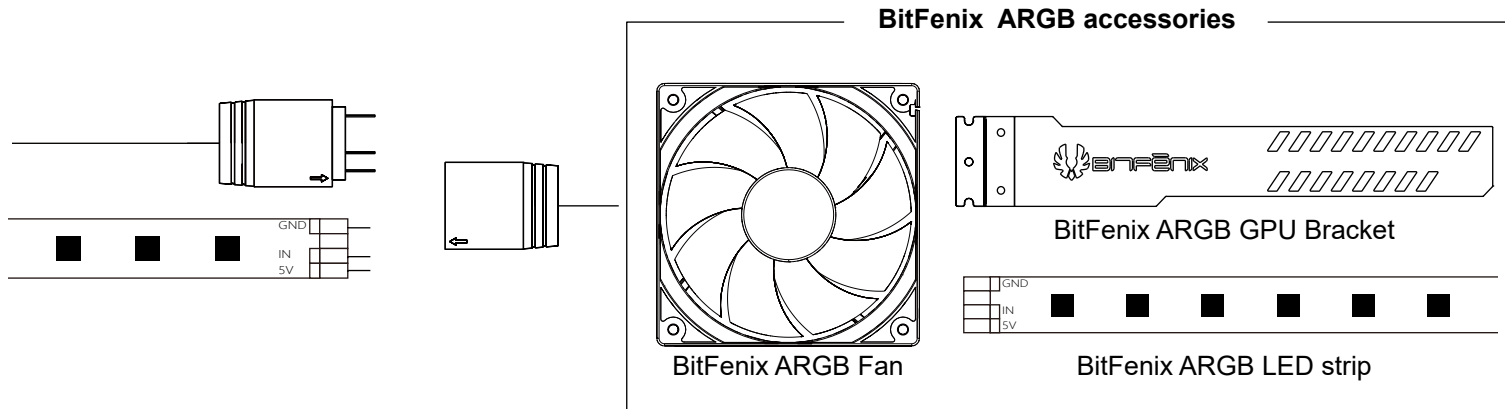

- Connect to ARGB LED connector on motherboard or control board on BitFenix cases with 3pin ARGB LED connector

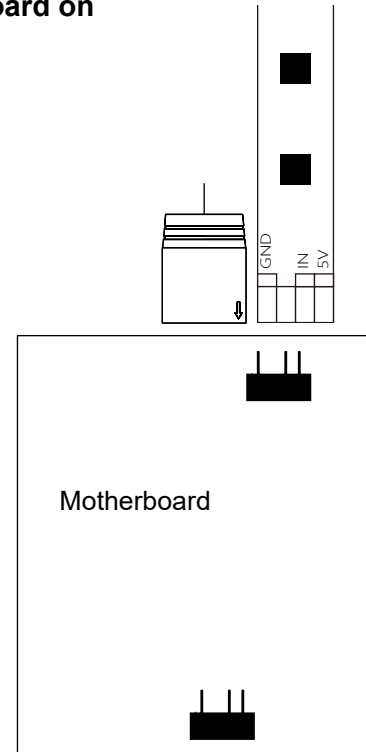
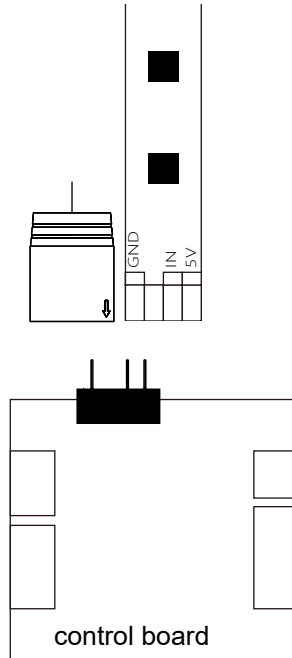

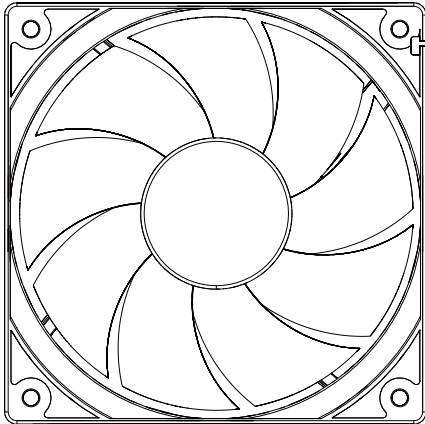

BitFenix ARGB Fan



**Connect to control
board on BitFenix
cases**

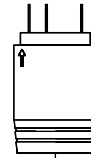

**Daisy chain with
BitFenix ARGB
accessories**

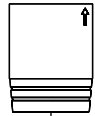

**Connect to ARGB
LED connector
on motherboard**

Connect to control board on BitFenix cases

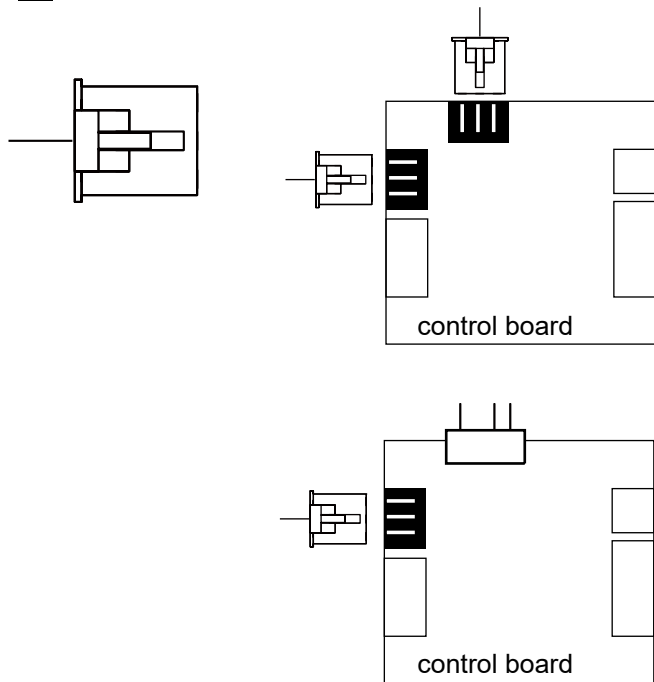

Daisy chain with BitFenix ARGB accessories

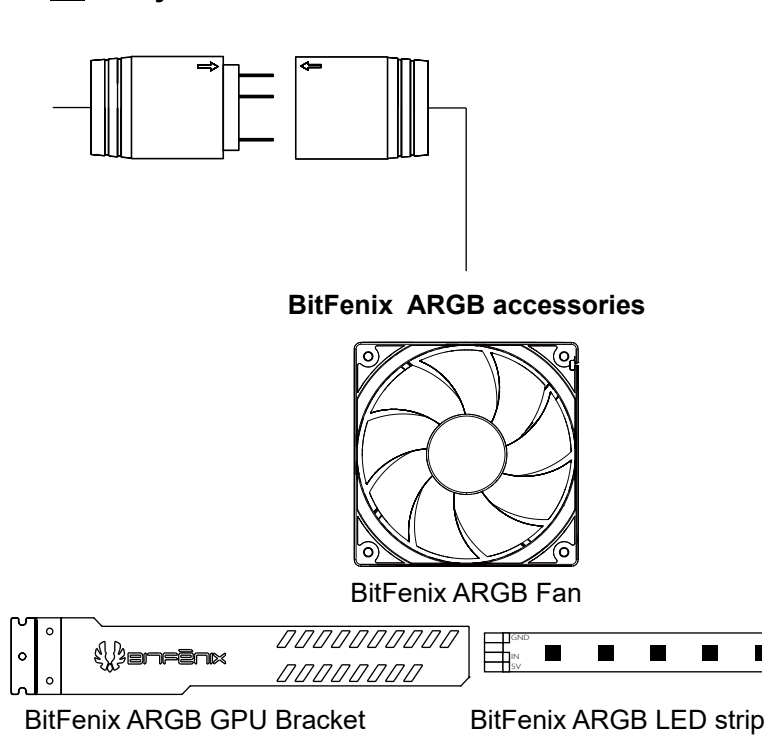

- Connect to ARGB LED connector on motherboard or control board on BitFenix cases with 3pin ARGB LED connector

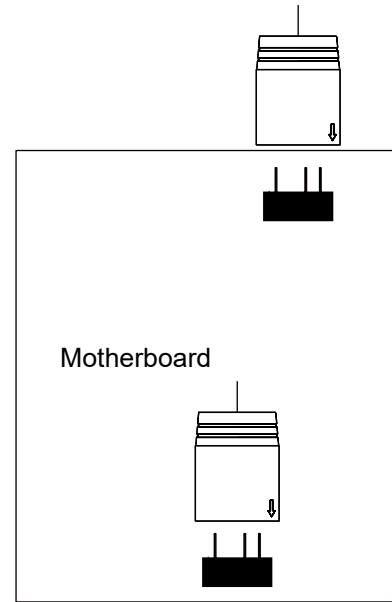
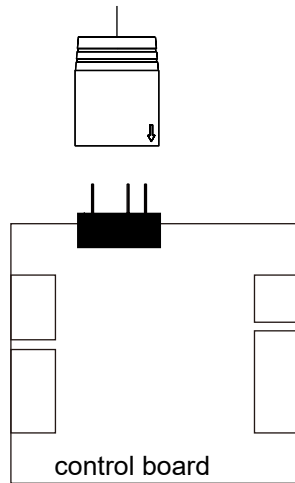
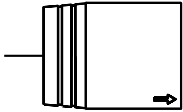

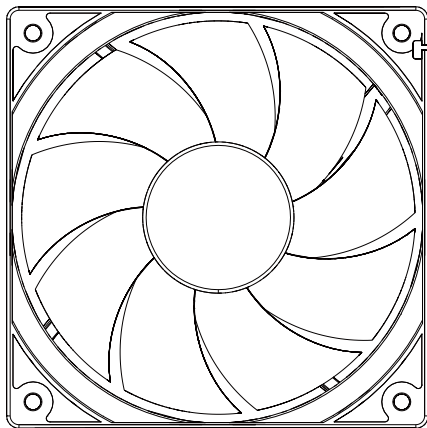

BitFenix ARGB Fan

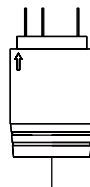

Daisy chain with BitFenix ARGB accessories



Connect to ARGB LED connector on motherboard or control board on BitFenix cases with 3 pin ARGB LED connector

■ Daisy chain with BitFenix ARGB accessories

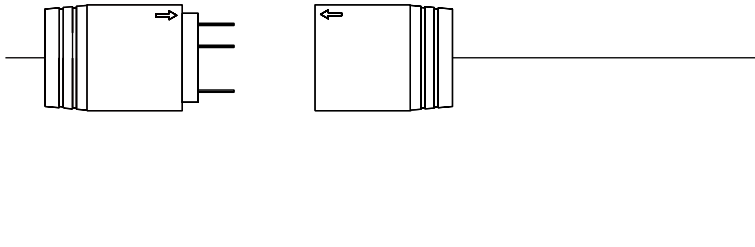

BitFenix ARGB accessories

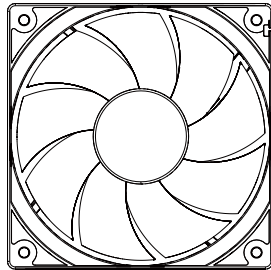

BitFenix ARGB Fan



BitFenix ARGB LED strip



BitFenix ARGB GPU Bracket

- Connect to ARGB LED connector on motherboard or control board on BitFenix cases with 3pin ARGB LED connector

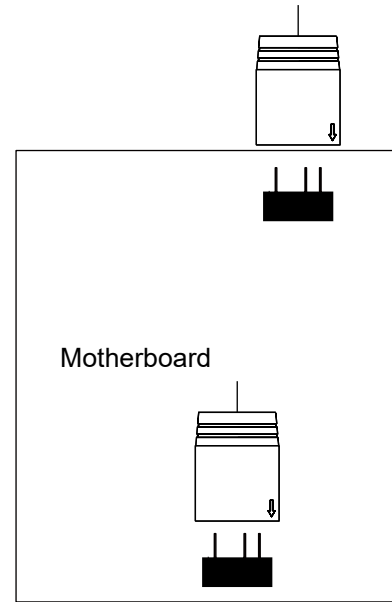
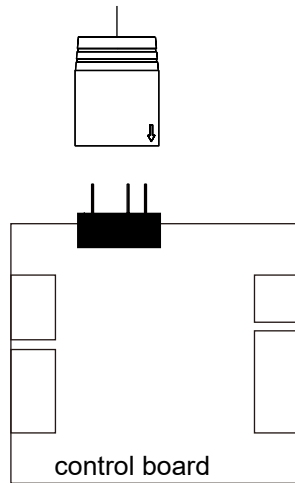
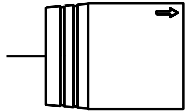

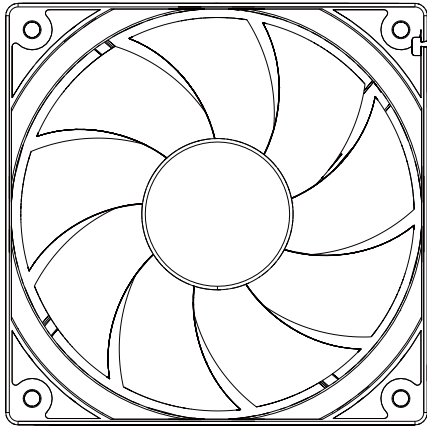

BitFenix ARGB Fan

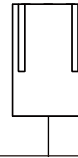

Connect to fan header on motherboard for power

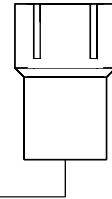

Daisy chain with other fan for power

■ Connect to fan header on Motherboard

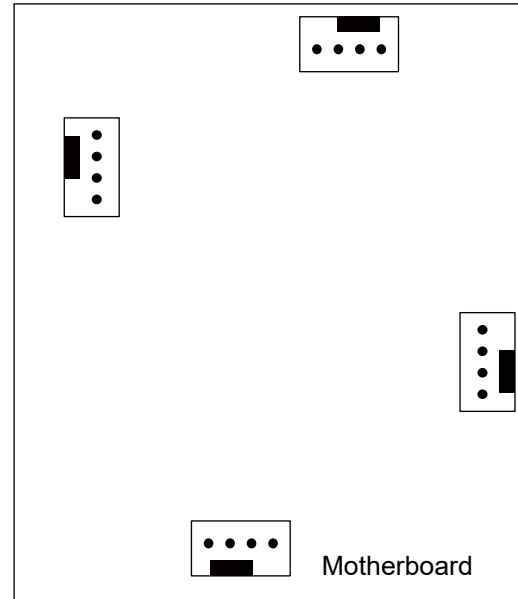
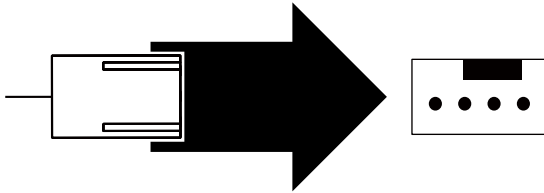

■ Daisy chain with other fan for power

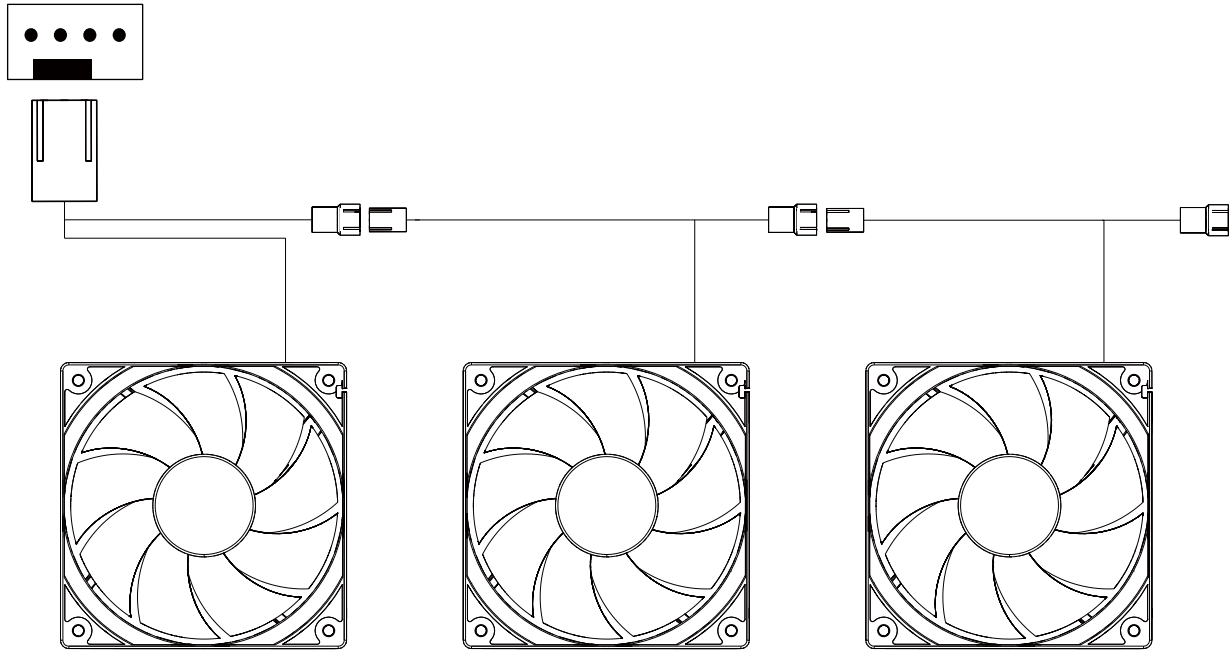

Alchemy 2.0 Magnetic RGB LED strip



Daisy chain with BitFenix RGB accessories



Daisy chain with BitFenix RGB LED strips



Connect to control board on BitFenix cases

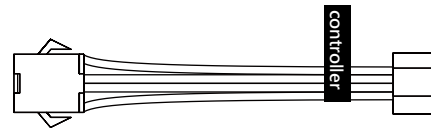

Connect to control box

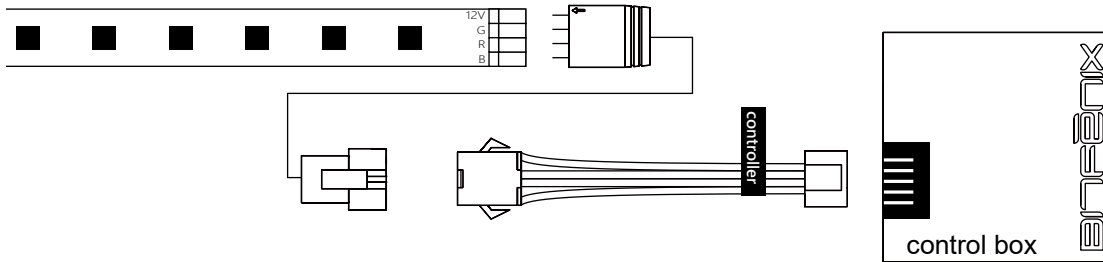

Connect to control board on BitFenix cases

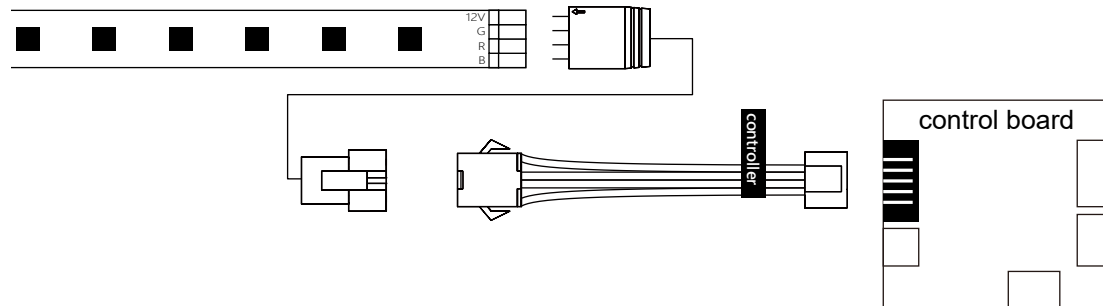

Daisy chain with BitFenix RGB LED strips

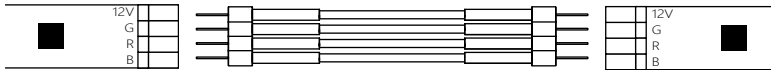

Daisy chain with BitFenix RGB LED accessories

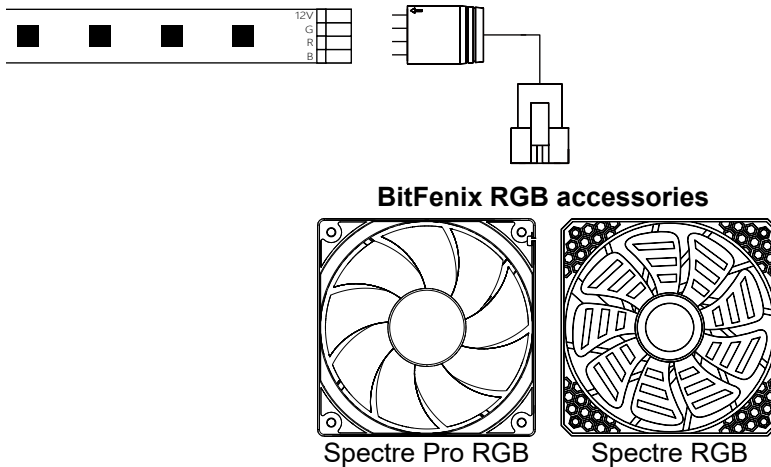

Connect to motherboard

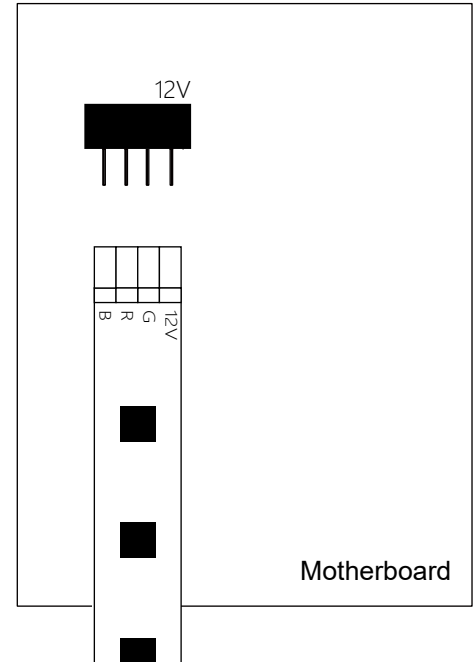

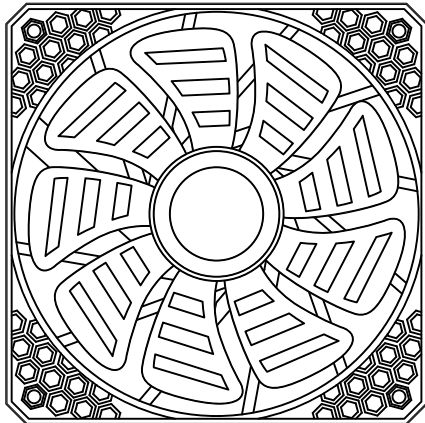

Spectre Pro RGB

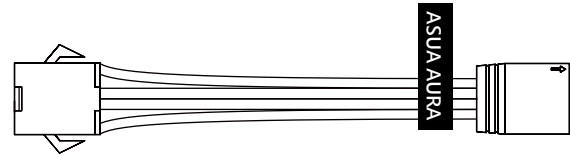

Connect to RGB LED connector on motherboard

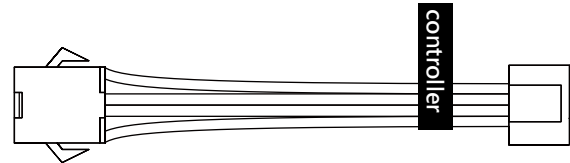

Connect to control board on BitFenix cases

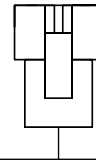

**Connect to control board
on BitFenix cases or RGB
LED connector on
motherboard**

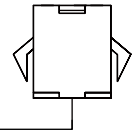

**Daisy chain with Bitfenix
RGB accessories**

■ Connect to control box

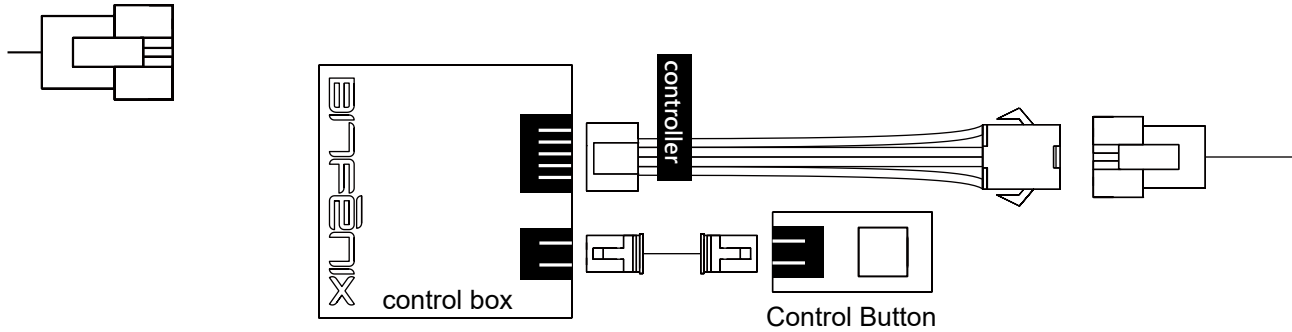

■ Connect to control board on BitFenix cases

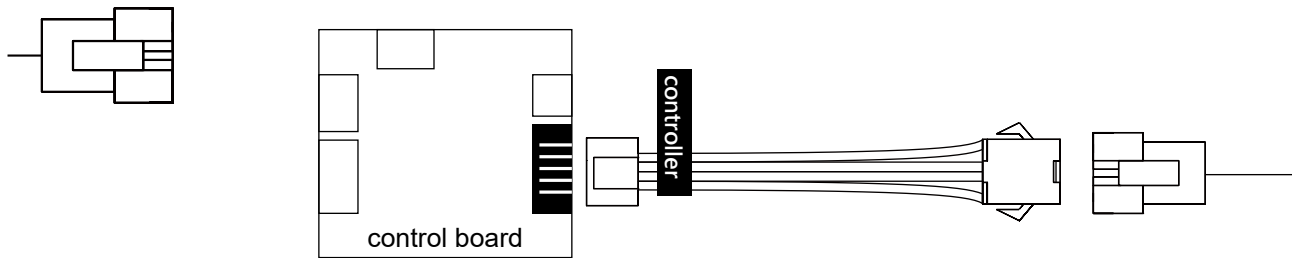

■ Daisy chain with BitFenix RGB accessories

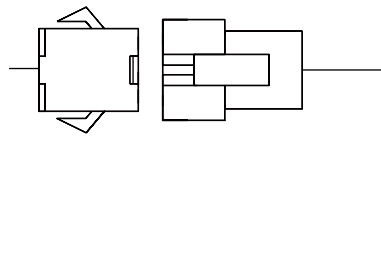

BitFenix RGB accessories

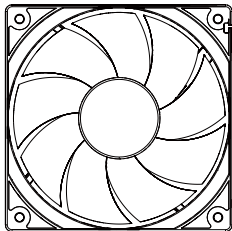

Spectre Pro RGB

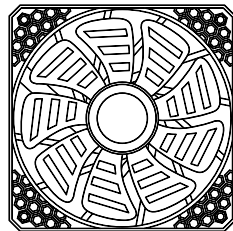

Spectre RGB



RGB LED strip

■ Connect to motherboard

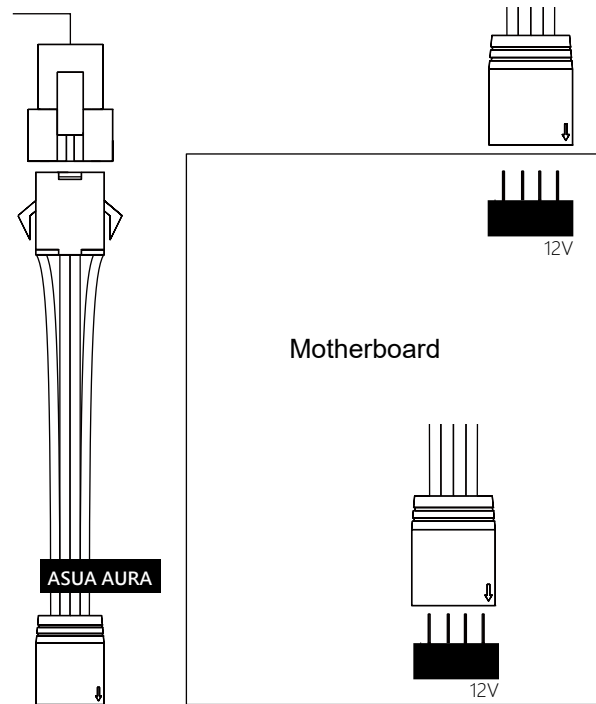

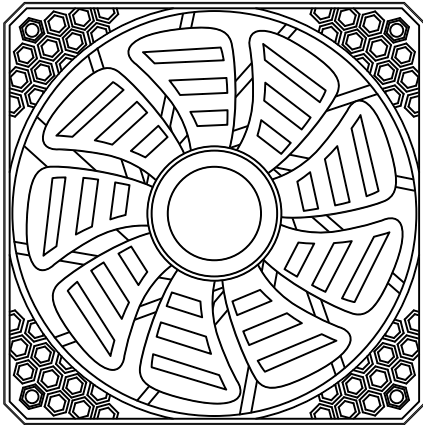

Spectre Pro RGB

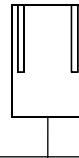

**Connect to fan header
on motherboard for
power**

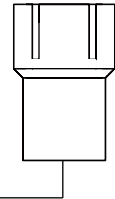

**Daisy chain with BitFenix
RGB accessories for power**

■ Connect to fan header on Motherboard

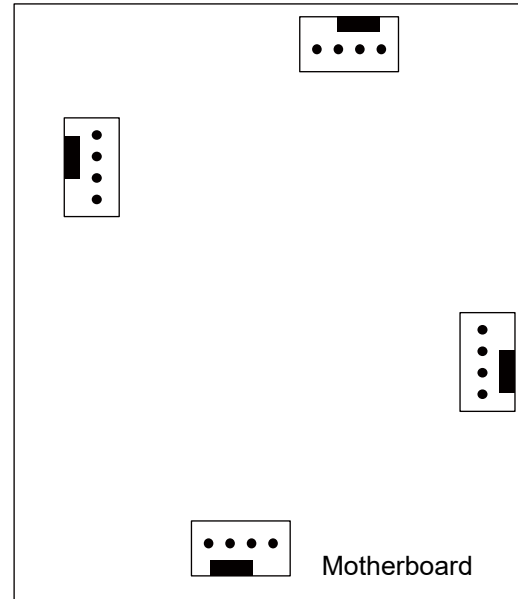
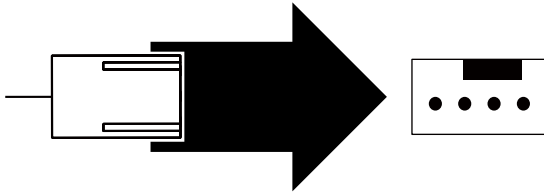

■ Daisy chain with BitFenix RGB accessories

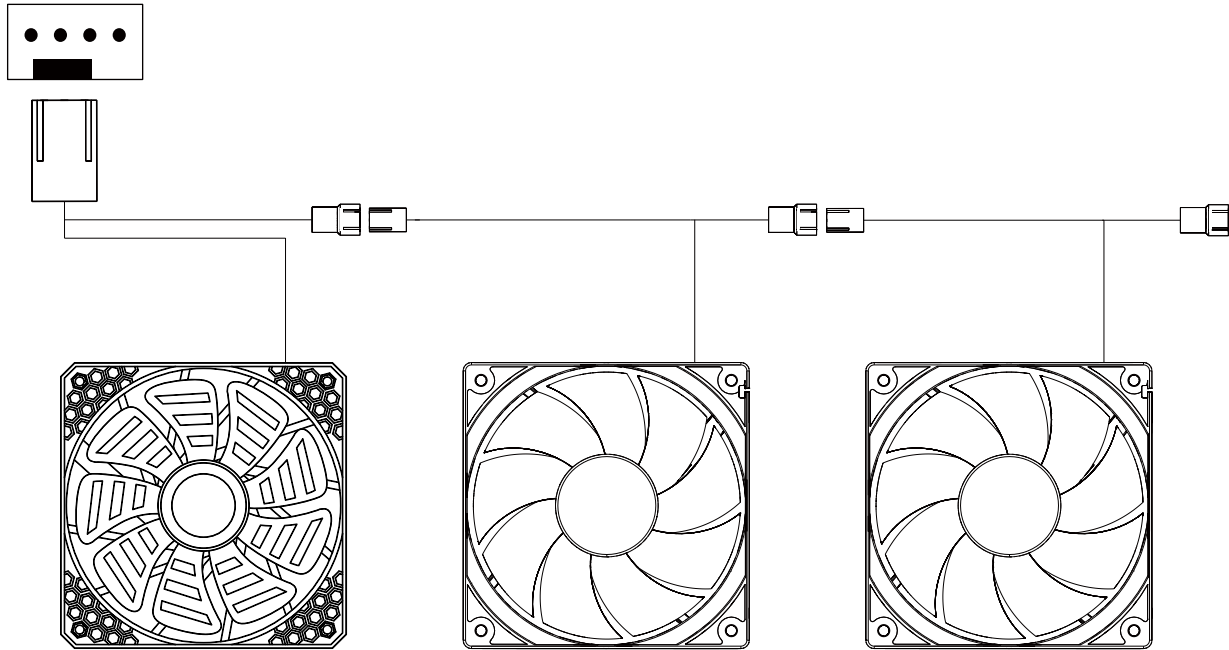

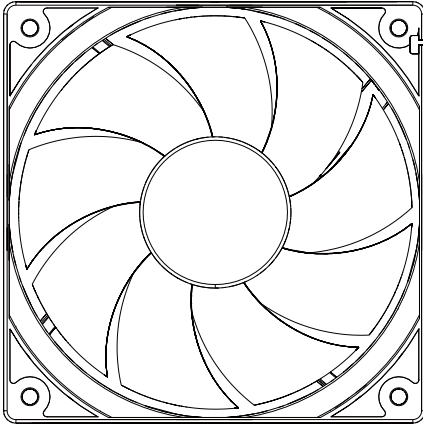

Spectre RGB

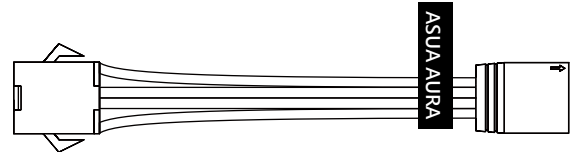

Connect to RGB LED connector on motherboard

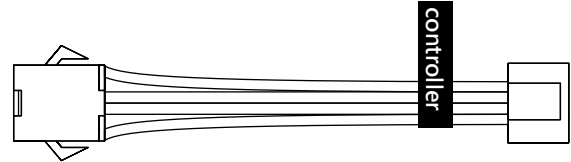

Connect to control board on BitFenix cases

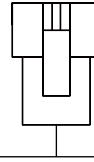

Connect to control board on BitFenix cases or RGB LED connector on motherboard

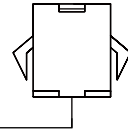

Daisy chain with BitFenix RGB accessories

■ Connect to control box

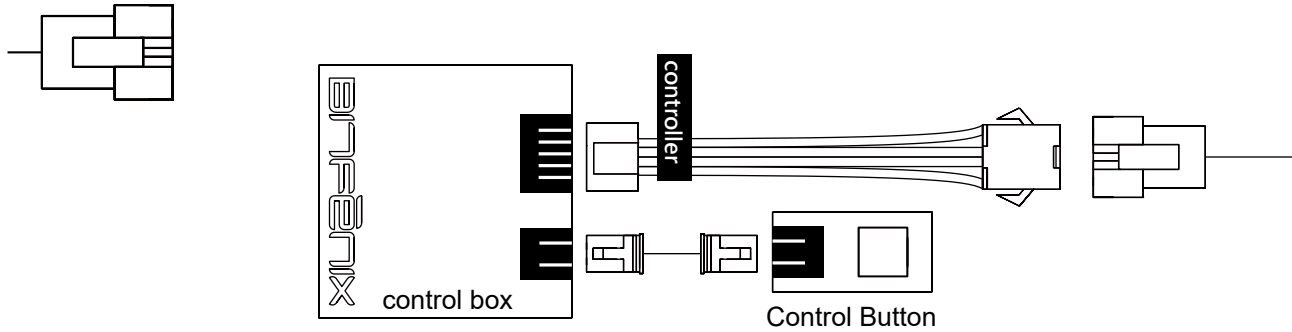

■ Connect to control board on BitFenix cases

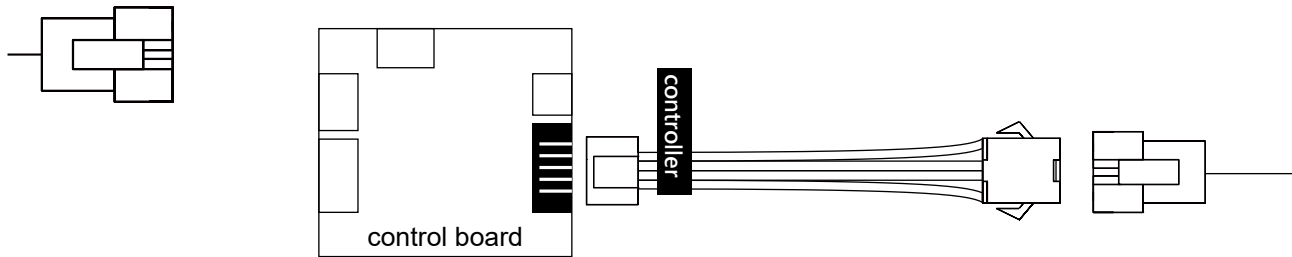

Daisy chain with BitFenix RGB accessories

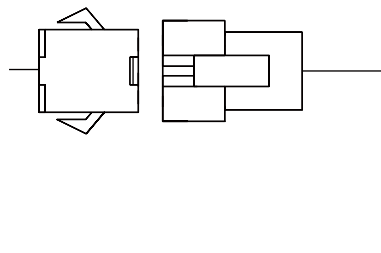

BitFenix RGB accessories

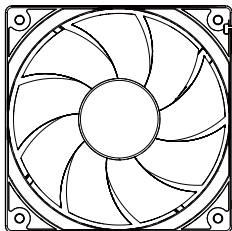

Spectre Pro RGB

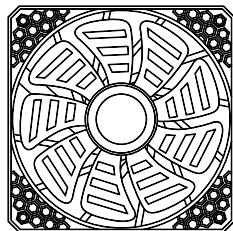

Spectre RGB



RGB LED strip

Connect to motherboard

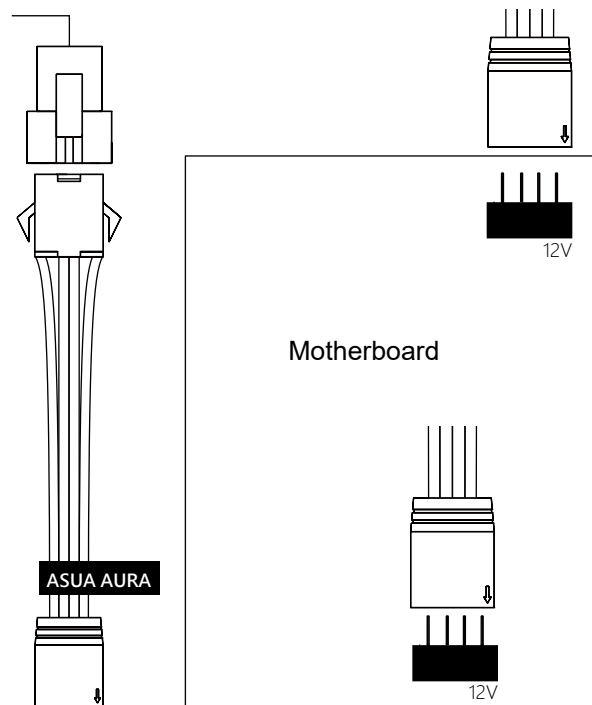

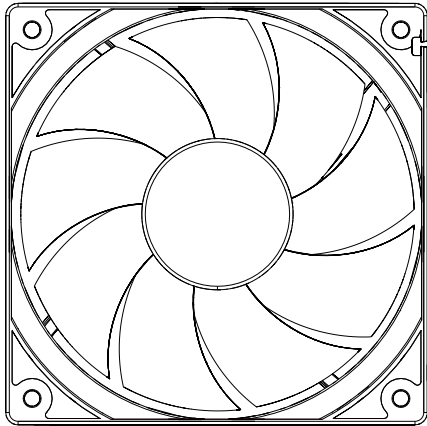

Spectre Pro RGB

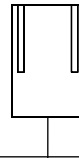

**Connect to fan header
on motherboard for
power**

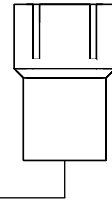

**Daisy chain with BitFenix
RGB accessories for power**

■ Connect to fan header on Motherboard

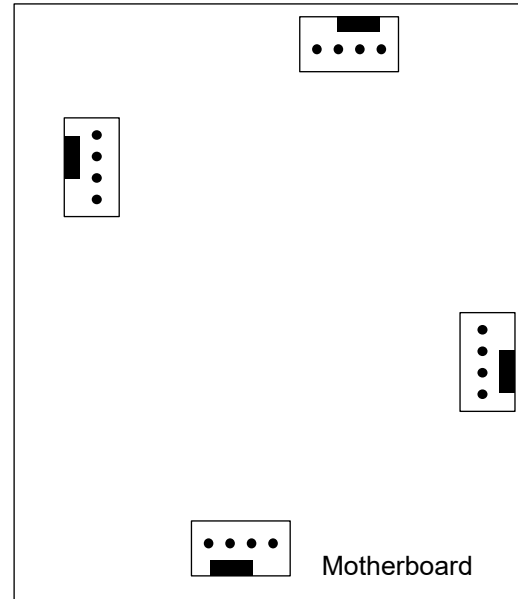
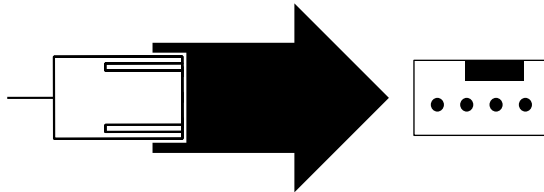

■ Daisy chain with BitFenix RGB accessories

