

## User Manual

---

LSX II

---

# Table of Contents

<b>1. Introduction</b>	<b>5</b>
<b>2. General Information</b>	<b>6</b>
2.1 Reading and Storing the User Manual	6
2.2 Signal Symbol/Word Definitions	6
<b>3. In the Box and Unpacking</b>	<b>7</b>
<b>4. Setting Up LSX II</b>	<b>8</b>
4.1 Selecting an Appropriate Router	8
4.2 Connecting to Power	9
4.3 Onboarding	10
4.3.1 Installing the KEF Connect App	10
4.3.2 Using iOS Devices	11
4.3.3 Using Android Devices with Google Play Service	12
4.3.4 Using Android Devices without Google Play Service	14
4.4 Speaker Placement and Connection	16
4.5 Installation Accessories	17
4.5.1 Wall Brackets	17
4.5.2 Desk Pads	17
4.5.3 Floor Stands	17
<b>5. Connection and Control Interface</b>	<b>18</b>
5.1 Front Panel	18
5.2 Back Panel	19
5.3 Bottom Panel	20
5.4 LED Indications	21
5.5 Remote Control	22
5.6 KEF Connect App	23
<b>6. Wi-Fi Streaming</b>	<b>24</b>
6.1 Wireless Streaming Protocols	24
6.1.1 AirPlay 2	24
6.1.2 Chromecast	25
6.1.3 ROON Ready	26
6.1.4 Music Streaming Apps Native Protocols	27
6.1.4.1 Spotify Connect	27
6.1.4.2 QPlay	28
6.1.4.3 TIDAL Connect	29
6.1.5 KEF Connect App Streaming	30
6.1.5.1 Amazon Music	30
6.1.5.2 Deezer	30
6.1.5.3 Qobuz	30
6.1.5.4 Spotify	30
6.1.5.5 TIDAL	31
6.1.5.6 Internet Radio	31
6.1.5.7 Podcasts	31
6.1.6 UPnP Playback	31
6.2 Tips on Choosing Streaming Protocols	32
<b>7. Multi-Room Streaming</b>	<b>33</b>
7.1 AirPlay 2	33

7.2 Chromecast.....	33
7.3 ROON.....	35
<b>8. Voice Control Over Mobile Device .....</b>	<b>36</b>
8.1 Siri.....	36
8.2 Google Assistant.....	36
<b>9. Playback with Bluetooth .....</b>	<b>37</b>
9.1 Selecting Bluetooth Mode.....	37
9.2 Bluetooth Pairing.....	37
9.3 Playback Controls.....	38
<b>10. Playback with HDMI ARC input .....</b>	<b>39</b>
10.1 HDMI Cable Connection.....	39
10.2 Selecting TV Mode.....	40
10.3 Playback Controls.....	40
<b>11. Playback with Optical Input .....</b>	<b>41</b>
11.1 Optical Cable Connection .....	41
11.2 Selecting Optical Mode.....	42
11.3 Playback Controls.....	42
<b>12. Playback with USB Input.....</b>	<b>43</b>
12.1 USB Connection.....	43
12.2 Selecting USB Mode.....	44
12.3 Playback Controls.....	44
<b>13. Playback with Auxiliary Input .....</b>	<b>45</b>
13.1 Auxiliary Cable Connection.....	45
13.2 Selecting Auxiliary Mode.....	46
13.3 Playback Controls.....	46
<b>14. Using KEF Connect App .....</b>	<b>47</b>
14.1 Home.....	47
14.1.1 Overview.....	47
14.1.2 Editing the Home Screen.....	48
14.2 Remote Control.....	48
14.3 Music Content.....	49
14.3.1 Playing Music from Music Streaming Services.....	50
14.3.1.1 Amazon Music.....	50
14.3.1.2 Deezer.....	51
14.3.1.3 Qobuz.....	52
14.3.1.4 Spotify.....	52
14.3.1.5 Tidal.....	53
14.3.1.6 Internet Radio.....	54
14.3.1.7 Podcast.....	54
14.3.2 Playback Controls.....	55
14.3.2.1 Playback Screen .....	55
14.3.2.2 Search.....	55
14.3.2.3 Favourites.....	56
14.3.2.4 Playing Queue.....	57
14.3.2.5 Playlists.....	59
14.4 Equalisations.....	61
14.4.1 Normal Mode .....	61
14.4.2 Expert Mode.....	63

14.4.3	Selecting a Sound Profile .....	66
14.4.4	Renaming a Sound Profile .....	66
14.4.5	Deleting a Sound Profile .....	67
14.5	Profile.....	68
14.6	Choosing Your Speaker .....	69
14.6.1	My Speaker and Speakers Nearby.....	69
14.6.2	Speaker Info .....	70
14.7	Speaker Preferences.....	71
14.7.1	Power Saver – Standby Mode .....	71
14.7.2	Power Saver – Second Wake-Up Source.....	71
14.7.3	Do Not Disturb – Standby LED .....	71
14.7.4	Do Not Disturb – Start Up tone .....	72
14.7.5	Speaker System Options – Cable Mode.....	72
14.7.6	Speaker System Options – Inverse L/R Speakers.....	72
14.7.7	KW-I Power Mode.....	72
14.8	Volume.....	73
14.8.1	Volume Display Setting.....	73
14.8.2	Hardware Volume.....	74
14.8.3	Speaker Volume Sensitivity.....	74
14.8.4	Maximum Volume.....	74
14.9	Performance.....	75
14.9.1	Streaming Settings – Audio Quality.....	75
14.9.2	Network quality.....	75
14.10	Firmware Upgrade.....	77
14.10.1	Automatic Firmware Update after Onboarding.....	77
14.10.2	Automatic Firmware Check.....	77
14.10.3	Manual Firmware Update.....	78
14.11	Application.....	79
14.11.1	Theme Settings – Theme.....	79
14.11.2	Theme Settings – Reset Home Screen .....	79
14.11.3	Analytics – Improve App/Speaker.....	79
14.12	Support.....	80
<b>15.</b>	<b>Cleaning and Maintenance .....</b>	<b>81</b>
<b>16.</b>	<b>Disposal .....</b>	<b>82</b>
16.1	Disposing of the Packaging.....	82
16.2	Disposing of the Speakers.....	82
16.3	Disposing of the Battery.....	82
<b>17.</b>	<b>FAQ and Troubleshooting .....</b>	<b>83</b>
17.1	Set-up .....	83
17.2	Playback and Streaming.....	85
17.3	Troubleshooting .....	87
17.4	LED Indicators.....	90
<b>18.</b>	<b>Appendix.....</b>	<b>94</b>
18.1	Specifications.....	94
18.2	Speaker Connection Test.....	96
18.3	Explanation of symbols.....	101
18.3.1	Warning Symbols.....	101
18.3.2	Regional Symbols.....	101
18.4	IR Command Codes.....	103



# 1. Introduction

Thank you for choosing KEF wireless speaker system – LSX II.

Innovation is what sets KEF apart from its competitors. For the last 60 years KEF has been at the forefront of loudspeaker research and development, designing class-leading speakers that have dealt with the challenges of reproducing the latest musical formats, and reproducing them to the highest possible quality. This legacy continues today with the LSX II, our compact, yet powerful speaker system for the digital music era.

The award-winning LSX just got an upgrade. Building on the acoustic excellence of the original, LSX II adds the W2 streaming platform from LS50 Wireless II and adds both HDMI ARC and USB-C to its already impressive connectivity suite. Room filling, natural sound, great looks and 'place anywhere' size – LSX II just makes HiFi easy.

Please read and follow this user manual carefully before using the speaker system.

## 2. General Information

### 2.1 Reading and Storing the User Manual



This user manual accompanies the LSX II speaker system (hereafter referred to as the “speakers”), and contains important information on setup and handling.

Before using your speakers, read this user manual and the safety information (as a separate booklet) carefully. This particularly applies to the safety information. Failure to do so may result in personal injury or damage to the speakers.

Retain the user manual and safety information for further use. Make sure to include the user manual and safety information when passing the speakers on to third parties.

### 2.2 Signal Symbol/Word Definitions

The following symbols and signal words are used in this user manual.



This signal symbol/word designates a hazard with moderate risk, which may result in death or severe injury if not avoided.



This signal word warns of possible damage to property.



This symbol provides you with useful additional information on handling and use.

---

### 3. In the Box and Unpacking

Be very careful when opening the packaging. Follow the instructions on the packaging to lift up the speakers from the sides to avoid damaging the Uni-Q drivers.

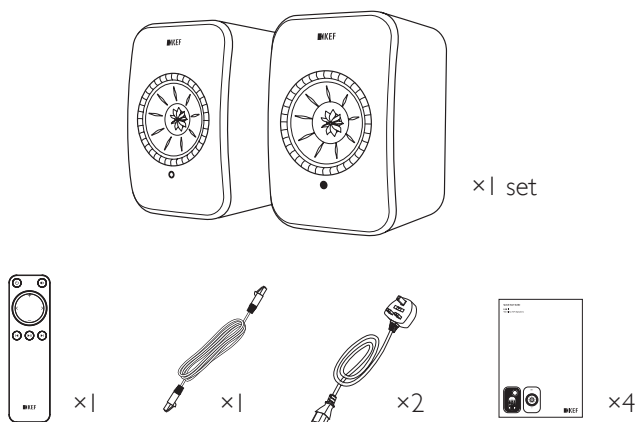

1. Take the speakers and accessories out of the packaging.
2. Check to make sure that all parts are included, namely:
  - Speaker ×2 (Primary Speaker ×1, Secondary Speaker ×1)
  - Remote control ×1 (with 2 AAA batteries)
  - Inter-speaker cable ×1 (length: 3 m)
  - Power cable ×2 (length: 2 m, with country-specific power plugs)
  - Printed materials: Quick Start Guide, Safety Information, Warranty Information and Fabric Cleaning Guide
3. Check whether the speakers or individual parts are damaged. If this is the case, do not use the speakers and contact your retailer.

## 4. Setting Up LSX II

### 4.1 Selecting an Appropriate Router

The speakers must be “onboarded” to your Wi-Fi network (see chapter “[Onboarding](#)”) for the best sound quality, wireless streaming and comprehensive control.

#### Technical Requirements of your Router

- Network standard: IEEE 802.11 a/b/g/n/ac, IPv4, IPv6,
- Frequency band: Dual-band 2.4 GHz / 5 GHz



- A 5 GHz Wi-Fi network is recommended for stable streaming, especially for hi-resolution music.
- **Connecting to a guest, office or public network:** Office, hotel, guest and public networks often feature additional security or authentication methods which may prevent the speakers from connecting. You may need the help of the network administrator to configure the network to allow full functionality if using these kinds of networks.

## 4.2 Connecting to Power

1. Connect the power cables into the AC input connectors (A) on the back panels of the Primary and Secondary Speakers.

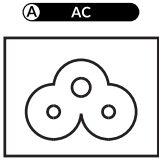

2. Connect the power plugs into the power sockets/outlets.

After successful power connections, the LED indicator light of the Primary Speaker will blink white and amber. The speakers are now ready to be “onboarded” to your personal Wi-Fi network through the KEF Connect App (see chapter “[Onboarding](#)”).

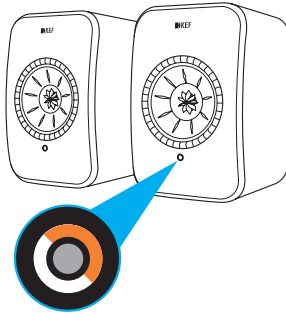

## 4.3 Onboarding

### 4.3.1 Installing the KEF Connect App

Install the KEF Connect App on your mobile device to get the speakers “onboarded” to your Wi-Fi network.

1. Search “KEF Connect” in the App Store or Google Play Store to download and install the KEF Connect App on your iOS\* or Android\*\* device.



2. Launch the KEF Connect App on your device and create a user account. You may log in with your existing Facebook, Google or Apple account, or create a new KEF account with your email address.

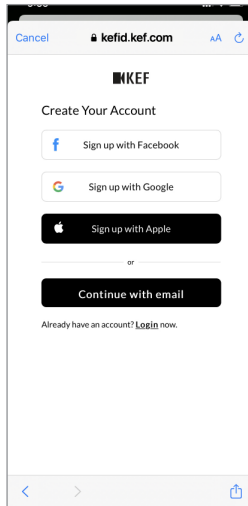
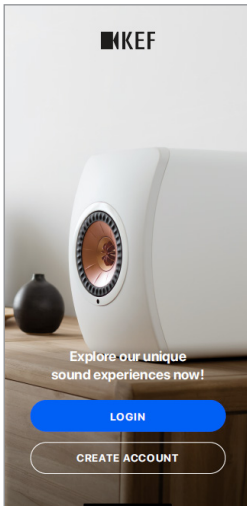



\*Requires iOS 14 or above. Refer to App Store for the latest requirements.

\*\*Requires Android 8 or above. Refer to Google Play for the latest requirements.

## 4.3.2 Using iOS Devices

1. Make sure your mobile device is connected to the network you want to onboard your speaker to.
2. Launch and login to the KEF Connect App on your mobile device.
3. Select "LSX II" under "Speakers nearby".

The speakers with the warning sign (  ) are not set up yet. Select the speakers with this warning mark to get them "onboarded".

The speakers with the check mark (  ) are ready for use. This icon will show for speakers already onboarded or directly connected to the network via a cable.

4. Select your local Wi-Fi network. Press "Next" to begin the onboarding process.

You may rename the speakers by tapping "Speaker name".

5. The onboarding process will be done automatically. Tap "Done" when the process is completed.

[Step 3–5]

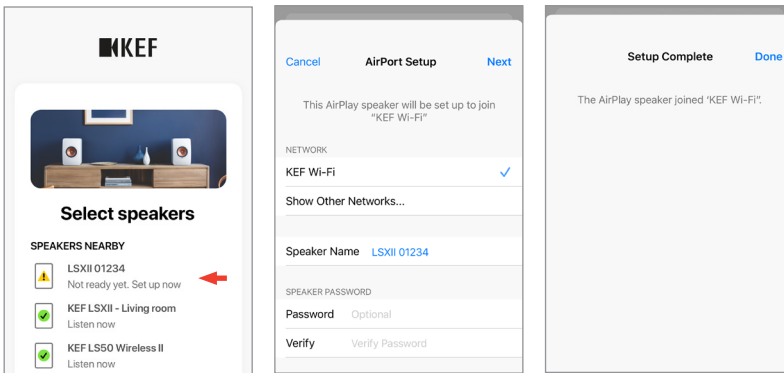

- The LED indicator light of the Primary Speaker illuminates white briefly and then fades out when the speakers are successfully connected.

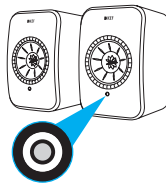

- After successful connection, you may be prompted if there is a new firmware update available. Follow the instructions in the KEF Connect App to complete the update process.

### 4.3.3 Using Android Devices with Google Play Service

1. Make sure your mobile device is connected to your local Wi-Fi network.
2. Launch and login to the KEF Connect App on your mobile device.
3. Allow the app to access your device's location when requested.
4. Select "LSX II" under "Speakers nearby".

The speakers with the warning sign (  ) are not set up yet.

The speakers with the check mark (  ) are ready for use.

5. Tap "Open Google Home" to proceed. If your mobile device does not have Google Home, you will be prompted to download and install the app on your device.

[Step 3–5]

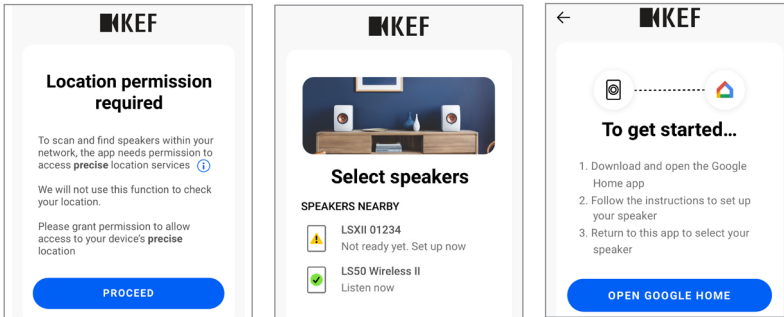

6. Tap "Set up LSX II" at the top of the screen.
7. Tap "Add another home".
8. Create a nickname for the home and then tap "Next".

[Step 6–8]

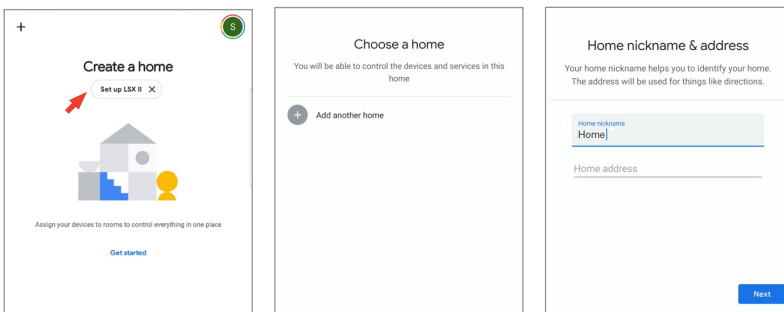

Google Home will start to look for and connect to the speakers. Follow the instructions on the screen to assign a use location (e.g home) and connect the speakers to your local Wi-Fi network.



9. When the process is completed, tap “Continue” to start using the KEF Connect App.



- The LED indicator light of the Primary Speaker illuminates white briefly and then fades out when the speakers are successfully connected.

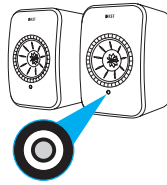

- After successful connection, you may be prompted if there is a new firmware update available. Follow the instructions in the KEF Connect App to complete the update process.
- The latest operations of the Google Home App may differ from the above.

### 4.3.4 Using Android Devices without Google Play Service

1. Make sure your mobile device is connected to your local Wi-Fi network.
2. Launch and login to the KEF Connect App on your mobile device.
3. Allow the app to access your device's location when requested.
4. Tap “Choose a Wi-Fi network”.
5. Select your local Wi-Fi network and then tap “OK”.

[Step 3–5]

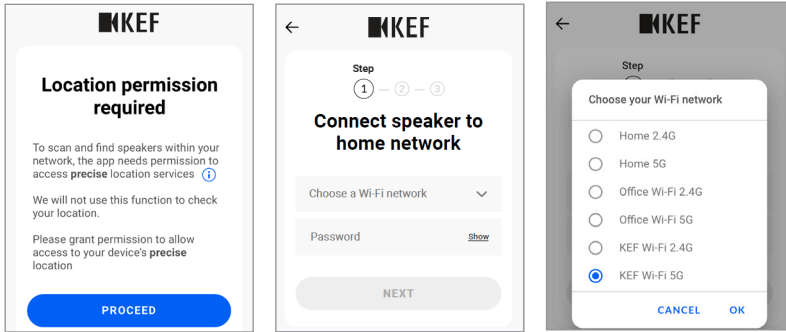

6. Input the password of your local Wi-Fi network and then tap “Next”. The connection process will be done automatically.
7. If preferred, create a new name for the speakers and then tap “Next”. This name will be used for Wi-Fi and Bluetooth connections.
8. Tap “Let’s start” to enjoy your speakers.

[Step 6–8]

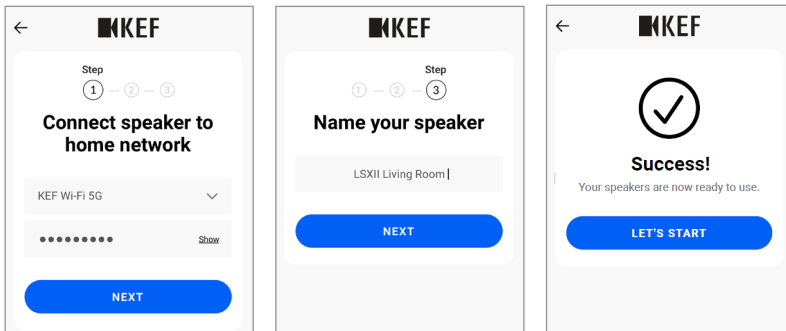



- The LED indicator light of the Primary Speaker illuminates white briefly and then fades out when the speakers are successfully connected.

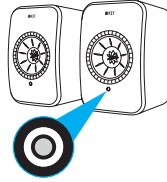

- After successful connection, you may be prompted if there is a new firmware update available. Follow the instructions in the KEF Connect App to complete the update process.

## 4.4 Speaker Placement and Connection

- The speakers should be placed on a flat and level surface that is free from vibration.
- The two speakers are distinguished between the Primary Speaker and the Secondary Speaker. By default, the Primary Speaker is the right channel\* and should be placed on your right hand side as you face the speakers. For the best stereo experience, soundstage and stable connection, place the speakers within 8 meters apart.

\*The left and right channels can be swapped through the KEF Connect App. See chapter “[Speaker System Options – Inverse L/R Speaker](#)”.

- The optimum distance between the speakers and the listener will depend on how far the Primary Speaker and the Secondary Speaker are separated, or vice versa. Try to keep the same distance to the listener to form an equilateral triangle.

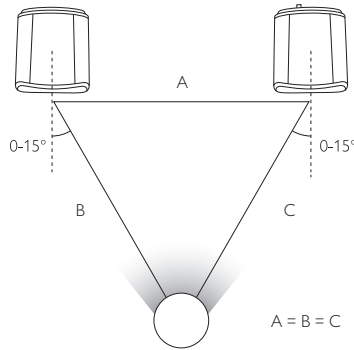

- The two speakers are already paired and will be automatically connected with each other wirelessly (resolution: 48 kHz/24 bit). If you prefer a higher resolution (96 kHz/24 bit) or are experiencing frequent audio dropouts due to interference, use the provided inter-speaker cable (length: 3 m) to link the two speakers (see chapter “[Back Panel](#)”).
- If a longer inter-speaker cable is required, the [K-Stream cable](#) is recommended.



### Maximum Distance between the Two Speakers

Wireless Mode	Up to 8 meters. Note that RF interference, including Wi-Fi, Bluetooth, microwaves and IoT devices, may reduce this distance.
Wired Mode	Use the provided inter-speaker cable or connect with a shielded Cat-6 Ethernet cable. The cable length should be within 10 meters.

## 4.5 Installation Accessories

These accessories (sold separately) provide more installation options to suit your listening environments. Please visit the [KEF website](#) for product details.

### 4.5.1 Wall Brackets

They offer a quick and elegant method of attaching the speakers to a wall and are capable of rotating the speakers 90° to either side or down.

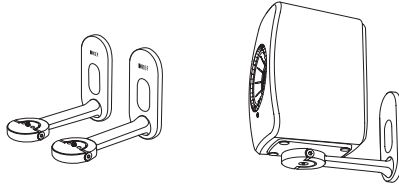

### 4.5.2 Desk Pads

They are ideal when using the speakers as a pair of desktop loudspeakers, either side of a television, on a bookshelf or in a cabinet.

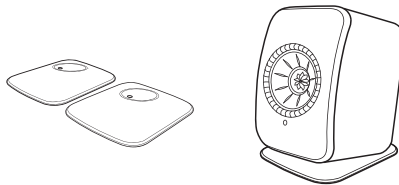

### 4.5.3 Floor Stands

They offer a perfect platform for the speakers to perform, featuring a cable management system.

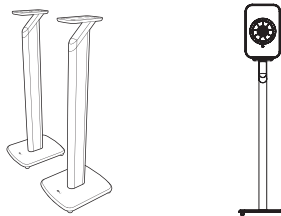

## **⚠ WARNING!**

Be aware of the potential hazards from tipping or knocking the speakers off the stands which may result in personal injury, or property damage.

## 5. Connection and Control Interface

### 5.1 Front Panel

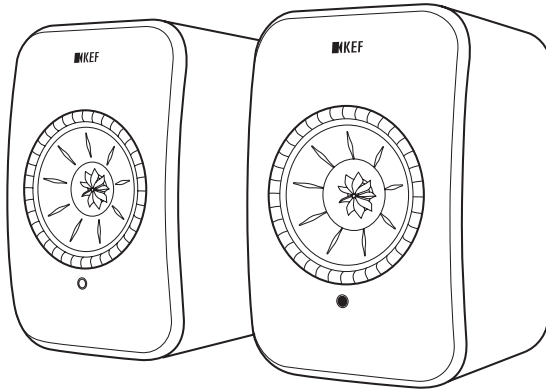

Secondary Speaker

Primary Speaker

- An LED indicator light can be found on each speaker, below the Uni-Q driver (speaker cone).
- The IR (infrared) receiver for the remote control can be found on the Primary Speaker where the LED indicator light is located.



The LED indicator light of the Secondary Speaker only comes on when:

- The Secondary Speaker is initially connected to power and is working properly. The LED indicator light will briefly come on orange and then go out.
- An error occurs.
- During normal operation the LED indicator light on the Secondary Speaker will not illuminate.

## 5.2 Back Panel

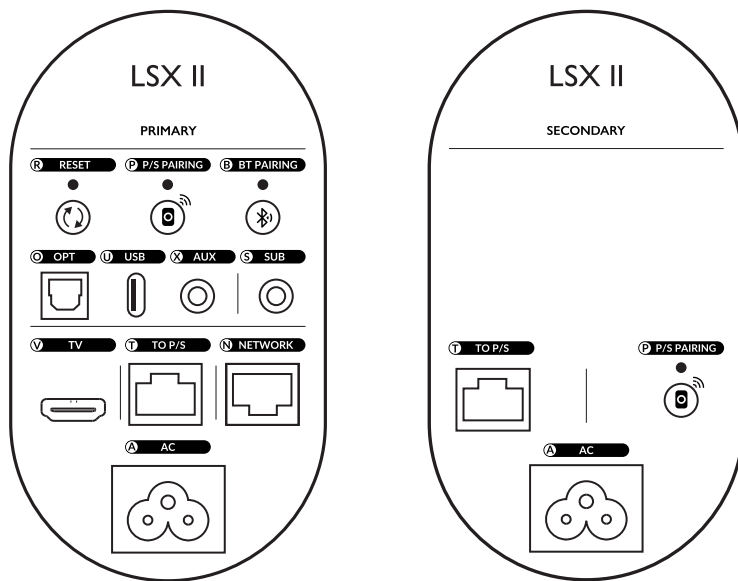

Controls and connections are found on the back panel of each speaker, marked as shown.

<b>R</b> Factory reset button	Resets the speakers to the factory defaults (including network settings and all EQ and system preferences). Press and hold the button until the indicator light above the button blinks.
<b>P</b> P/S pairing button	Re-establishes the connection between the Primary Speaker and the Secondary Speaker if the connection is lost.
<b>B</b> Bluetooth pairing button	Enables Bluetooth pairing. The speakers will be ready to pair with a new device. Any Bluetooth connected device will be disconnected.
<b>O</b> Optical input jack	Plays audio input from a source (e.g. Blu-ray player, cable box) through an optical cable.
<b>U</b> USB port (type C)	Plays audio input from a computer or charges an external device* (e.g. <a href="#">KW-I Wireless Kit</a> ). *Requires activation of the <a href="#">USB charging function</a> in the KEF Connect App. The USB audio input function will be disabled.

<b>X</b>	Auxiliary input jack	Plays audio input from a source (e.g. turntable with phono stage) through a 3.5 mm audio cable.
<b>S</b>	Subwoofer output jack	Connects a subwoofer to the speakers through an RCA cable.
<b>V</b>	TV port	Plays audio input from a source (e.g. ARC port of television) through an HDMI cable.
<b>T</b>	Primary/Secondary connection port	Connects the Primary Speaker and Secondary Speaker with the inter-speaker cable.
<b>N</b>	Network port	Connects the speakers to a router with a LAN cable. This port is colour-coded yellow.
<b>A</b>	AC input connector	Connects the speakers to the power source with the power cables.

### 5.3 Bottom Panel

- Rubber feet are found on the bottom panel of each speaker to prevent slipping on a hard surface.
- Additionally, a threaded hole (1/4–20 UNC) is also available for mounting on various accessories (see chapter “[Installation Accessories](#)”).

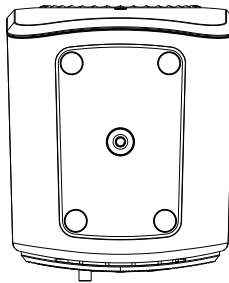







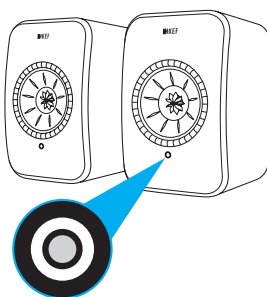



## 5.4 LED Indications

The connection and operation status can be easily checked through the colours and patterns of the LED indicator on the Primary Speaker.



Pattern	Status
 Blinking white and amber	The speakers are ready to connect to a Wi-Fi network. Launch the KEF Connect app to set up the speakers.
 Solid amber*	The speakers are in Standby Mode and connected to a Wi-Fi network.
 Solid white*	The speakers are operating in Wi-Fi Mode.
 Solid green*	The speakers are operating in Spotify Connect Mode.
 Solid blue*	The speakers are operating in Bluetooth Mode and a device is already paired with the speakers.
 Solid light blue*	The speakers are operating in TV Mode.
 Solid purple*	The speakers are operating in Optical Mode.
 Solid pink*	The speakers are operating in USB Mode.
 Solid yellow*	The speakers are operating in AUX Mode.

\*The LED indicator light illuminates briefly and fades out when there are no active interactions with the speakers (e.g. controlling playback or volume).



For a full list of colours and patterns, see chapter "[LED Indicators](#)".

## 5.5 Remote Control

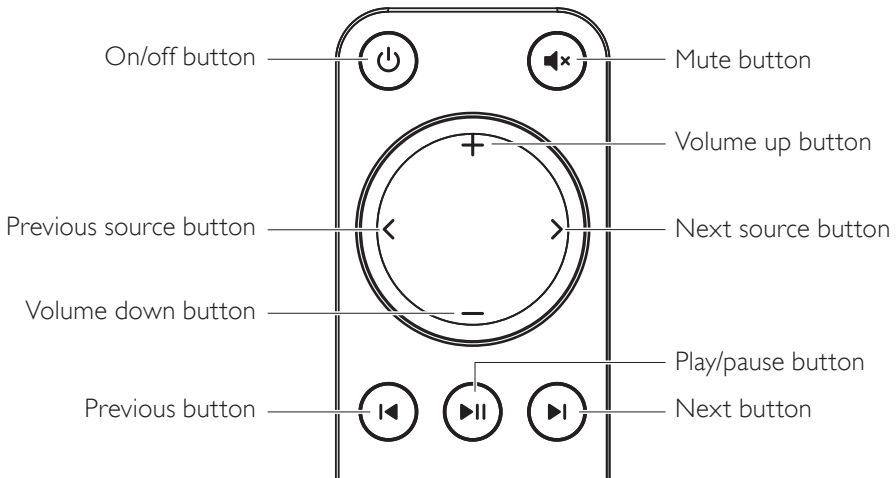

- Insert two AAA batteries into the battery compartment before use. To do so, slide open the battery compartment cover on the back and insert the batteries into the compartment according to the polarity (+/-). Close the battery compartment cover when done.
- Point the remote control to the IR receiver located on the front panel of the Primary Speaker. Make sure there are no obstacles between the remote control and the Primary Speaker during use.
- If the remote control is less responsive or not working, the battery power may be low. Replace the batteries to see if this is the case.

## 5.6 KEF Connect App

The KEF Connect App allows you to set up the speakers, apply sound settings, turn on/off the speakers, switch sound sources, and access and play back your streaming music and music stored in media server.

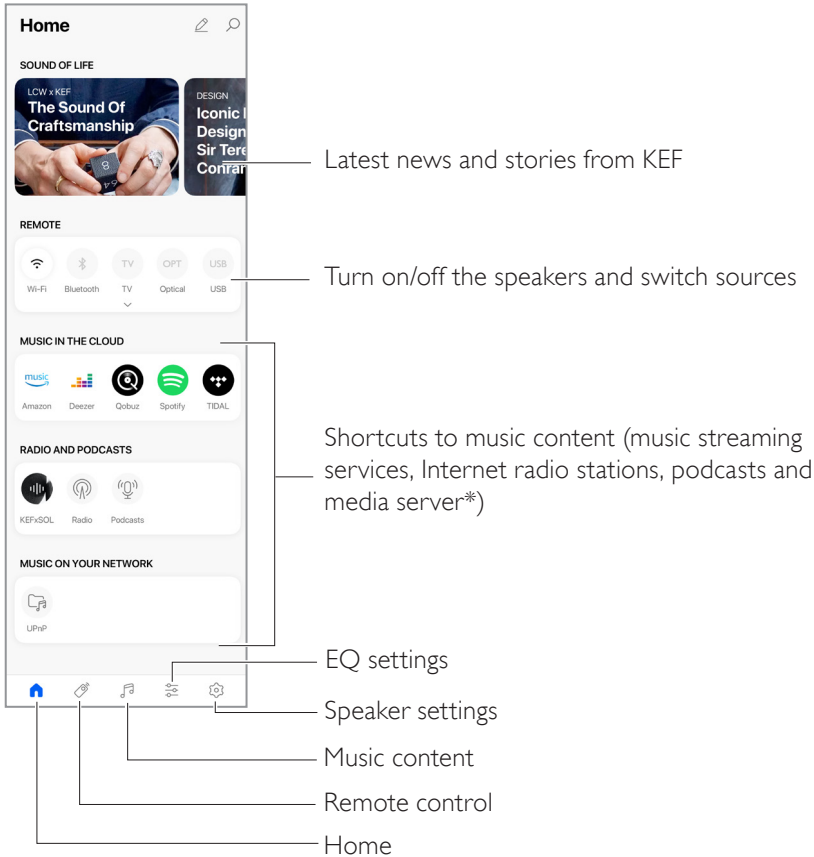

\*Coming soon



For details, see chapter "[Using KEF Connect App](#)".

## 6. Wi-Fi Streaming

### 6.1 Wireless Streaming Protocols



To stream audio to the speakers, your mobile device must be connected to the same Wi-Fi network as the speakers. The speakers can be turned on from standby mode through all wireless streaming protocols.



#### 6.1.1 AirPlay 2

AirPlay 2 lets you share audio output from Apple devices to the speakers.



1. Start music or video playback on your iOS device.
2. For music streaming, tap the AirPlay icon (  ) in the playback screen.



For audio streaming from the YouTube app, tap the connection icon (  ) in the playback screen and then tap the AirPlay icon (  ).

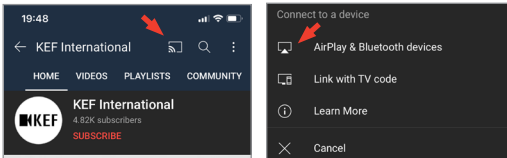

3. Select "LSX II" (or the name you have created for the speakers) from the selection menu to start streaming.



The availability for streaming depends on the app compatibility.

## 6.1.2 Chromecast

If your device is Chromecast-enabled, you can stream audio output from the device to the speakers.



1. Start music or video playback on your Chromecast-enabled device.
2. In the Google Home App, tap "LSX II" (or the name you have created for the speakers).
3. Tap "Cast my audio".

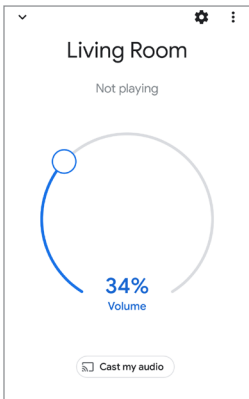

- The availability for streaming depends on the app compatibility.
- The latest operations of the Google Home App may differ from the above.

## 6.1.3 ROON Ready



Roon is a high quality music management system that pulls together music from a NAS drive, locally stored music (i.e. on your computer), compatible streaming services and Dropbox to create a searchable, surfable magazine about your music. The speakers are certified “Roon Ready”. For more information on Roon, visit [roonlabs.com](http://roonlabs.com).

1. Enable the speakers in the Audio menu.



Note: KEF LSX II will be Roon Ready soon.

2. To stream music, click the “Zone Picker” next to volume at the footer of Roon and then select “KEF LSX II” (or the name you have created for the speakers) from the device list.

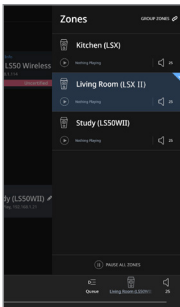

3. The signal path can be found by clicking the little coloured light in the footer.

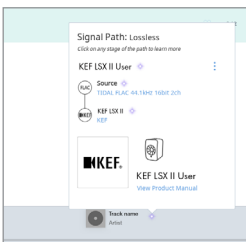

## 6.1.4 Music Streaming Apps Native Protocols

### 6.1.4.1 Spotify Connect



Spotify is a digital music and podcast streaming service that gives you access to millions of songs and other content from artists all over the world. The speakers are ready for Spotify Connect.

1. Browse and select music to play in the Spotify App.
2. Tap the device icon (  ) at the bottom of the playback screen.
3. Select “LSX II” (or the name you have created for the speakers) from the selection menu to start streaming.

[Step 1–3]

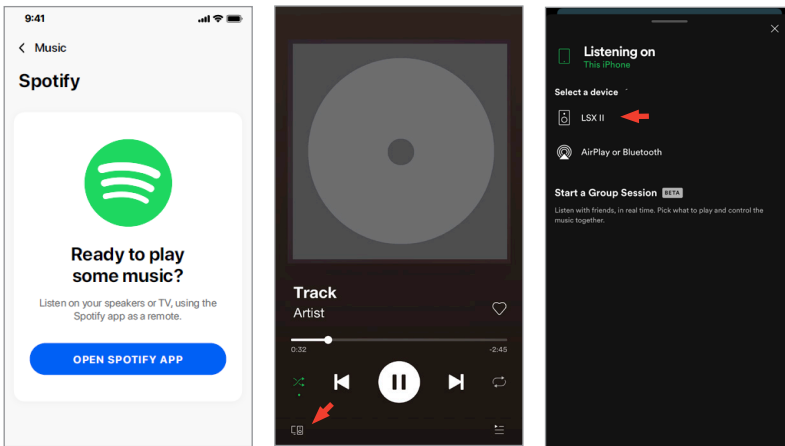

## 6.1.4.2 QPlay



QQ Music is one of China's most popular online music streaming services. QPlay lets you stream music directly from the QQ Music App. The speakers are ready for the QPlay feature.

1. To stream music, launch the QQ Music App and enable QPlay in the settings.
2. Browse and play music.
3. Tap the QPlay icon (  ) on the playback screen.

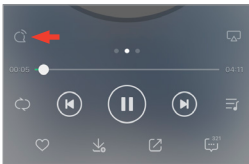

4. Select "KEF LSX II" (or the name you have created for the speakers) from the device list to start streaming.





### 6.1.4.3 TIDAL Connect

## TIDAL connect

TIDAL is a subscription-based music, podcast and video streaming service that combines lossless audio and high-definition music videos with exclusive content and special features on music. The speakers are ready for the TIDAL Connect feature for music streaming.

1. To stream music, select the content you want to play in the TIDAL Connect App and then select the connect icon () in the “Now Playing” screen.
2. Select “LSX II” (or the name you have created for the speakers) from the list of nearby devices to pair with the Tidal Connect App to start streaming.

[Step 1–2]

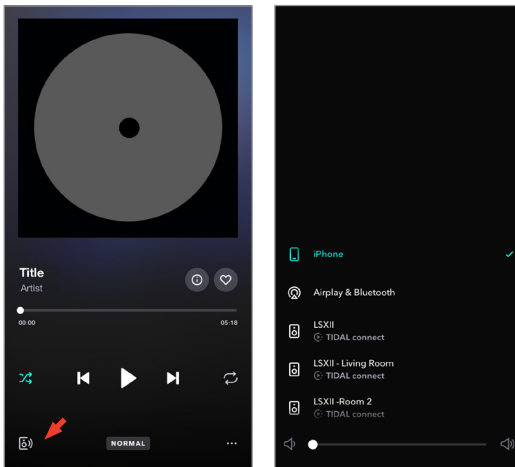

## 6.1.5 KEF Connect App Streaming



The KEF Connect App offers direct access to various music streaming services for playback through the speakers. For details, see chapter “[Playing Music from Music Streaming Services](#)”

### 6.1.5.1 Amazon Music



Amazon Music is a music streaming platform and online music store operated by Amazon. You can access your Amazon Music account through the KEF Connect App to stream music to the speakers. High-res audio is supported with Amazon Music Unlimited subscription.

### 6.1.5.2 Deezer



Deezer is an online music streaming service. It allows users to listen to music content from a wide range of record labels on various devices online or offline. You can access your Deezer account through the KEF Connect App to stream music to the speakers.

### 6.1.5.3 Qobuz



Qobuz is a music streaming and downloading service offering hi-resolution streaming to its subscribers. You can access your Qobuz account through the KEF Connect App to stream music to the speakers.

### 6.1.5.4 Spotify



Through the KEF Connect App, you will be prompted to open the Spotify app on your device in order to stream music to the speakers. See chapter “[Spotify Connect](#)”.

### 6.1.5.5 TIDAL



TIDAL is a subscription-based music, podcast and video streaming service that combines lossless audio and high-definition music videos with exclusive content and special features on music. You can access your TIDAL account through the KEF Connect App to play hi-resolution audio. A valid Hi-Fi tier subscription is required.

### 6.1.5.6 Internet Radio

The KEF Connect App offers access to thousands of Internet radio stations from all over the world, offering music, news and discussion.

### 6.1.5.7 Podcasts

The KEF Connect App provides access to a wide range of podcasts covering a huge number of genres and topics.

## 6.1.6 UPnP Playback

You can play compatible music files stored in the music library of a connected media server (e.g. NAS drive via uPnP). The media server must be on the same network as the speakers.

## 6.2 Tips on Choosing Streaming Protocols

Recommendations for the best wireless streaming options with regard to music/media apps on your mobile devices.

App	Wireless streaming protocol					
	AirPlay 2	Chromecast	ROON Ready	Music streaming app native protocol	KEF Connect App	Bluetooth
Spotify	✓	✓	–	Spotify Connect ✓	–	✓
TIDAL	✓	✓	✓	TIDAL Connect ✓	✓	✓
QQ Music	✓	✓	–	QPlay ✓	–	✓
Apple Music	✓	✓	–	–	–	✓
Amazon Music	✓	✓	–	–	✓	✓
Deezer	✓	✓	–	–	✓	✓
Qobuz	✓	✓	✓	–	✓	✓
Internet radio	✓	✓	–	–	✓	✓
Audio podcast	✓	✓	–	–	✓	✓
Youtube (audio)	✓	✓	–	–	–	✓
Youtube Music	✓	✓*	–	–	–	✓

✓ = Supported

✓ = Supported and recommended for the best audio quality and streaming stability.

\*Only available with a Youtube Music Premium account.

# 7. Multi-Room Streaming

## 7.1 AirPlay 2

Apple Airplay 2 can extend the speakers to become part of a multi-room wireless music system which can be controlled with iOS devices. If you have more than one pair of AirPlay 2 speakers connected to the same network, select the pairs for playback of the same audio output at the same time.

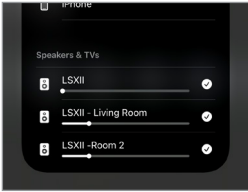

You can control the volume of the speakers individually or together as a group.

Note: Legacy AirPlay (AirPlay 1) speakers are not compatible with multi-room streaming.

For more support, visit [Apple](#).

## 7.2 Chromecast

You can group the speakers and Chromecast devices together for synchronous music throughout the home.

1. Make sure your mobile device is connected to the same Wi-Fi network or linked to the same account as your speakers.
2. Open the Google Home App.
3. At the top left, tap “+” and then “Create a speaker group”.

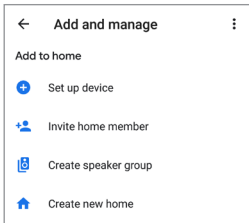

4. Tap each device (including the sets of speakers) you want to add to the group. A check mark will appear next to each device you have selected.

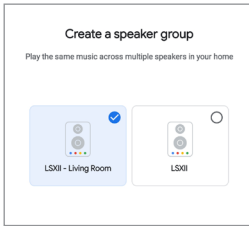

5. Tap "Next"

6. Enter a name for your group.

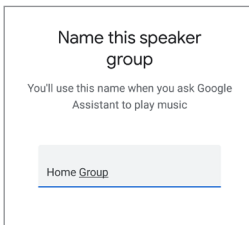

7. Tap "Save".

## 7.3 ROON

With Roon Ready certification, the speakers are compatible with Roon's multi-room streaming functionality.

Roon supports "Zone Grouping", or synchronizing audio playback in several zones within your house. Note that "Zones" can only be grouped with other zones of the same type (e.g. RAAT, AirPlay etc.).

1. To group zones, select the zone you are controlling in desktop and tablet interface, by clicking the "Zone Picker" in the footer, next to volume.

On a phone, select by clicking "Switch Zone" below the volume pop-up.

2. Tap "Group Zones". This brings up the available zones for grouping.



3. Select the desired zone(s) to be added and then tap "Save".

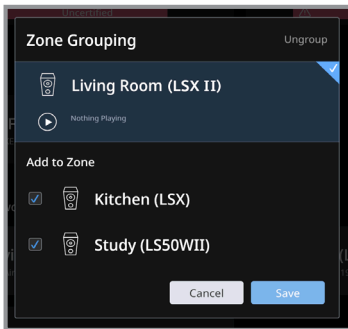

The speakers in the grouped zones will stream the same audio output.

For more support, visit [ROON](https://www.roonlabs.com).

# 8. Voice Control Over Mobile Device

## 8.1 Siri

You can use Siri to control playback (e.g. skipping tracks, controlling the volume level) while your iOS mobile device is streaming music to the speakers.



## 8.2 Google Assistant

You can use Google Assistant to control playback (e.g. skipping tracks, controlling the volume level) while your Android mobile device is streaming music to the speakers.





## 9. Playback with Bluetooth

You can pair your Bluetooth devices (e.g. computers) with the speakers through Bluetooth connection. The speakers must always be first connected to your local network before Bluetooth connection.

### 9.1 Selecting Bluetooth Mode

- In the KEF Connect App, tap the Bluetooth button (📶) to switch to Bluetooth mode.

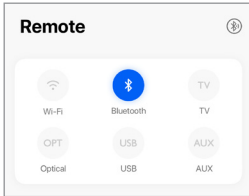

- Alternatively, press the source button on the remote control.



You can assign the Bluetooth mode as a second wake-up source to turn on the speakers automatically when there is audio input through Bluetooth connection. See chapter "[Power Saver – Second Wake-Up Source](#)".

### 9.2 Bluetooth Pairing

1. In Bluetooth mode, check the LED indicator light of the Primary Speaker. When the LED indicator light pulses blue, the speakers are in the discovery mode and ready to pair with a Bluetooth device.

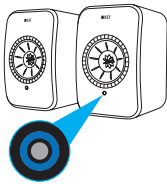

If the LED indicator light illuminates blue briefly and then fades out, the speakers are already paired with a Bluetooth device. To disconnect the connected Bluetooth device, short press the Bluetooth pairing button (B) on the back panel of the Primary Speaker. The Bluetooth icon blinks slowly when it is ready to pair with a new Bluetooth device.

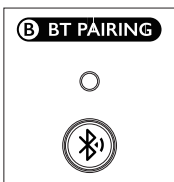

Alternatively, press the Bluetooth pairing icon located at the upper right corner of the remote control in the KEF Connect App to disconnect the paired device.

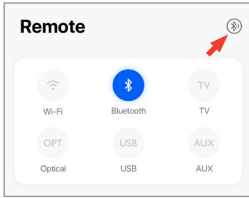

2. Turn on the Bluetooth feature of your device and select “KEF LSX II” (or the name you have created for the speakers) from the list of available devices to pair.

When Bluetooth pairing is done, the Bluetooth icon will stay lit.



The speakers remember your last paired Bluetooth device. Once Bluetooth mode is selected, the speakers will automatically connect with your last paired device if it is around.

## 9.3 Playback Controls

In the KEF Connect App, use the control elements below for playback controls. The volume control, previous and next functions can also be operated on the remote control.

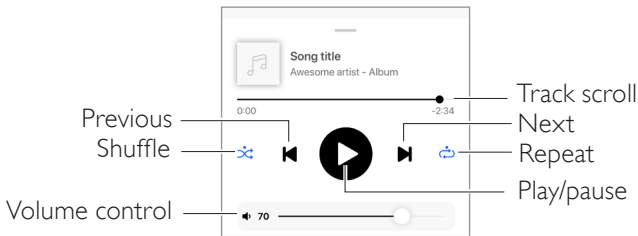

## 10. Playback with HDMI ARC input

The speakers are compatible with HDMI ARC (Audio Return Channel) output from your TV for integrated control through a single HDMI cable. The speakers must always be first connected to your local network before HDMI connection.

The speakers are also backward compatible with HDMI CEC. HDMI CEC allows the use of the television remote control to adjust the volume of the speakers.

### 10.1 HDMI Cable Connection

Connect the HDMI output port of your TV and the TV port (V) on the back panel of the Primary Speaker via an HDMI cable.

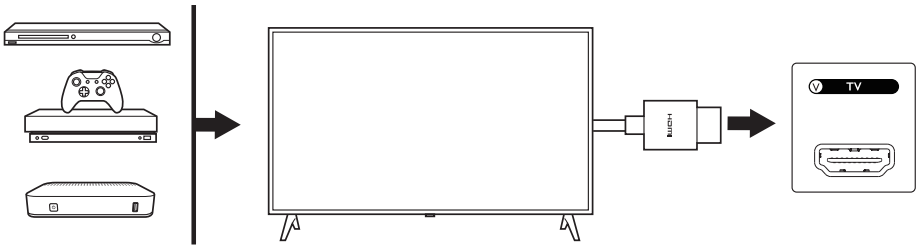

- Connect the HDMI cable to the ARC port of your TV.
- In your TV setting, turn on ARC or CEC in the HDMI settings.
- Refer to the user manual of your TV for details as manufacturers may name the HDMI connections differently (e.g. Anynet+ for Samsung, Simlink for LG).
- Make sure the digital audio output setting for the television is set to PCM (not Dolby, Bitstream, Auto or similar).

## 10.2 Selecting TV Mode

- In the KEF Connect App, tap the TV Mode button (TV) to switch to TV Mode.

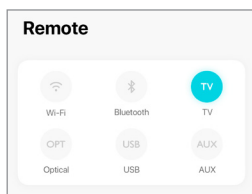

- Alternatively, press the source button on the remote control.
- If no HDMI cable is connected to the speakers and TV mode is selected, the LED indicator light of the Primary Speaker pulses light blue.

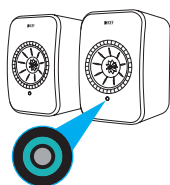

- The LED indicator light of the Primary Speaker illuminates light blue briefly and then fades out when HDMI connection is established.



You can assign TV mode as a second wake-up source to turn on the speakers automatically when there is audio input through the HDMI connection. See chapter "[Power Saver – Second Wake-Up Source](#)".

## 10.3 Playback Controls

All playback controls (except adjusting volume) must be done on the connected device. The volume can also be adjusted on the remote control.

# 11. Playback with Optical Input

You can connect your devices with optical output (e.g. TV and game consoles) to the speakers through an optical cable. The speakers must always be first connected to your local network before optical connection.

## 11.1 Optical Cable Connection

Connect the optical output jack of your device and the optical input jack (O) on the back panel of the Primary Speaker via an optical cable.

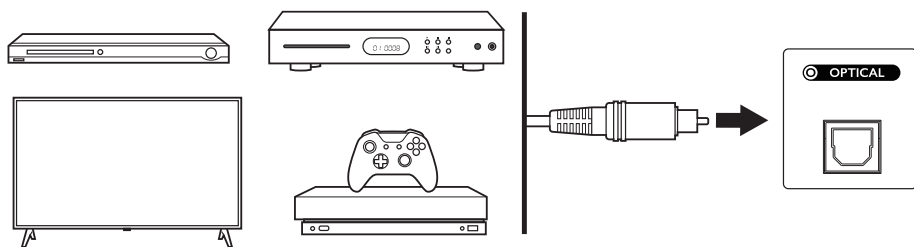

Make sure your TV is set to output digital audio in PCM format. Refer to the user manual of your TV for details.

## 11.2 Selecting Optical Mode

- In the KEF Connect App, tap the Optical Mode button (OPT) to switch to Optical Mode.

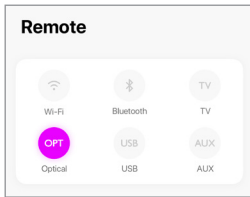

- Alternatively, press the source button on the remote control.
- The LED indicator light of the Primary Speaker illuminates purple briefly and then fades out when Optical mode is selected.

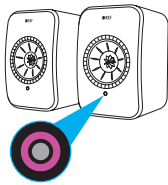

You can assign Optical mode as a second wake-up source to turn on the speakers automatically when there is audio input through the optical connection. See chapter "[Power Saver – Second Wake-Up Source](#)".

## 11.3 Playback Controls

All playback controls (except adjusting volume) must be done on the connected device. The volume can also be adjusted on the remote control.

## 12. Playback with USB Input

You can connect your computer to the speakers through a USB (type C) cable. The speakers must always be first connected to your local network before USB connection.

This feature is compatible with Mac and Windows PC, with a maximum streaming quality of 192 kHz / 24 bit.

Please note that Microsoft has ended support for Windows 7 and Windows 8, and it is recommended to use Windows 10 or above for best USB audio experience.

To adjust the audio resolution of a Mac PC, go to “Utilities > Audio Midi Setup” and select the desired format.

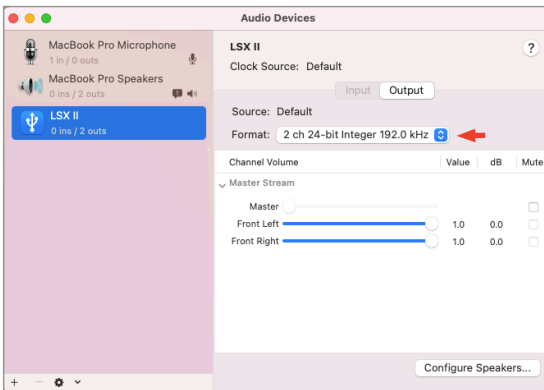

### 12.1 USB Connection

Connect your computer and the USB port (U) on the back panel of the Primary Speaker via a USB cable (type C).

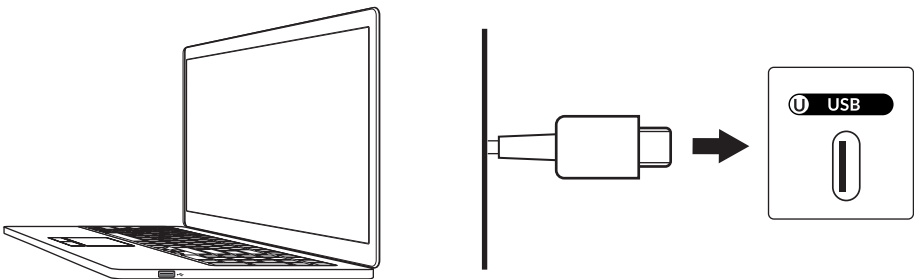

## 12.2 Selecting USB Mode

- In the KEF Connect App, tap the USB button (USB) to switch to USB mode.

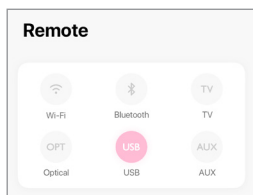

- Alternatively, press the source button on the remote control.
- The LED indicator light of the Primary Speaker illuminates pink briefly and then fades out when USB mode is selected.

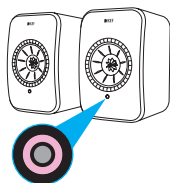

You can assign USB mode as a second wake-up source to turn on the speakers automatically when there is audio input through the USB connection. See chapter: “[Power Saver – Second Wake-Up Source](#).”

## 12.3 Playback Controls

All playback controls (except adjusting volume) must be done on the connected device. The volume can also be adjusted on the remote control.



## 13. Playback with Auxiliary Input

You can connect your devices with 3.5 mm audio output (e.g. turntables, computers, portable music players) to the speakers through an audio cable. The speakers must always be first connected to your local network before auxiliary connection.

### 13.1 Auxiliary Cable Connection

Connect the audio output jack of your device and the auxiliary input jack (X) on the back of the Primary Speaker via a 3.5 mm audio cable.

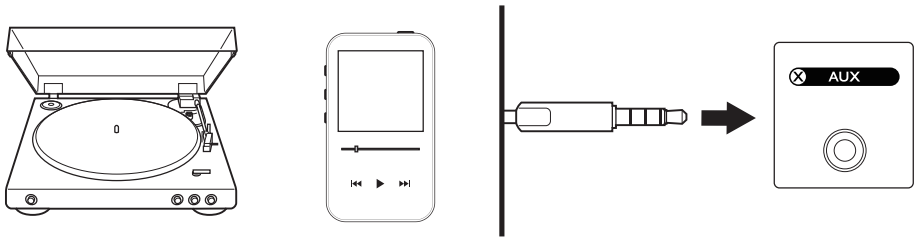

## 13.2 Selecting Auxiliary Mode

- In the KEF Connect App, tap the Auxiliary Mode button (AUX) to switch to Auxiliary mode.

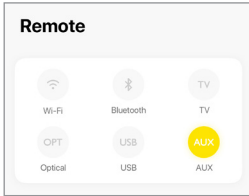

- Alternatively, press the source button on the remote control.
- The LED indicator light of the Primary Speaker illuminates yellow briefly and then fades out when AUX mode is selected.

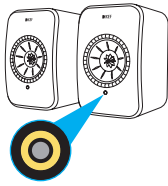

You can assign Auxiliary mode as a second wake-up source to turn on the speakers automatically when there is audio input through the auxiliary connection. See chapter "[Power Saver – Second Wake-Up Source](#)".

## 13.3 Playback Controls

All playback controls (except adjusting volume) must be done on the connected device. The volume can also be adjusted on the remote control.

# 14. Using KEF Connect App

The KEF Connect App allows you to set up the speakers, apply EQ settings, turn on/off the speakers, switch sound sources and access and play back your music streaming services.

## 14.1 Home

### 14.1.1 Overview

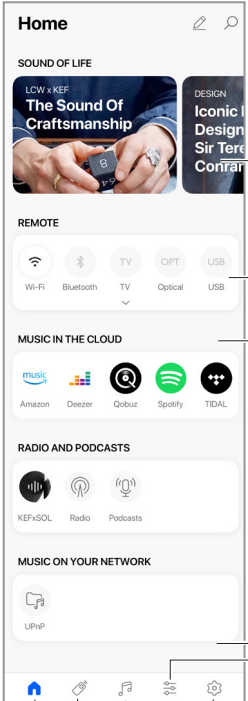

Latest news and stories from KEF

Turn on/off the speakers and switch sources

Shortcuts to music content (music streaming services, Internet radio stations, podcasts and media server\*)

EQ settings

Speaker settings

Music content

Remote control

Home

\*Coming soon

## 14.1.2 Editing the Home Screen

You may edit the Home screen to show or hide tiles (e.g. Music in the Cloud) or buttons that are of frequent or less frequent use.

1. Tap the edit icon (  ) at the top right of the app.
2. Tap the “+” or “-” symbols or drag and drop to show or hide a tile.

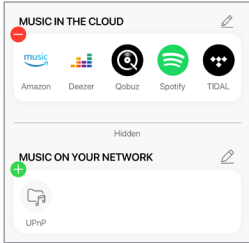

3. Tap the edit icon (  ) at the top right of a tile.
4. Tap the “+” or “-” symbols or drag and drop to show or hide a button in the tile.

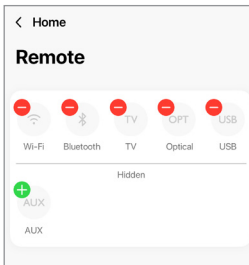

## 14.2 Remote Control

- Use the buttons under “Remote Control” to directly turn on the speakers from that particular source, or change the sound source.

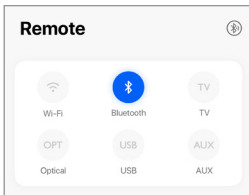

- To turn off the speakers, tap the active source button.

## 14.3 Music Content

The KEF Connect App allows you to access and play back music from your music streaming services as well as Internet radio stations and podcasts.

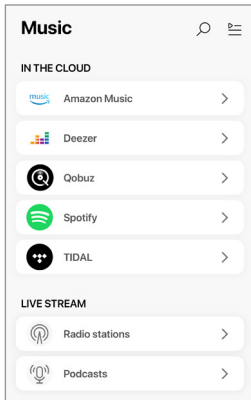

## 14.3.1 Playing Music from Music Streaming Services

### 14.3.1.1 Amazon Music



1. To stream music, tap “Amazon Music” under “Music in the Cloud” in the KEF Connect App.



2. Login to your Amazon Music account.

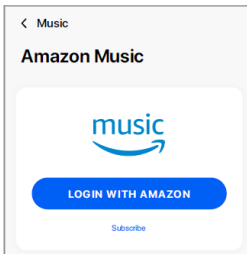

3. Browse and play music to start streaming.

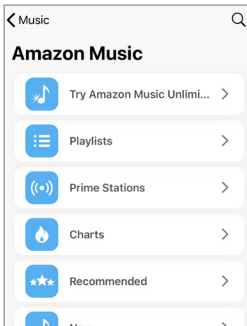

### 14.3.1.2 Deezer



1. To stream music, tap “Deezer” under “Music in the Cloud” in the KEF Connect App.



2. Login to your Deezer account.

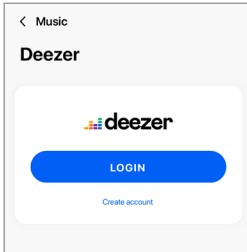

3. Browse and play music to start streaming.

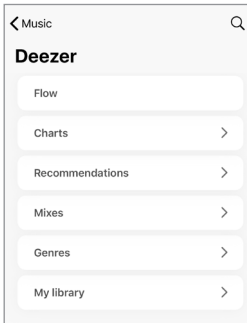

### 14.3.1.3 Qobuz



1. To stream music, tap “Qobuz” under “Music in the Cloud” in the KEF Connect App.



2. Login to your Qobuz account.

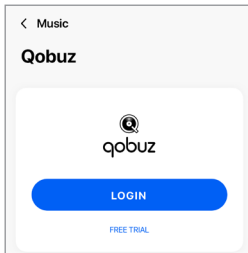

3. Browse and play music to start streaming.

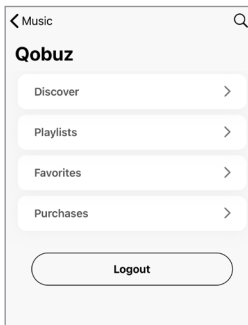

### 14.3.1.4 Spotify



Through the KEF Connect App, you can be prompted to the Spotify App on your device to stream music to the speakers. See chapter “[Spotify Connect](#)”.





### 14.3.1.5 TIDAL



1. To stream music, tap “TIDAL” under “Music in the Cloud” in the KEF Connect App.



2. Login to your TIDAL account.

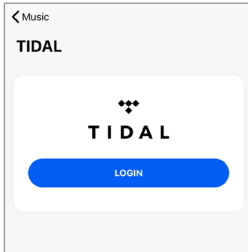

3. Browse and play music to start streaming.

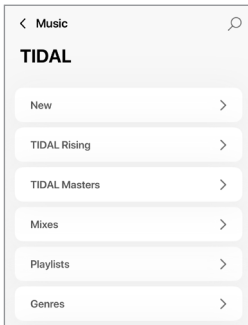

In the KEF Connect App, there is a green or blue dot next to the MQA logo in the Now Playing screen to indicate that the App is decoding and playing an MQA stream or file, and denotes provenance to ensure that the sound is identical to that of the source material. A blue dot indicates the App is playing an MQA Studio file, which has either been approved in the studio by the artist/producer or has been verified by the copyright owner.

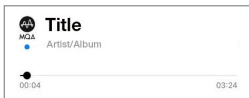

MQA and the Sound Wave Device are registered trade marks of MQA Limited © 2016

### 14.3.1.6 Internet Radio

1. To access Internet radio, tap “Radio stations” under “Live Stream” in the KEF Connect App.

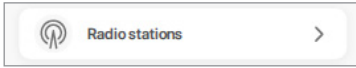

2. Browse and play a radio station to start streaming.

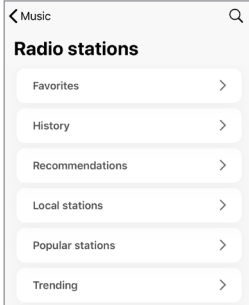

### 14.3.1.7 Podcast

1. To access podcast contents, tap “Podcasts” under “Live Stream” in the KEF Connect App.

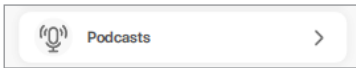

2. Browse and play a podcast to start streaming.

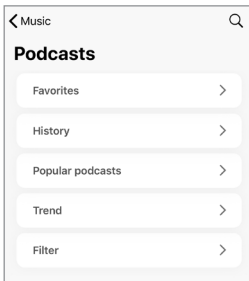

## 14.3.2 Playback Controls

The below features are available to control playback or behaviour. Please note that these features may not be available to all music sources and there may be slight differences in the control interface.

### 14.3.2.1 Playback Screen

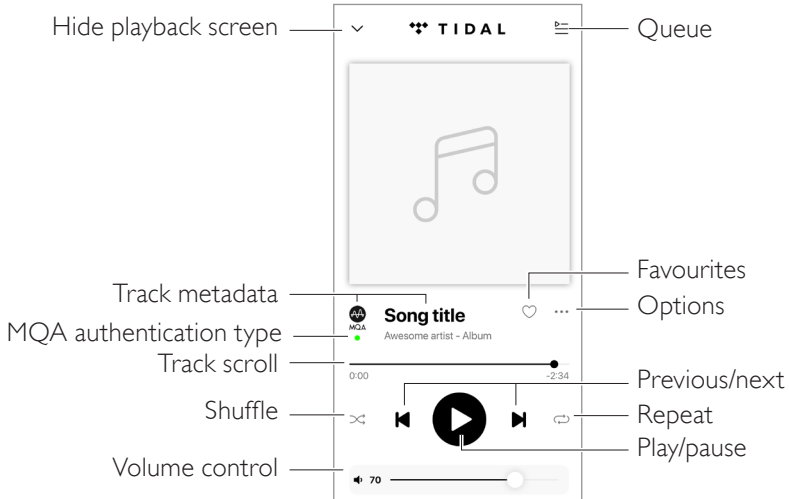

### 14.3.2.2 Search

Tap the search icon (🔍) to look for artists, albums or songs in the current music source.

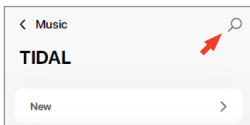

### 14.3.2.3 Favourites

- **Selecting or Deselecting Favourites**

In the playback screen, tap the favourite icon (♥) to select or deselect an item (music, podcast, radio station) as favourites.

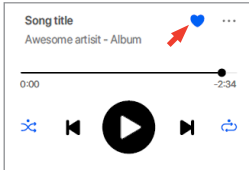

Alternatively, tap the option icon (⋮) next to an item (e.g. track, album, playlist), or press and hold on an item and then select “Add to Favourites” or “Remove from Favourites”.

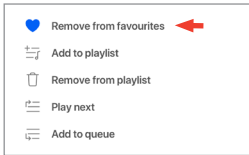

- **Accessing your favourites**

To show the favourites in your current music source, tap “Favourites” in the main menu.



### 14.3.2.4 Playing Queue

Adding a track to the queue means the track will be played after the current playing track. The queue is not permanent and cannot be saved.

- **Adding a Track to the Queue**

1. From the playback screen, tap the option icon (⋮).

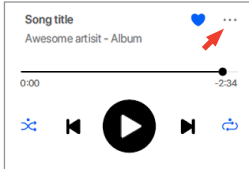

2. Select "Add to Queue" to add the track to the end of the Queue. Or select "Play next" to add the track as the next song.

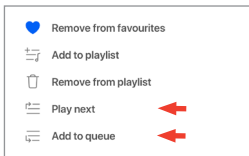

Depending on your selections, you can also add all tracks from an artist, all tracks from an album, or all tracks from a playlist to the queue.

- **Showing the Current Queue**

From the playback screen, tap the queue icon (☰) at the top right.

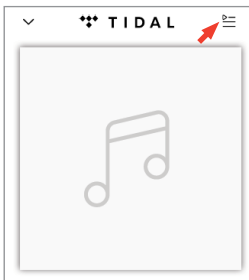

## • Editing the Queue

1. To edit the playback sequence, press and hold the three bars ( ≡ ) on the right hand side of a track and then drag the track up or down the queue.

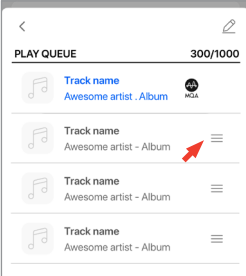

2. To remove a track from the queue, tap the edit icon ( ✎ ) at the top right.



3. Select the track in the queue and then tap the trash bin icon ( 🗑 ) to remove it from the queue. You may also select multiple tracks for removal.

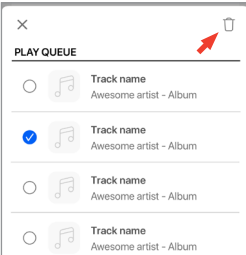

### 14.3.2.5 Playlists

A playlist is a list of tracks that can be played back in the preferred sequential order. Playlists can be saved for future listening.

- **Accessing the Playlists**

In the current music source, tap “Playlists” in the main menu.



- **Creating a Playlist**

1. In the current music source, tap “Playlists” in the main menu.
2. Tap “Create new playlist”.

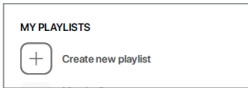

3. Create a name for the playlist and then tap “Create”.

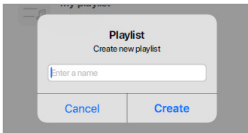

- **Adding Tracks to a Playlist**

1. From a list of tracks or from the playback screen, tap the option icon (⋮) on the right

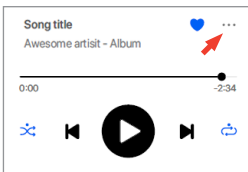

2. Tap “Add to playlist”.

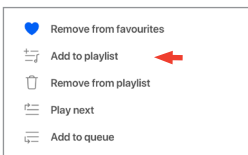

3. Select the playlist you want to add the track to.



Depending on your selections, you can also add all tracks from an artist or all tracks from an album to the playlist.

- **Editing a Playlist**

1. In the playback screen of the track to be removed, tap the option icon (⋮).

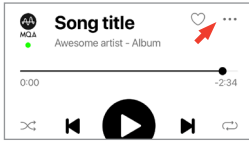

2. Tap “Remove from playlist”.

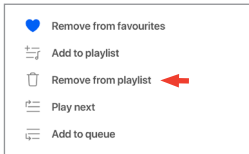

- **Deleting a Playlist**

1. In the playlist, tap the option icon (⋮) at the top right corner.



2. Tap “Delete playlist”.

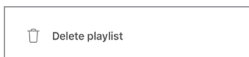



## 14.4 Equalisations

For the best audio performance, apply sound settings according to your listening area.

### 14.4.1 Normal Mode

1. In the KEF Connect App, tap the EQ settings icon (  ) at the bottom of the Home screen.
2. Tap “Add new profile”

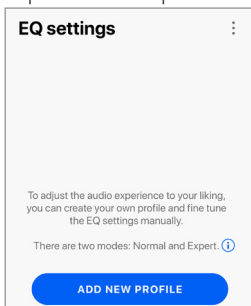

3. Select “Normal mode”.

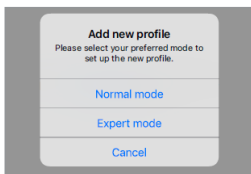

4. Create a name for your new profile and then tap “Save”.

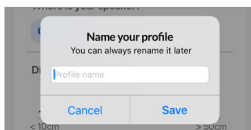

5. Configure the settings according to your listening area.

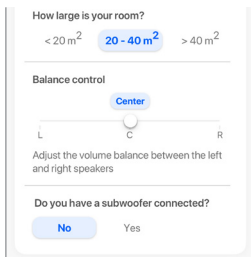
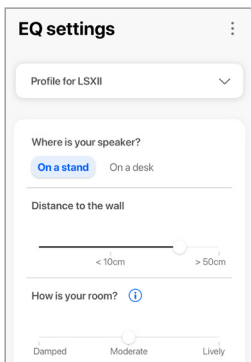

- Installation location: On a stand or on a desk
- Distance from the front edge of the table (on a desk only) (> 50 cm to 0 cm)

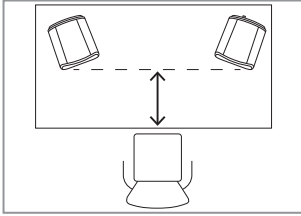

- Distance to the wall (< 10 cm to > 50 cm)

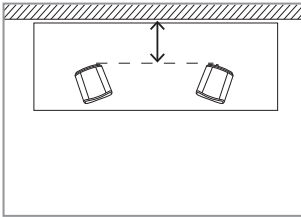

- How is your room? (Damped / Moderate / Lively)

Damped: Large furniture, thick carpet and heavy curtains

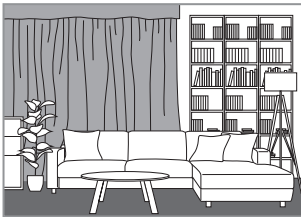

Moderate: Medium furniture, thinner carpet or rug, some curtains and features on walls



Lively: Hard floor, less furniture, large windows and no curtains

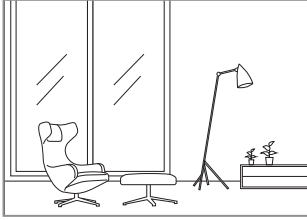

- How large is the room? (< 20 m<sup>2</sup> / 20–40 m<sup>2</sup> / > 40 m<sup>2</sup>)
- Balance Control (L–C–R)
- Subwoofer is plugged in (No / Yes).

If a subwoofer is plugged in, set up the model, balance and volume of the subwoofer.

6. Tap “Save” when the settings are done.

## 14.4.2 Expert Mode

1. In the KEF Connect App, tap the EQ settings icon (  ) at the bottom of the Home screen.
2. Tap “Add new profile”.

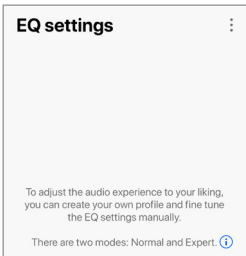

3. Select “Expert mode”.

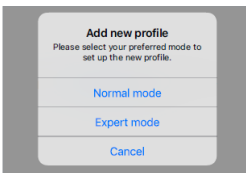

4. Create a name for your new profile and then tap “Save”.

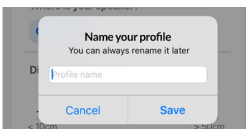

5. The Expert Mode lets you configure the EQ preferences in greater precision.

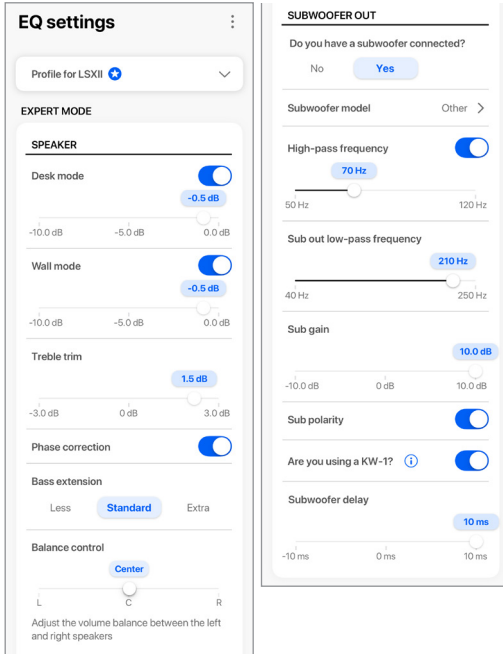

The settings include:

- Desk Mode (On/Off, -10.0 dB to 0.0 dB)
- Wall Mode (On/Off, -10.0 dB to 0.0 dB)
- Treble Trim (-4.0 dB to 4.0 dB)
- Phase Correction (On/Off)
- Bass Extension (Less / Standard / Extra)
- Balance Control (L–C–R)
- Subwoofer model
- High-Pass Frequency (On/Off, 50 Hz to 120 Hz)
- Sub Out Low-Pass Frequency (40 Hz to 250 Hz)
- Sub Gain (-10 dB to 10 dB)
- Sub Polarity (On/Off)
- Are you using a KW-1?
- Subwoofer delay (-10 ms to 10 ms)



## Understanding the EQ Settings

**On a desk/distance from the front edge of the table (Expert Mode: Desk Mode):** This setting adjusts the “presence” region (170 Hz +/- 1 octave). Too much causes a muddy sound, while a lack of presence makes the sound distant and empty.

**Distance to the wall (Expert Mode: Wall Mode):** This setting adjusts all frequencies from around 500 Hz downwards, causing broader changes than Desk Mode. A dip in these frequencies causes a tinny sound, while too much of these frequencies can overwhelm the overall presentation with lower frequencies.

**How is your room? (Expert Mode: Treble Trim):** This adjusts the frequencies above 500 Hz. A damped room (lots of curtains, soft furnishings) can make sound seem muted, while a lively room (high ceiling, flat surfaces, glass) can make it sound harsh. Move towards damped to reduce the muting effect, or move towards lively to tame harshness.

**How large is your room (Expert Mode: Bass Extension):** This setting adjusts the bass extension of the speakers. The larger the room selected, the lower the roll-off point.

**Balance Control:** This setting allows you to adjust the volume balance between the left and right channels.



## Understanding the Subwoofer Settings

**Subwoofer/Speaker Balance (Basic Mode):** This controls the bass output between the subwoofer and the speakers. If the slider is moved more to “Subwoofer”, most of the bass output will be handled by the subwoofer.

**High-Pass Frequency:** Frequencies above the set point will be played by the speakers.

**Sub Out Low-Pass Frequency:** Frequencies below the set point will be handled by the subwoofer. This can overlap with the high-pass frequency to help integrate the speaker/subwoofer more effectively with no dip or peak in overall response.

**Sub Gain:** This changes the signal level output to the subwoofer.

**Sub Polarity:** Ideally, the speakers and subwoofer should be moving in the same direction at the same time, otherwise frequencies can be cancelled out. Switching the polarity of the subwoofer can resolve a perceived lack of bass response.

**Are you using a KW-1?:** KW-1 is a subwoofer adapter kit which transmits signals wirelessly, enabling your subwoofer to be optimally placed. Enable this option if you are using KW-1.

### 14.4.3 Selecting a Sound Profile

1. In the KEF Connect App, tap the EQ settings icon (  ) at the bottom of the Home screen.
2. Tap “Default” and then select a sound profile to apply to the speakers. The profiles with a star icon are created in Expert mode.

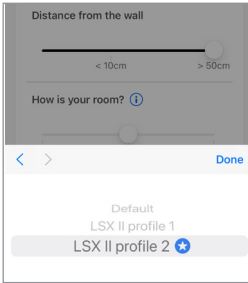

### 14.4.4 Renaming a Sound Profile

1. In the selected EQ profile, tap the option icon (  ) at the top right.

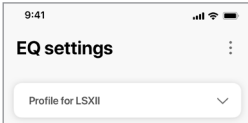

2. Tap “Rename profile”.

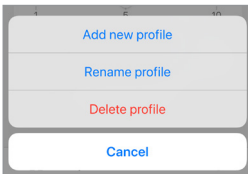

3. Create a new name for your profile and then tap “Save”.

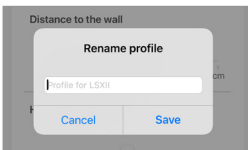

## 14.4.5 Deleting a Sound Profile

1. In the selected EQ profile, tap the option icon (⋮) at the top right.

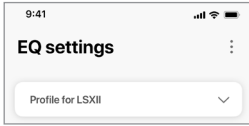

2. Tap "Delete profile".

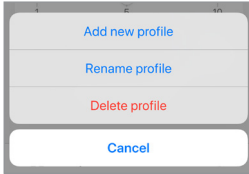

## 14.5 Profile

This menu allows you to edit your personal details (account name and profile picture) of your registered user account.

1. In the KEF Connect App, tap the Setting icon (⚙️) at the bottom of the Home screen.
2. Tap “View profile”.

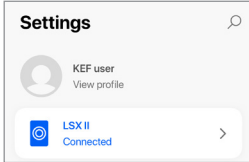

3. Tap the edit icon (✎) at the top right and start editing.

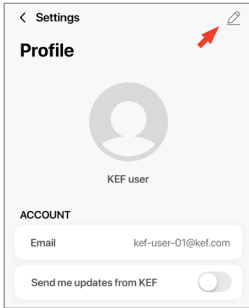



## 14.6 Choosing Your Speaker

### 14.6.1 My Speaker and Speakers Nearby

This menu allows the KEF Connect App to switch to another pair of speakers for control and streaming. All speakers must first be set up through the same KEF Connect App before they are available for selection.

1. In the KEF Connect App, tap the Setting icon (⚙️) at the bottom of the Home screen.
2. Tap the name of the connected speakers.

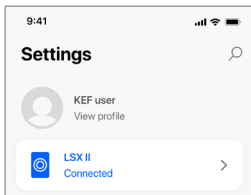

3. Select another pair of speakers for control and streaming.

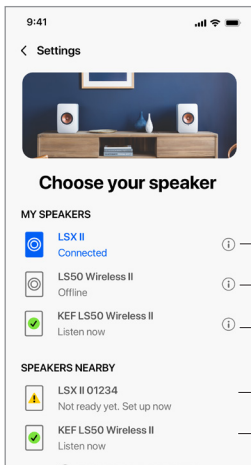

- ① — Current speakers
- ① — Speakers on the same network but turned off
- ① — Speakers on the same network and ready for switching
- Not set up yet with KEF Connect App
- Already set up with KEF Connect App on another mobile device



The speakers under “Speakers Nearby” are on the same network but not ready yet to be controlled through the KEF Connect App on your mobile device.

## 14.6.2 Speaker Info

This menu allows you to find out more information about the connected speakers, rename the speakers and disconnect the speakers from the KEF Connect App.

1. In the KEF Connect App, tap the Setting icon (⚙️) at the bottom of the Home screen.
2. Tap the name of the connected speakers.

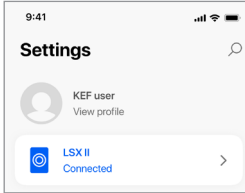

3. Tap the info icon (ⓘ) next to the name of the speakers.

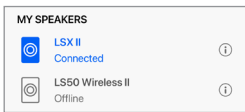

4. Check the MAC address, IP address and firmware version of the speakers. You can also rename the speakers or forget the speakers (disconnect them from the KEF Connect App).

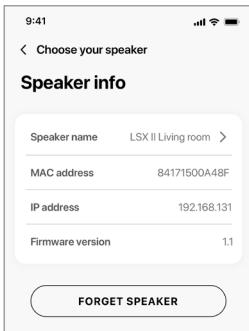

## 14.7 Speaker Preferences

This menu allows you to configure various speaker preferences. To access this menu:

1. In the KEF Connect App, tap the Setting icon (⚙️) at the bottom of the Home screen.
2. Tap “Speaker preferences”.



### 14.7.1 Power Saver – Standby Mode

This setting determines how long (ECO (20), 30 or 60 mins) the speakers will remain idle before automatically entering Standby Mode. If “never” is selected, the speakers must be manually turned off.

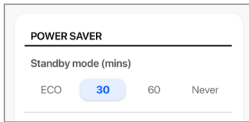

### 14.7.2 Power Saver – Second Wake-Up Source

This setting enables a second source to automatically turn on the speakers when there is audio input from the selected source. This option is not available when Standby Mode is set to ECO.

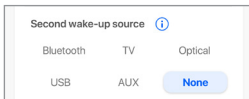

### 14.7.3 Do Not Disturb – Standby LED

This setting enables the LED indicator light to turn off when the speakers are in Standby mode.

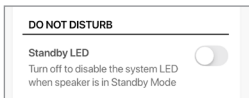

## 14.7.4 Do Not Disturb – Start Up tone

This setting enables the start up tone to be muted when the speakers are turned on.



## 14.7.5 Speaker System Options – Cable Mode

You can connect the Primary Speaker and Secondary Speaker with the provided interspeaker cable through the “T” connection ports on the back panels of the speakers. Once the cable is connected, enable this setting to enable Cable mode and disable the wireless connection.

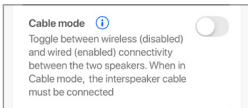

Cable Mode is required/recommended when:

- You prefer a higher resolution at 96 kHz/24 bit (wireless: 48 kHz/24 bit).
- You are experiencing audio dropouts due to interference.

## 14.7.6 Speaker System Options – Inverse L/R Speakers

This setting changes which speaker plays left and right. By default, the Primary Speaker plays the right channel.

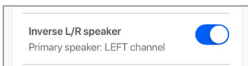

## 14.7.7 KW-1 Power Mode

This setting switches the USB port of the Primary Speaker from audio input to power output. Turn on this setting to enable the KW-1 transmitter to be power by the speakers. Note that USB audio input will be disabled when this setting is turned on.



## 14.8 Volume

This menu allows you to configure volume settings. To access this menu:

1. In the KEF Connect App, tap the Setting icon (⚙️) at the bottom of the Home screen.
2. Tap “Volume”.



### 14.8.1 Volume Display Setting

This setting allows you to configure how the volume control should be displayed.

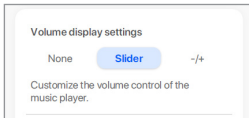

- None: No volume control will be displayed during playback.
- Slider: The volume control will be displayed as a slider for adjustment.



Tap the speaker icon on the left to mute or restore audio output from the speakers.



- -/+ : The volume control will be displayed as “-” and “+” buttons for adjustment.



Tap the speaker icon in the middle to mute or restore audio output from the speakers.



## 14.8.2 Hardware Volume

This setting is only available on iOS devices. The hardware volume buttons refer to the physical volume buttons on your device. Disable this setting when you are experiencing conflicts with other music streaming apps over Wi-Fi connection.



## 14.8.3 Speaker Volume Sensitivity

This setting allows you to configure the number of volume steps for each single press of the physical volume buttons of your device.

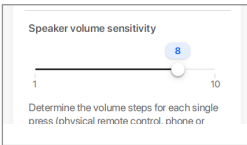

## 14.8.4 Maximum Volume

This setting allows you to configure the maximum level when adjusting the volume. The setting applies to all sources.

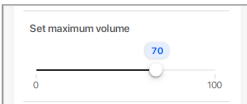

## 14.9 Performance

This menu allows you to configure the streaming settings and assess your network quality. To access this menu:

1. In the KEF Connect App, tap the Setting icon (⚙️) at the bottom of the Home screen.
2. Tap “Performance”.

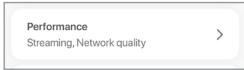

### 14.9.1 Streaming Settings – Audio Quality

This setting allows you to select the audio quality for music streaming services inside the KEF Connect app.

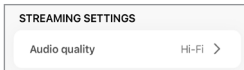

- Hi-Fi (Hi-Fi quality): Always select this setting for the best audio quality. The highest quality depends on the music streaming service and your subscription.
- High (CD quality): Select this setting when the speakers are in a crowded network and experiencing quality drop-outs.
- Normal (MP3 quality): Select this setting when the speakers are in a crowded network and experiencing audio drop-outs.

### 14.9.2 Network quality

This setting allows you to assess your network quality. For details, see chapter “[Speaker Connection Test](#)”.

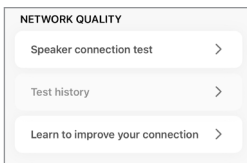

- Speaker connection test: Select this option to perform a network quality check.

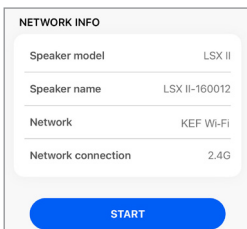

- Test history: Select this option to review the test history.

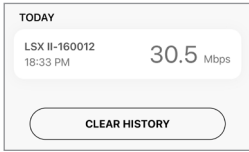

- Learn to improve your connection: Select this option to access the KEF website for tips on assessing and improving your network quality.



## 14.10 Firmware Upgrade

### 14.10.1 Automatic Firmware Update after Onboarding

After you have successfully set up the speakers with the KEF Connect App, you may be required to update the firmware if a new version is available. Follow the instructions in the KEF Connect App to complete the update process.

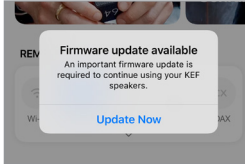

### 14.10.2 Automatic Firmware Check

The speakers check the server every 4 hours if a new firmware update is available. If a firmware is available, it will check if the firmware update is compulsory or not.

If a firmware update is compulsory, it will start the update when:

- The speakers are in standby mode, or
- The Wi-Fi source or Bluetooth source has been idle for 60 minutes.

If a firmware update is not compulsory, it will be carried out when:

- The speakers are in standby mode between 2–3 am, or
- The Wi-Fi source or Bluetooth source has been idle for 60 minutes.

A firmware update will not occur when the speakers are in use.

### 14.10.3 Manual Firmware Update

This menu allows you to manually check for firmware updates.

To access this menu:

1. In the KEF Connect App, tap the Setting icon (  ) at the bottom of the Home screen.
2. Tap “Speaker update”.



3. If an update is available, tap “Update now” to proceed with the firmware update.

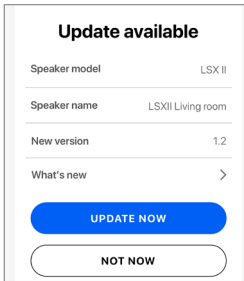

## 14.11 Application

This menu allows you to reset the home screen and send analytics.

To access this menu:

1. In the KEF Connect App, tap the Setting icon (⚙️) at the bottom of the Home screen.
2. Tap “Application”.

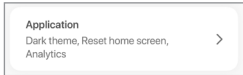

### 14.11.1 Theme Settings – Theme

This setting allows you to set a theme mode (System, Light or Dark).



### 14.11.2 Theme Settings – Reset Home Screen

This setting allows you to reset the Home screen of the app to default settings.

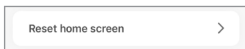

### 14.11.3 Analytics – Improve App/Speaker

This setting allows the KEF Connect app to anonymously send improvement analytics to KEF. We recommend this setting is enabled to help KEF to improve product performance

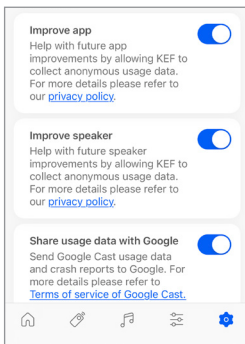

## 14.12 Support

This menu allows you to report issues, give suggestions and make general enquiries.

To access this menu:

1. In the KEF Connect App, tap the Setting icon (⚙️) at the bottom of the Home screen.
2. Tap "Support".



3. Select the type of support you need and proceed as instructed on the screen.

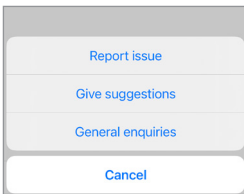

4. When reporting an issue, your email program will automatically attach the speaker logs that helps KEF investigate the issue. Please add a description of the problem in the email message as well.

A screenshot of the "Support" form in the KEF Connect App. The form is divided into two main sections. The left section contains a dropdown menu for "Report issue" (set to "Report issue"), and several fields for device information: "Speaker model" (LSX II), "Firmware version" (1.1), "App version" (1.3.2), "OS version" (iOS 14.4), "Device name" (iPhone 11), and "Country/Region" (Hong Kong). Below these is a section titled "Issue encountered\*" with a text input field. The right section is titled "Steps to reproduce the issue" and contains a text input field. Below that is an "Attach file" section with a plus sign icon, showing three attached files: a LOG file, a JPG file, and an MP4 file. At the bottom of this section is a checkbox labeled "I would like to be contacted by support." and a "SUBMIT" button.

## 15. Cleaning and Maintenance

### **⚠ WARNING!**

#### **Risk of electric shock!**

Improper cleaning of the speakers may result in injury.

- Always unplug the power cables from the power sockets/outlets before cleaning the speakers.

### **NOTICE!**

#### **Risk of short circuit!**

Water and other liquids that have penetrated the housing may cause a short circuit.

- Make sure that no water or other liquids penetrate the housing of the speakers.
- Never immerse the speakers in water or other liquids.

### **NOTICE!**

#### **Risk of damage!**

Improper handling of the speakers may result in damage.

- Do not use any aggressive cleaners, brushes with metal or nylon bristles, or sharp or metallic utensils such as knives, hard scrapers and the like. They could damage the surface.

1. Disconnect the power cables of the speakers from the power sockets/outlets before cleaning.
2. Clean the surfaces of the speakers with a clean lint-free cloth. If necessary, use an alcohol-free cleaner (e.g. screen cleaner, eyeglass lens cleaner) to remove stubborn stains.
3. To clean the Uni-Q drivers (speaker cones), use an anti-static cleaner and a soft sponge. Be careful as the driver may be damaged if too much force is used.

## 16. Disposal

### 16.1 Disposing of the Packaging

Sort the packaging before you dispose of it. Dispose of paperboard, cardboard and wrappings in accordance with your local guidelines.

### 16.2 Disposing of the Speakers

**Old appliances may not be disposed of in the household waste!**

LSX II is an electronic product and may not be able to be disposed of as household waste. Please dispose of your speaker in accordance with the regulations in force in your city or county. This ensures that old appliances are recycled in a professional manner and reduces negative consequences.

### 16.3 Disposing of the Battery

**Batteries may not be disposed of with household waste!**

As the end user you are required by law to bring all batteries, regardless whether they contain harmful substances\* or not, to a collection point run by the communal authority or to a retailer, so that they can be disposed of in an environmentally friendly manner.

\* labeled with: Cd = cadmium, Hg = mercury, Pb = lead

# 17. FAQ and Troubleshooting

## 17.1 Set-up

### 1. How do I set up the speakers?

- First of all, a home Wi-Fi network is required. This is to ensure you can enjoy the full range of features and keep the system up to date.
- Then, download the KEF Connect App from the App Store or Google Play Store and install it on your mobile device. Follow the instructions in the KEF Connect App to get the speakers connected (onboarded) to your home Wi-Fi network.

### 2. What router specifications do the speakers support?

- IEEE 802.11 a/b/g/n/ac, IPv4, IPv6, Dual-band 2.4 GHz / 5 GHz
- For better streaming stability, especially on hi-resolution music files, a 5 GHz Wi-Fi network with a router transmission speed of at least 1300 Mbps is recommended.
- Office, hotel, guest and public networks often feature additional security or authentication methods which may prevent the speakers from connecting. You may need the help of the network administrator to configure the network to allow full functionality if using these kinds of networks.
- LTE routers/mobile hotspots will work, but may also consume a significant amount of battery power and mobile data.

### 3. Can I use a mesh router?

- Yes, we have tested the most popular mesh routers and they are working well with the speakers. However, as there is not yet an industrial standard for mesh routers, each manufacturer may have their own meshing technology. If your mesh router does not work with the speakers, make sure you have updated your router to the latest firmware or contact the manufacturer for solutions.

### 4. How far apart can I place the two speakers?

- Wireless: up to 8 meters apart depending on your network condition. A congested network environment will have more interferences and may reduce this distance.
- Wired: Cable length up to 10 meters.
- Optimal listening distance between the speakers and the listener will depend on how far the Primary Speaker and Secondary Speaker are separated from each other. Try to aim for approximately the same distance between the Primary Speaker and Secondary Speaker and between the speakers and the listener.

### 5. How large a room can the speakers cover?

- 10–100 m<sup>2</sup>

## 6. Can I change the Primary Speaker as the left channel?

- By default, the Primary Speaker is the right channel and the Secondary speaker is the left channel. After connecting the speakers to your home Wi-Fi network, you can [invert the L/R channels](#) in the KEF Connect App.

## 7. Do I need to pair the two speakers?

- No, the two speakers are already paired at the factory. If you do not hear any sound from the Secondary Speaker, see chapter "[Troubleshooting](#)".

## 8. What is the purpose of the ethernet cable in the packaging box?

- Use this inter-speaker cable to connect the Primary Speaker and Secondary Speaker if you prefer a higher sound resolution (96 kHz/24 bit), or if the wireless connection between the speakers is not stable. After connecting the inter-speaker cable, you must also enable [Cable Mode](#) in the KEF Connect App.

## 9. Can I rename the speaker?

- Yes, [renaming](#) can be done in the KEF Connect App. This will change the name for both Wi-Fi and Bluetooth connections.



## 17.2 Playback and Streaming

### 1. Which is the best wireless streaming option for different apps?

- Recommendations for the best wireless streaming options with regard to music/media apps on your mobile devices.

App	Wireless streaming protocol					
	AirPlay 2	Chromecast	ROON Ready	Music streaming app native protocol	KEF Connect App	Bluetooth
Spotify	✓	✓	–	Spotify Connect ✓	–	✓
TIDAL	✓	✓	✓	TIDAL Connect ✓	✓	✓
QQ Music	✓	✓	–	QPlay ✓	–	✓
Apple Music	✓	✓	–	–	–	✓
Amazon Music	✓	✓	–	–	✓	✓
Deezer	✓	✓	–	–	✓	✓
Qobuz	✓	✓	✓	–	✓	✓
Internet radio	✓	✓	–	–	✓	✓
Audio podcast	✓	✓	–	–	✓	✓
Youtube (audio)	✓	✓	–	–	–	✓
Youtube Music	✓	✓*	–	–	–	✓

✓ = Supported

✓ = Supported and recommended for the best audio quality and streaming stability.

\*Only available with a Youtube Music Premium account.

### 2. Can I stream audio output from Youtube, Netflix and other media contents to the speakers?

- You can stream through AirPlay, Chromecast or Bluetooth. Subject to changes according to the platforms.

### 3. Is the subwoofer output mono or stereo?

- The output is mono.

### 4. How should I set the speakers if I prefer to adjust the volume on an external equipment (preamplifier, streamers/multi-room systems) rather than through the KEF Connect App?

- In the KEF Connect App:
  - 1) In Settings, go to “Volume”, change “Volume Display” to “-/+”
  - 2) Select the relevant source input.
  - 3) Change the volume to 71. The source selection is now set to “Unity gain”.

## 17.3 Troubleshooting

### 1. What should I do to set up the speakers to another network?

- A factory reset is necessary. This will clear the previous network settings and all EQ and system preferences. For this purpose, press and hold the Reset button (R) on the back panel until the LED light above the button blinks.

### 2. What should I do if I cannot find my speakers in the network during set-up?

- Make sure the LED light of the Primary Speaker is blinking white and amber. The speakers are ready to connect to a Wi-Fi network.
- Wait for about 30–40 seconds for the speakers to be visible on the speaker list.
- If you still cannot see the speakers, make sure your mobile device, the speakers and the router are within line of sight (the closer the better).
- The speakers broadcast on Channel 2 (2.4 GHz band). If your router overlaps this channel, it may cause issues with discoverability and connection. Go to your router settings and configure the 2.4 GHz channel to avoid overlapping with Channel 2.

### 3. How do I report a bug or an issue?

- In the KEF Connect App, go to “Settings” > “Support”. To let us better understand the bug or issue, please provide a descriptive report.

### 4. There is no sound from both speakers.

- Check if the speakers are already turned on and not muted.
- Make sure you are playing the correct set of speakers and have selected the correct sound source.
- Check the volume level, you may need to turn up the volume.

### 5. There is dropout from both speakers.

- A congested network environment reduces bandwidth for music streaming, you need to set up the speakers to a less crowded router channel.
- Check if there is a network problem. Perform the [speaker connection test](#) in the KEF Connect App.
- Change the [audio streaming quality](#) in the KEF Connect App to a lower resolution.
- A congested network or multiple wireless devices lead to high interference. Try to minimize the interference around the speakers. If the problem persists, connect the internet port of the speakers to the router.

## 6. There is no sound from the Secondary Speaker.

- Make sure the Secondary Speaker is connected to power.
- Check if the connection between the two speakers is lost (the LED indicator light of the Primary Speaker is blinking white and blue).

If the connection is lost, short press the P/S pairing button (P) on the back panel of the Primary Speaker to re-establish the connection. Wait a while until the connection is established. **Note:** Do not press the button for more than 1 second.

- If the problem persists, connect the speakers with the inter-speaker cable and turn on Cable Mode in the KEF Connect App.

## 7. There is dropout from the Secondary Speaker.

- If the speakers are connected wirelessly, try to move them closer to each other.
- If the problem persists, connect the speakers with the inter-speaker cable and turn on Cable Mode in the KEF Connect App.
- A congested network or multiple wireless devices lead to high interference. Try to minimize the interference around the speakers.

## 8. The audio is out of sync with the picture when using the speakers with a TV.

- If available, try the video delay/lip sync function of your TV.
- Use HDMI/optical input, and try to avoid Bluetooth connection. There is an inherent delay in the Bluetooth codec.

## 9. I have connected the speakers to the TV with an HDMI cable, why is there no sound?

- Make sure the source is switched to TV for the speakers.
- If the LED indicator light of the Primary Speaker is blinking light blue, the HDMI connection is not found. In this case, make sure that the HDMI cable is connected to the ARC port of the TV.

If the LED indicator light of the Primary Speaker is pulsing light blue, only CEC (not ARC) connection is established (TV may respond without sound). In this case, do the following:

- The HDMI CEC connection needs to be enabled on the TV. As manufacturers may name this connection differently (e.g. Anynet+ for Samsung, Simplink for LG), please check the user manual of your TV on how to turn on HDMI connection for your TV. Once the HDMI CEC connection is enabled, the LED indicator light of the Primary Speaker illuminates light blue briefly and then fades out (both CEC and ARC connections are now established).

- If there is only no sound but everything else is working, please make sure that the audio output of HDMI is set to PCM (this is often set to Dolby Digital by default). As the settings menu of each TV manufacturer is different, please refer to the user manual of your TV. Also check the settings within the application in use (e.g. Netflix and Disney+) and make sure PCM is selected.
- Change the HDMI cable (our internal tests found that HDMI cables of lower quality may not be able to establish the connection) and make sure the HDMI cable is properly connected.
- As a last resort, power cycle the TV (unplug the power cable from the TV and wait about 10-15 seconds before plugging it back in) and try again. Smart TVs are like phones and sometimes require a reboot.
- If the problem persists, please report the issue in the Support section of the KEF Connect App for investigation. In the meantime, use the Optical connection as a fall-back solution.

#### **10. I have connected the speakers to the TV with an optical cable, why is there no sound?**

- Make sure your TV is set to output digital audio in PCM format.
- If the problem persists, try a different optical cable or connection option (e.g. HDMI).

#### **11. I cannot find a radio station or podcast in the KEF Connect App.**











- We are constantly updating and expanding our database for radio stations and podcasts. Please use the Support function in the KEF Connect App and send us the RSS link of the website. After verification, we will add it to our database.













#### **12. I cannot adjust the speaker volume.**





- Check if you have set a maximum level for volume adjustment.
- Check if you are connecting and controlling the correct set of speakers in the network.

## 17.4 LED Indicators



The connection and operation status can be easily checked through the colours and patterns of the LED indicator lights on the Primary and Secondary Speakers. Refer to the table below.

Speaker	Pattern	Status
Primary	 Blinking white and amber	LSX II is ready to connect to a Wi-Fi network. Launch the KEF Connect app to set up the speakers.
Primary	 Pulsing amber	The speakers are in Standby Mode and trying to connect to a Wi-Fi network.
Primary	 Solid amber*	The speakers are in Standby Mode and connected to the Wi-Fi network.
Primary	 Blinking amber	<p>The speakers are unable to connect to a Wi-Fi network.</p> <ul style="list-style-type: none"> <li>• Make sure your router is turned on.</li> <li>• Move the Primary Speaker closer to the router. If the problem persists, connect the Primary Speaker to your router by a LAN cable.</li> <li>• If this happens right after the network connection, it is likely that the Wi-Fi password is incorrect. Perform factory reset (Press and hold the Reset button (R) on the Primary Speaker until the LED light above the button blinks) and try the connection process again.</li> </ul>
Primary	 Solid white*	The speakers are operating in Wi-Fi mode.
Primary	 Solid green*	The speakers are operating in Spotify Connect Mode.
Primary	 Solid blue*	The speakers are operating in Bluetooth Mode and a device is already paired with the speakers.
Primary	 Pulsing blue	The speakers are in the Bluetooth discovery mode and are ready to pair with a Bluetooth device.
Primary	 Solid light blue*	The speakers are operating in TV Mode.
Primary	 Pulsing light blue	The speakers are connecting to a TV.

Speaker	Pattern	Status
Primary	 Blinking light blue	The speakers are not connected to a TV.
Primary	 Solid purple*	The speakers are operating in Optical Mode.
Primary	 Solid pink*	The speakers are operating in USB Mode.
Primary	 Solid yellow*	The speakers are operating in AUX Mode.
Primary	 Blinking white slowly	The speakers are muted in Wi-Fi Mode.
Primary	 Blinking blue slowly	The speakers are muted in Bluetooth mode.
Primary	 Blinking light blue slowly	The speakers are muted in TV Mode.
Primary	 Blinking purple slowly	The speakers are muted in Optical Mode.
Primary	 Blinking pink slowly	The speakers are muted in USB Mode.
Primary	 Blinking yellow slowly	The speakers are muted in AUX Mode.
Primary	 Blinking white and blue	<p>The Primary Speaker is in wireless pairing mode searching for the Secondary Speaker.</p> <ol style="list-style-type: none"> <li>1. Make sure Cable Mode is disabled on the KEF Connect app (Settings &gt; Speaker preferences &gt; Cable mode).</li> <li>2. On the Secondary Speaker, press the (P) P/S Pairing button once. The Secondary Speaker will search for the Primary Speaker for reconnection.</li> </ol>
Primary and Secondary	 Blinking light blue and yellow	<p>Cable Mode is enabled and the connection between the speakers is interrupted.</p> <ol style="list-style-type: none"> <li>1. Make sure the inter-speaker cable is connected between the Primary Speaker and Secondary Speaker.</li> <li>2. Make sure the inter-speaker cable is inserted in the correct connection ports: "(T) To P/S" on the Primary Speaker and Secondary Speaker.</li> </ol>
Secondary	No LED light	The Secondary Speaker is operating normally.

Speaker	Pattern	Status
Secondary	 Blinking white and blue	<p>The Secondary Speaker is in the wireless pairing mode searching for the Primary Speaker.</p> <ol style="list-style-type: none"> <li>1. Make sure Cable Mode is disabled on the KEF Connect app (Settings &gt; Speaker preferences &gt; Cable mode)</li> <li>2. On the Primary Speaker, press the (P) P/S Pairing button once. The Primary Speaker will search for the Secondary Speaker for reconnection.</li> </ol>
Primary and Secondary	 Blinking red quickly	<p>System error.</p> <ol style="list-style-type: none"> <li>1. Pull the power cables from both speakers.</li> <li>2. Wait approximately 60 seconds.</li> <li>3. Plug the power cables back to both speakers.</li> <li>4. The LED indicator of the Primary Speaker should be pulsing amber, indicating that the speakers are attempting to connect to the network.</li> </ol> <p>If the problem persists, please contact your KEF dealer.</p>
Primary and Secondary	 Blinking red and amber slowly	Overheat protection is activated.
Primary and Secondary	 Blinking white, blue, light blue, purple, pink and yellow alternately	The firmware is being updated. Do not unplug the power cables until the firmware update is completed. If you encounter any issues during the firmware update, do not interrupt the process and contact your local representative or contact your local KEF dealer.



Speaker	Pattern	Status
Primary and Secondary	 Blinking red slowly	<p>The firmware update process failed.</p> <ol style="list-style-type: none"> <li>1. Unplug the power cables from both speakers.</li> <li>2. Wait approximately 60 seconds.</li> <li>3. Plug the power cables back to both speakers.</li> <li>4. Perform the firmware update again on the KEF Connect App.</li> </ol> <p>If the problem persists, please send a log from the KEF Connect App (Settings &gt; Support &gt; Report issue).</p>
Primary	 Blinking red and light blue slowly	The Secondary Speaker is missing during firmware update.

\*The LED indicator light illuminates briefly and fades out when there are no active interactions with the speakers (e.g. controlling playback or volume).

# 18. Appendix

## 18.1 Specifications

Model	LSX II
Drive units	Uni-Q Driver Array: HF: 19 mm (0.75 in.) aluminium dome LF/MF: 115 mm (4.5 in.) magnesium/aluminium alloy cone
Frequency range (-6 dB) measured at 85 dB/1 m	49 Hz – 47 kHz *Depends on EQ settings
Frequency response ( $\pm 3$ dB) measured at 85 dB/1 m	54 Hz – 28 kHz *Depends on EQ settings
Amplifier output power (per speaker)	LF: 70 W HF: 30 W
Amplifier class (per speaker)	LF: Class D HF: Class D
Max SPL measured at 1m	102 dB
Wireless streaming features	AirPlay 2 Google Chromecast ROON Ready UPnP Compatible Bluetooth 4.2
Streaming services	Spotify via Spotify Connect Tidal via Tidal Connect Amazon Music Qobuz Deezer QQ Music via QPlay Internet Radio Podcast *Depends on services availability in different countries
Source resolution	Network up to 384 kHz/24 bit Optical up to 96 kHz/24 bit USB Type C up to <b>192 kHz/24 bit</b> HDMI up to <b>1.411 Mbps PCM</b> *Depends on source resolution
Interspeaker connection	Wireless: all sources resampled to 48 kHz/24 bit PCM Wired: all sources resampled to 96 kHz/24 bit PCM
Supported format (network)	MQA, DSD, FLAC, WAV, AIFF, ALAC, AAC, WMA, MP3, M4A, LPCM and Ogg Vorbis

Dimensions  
(H x W x D per speaker) 240 x 155 x 180 mm  
(9.5 x 6.1 x 7.1 in.)

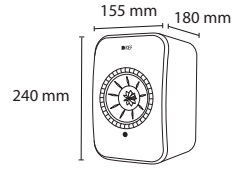

Weight (per set) 7.1 kg (15.6 lbs)  
 Power input 100–240 VAC 50/60 Hz  
 Power consumption 200 W (operating power)  
 < 2.0 W (standby power)

	Primary Speaker	Secondary Speaker
Inputs	HDMI ARC TOSLINK Optical USB Type C Analog 3.5 mm Auxiliary RJ45 Ethernet (network) RJ45 Ethernet (interspeaker)	RJ45 Ethernet (interspeaker)
Output	RCA Subwoofer output	–
Wi-Fi network standard	IEEE 802.11a/b/g/n/ac IPv4, IPv6	–
Wi-Fi network frequency band	Dual-band 2.4 GHz / 5 GHz	–

Metamaterial Absorption Technology is a joint development with Acoustic Metamaterials Group

MQA and the Sound Wave Device are registered trade marks of MQA Limited © 2016

Wireless performance depends on many factors, including network traffic, distance from access point, room materials and construction, interference and other adverse conditions.

For further information and troubleshooting, please visit the KEF website: [KEF.COM](http://KEF.COM)

KEF reserves the right, in line with continuous research and development, to amend or change specifications without prior notice. E. & O.E



The Bluetooth word mark and logos are registered trademarks owned by Bluetooth SIG, Inc.



Amazon Music is a registered trademark of Amazon.com Inc.



Apple and AirPlay are registered trademarks of Apple Inc., registered in the U.S. and other countries.





Deezer is a registered trademark of Access Industries.



Google Play store and Chromecast are registered trademarks of Google LLC.



MQA and the Sound Wave Device are registered trade marks of MQA Limited © 2016



Qobuz is a registered trademark of Xandrie SA.



QQ Music is a registered trademark of Tencent Music Entertainment Group (TME).



ROON is a registered trademark of Roon Labs LLC or Roon Labs's licensors.



Spotify is a registered trademark of Spotify AB.



TIDAL is a registered trademark of Aspiro AB.

## 18.2 Speaker Connection Test

The speaker connection test in KEF Connect shows you how much network bandwidth is available to your KEF wireless speaker system. It considers every stage of your network by downloading a file from a random server to the speakers – from the bandwidth provided by your internet service provider (ISP) and server traffic, all the way to the speed of the connection between your router and speakers. The other value shown is the 'ping.' This is a signal we use to check if the server is reachable and tells us how long it takes.

### What speeds are needed for different services?

Different music streaming services have different recommendations depending on the audio file sizes involved:

Service	Minimum Recommended Bandwidth
Tidal (Master tier)	2 Mbps
Amazon Music (Ultra HD)	5-10 Mbps
Amazon Music (HD)	1.5 – 2 Mbps
Deezer	5 Mbps
Qobuz	10 Mbps

Note that these are minimum dedicated speeds recommended by the services themselves.

What this means is that your total network bandwidth must exceed the total bandwidth requirements of all devices on the network. If your active network devices

need more bandwidth than what is available, then you may experience slower speeds, reduced performance and dropouts. This is not as much of a problem for web browsing or file downloads (except for being slower) but is especially problematic for music streaming.

### My test score is a lot lower than what I pay my ISP for. Why?

The bandwidth provided by your ISP (Internet Service Provider) is advertised as ‘up to’ as this is the maximum bandwidth you can expect coming into your network. This can be affected by many things such as the quality of the provider’s cabling, ‘Fair Use’ clauses in the agreement and the amount of people accessing the same server.

But even if you get the maximum advertised bandwidth from your ISP, the home network may be creating a bottleneck. Major factors include interference, obstructions and distance between the router and device. Even time of day can have an effect – if more people are using the internet in your area, that can reduce bandwidth. However, there are some simple things to try that can really help improve your test score.

### Why is the score lower than other tests?

Internet connectivity tests are often optimised to give you a theoretical ‘best scenario’ speed and can be a good indicator for what your ISP is providing but will not tell you specifically what bandwidth your KEF speaker system will be able to take advantage of. The KEF Connect speaker connection test more closely represents what happens when using the speaker system normally:

	KEF Connect	Other
Server used for test	Random (Real world situation)	Nearest possible (Optimised, unrealistic)
Number of Connections opened	One (Works as your KEF speaker system would)	As many as possible (Artificially maximises your network throughput)
File(s) downloaded to...	KEF speaker system (Factors in the quality of the system’s connection to the network)	Phone/Computer (May be in a higher/lower quality network area)

### Improving your network experience

There are a few ways in which bandwidth may be improved. Some are very simple and require no knowledge of computers and routers, whilst others are slightly more advanced, involving changing router settings. Always refer to the router manual, and if in doubt, do consult a professional.

First, it is important to determine how your speaker system is connected to your router – wired by Ethernet cable or connected wirelessly.

## If connected by Ethernet cable:

1. Ensure the router firmware is updated.

This is a basic step for any electronic device, as updated firmware may address known bugs.

2. Reboot the router.

Routers are basically computers and are affected by the same problems. Bugs and temporary errors can cause too much memory being used, or the router can be overheating (one reason to not place it in an enclosed space!). In addition, there may be IP address conflicts. Rebooting the router will often help with these issues. In fact, rebooting the router should be done on a regular basis, or whenever network performance is slower. Some routers even have the option to schedule reboots, so you can 'set and forget.'

3. Check the cable for damage/excessive kinks.

Cable length for home networks is rarely an issue (Cat 6 Ethernet can carry 10 Gbps over 37 m/121 ft for example), but if they are bent too far or damaged, performance can be compromised.

4. Reconsider using 'network homeplugs' if you are doing so.

These devices use your mains wiring as an extension of an Ethernet cable. Whilst a convenient solution, they don't always work as expected, as they are highly dependent on the quality and topology of your mains wiring.

## If connected wirelessly:

### Basic

Steps to take if using a wireless connection. These steps do not involve changing the settings of your router:

1. Ensure the router firmware is updated.

This is a basic step for any electronic device, as updated firmware may address known bugs.

2. Reboot the router.

Routers are basically computers and are affected by the same problems. Bugs and temporary errors can cause too much memory being used, or the router can be overheating (one reason to not place it in an enclosed space!). In addition, there may be IP address conflicts. Rebooting the router will help with all these issues and should be performed periodically (every 2 months or whenever the network seems considerably slower than normal).

3. Try connecting with an Ethernet cable to your router.

This may not always be possible, but if it is, going cabled will eliminate the issues described below.

#### 4. Reduce distance between the router and device.

Wi-Fi signal is like sound – the further you move away from it, the ‘quieter’ it is – the less bandwidth is available.

#### 5. Move transmitting devices away from the speakers.

Transmitting devices such as cordless phones, Bluetooth devices, baby monitors and even routers can cause interference if too close. You can troubleshoot by turning off nearby transmitters and seeing if this improves the network performance of the KEF speaker system. If it does, try increasing the distance between the devices.

#### 6. Reduce obstructions between the router and device.

And just like with distance, obstructions can block signal, reducing bandwidth. Metal is the worst offender (reinforced concrete, back of mirrors), followed by concrete, plaster and brick. This is one of the big reasons to get the router out of the basement, or the cupboard under the stairs.

#### 7. If your router is in a different room, try switching to the 2.4 GHz band.

Most modern routers are dual band. This means they transmit on both the 2.4 GHz band and the 5 GHz bands. The 5 GHz band has higher potential bandwidth, but far shorter range and is highly affected by obstructions. It may be possible that, whilst the 2.4 GHz band has a lower total bandwidth, in practice it is a better choice when the router and speakers are not in the same room.

#### 8. If you have a lot of neighbours, or a lot of network devices, try the 5 GHz band.

If you have a lot of devices on the 2.4 GHz band, then there may be little available bandwidth left. If your KEF speaker system is close to the router and has little to no obstructions, try connecting it to the 5 GHz band for more bandwidth. If there are obstructions, try migrating network devices that are closer to the router to the 5 GHz band instead, freeing up bandwidth on the 2.4 GHz band. This is also useful if you have a lot of neighbours close by, as their networks may be interfering with yours.

### Advanced

These steps are a little bit more advanced and may involve changing router settings. Always follow your router manual, or consult a professional:

#### 1. Change your band channels.

Both 2.4 GHz and 5 GHz bands are comprised of multiple channels. Other nearby networks on the same channels will compete for bandwidth, so use a ‘network analyser’ app to determine which channels are less congested and adjust in your router settings. This issue is more common with 2.4 GHz due to the longer range and lower bandwidth, increasing the chance and severity of interference. 2.4 GHz channels also overlap – good options are generally 1, 6 and 11. Channel selection is

often set to 'auto,' but some routers are better at swapping channels than others, so it can be useful to set the channel manually.

A note on 5 GHz channels – not all channels are open for public use in various countries. Check with your local authority as to which channels are unrestricted (most routers will automatically turn these off if the router is correctly configured for the country).

## 2. Disable band steering.

Some routers offer a feature called 'band steering.' The idea is that the router will automatically place a device onto the 5 GHz or 2.4 GHz depending on which is best for that device at the time. Again, some routers are better at this than others, with some preferring to stick with a weaker 5 GHz network rather than switching to a stringer 2.4 GHz network.

## 3. Disable combined SSID and operate separate 2.4 GHz and 5GHz channels.

Some devices allow you to set the same name/password for both 2.4 GHz and 5 GHz channels of your router. This can be very useful, but some devices do seem to want to default connecting to 2.4 GHz when 5 GHz would be better, and vice versa. Maintaining separate 2.4 GHz and 5GHz networks will help with optimising bandwidth by allowing you to manage what devices are placed on which network.

## Mesh networks and Wi-Fi extenders

Mesh networks and Wi-Fi extenders can be very useful tools to improve network coverage in the home. However, they must be planned and installed correctly for the best performance. The information below is a summary of mesh network considerations - for more technical details or assistance in setting up a mesh network, please refer to the manufacturer or an expert network device retailer.

The most important thing to remember is that they are effectively repeaters – they receive data from the router, and then pass it on to the next node or device. This adds latency (delay), but they are also limited by available bandwidth – the connection between a router and a node is subject to the same issues outlined earlier – distance, obstructions and interference.

So, when designing a mesh network or planning where to place Wi-Fi extenders, budget for more nodes than you think you need, and place them closer together. This will help maximise the potential bandwidth.

It is also worth noting that different router manufacturers handle mesh technology differently, and there may be compatibility issues with networked devices. If this is the case when using a KEF wireless speaker system, please send a support request, including the speaker logs, through the KEF Connect app.



## 18.3 Explanation of symbols

### 18.3.1 Warning Symbols



The lightning flash with arrowhead symbol, within an equilateral triangle, is intended to alert the user to the presence of uninsulated “dangerous voltage” within the products enclosure that may be of a sufficient magnitude to constitute a risk of electrical shock to persons.



The exclamation mark within an equilateral triangle is intended to alert the user to the presence of important operating and maintenance (servicing) instructions in the literature accompanying the appliance.

### 18.3.2 Regional Symbols

#### Europe and North America



This marking indicates that this product should not be disposed with other household wastes throughout the EU. To prevent possible harm to the environment or human health from uncontrolled waste disposal, recycle it responsibly to promote the sustainable reuse of material resources.

To dispose of your used device, please use the proper collection system or contact the retailer where the product was purchased, they may be able to take the product for environmentally safe recycling.



Products marked with this symbol meet all applicable Community regulations for the European Economic Area.



This UL symbol means UL found that representative product samples met UL's requirements (Canada, United States).



This UL Energy Certification Mark symbol means UL has certified that the product meets the requirements for energy efficiency and is consistent with technical and legal requirements of the United States and Canadian markets.



This FCC mark certifies that the electromagnetic interference from the device is under the limits approved by the Federal Communications Commission in the US.

---

## Asia-Pacific

---



The Regulatory Compliance Mark (Australia, New Zealand) indicates that the product complies with the relevant guidelines of the ACMA as well as corresponding government requirements for the safety of electrical devices.

---



The symbol indicates that the product meets the specified safety requirements of Singapore Consumer Protection Registration Scheme.

---



The Japan PSE Mark Certification indicates that the product meets the technical requirements of the Electrical Appliance and Material Safety Law (DENAN).

---



These marks indicate compliance with technical and design requirements for telecommunication terminal equipment in Japan.

---



The Korean Certification mark indicates that the product complies with Korea's product safety requirements for electrical and electronic equipment.

---



The China Compulsory Certificate mark indicates that the product meets the safety requirements of the Chinese national standards (Guobiao).

---



The product is only suitable for use in areas under 2,000 m above sea level (China).

---



RoHS (China): This product contains certain hazardous substances and can be used safely during its environmental friendly use period (10 years). The product should enter into the recycling system after its environmental friendly use period.

---



RoHS (Taiwan): This symbol means that the product does not exceed the specified concentration limits for specific hazardous substances.

---



The product obtained the certification from the Taiwan National Communications Commission (NCC) for low-power radio frequency appliances.

---



This MCMC certification mark indicates that a communications device is certified for compliance to standards according to the Communications and Multimedia (Technical Standards) Regulations 2000 in Malaysia.

---

## 18.4 IR Command Codes

LSX II works with universal programmable remote control provided that the remote control manufacturers have implemented KEF IR command codes in their remote controls.

The following table lists the command codes required.

<b>Code Format:</b>	NEC
<b>Factory Code:</b>	0x01

	Functions	Function codes
1	Power on/off toggle	0x40
2	Mute/un-mute toggle	0x20
3	Play/Pause	0x18
4	Forward	0x52
5	Next source	0x58
6	Volume up	0x60
7	Volume down	0xA0
8	Backward	0xD2
9	Power ON	0x38
10	Power OFF	0x3A
11	Mute	0x48
12	Un-mute	0x4A
13	Source: Wi-Fi	0x30
14	Source: Bluetooth	0x2A
15	Bluetooth pairing	0x98
16	Source: AUX	0x02
17	Source: Optical	0x0A
18	Preset volume (30 %)	0x78
19	Source: HDMI	0x88 / 0x8A
20	Source: USB	0x1A
21	Previous source	0xD0

For more support, please visit [kef.com](https://www.kef.com)