

Tefal®

EN



Easy Fry

www.tefal.co.uk

www.tefal.com.au

SAFETY INSTRUCTIONS

IMPORTANT SAFEGUARDS

- This appliance is intended for domestic use only. It is not intended to be used in the following applications, and the guarantee will not apply for:
 - staff kitchen areas in shops, offices and other working environments;
 - farm houses;
 - by clients in hotels, motels and other residential type environments;
 - bed and breakfast type environments.
- This appliance is not intended to be operated by means of an external timer or a separate remote control system.
- If the power supply cord is damaged, it must be replaced by the manufacturer, an authorised service centre or a similarly qualified persons in order to avoid any danger.
- This appliance is not intended for use by persons (including children) with reduced physical, sensory or mental capabilities, or lack of experience and knowledge, unless they have been given supervision or instruction concerning use of the appliance by a person responsible for their safety.
- Children should be supervised to ensure that they do not play with the appliance.
- This appliance can be used by children aged from 8 years and above and persons with reduced physical, sensory or mental capabilities or lack of experience and knowledge if they have been given supervision or instruction concerning use of the appliance in a safe way and understand the hazards involved. Children shall not play with the appliance. Cleaning and user maintenance shall not be made by children unless they are older than 8 and supervised. Keep the appliance and its cord out of reach of children less than 8 years.
-  The temperature of accessible surfaces may be high when the appliance is operating. Do not touch the hot surfaces of the appliance.
- Clean removable parts with a non abrasive sponge and washing up liquid or in a dishwasher (depending on model).
- Clean the inside and the outside of the appliance with a damp sponge or cloth. Please refer to the «Cleaning» section of the instructions for use.
- The appliance can be used up to an altitude of 2000 m.

Do

- Read and follow the instructions for use. Keep them safe.
- Remove all packaging materials and any promotional labels or stickers from your appliance before use. Be sure to also remove any materials from underneath the removable bowl (depending on model).
- Check that the voltage of your mains network corresponds to the voltage given on the rating plate on the appliance (alternative current).
- Given the diverse standards in effect, if the appliance is used in a country

other than that in which it is purchased, have it checked by an approved Service Centre.

- For models with detachable power cords, only use the original power cord.
- Always plug the appliance into an earthed socket.
- Use the appliance on a flat, stable, heat-resistant work surface away from water splashes.
- Place the appliance at minimum 20 cm from a wall.
- Always unplug your appliance: after use, to move it, or to clean it.
- In the event of fire, unplug the appliance and smother the flames using a damp tea towel.
- To avoid damaging your appliance, please ensure that you follow recipes in the instructions and at www.tefal.co.uk or www.tefal.com.au; make sure that you use the right amount of ingredients.

Do not

- Do not use the appliance if it or the power cord is damaged or if it has fallen and has visible damage or appears to be working abnormally. If this occurs, the appliance must be sent to an Approved Service Centre.
- Do not use an extension lead. If you nevertheless decide to do so, under your own responsibility, use an extension lead that is in good condition and compliant with the power of the appliance.
- Do not let the power cord dangle.
- Do not unplug the appliance by pulling on the power cord.
- Never move the appliance when it still contains hot food.
- Never operate your appliance when empty.
- Do not switch on the appliance near to flammable materials (blinds, curtains...). or close to an external heat source (gas stove, hot plate etc.).
- Do not store any flammable products close to or underneath the furniture unit where the appliance is located.
- Never take the appliance apart yourself
- Do not immerse the product in water.
- Do not use any powerful cleaning products (notably soda based strippers), nor brillo pads, nor scourers.
- Do not store your appliance outside. Store it in a dry and well ventilated area.

Advice/information

- When using the product for the first time, it may release a non-toxic odour. This will not affect use and will disappear rapidly.
- For your safety, this appliance conforms with applicable standards and regulations (Low Voltage Directive, Electromagnetic compatibility, Environment, Materials in contact with food...).
- This appliance is designed for domestic use only and not outdoor. In case of

professional use, inappropriate use or failure to comply with the instructions, the manufacturer accepts no responsibility and the guarantee does not apply.

- For your safety, only use the accessories and spare parts designed for your appliance.

Environnement

- Before discarding your appliance, the battery from the timer has to be removed and disposed at a local civic waste collection centre or an approved service centre.
(depending on model).



Environment protection first!

① Your appliance contains valuable materials which can be recovered or recycled.

➡ Leave it at a local civic waste collection point.

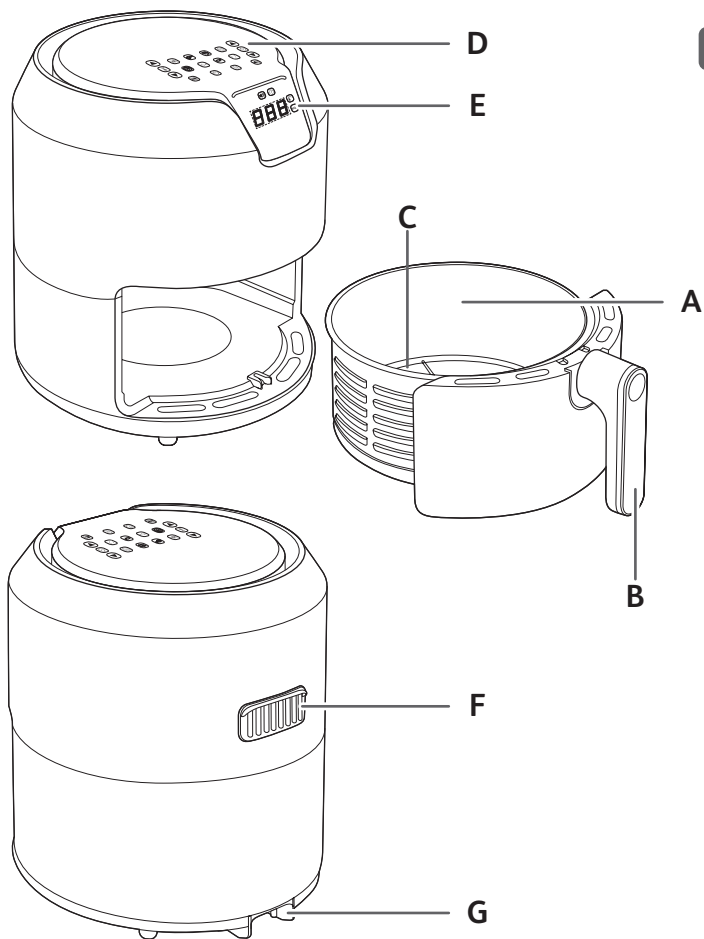

DESCRIPTION

- A. Bowl
- B. Bowl handle
- C. Removable grid
- D. Digital touchscreen panel
- E. Time/temperature display
- F. Air outlet
- G. Power cord cover

AUTOMATIC COOKING MODES

- 1. Fries
- 2. Cutlet
- 3. Shrimp
- 4. Cake
- 5. Pizza
- 6. Fish
- 7. Grill
- 8. Roast

BEFORE FIRST USE

1. Remove all packaging material.
2. Remove any stickers or labels from the appliance.
3. Thoroughly clean the bowl and the removable grid with hot water, some washing-up liquid and a non-abrasive sponge.

Note: You can also clean these parts in the dishwasher.



4. Wipe the inside and outside of the appliance with a damp cloth. Easy Fry works by producing hot air. Do not fill the bowl (A) with oil or frying fat.

PREPARING FOR USE

1. Place the appliance on a flat, stable, heat-resistant work surface away from water splashes.
2. **Do not fill the bowl with oil or any other liquid.**
Do not put anything on top of the appliance. This disrupts the airflow and affects the hot air frying result.

USING THE APPLIANCE

Easy Fry can cook a large range of recipes. Cooking times for the main foods are given in the section 'Cooking Guide'. Online recipes at www.tefal.co.uk help you get to know the appliance.

1. Connect the power supply cord to an electrical socket.
2. Start the preheating phase if you wish. To do this, press the Start button  that begins flashing as soon as the appliance is plugged in. The temperature displayed on the first use is 180°C.
 - Adjust to the desired temperature with the  and  buttons on the digital screen.
 - Press the Start button again to start preheating.
 - The appliance will beep when the temperature has been reached.
 - The preheating phase is now completed.

- Place the food in the bowl.







Note: Never fill the bowl beyond the MAX level mark or exceed the maximum amount indicated in the table (see into section 'Cooking Guide'), as this could affect the quality of the end result.

- Slide the bowl back into the Easy Fry.





Caution: Do not touch the bowl during use and for some time after use, as it gets very hot. Only hold the bowl by the handle.

- To begin cooking, you can select between the automatic cooking mode or choose the manual settings.

a. If choosing manual settings:

- Adjust the temperature  with the  and  buttons on the digital screen. The thermostat varies from 80-200°C.
- Then set the desired cooking time by pressing the  button and adjusting the time with the  and  buttons. The timer can be set for between 0 and 60 minutes.
- Press the Start button to begin cooking with the selected temperature and time settings. Cooking starts. The selected temperature and remaining cooking time will alternate on the screen display.

b. If choosing automatic cooking mode:

- Press  button to display the cooking mode.
 - Then press  button on the screen to select the desired cooking mode (these modes are described in detail in the "Cooking guide" section).
 - Confirm the cooking mode by pressing the Start button. This will launch the cooking process.
 - Cooking starts. The selected temperature and remaining cooking time will alternate on the on-screen display.
- Excess oil from the food is collected in the bottom of the bowl.
 - Some foods require shaking halfway through the cooking time (see section 'Cooking Guide'). You can use the  to set an alert every 5, 10 or 15 minutes. To shake the food, pull the bowl out of the appliance by the handle and shake it. Then slide the bowl back into the Easy Fry and press the Start button  again to restart cooking.
 - Once the cooking time has elapsed, the appliance will make a sound and switch off. Pull the bowl out of the appliance and place it on a heat-resistant surface.
 - Check if the food is ready.

If the food is not ready yet, simply slide the bowl back into the appliance and set the timer for a few extra minutes.

- When the food is cooked, take out the bowl. To remove food, use a pair of tongs to lift the food out of the bowl.

Caution: When you turn the bowl, be careful of any excess oil collected at the bottom of the bowl that may leak onto the food and the grid which may fall out.

After hot air frying, the bowl, the grid and the food are very hot. Depending on the type of food cooked in the Easy Fry, be careful as steam may escape from the bowl.















- When a batch of food is ready, the Easy Fry is instantly ready for preparing another batch of food.

Note: after 15 minutes of inactivity, the appliance will switch to Sleep mode. Press the button to turn it back on again.

COOKING GUIDE

The table below helps you to select the basic settings for the food you want to prepare.

Note: The cooking times below are only a guide and may vary according to the variety and batch of potatoes used. For other foods the size, shape and brand may affect results. Therefore, you may need to adjust the cooking time slightly.

	Min-max Amount (g)	Approx Time (min)	Temperature (°C)	Cooking mode	Shake*	Extra information
Potatoes & fries						
Frozen chips (10 mm x 10 mm standard thickness)	300-700 g	15-20 min	200°C		Yes	
Homemade French Fries (8 x 8 mm)	300 - 800 g**	22-32 min	180°C		Yes	Add ½ tbsp of oil
Frozen potato wedges	300 - 800 g	22-27 min	180°C		Yes	
Meat & Poultry						
Frozen steak	100-400 g	9-17 min	180°C			
Frozen meat-balls	400 g	8-12 min	180°C			
Chicken breast fillets (boneless)	100-500 g	12-19 min	180°C			
Chicken (whole)	1200 g	60 min	180°C			
Fish & sea food						
Salmon fillet	350 g	15-17 min	140°C			
Shrimps	12 pieces	4 min	170°C			
Snacks						
Frozen chicken nuggets	100-600 g	7-12 min	200°C			
Frozen chicken wings	300 g	16-20 min	200°C			
Frozen cheese sticks	125 g (5 pieces)	8 min	180°C			
Frozen onion rings	200 g (10 pieces)	8-10 min	200°C		Yes	
Mini-pizzas	5 pieces	7 min	190°C			

	Min-max Amount (g)	Approx Time (min)	Temperature (°C)	Cooking mode	Shake*	Extra information
Baking						
Muffins	4 x 100 g	18-22 min	180°C			Use a baking tin/oven dish****

* Shake halfway through cooking.

** Weight of unpeeled potatoes

****place the cake tin/oven dish in the bowl.

IMPORTANT: To avoid damaging your appliance, never exceed the maximum quantities of ingredients and liquids indicated in the instruction manual and in the recipes.

When you use mixtures that rise (such as with cake, quiche or muffins) the oven dish should not be filled more than halfway.

Visit www.tefal.co.uk or www.tefal.com.au for online recipes.

TIPS

- Smaller foods usually require a slightly shorter cooking time than larger size foods.
- A larger amount of food only requires a slightly longer cooking time, a smaller amount of food only requires a slightly shorter cooking time.
- Shaking smaller size foods halfway through the cooking time improves the end result and can help prevent uneven cooking.
- Add some oil to fresh potatoes for a crispy result. After adding a spoon of oil, fry the potatoes within a few minutes.
- Do not cook extremely greasy foods in the Easy Fry.
- Snacks that can be cooked in an oven can also be cooked in the Easy Fry.
- The optimal recommended quantity for cooking fries is 700 grams.
- Use ready made puff and shortcrust pastry to make filled snacks quickly and easily.
- Place an oven dish in the Easy Fry bowl if you want to bake a cake or quiche or if you want to fry fragile ingredients or filled ingredients. You can use an oven dish in silicon, stainless steel, glass, terracotta.
- You can also use the Easy Fry to reheat food. To reheat food, set the temperature to 160°C for up to 10 minutes.

MAKING HOME-MADE CHIPS

For the best results, we advise to use frozen chips. If you want to make home-made chips, follow the steps below.

1. Choose a variety of potato recommended for making chips. Peel the potatoes and cut them into equal thickness chips.
2. Soak the potato chips in a bowl of cold water for at least 30 minutes, drain them and dry them with a clean, highly absorbent tea towel. Then pat with paper kitchen towel. The chips must be thoroughly dry before cooking.
3. Pour ½ tablespoon of oil (vegetable, sunflower or olive) in a dry bowl, put the chips on top and mix until they are coated with oil.
4. Remove the chips from the bowl with your fingers or a kitchen utensil so that any excess oil

stays behind in the bowl. Place the chips in the bowl.

Note: Do not tip the container of oil coated chips directly into the bowl in one go, otherwise excess oil will end up at the bottom of the bowl.

5. Fry the chips according to the instructions in the section Cooking guide.

CLEANING

Clean the appliance after every use.

The bowl and the grid have a non-stick coating. Do not use metal kitchen utensils or abrasive cleaning materials to clean them, as this may damage the nonstick coating.

1. Remove the mains plug from the wall socket and let the appliance cool down. **Note:** Remove the bowl to let the Easy Fry cool down more quickly.
2. Wipe the outside of the appliance with a damp cloth.
3. Clean the bowl and grid with hot water, some washing-up liquid and a non-abrasive sponge. You can use a degreasing liquid to remove any remaining dirt.

Note: The bowl and grid are dishwasher-safe.

Tip: If dirt is stuck at the bottom of the bowl and the grid, fill them with hot water and some washing-up liquid. Let the bowl and the grid soak for approximately 10 minutes. Then rinse clean and dry.

4. Wipe inside of the appliance with hot water and a damp cloth.
5. Clean the heating element with a dry, cleaning brush to remove any food residues.
6. Do not immerse the appliance in water or any other liquid.

STORAGE

1. Unplug the appliance and let it cool down.
2. Make sure all parts are clean and dry.

GUARANTEE AND SERVICE

If you need service or information or if you have a problem, please visit the Tefal website at www.tefal.co.uk or www.tefal.com.au or contact the Tefal Consumer Care Centre in your country. You can find the phone number in the worldwide guarantee leaflet. If there is no Consumer Care Centre in your country, go to your local Tefal dealer.

TROUBLESHOOTING

If you encounter problems with the appliance, visit www.tefal.co.uk or www.tefal.com.au for a list of frequently asked questions or contact the Consumer Care Centre in your country.

If you have any problems with your appliance or queries call our Customer Relations Team first for expert help and advice: Helpline: 0345 602 1454 - UK (01) 677 4003 - ROI or contact us via our web site: www.tefal.co.uk

FOR AUSTRALIA

Helpline: 1300307824

GROUPE SEB AUSTRALIA

PO Box 7535, Silverwater NSW 2128

www.tefal.com.au

Ref. NC00145129
S.A.S. SEB SELONGEY CEDEX • RC. DIJON B 302 412 226
01/2018