



CATEYE PADRONE+



CYCLOCOMPUTER
CC-PA110W



- This instruction manual is subject to change without notice. See our website for the latest instruction manual (PDF).
- Please visit our website, where a detailed Quick Start manual containing videos can be downloaded.

<http://www.cateye.com/products/detail/CC-PA110W/manual/>



Mounting the
computer

Setting up the
computer

Starting
measurement

Changing settings

Warning / Caution
Product Warranty, etc.

Mounting the computer



1
(1/3)



(2/3)

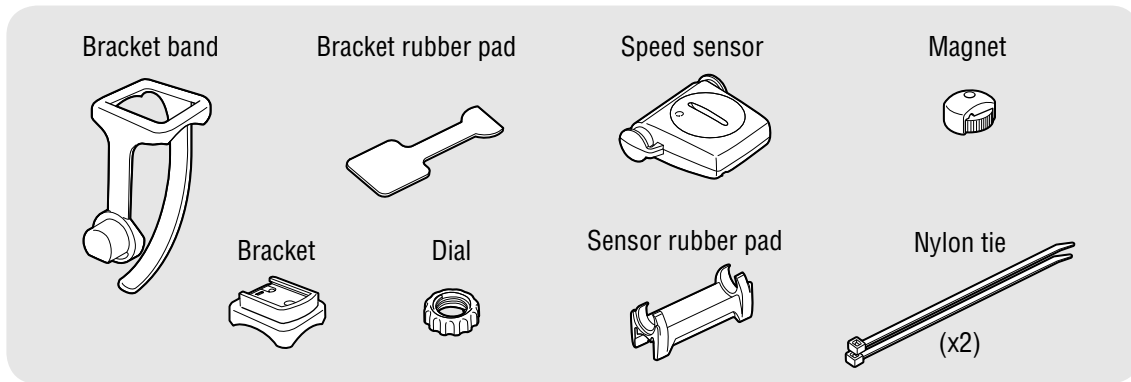

1 Mount the bracket

- When mounting on stem

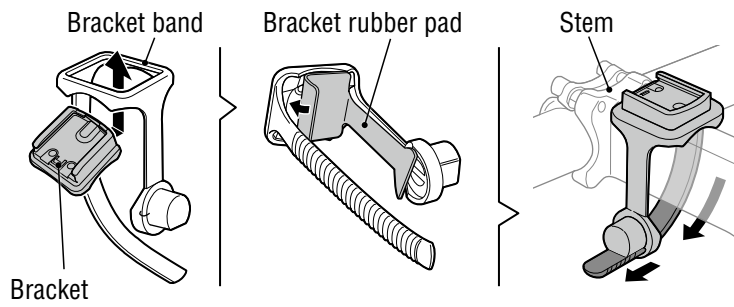
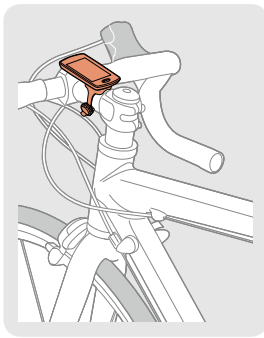

- When mounting on handlebar

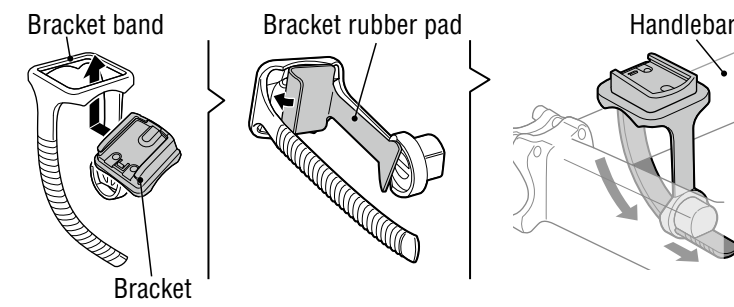
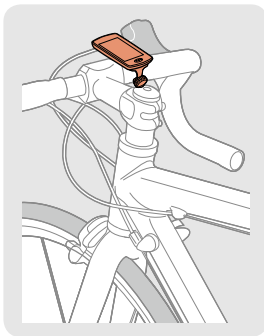

! When mounting the bracket on a handlebar, adjust the angle of the bracket so that the back of the computer faces the speed sensor when the computer is attached.

Correct

Wrong

Cutting band after mounting

CAUTION:
Cut the bracket band so that cut end will not cause injury.

Cut



Mounting the computer

2 Mount the speed sensor

- Mounting on right front fork

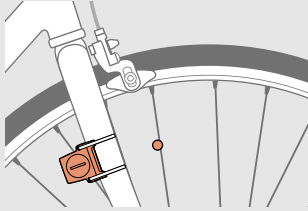

- Mounting on left front fork

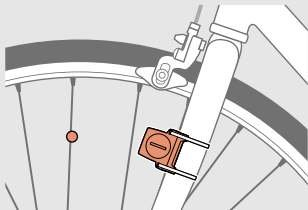

 **Mount the speed sensor in a position where the distance from the computer to the speed sensor is within the signal range.**

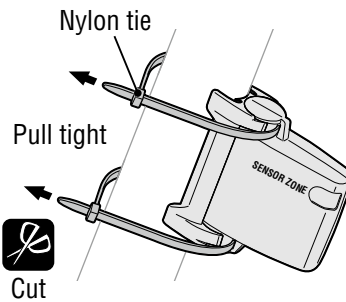
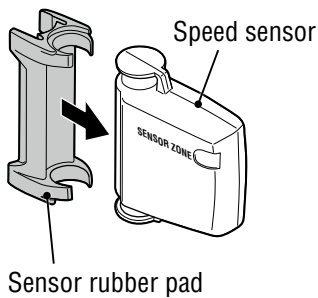
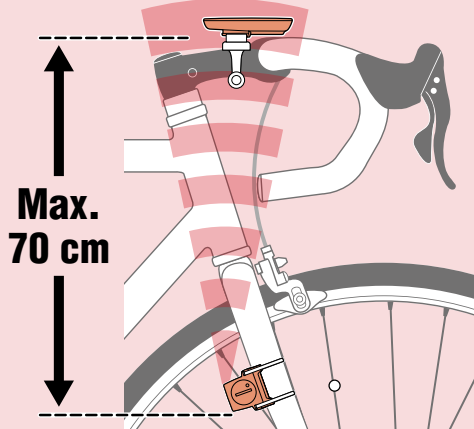

3 Mount the magnet

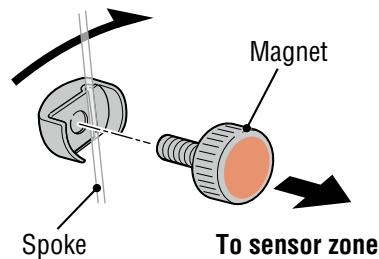
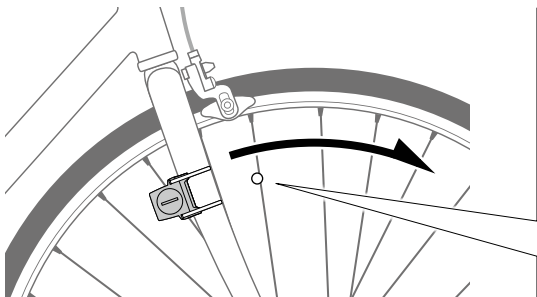



Mounting the computer

4 Adjust the speed sensor and the magnet

The magnet passes through the speed sensor zone.

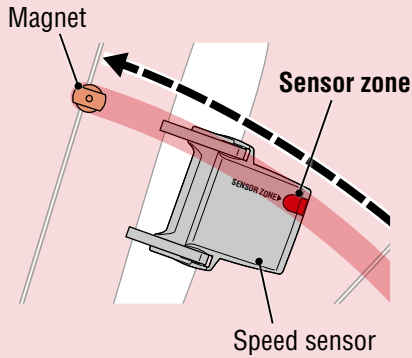

The clearance between the speed sensor and the magnet is within 5 mm (3/16").

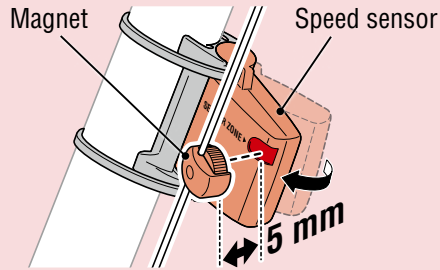

* The magnet may be mounted at any position on spoke as long as attachment conditions are satisfied.

5 Attach/detach computer

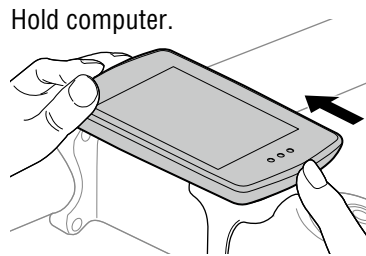
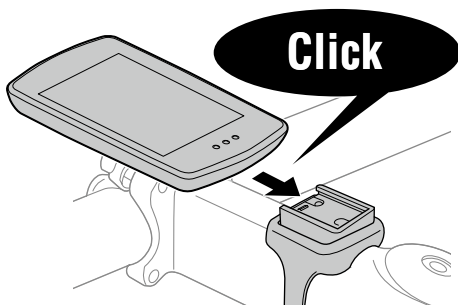

Push out so that front lifts up.

6 Test operation

After attaching the computer, rotate the front wheel gently to check that current speed is displayed on the computer.

If the speed is not displayed, refer to the attachment conditions in steps 1, 2, and 4

again.

Setting up the computer

When using the computer for the first time, configure the initial settings.

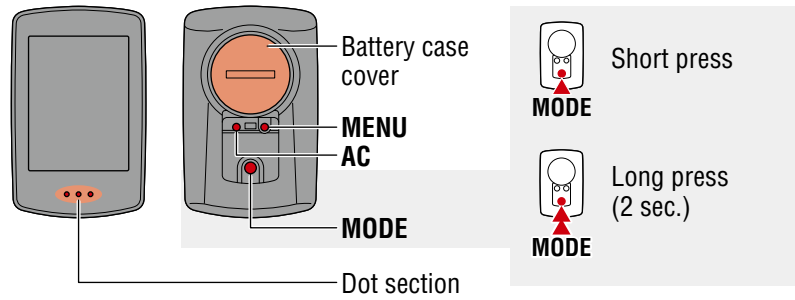

1 Clear all data.

Press the **AC** button on the back of the computer.
 * All data is deleted and the computer is reset to its factory default settings.

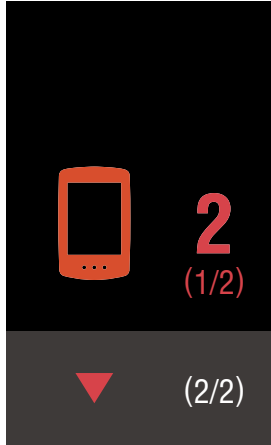
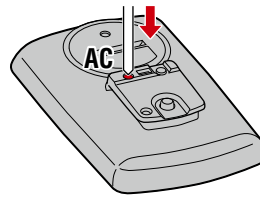

2 Select the measurement unit.

Select “km/h” or “mph”.

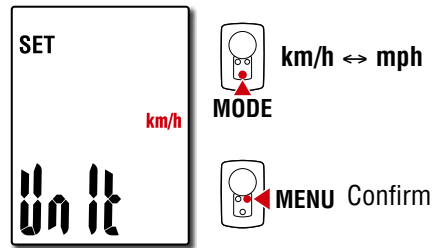

3 Set tire circumference.

Enter the tire circumference of the front wheel in mm.
 * Refer to “Tire circumference”(page 6).

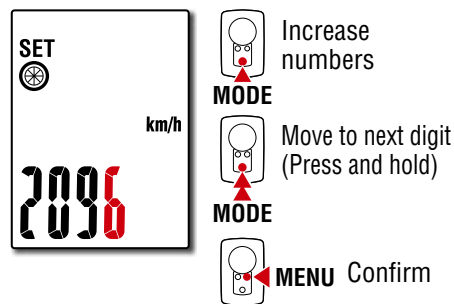

4 Set the clock.

Each time **MODE** is pressed and held, settings switch from time display mode, to hours, to minutes.
 * When 12h mode is selected, make sure to check whether **A** (a.m.) or **P** (p.m.) is displayed before entering the value.

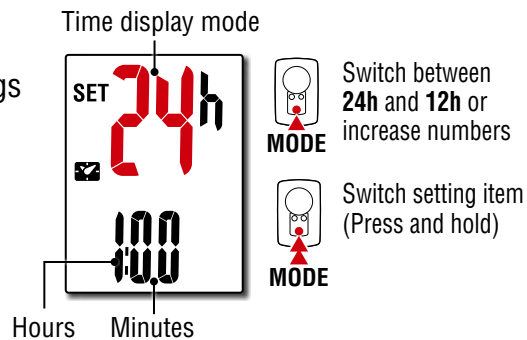

5 Press MENU to complete setup.

Setup is completed and the computer switches to the measurement screen. For instructions on how to start measurement, refer to “Starting measurement”(page 7).

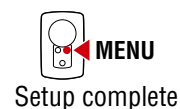

Setting up the computer

Tire circumference

Tire circumference can be determined by either of the following two methods:

- Measure the actual tire circumference (L)
After ensuring that the tire pressure is appropriate, sit on your bike, roll it forward so that the tire makes one full revolution (use the valve or other marking as a reference), and measure the distance traveled on the road.
- Tire size chart
* The tire size or ETRTO code is indicated on the side of the tire.

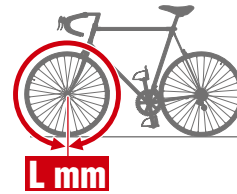

ETRTO	Tire size	L (mm)
47-203	12x1.75	935
54-203	12x1.95	940
40-254	14x1.50	1020
47-254	14x1.75	1055
40-305	16x1.50	1185
47-305	16x1.75	1195
54-305	16x2.00	1245
28-349	16x1-1/8	1290
37-349	16x1-3/8	1300
32-369	17x1-1/4 (369)	1340
40-355	18x1.50	1340
47-355	18x1.75	1350
32-406	20x1.25	1450
35-406	20x1.35	1460
40-406	20x1.50	1490
47-406	20x1.75	1515
50-406	20x1.95	1565
28-451	20x1-1/8	1545
37-451	20x1-3/8	1615
37-501	22x1-3/8	1770
40-501	22x1-1/2	1785
47-507	24x1.75	1890
50-507	24x2.00	1925
54-507	24x2.125	1965
25-520	24x1(520)	1753
	24x3/4 Tubular	1785
28-540	24x1-1/8	1795
32-540	24x1-1/4	1905
25-559	26x1(559)	1913
32-559	26x1.25	1950
37-559	26x1.40	2005
40-559	26x1.50	2010
47-559	26x1.75	2023
50-559	26x1.95	2050
54-559	26x2.10	2068
57-559	26x2.125	2070
58-559	26x2.35	2083

ETRTO	Tire size	L (mm)
75-559	26x3.00	2170
28-590	26x1-1/8	1970
37-590	26x1-3/8	2068
37-584	26x1-1/2	2100
	650C Tubular 26x7/8	1920
20-571	650x20C	1938
23-571	650x23C	1944
25-571	650x25C 26x1(571)	1952
40-590	650x38A	2125
40-584	650x38B	2105
25-630	27x1(630)	2145
28-630	27x1-1/8	2155
32-630	27x1-1/4	2161
37-630	27x1-3/8	2169
40-584	27.5x1.50	2079
50-584	27.5x1.95	2090
54-584	27.5x2.1	2148
57-584	27.5x2.25	2182
18-622	700x18C	2070
19-622	700x19C	2080
20-622	700x20C	2086
23-622	700x23C	2096
25-622	700x25C	2105
28-622	700x28C	2136
30-622	700x30C	2146
32-622	700x32C	2155
	700C Tubular	2130
35-622	700x35C	2168
38-622	700x38C	2180
40-622	700x40C	2200
42-622	700x42C	2224
44-622	700x44C	2235
45-622	700x45C	2242
47-622	700x47C	2268
54-622	29x2.1	2288
56-622	29x2.2	2298
60-622	29x2.3	2326

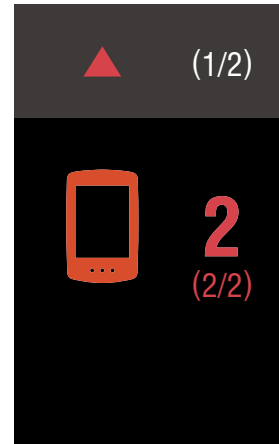

Starting measurement [Measurement screen]

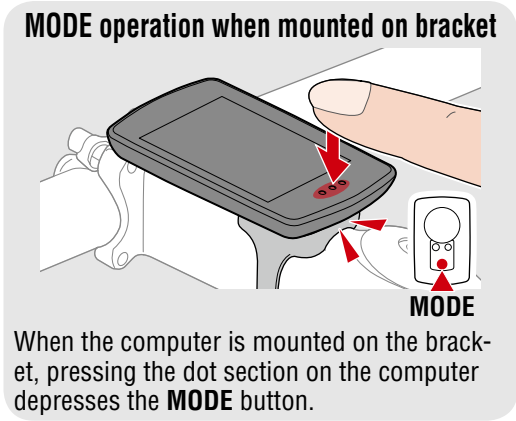
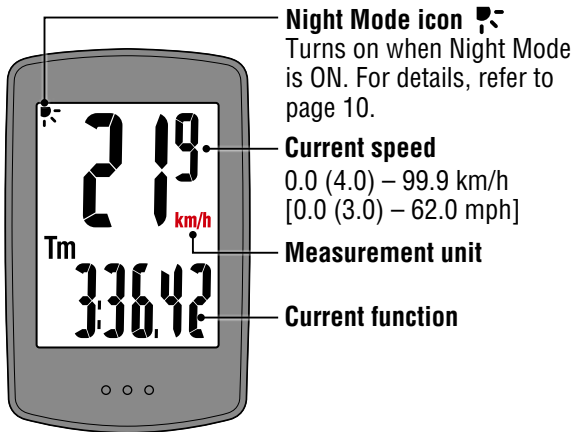

Switching current function

Pressing **MODE** switches the current function displayed at the bottom of the screen.

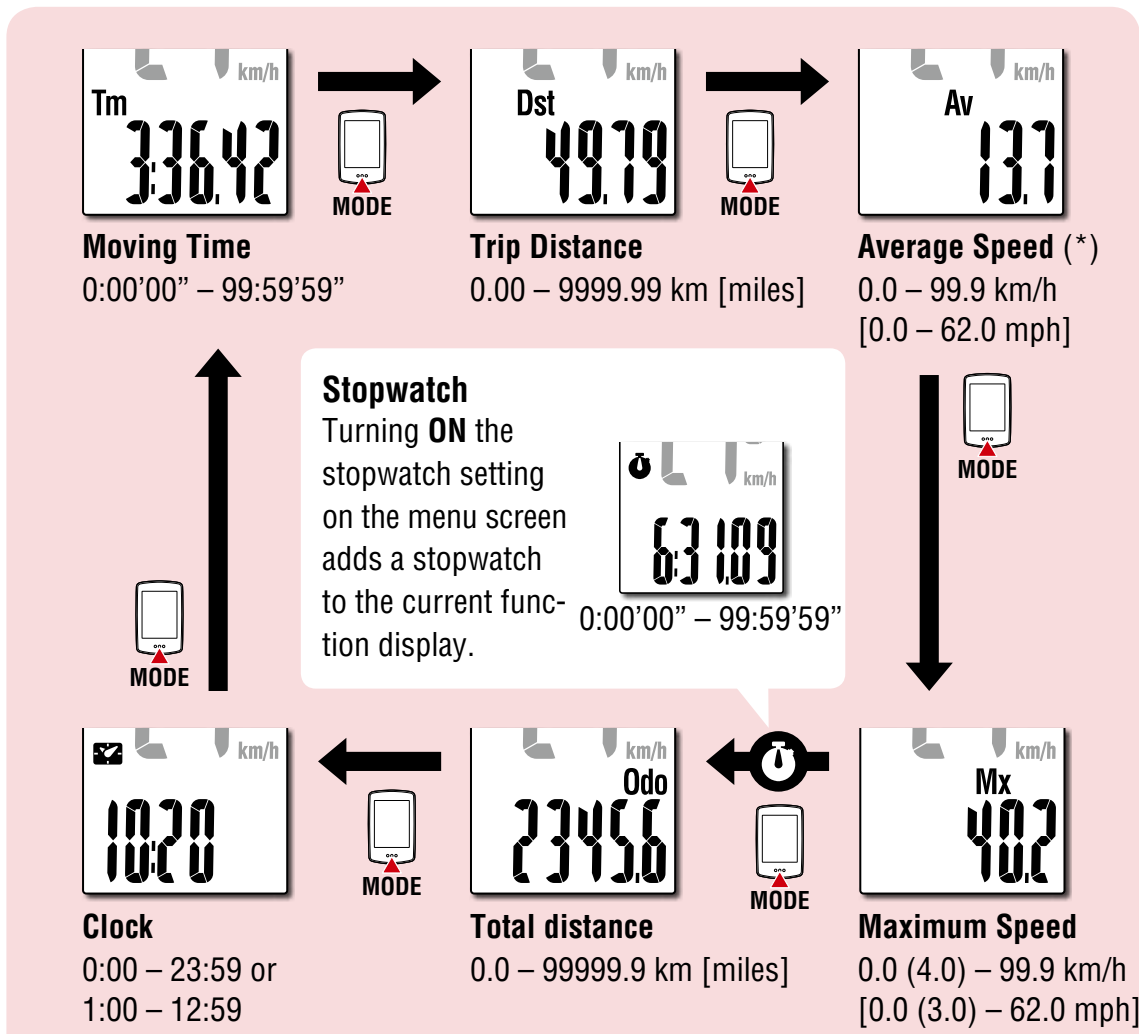

* **Av** displays **.E** instead of the measurement value when **Tm** exceeds approximately 100 hours or **Dst** exceeds 9999.99 km. Reset the computer.

MENU On the measurement screen, press **MENU** to go to the menu screen. Various settings can be changed on the menu screen.

Starting measurement [Measurement screen]

Starting/stopping measurement

Measurement starts automatically when the bicycle moves.

During measurement the measurement unit (km/h or mph) flashes.

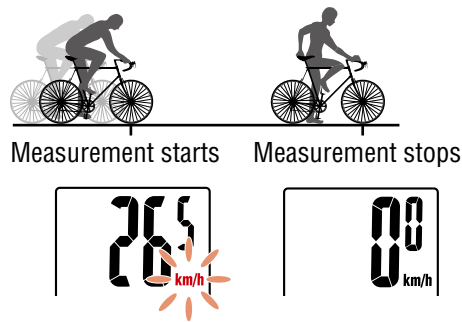

Resetting data

Pressing **MODE** for 2 seconds when on the measurement screen resets all measurement data to 0 (excluding **Odo**).

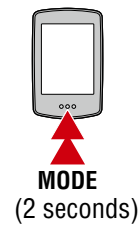

Backlight (Night Mode)

The backlight will come on during the time specified in the Night Mode settings on the menu screen.

The backlight can be set to come on part time (for 5 seconds) or full time (constantly).

* When the remaining battery power is low (when turns on), the backlight will not turn on.



● When Part time is selected:

The backlight will come on when **MODE** is pressed. Pressing **MODE** while the backlight is ON will activate the button's function and extend the lighting time.

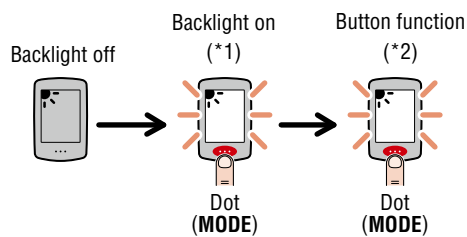

*1: Pressing **MODE** will turn the backlight ON, but the button function is disabled.

*2: Pressing the button again while the backlight is ON will activate the button's function.

● When Full time is selected:

The backlight will come ON while the bicycle is in motion and will turn OFF 30 seconds after the bicycle has stopped.

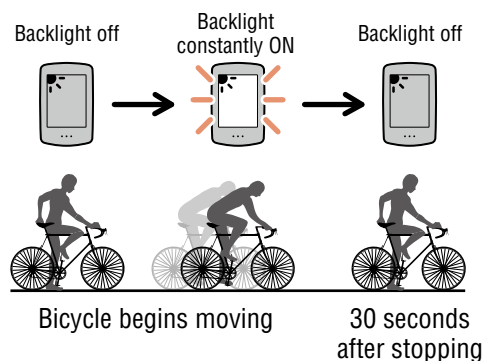

Starting measurement [Measurement screen]

Power-saving function

If the computer does not receive any signal for 10 minutes, the power-saving screen is activated and only the clock is displayed. If **MODE** is pressed or a sensor signal is received while the power-saving screen is activated, the computer returns to the measurement screen.

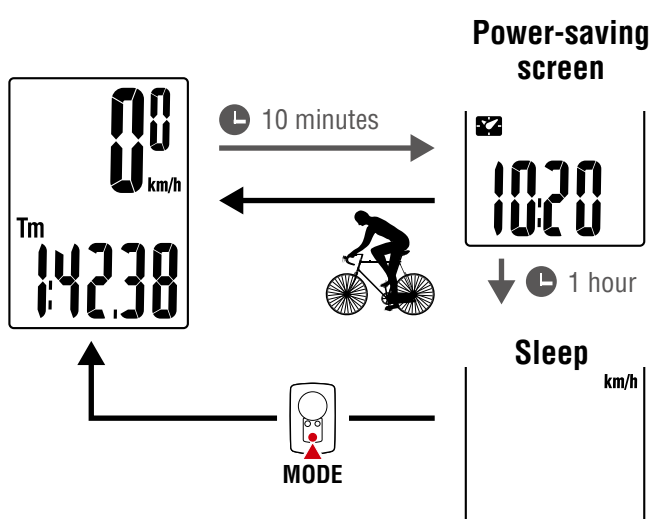

* When the computer is left on the power-saving screen for 1 hour, the display only shows the measurement unit. When the computer is in this state, you can return to the measurement screen by pressing **MODE**.

Using the stopwatch (🕒)

You can display a stopwatch to count time regardless of whether measurement is started or stopped.

To use the stopwatch, set the stopwatch setting on the menu screen to **ON**.

For instructions on how to set the stopwatch, refer to “Stopwatch” (page 13).

Stopwatch operation



Stopwatch

Start/stop	Press MODE for 1 second when the stopwatch is displayed. During counting the 🕒 icon flashes.
Reset	Press MODE for 4 seconds when the stopwatch is displayed.

* Start, stop, and reset operations of the stopwatch are performed separately to measurement, and do not affect other measurements.

* The stopwatch continues counting regardless of the power-saving state. During counting the 🕒 icon flashes on every screen except for the menu screen.



Changing settings [Menu screen]

On the measurement screen, press **MENU** to go to the menu screen. Various settings can be changed on the menu screen.

* After changing settings, always press **MENU** to confirm changes.

* When the menu screen is left on for 1 minute, the computer returns to the measurement screen.

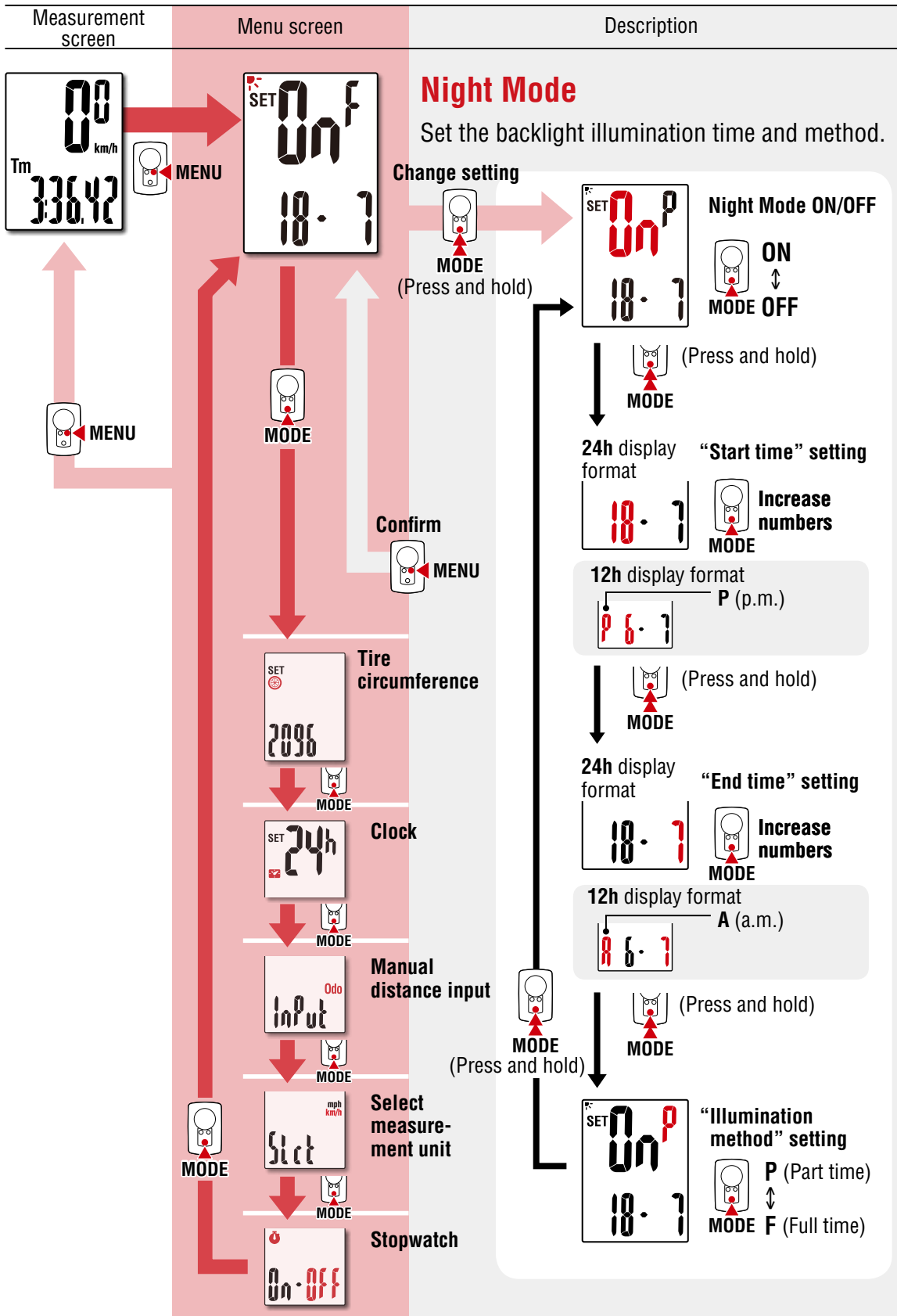

Changing settings [Menu screen]

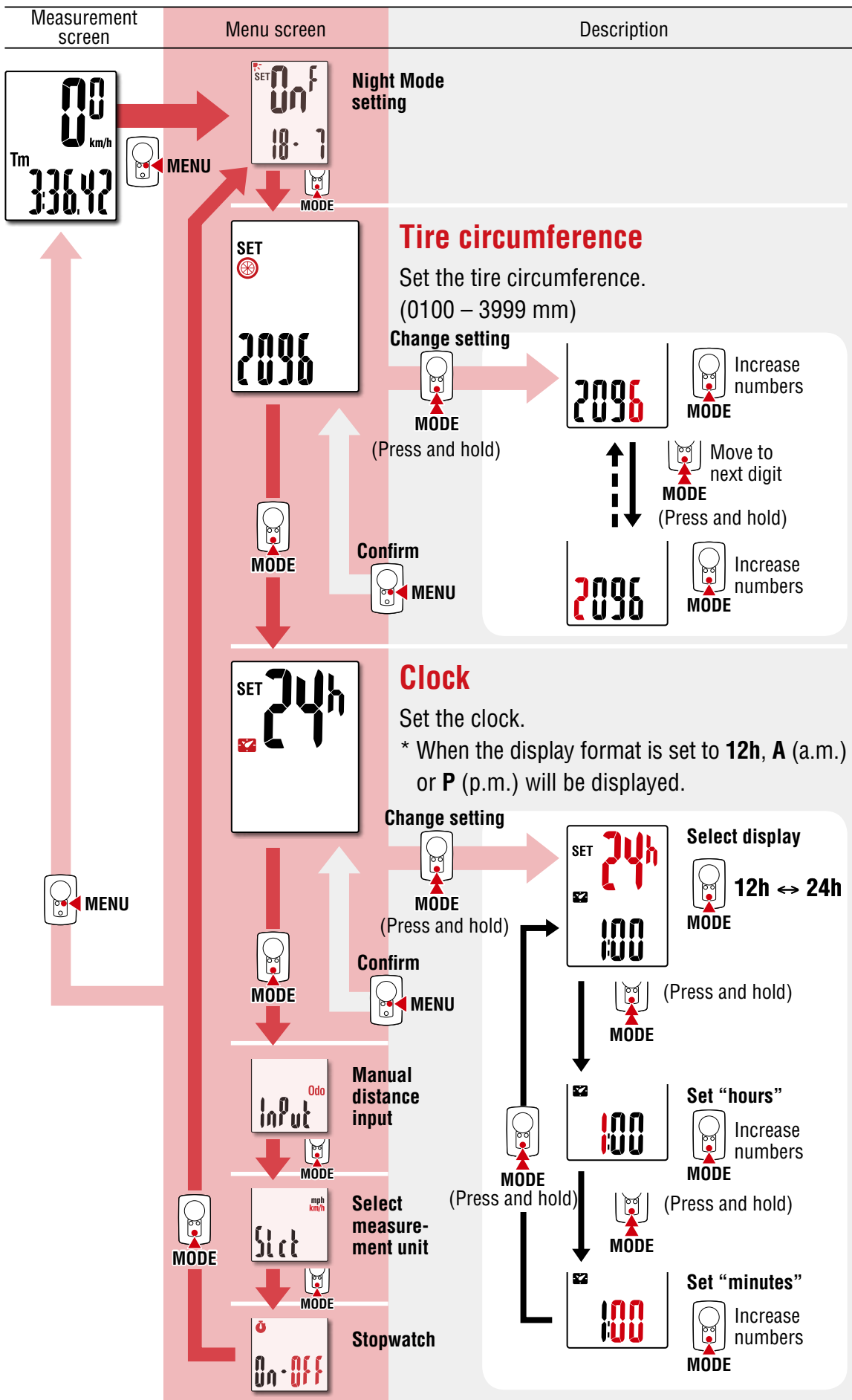

Changing settings [Menu screen]

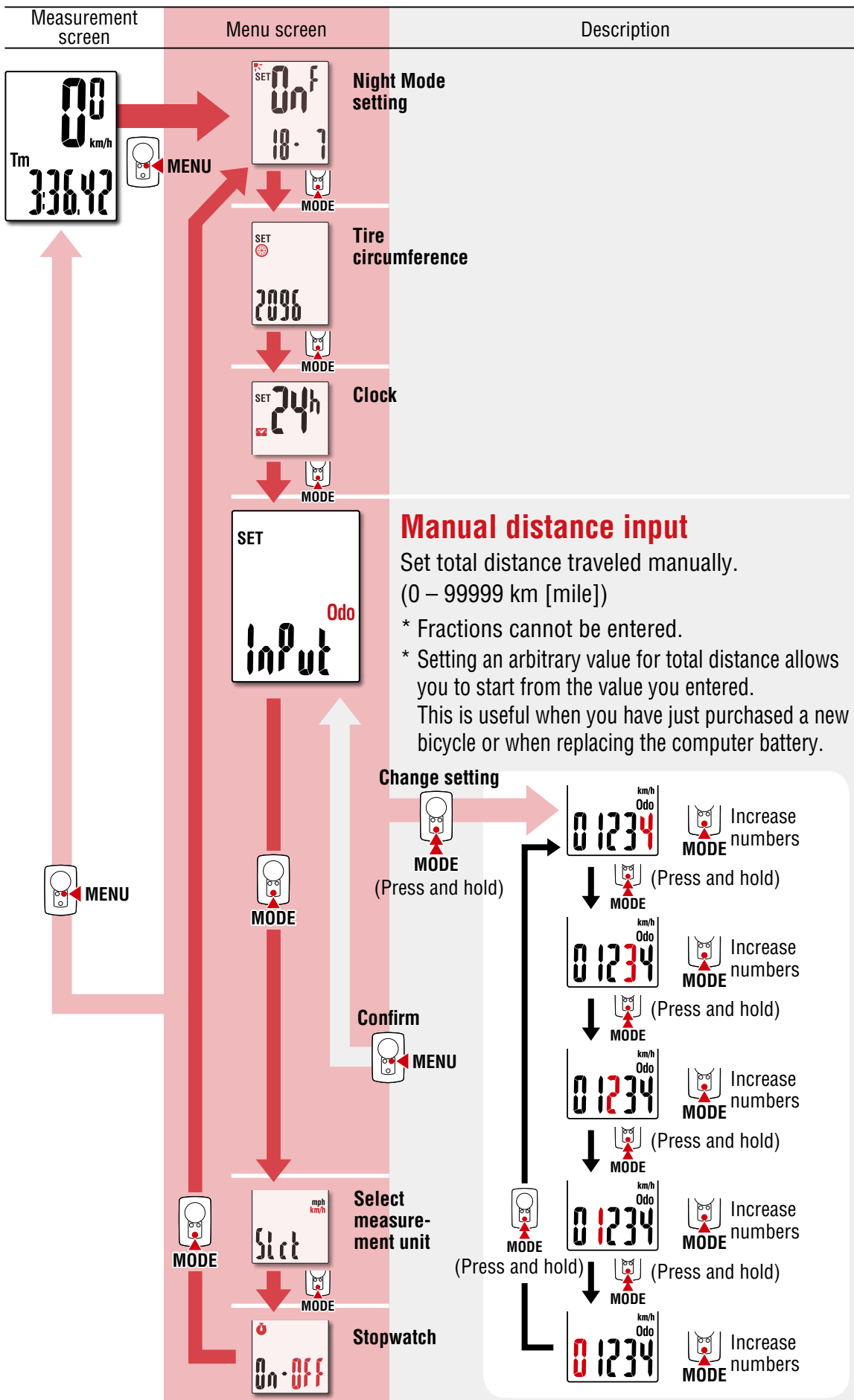

Changing settings [Menu screen]

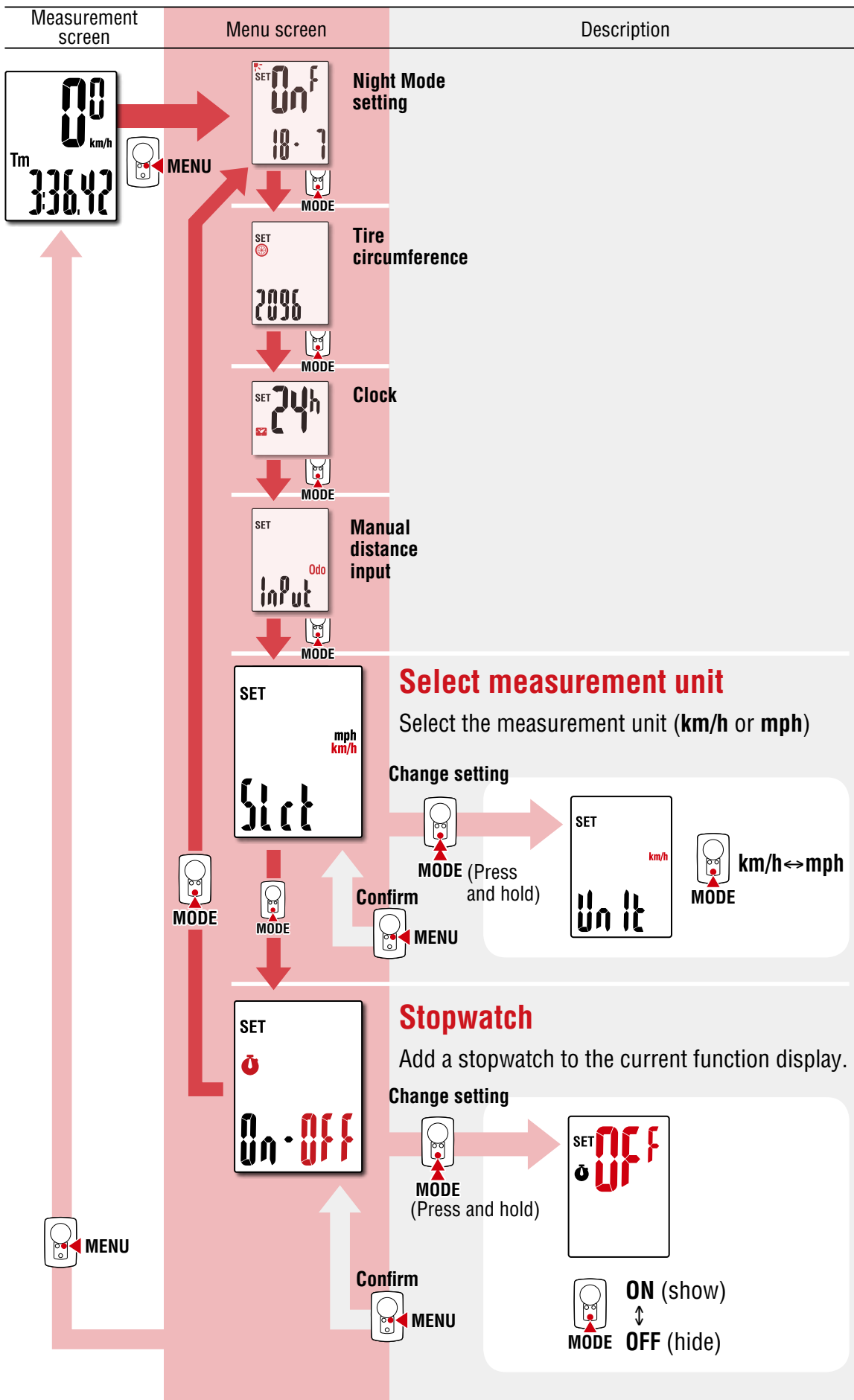

Appendix

Warning / Caution

- Do not concentrate on the computer while riding. Always ride safely.
- Mount the magnet, sensor, and bracket securely, and check them periodically to ensure that they are not loose.
- If a battery is swallowed accidentally, consult a doctor immediately.
- Do not leave the computer in direct sunlight for a long period of time.
- Do not disassemble the computer.
- Do not drop the computer. Doing so may result in malfunction or damage.
- When pressing the **MODE** button with the computer installed on the bracket, press the area around the dot section on the front of the computer. Pressing other areas strongly may result in malfunction or damage.
- Always tighten the bracket band dial by hand. Using a tool or other object to tighten the dial may crush the screw thread.
- When cleaning the computer and accessories, do not use thinners, benzine, or alcohol.
- Risk of explosion if battery is replaced by an incorrect type.
Dispose of used batteries according to local regulations.
- The LCD screen may be distorted when viewed through polarized sunglass lenses.

Wireless Sensor

The speed sensor is designed with a maximum signal range of 70 cm (27”), to reduce the chance of interference. (The signal range is intended to serve as a rough guide only.)

When handling the wireless sensor, note the following:

- Signals cannot be received if the distance between the speed sensor and the computer is too large.
- Signal range may be shortened due to low temperature and flat batteries.
- Signals can be received only when the back of the computer is facing the speed sensor.

Interference may occur, resulting in malfunction, if the computer is:

- Near a TV, PC, radio, or motor, or in a car or train.
- Close to a railroad crossing, railway tracks, TV transmitter station, or radar station.
- Used with other wireless devices or certain battery-powered lights.

Frequency Band: 19 kHz

Radiated Power: -3.8 dBA/m (at 10 m)

Hereby, CATEYE Co., Ltd. declares that the radio equipment type CC-PA110W is in compliance with Directive 2014/53/EU.

The full text of the EU declaration of conformity is available at the following internet address:
cateye.com/doc

This device complies with Part 15 of the FCC Rules. Operation is subject to the following two conditions: (1) This device may not cause harmful interference, and (2) this device must accept any interference received, including interference that may cause undesired operation.

Modifications

The FCC requires the user to be notified that any changes or modifications made to this device that are not expressly approved by CatEye Co., Ltd. May void the user's authority to operate the equipment.

Appendix

Maintenance

If the computer or accessories become dirty, clean with a soft cloth which is moistened with mild soap.

Replacing the battery

● Computer

When  (battery icon) is turned on, replace the battery. Insert a new lithium battery (CR2032) with the (+) side up.

* After replacing the battery, always follow the procedure described in “Setting up the computer” (page 5).

* If you make a note of the total distance value before replacing the battery, you will be able to continue from the same total distance by entering it after replacing the battery.

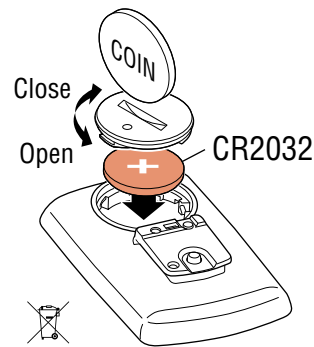

● Speed sensor

When the speed is not displayed even after adjusting correctly, it is time to replace the battery.

Insert a new lithium battery (CR2032) with the (+) side up and close the battery cover firmly.

* After replacing the battery, adjust the position of the magnet relative to the speed sensor as described in “Mounting the computer”(page 4) step 4.

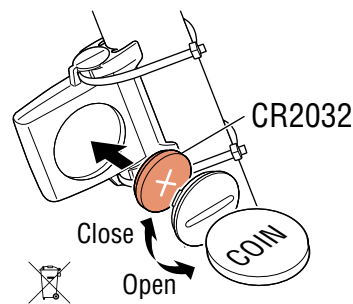

Troubleshooting

Speed is not displayed.

● Is there too much clearance between the speed sensor and the magnet?
(Clearance should be within 5 mm (3/16”).)

● Does the magnet pass through the sensor zone correctly?

Adjust the position of the magnet and/or the speed sensor.

● Is the computer mounted at the correct angle?

Ensure that the back of the computer faces the speed sensor.

● Are the computer and the speed sensor mounted at the correct distance apart?
(Clearance should be from 20 to 70 cm (8” to 27”).)

Ensure that the speed sensor is within range.

● Is the computer or speed sensor battery flat?

* Battery performance diminishes in winter.

If the computer reacts only when it is close to the speed sensor, the problem may be due to weak batteries.

Replace the batteries with new ones as described in “Replacing the battery”.

The display remains blank when the button is pressed.

Replace the computer battery as described in “Replacing the battery”.

Incorrect data appear.

Clear all according to the procedure described in “Setting up the computer”(page 5).

Appendix

Main specifications

Batteries used Battery life	Computer	Lithium battery (CR2032) x1 <ul style="list-style-type: none"> ● If used for one hour a day without backlight illumination: Approx. 1 year (actual battery life will vary depending on usage conditions) ● If used for one hour a day with constant backlight illumination: Approx. 2 months (actual battery life will vary depending on usage conditions)
	Speed sensor	Lithium battery (CR2032) x1 / Total distance approx. 10000 km [6,250 miles]

* Average value when used at temperature of 20 °C with computer and sensor mounted 65 cm apart.

* Frequent use of backlight will cause the computer battery life to be extremely short.

* Life of pre-installed battery may be shorter than indicated above.

Controller	4 bit, 1-chip microcomputer (Crystal controlled oscillator)	
Display	Liquid crystal	
Sensor	Non-contact magnetic sensor	
Signal range	20 to 70 cm (8" to 27")	
Tire circumference range	0100 mm – 3999 mm (Initial value: 2096 mm)	
Operating temperature range	32°F – 104°F (0°C – 40°C) (Guaranteed operating temperature range: Display visibility may deteriorate outside this range.)	
Dimensions/weight	Computer	2-21/32" x 1-11/16" x 9/16" (67.5 x 43 x 14.5 mm) / 1.1 oz (31.5 g)
	Speed sensor	1-5/8" x 1-13/32" x 19/32" (41.5 x 36 x 15 mm) / 0.5 oz (15 g)

* Specifications and design are subject to change without notice.

LIMITED WARRANTY

2-Years Computer/Speed Sensor Only (Accessories and Battery Consumption Excluded)

CatEye cycle computers are warranted to be free of defects from materials and workmanship for a period of two years from original purchase. If the product fails to work due to normal use, CatEye will repair or replace the defect at no charge. Service must be performed by CatEye or an authorized retailer. To return the product, pack it carefully and enclose the warranty certificate (proof of purchase) with instruction for repair. Please write or type your name and address clearly on the warranty certificate. Insurance, handling and transportation charges to CatEye shall be borne by person desiring service.

For UK and REPUBLIC OF IRELAND consumers, please return to the place of purchase. This does not affect your statutory rights.

Please register your CatEye product on the website.
<http://www.cateye.com/us/support/regist/>

CAT EYE CO., LTD.

2-8-25, Kuwazu, Higashi Sumiyoshi-ku, Osaka 546-0041 Japan
Attn: CATEYE Customer Service
Phone : (06)6719-6863 Fax : (06)6719-6033
E-mail : support@cateye.co.jp URL : <http://www.cateye.com>

[For US Customers]

CATEYE AMERICA, INC.

2825 Wilderness Place Suite 1200, Boulder CO 80301-5494 USA
Phone : 303.443.4595 Toll Free : 800.5.CATEYE
Fax : 303.473.0006 E-mail : service@cateye.com

Standard accessories

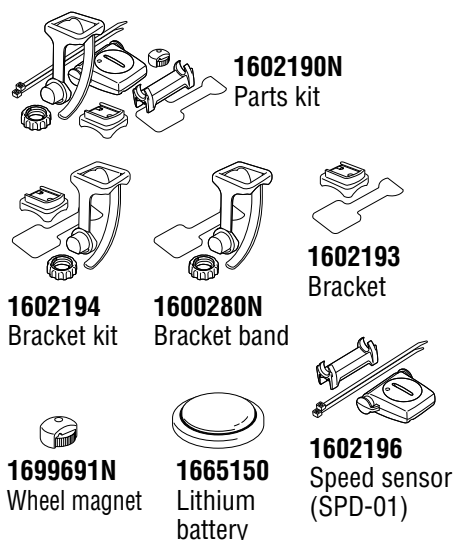

Optional accessories

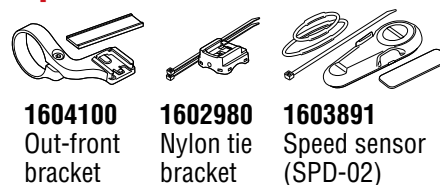

▲ (2/3)

Appendix (3/3)