



# Maintenance and Service Guide

## **SUMMARY**

This guide provides information about spare parts, removal and replacement of parts, security, backing up, and more.

© Copyright 2020 HP Development Company, L.P.

AMD is a trademark of Advanced Micro Devices, Inc. Bluetooth is a trademark owned by its proprietor and used by HP Inc. under license. Intel, Core, Iris, Optane, Thunderbolt, vPro, and XMM are trademarks of Intel Corporation or its subsidiaries in the U.S. and/or other countries. Microsoft and Windows are either registered trademarks or trademarks of Microsoft Corporation in the United States and/or other countries. NVIDIA and Quadro are trademarks and/or registered trademarks of NVIDIA Corporation in the U.S. and other countries. Qualcomm and Snapdragon are trademarks of Qualcomm Incorporated, registered in the United States and other countries, used with permission. USB Type-C and USB-C are registered trademarks of USB Implementers Forum. DisplayPort™ and the DisplayPort™ logo are trademarks owned by the Video Electronics Standards Association (VESA®) in the United States and other countries. Miracast is a registered trademark of Wi-Fi Alliance.

The information contained herein is subject to change without notice. The only warranties for HP products and services are set forth in the express warranty statements accompanying such products and services. Nothing herein should be construed as constituting an additional warranty. HP shall not be liable for technical or editorial errors or omissions contained herein.

First Edition: December 2020

Document Part Number: M17590-001

## Product notice

This guide describes features that are common to most models. Some features may not be available on your computer.

Not all features are available in all editions or versions of Windows. Systems may require upgraded and/or separately purchased hardware, drivers, software or BIOS update to take full advantage of Windows functionality. Windows 10 is automatically updated, which is always enabled. ISP fees may apply and additional requirements may apply over time for updates. Go to <http://www.microsoft.com> for details.

To access the latest user guides, go to <http://www.hp.com/support>, and follow the instructions to find your product. Then select **Manuals**.

## Software terms

By installing, copying, downloading, or otherwise using any software product preinstalled on this computer, you agree to be bound by the terms of the HP End User License Agreement (EULA). If you do not accept these license terms, your sole remedy is to return the entire unused product (hardware and software) within 14 days for a full refund subject to the refund policy of your seller.

For any further information or to request a full refund of the price of the computer, please contact your seller.

## Important notice about Customer Self-Repair parts

Your computer includes Customer Self-Repair parts and parts that should be accessed by only an authorized service provider.



---

**IMPORTANT:** See "Removal and replacement procedures for Customer Self-Repair parts" for details.

Accessing parts described in "Removal and replacement procedures for authorized service provider parts" can damage the computer or void your warranty.

---



## Safety warning notice

Reduce the possibility of heat-related injuries or of overheating the computer by following the practices described.

---

 **WARNING!** To reduce the possibility of heat-related injuries or of overheating the computer, do not place the computer directly on your lap or obstruct the computer air vents. Use the computer only on a hard, flat surface. Do not allow another hard surface, such as an adjoining optional printer, or a soft surface, such as pillows or rugs or clothing, to block airflow. Also, do not allow the AC adapter to come into contact with the skin or a soft surface, such as pillows or rugs or clothing, during operation. The computer and the AC adapter comply with the user-accessible surface temperature limits defined by applicable safety standards.

---



---

# Table of contents

<b>1 Product description .....</b>	<b>1</b>
<b>2 Components .....</b>	<b>6</b>
Right side .....	6
Left side .....	7
Display .....	8
Keyboard area .....	9
Touchpad .....	9
Touchpad settings .....	9
Adjusting touchpad settings .....	9
Turning on the touchpad .....	9
Touchpad components .....	10
Lights .....	10
Button, speakers, vents, and fingerprint reader .....	11
Special keys .....	13
Bottom .....	14
Labels .....	15
Using a SIM card (select products only) .....	16
Inserting a nano SIM card .....	16
Removing a nano SIM card .....	17
<b>3 Illustrated parts catalog .....</b>	<b>18</b>
Computer major components .....	18
Display assembly subcomponents .....	21
Cable Kit .....	22
Bracket Kit .....	23
Plastics Kit .....	24
Miscellaneous parts .....	24
<b>4 Removal and replacement procedures preliminary requirements .....</b>	<b>28</b>
Tools required .....	28
Service considerations .....	28
Plastic parts .....	28
Cables and connectors .....	28
Drive handling .....	28
Electrostatic discharge information .....	29

Generating static electricity .....	29
Preventing electrostatic damage to equipment .....	30
Personal grounding methods and equipment .....	30
Grounding the work area .....	31
Recommended materials and equipment .....	31
Packaging and transporting guidelines .....	32
<b>5 Removal and replacement procedures for Customer Self-Repair parts .....</b>	<b>33</b>
Component replacement procedures .....	33
Preparation for disassembly .....	33
Bottom cover .....	33
Memory modules .....	34
WLAN module .....	37
WWAN module .....	38
Solid-state drive .....	40
<b>6 Removal and replacement procedures for authorized service provider parts .....</b>	<b>43</b>
Component replacement procedures .....	43
Preparation for disassembly .....	43
Battery .....	43
RTC battery .....	45
Speakers .....	46
Card reader board .....	47
Power connector cable .....	48
USB board .....	49
Fingerprint reader board .....	50
Touchpad .....	51
NFC module .....	53
Fan .....	53
Heat sink .....	54
System board .....	57
Display assembly .....	60
Keyboard with top cover .....	76
<b>7 Troubleshooting guide .....</b>	<b>77</b>
Resources .....	77
General troubleshooting steps .....	78
Identify the issue .....	78
1. Understand the issue .....	78
Boot up sequence .....	78



Failure classification .....	79
2. Examine the environment .....	81
3. Perform a visual inspection of hardware .....	81
4. Update BIOS and drivers .....	81
Manually updating BIOS and drivers .....	82
Remotely deploying the BIOS and drivers .....	82
Analyze the issue .....	82
5. Remove or uninstall recently added hardware, software .....	82
6. HP Hardware Diagnostics and Tools .....	82
HP PC Hardware Diagnostics (UEFI) .....	82
HP BIOS Configuration Utility (BCU) .....	84
HP Image Diagnostic Tool .....	85
HP Thermal Monitor .....	85
Non HP diagnostics tools .....	85
7. Status lights, blinking light codes, troubleshooting lights, and POST error messages .....	85
Status lights .....	85
Blinking light codes .....	86
POST error messages .....	87
Resolve the issue .....	88
8. Hard reset .....	88
9. Soft reset (Default Settings) .....	89
10. Reseat cables and connections .....	89
11. Test with minimum configuration .....	90
Essential hardware configuration .....	90
Safe mode .....	90
12. Test with verified working configuration (hardware or operating system) .....	91
13. Replace the system board .....	91
Verify solution .....	92
Helpful Hints .....	92
At startup .....	92
During operation .....	93
Consulting with HP Service .....	93
Common issues and possible solutions .....	94
Power-on issues .....	94
No power .....	94
Intermittent power-on, shutdown, reboot .....	96
AC adapter issue .....	97
Battery not recognized, not charging .....	98
Battery discharges too fast .....	99
Burnt smell .....	100

POST .....	100
No video (with power) .....	100
Blinking lights .....	102
Diagnostic error messages .....	102
BIOS password .....	103
Performance (OS) .....	103
Intermittent shutdown .....	103
Blue screen .....	105
Freeze at Windows Logo (hang or lockup) .....	105
Electromagnetic Interference (EMI) .....	106
No wake up .....	106
Unresponsive .....	107
Slow performance .....	108
HP Smart Adapter warning message .....	108
Incorrect time and date .....	109
Display .....	109
Display anomalies .....	109
Symptom .....	109
Quick check .....	110
HP PC Hardware Diagnostics (UEFI) for video test .....	111
Display assembly diagram .....	111
Dead pixel .....	111
No video (internal) .....	112
No video (external) .....	112
DisplayPort/VGA .....	112
HDMI .....	113
No or bad external video via docking .....	113
Incorrect or missing color/distorted image .....	114
Touch screen .....	114
I/O devices .....	115
Keyboard .....	115
Keyboard pointing stick (select products only) .....	116
Keyboard backlight .....	117
Touchpad .....	117
Network connectivity (RJ-45 jack) .....	118
Network connectivity wireless (WLAN) .....	118
WWAN .....	119
USB .....	119
Smart card reader .....	120
Speaker, headphone - audio issues .....	121
Thunderbolt (TB) .....	122

Storage .....	123
Hard drive or solid-state drive not recognized .....	124
No boot to operating system (no read-write error) .....	125
Read-write error .....	125
Blue screen (BSOD) error .....	126
Noisy hard drive .....	126
Mechanical .....	127
Noise (sound) .....	127
Fan runs constantly .....	128
Thermal shutdown (hot) .....	129
Malfunctioning power button .....	130
Additional information .....	130
Acronyms .....	130
Blinking lights and boot error codes .....	131
Processor not executing code .....	131
BIOS recovery code unable to find valid BIOS recovery image .....	132
Memory module error .....	132
Graphics Controller Error (No Controller) .....	132
Failure System Board Error .....	132
Intel Trusted Execution Technology (TXT) Error .....	132
Sure Start unable to find valid BIOS Boot Block image .....	133
Sure Start has identified a problem (Manual Recovery Policy Set) .....	133
POST error messages and user actions .....	133
Routine maintenance for performance improvement .....	135
Common blue screen error messages .....	136
Error message list .....	136
Bug check symbolic names .....	136
Microsoft general troubleshooting of Windows bug check codes .....	136
Use Windows Debugging Tool .....	137
Windows Software Development Kit (SDK) .....	137
Display issue: pixel anomalies .....	140
Cable management .....	141
Connector types .....	142
Flex cable .....	142
Horizontal cable insertion .....	143
Multiple-pin horizontal connector (LVDS cable to display panel) .....	143
Multiple-pin vertical connector (LVDS cable to system board) .....	143
<b>8 Computer Setup (BIOS), TPM, and HP Sure Start .....</b>	<b>145</b>
Using Computer Setup .....	145
Navigating and selecting in Computer Setup .....	145

Restoring factory settings in Computer Setup .....	145
Updating the BIOS .....	146
Determining the BIOS version .....	146
Preparing for a BIOS update .....	146
Downloading a BIOS update .....	146
Installing a BIOS update .....	147
Changing the boot order using the f9 prompt .....	147
TPM BIOS settings (select products only) .....	147
Using HP Sure Start (select products only) .....	148

## **9 Backing up, restoring, and recovering ..... 149**

Backing up information and creating recovery media .....	149
Using Windows tools for backing up .....	149
Using the HP Cloud Recovery Download Tool to create recovery media (select products only) ...	149
Restoring and recovering your system .....	149
Creating a system restore .....	150
Restoring and recovery methods .....	150
Recovering using HP Recovery media .....	150
Changing the computer boot order .....	150
Using HP Sure Recover (select products only) .....	151

## **10 Using HP PC Hardware Diagnostics ..... 152**

Using HP PC Hardware Diagnostics Windows (select products only) .....	152
Using an HP PC Hardware Diagnostics Windows hardware failure ID code .....	152
Accessing HP PC Hardware Diagnostics Windows .....	152
Accessing HP PC Hardware Diagnostics Windows from HP Help and Support (select products only) .....	152
Accessing HP PC Hardware Diagnostics Windows from Support Assistant .....	153
Accessing HP PC Hardware Diagnostics Windows from the Start menu (select products only) .....	153
Downloading HP PC Hardware Diagnostics Windows .....	153
Downloading the latest HP PC Hardware Diagnostics Windows version from HP .....	153
Downloading the HP PC Hardware Diagnostics Windows from the Microsoft Store ...	153
Downloading HP Hardware Diagnostics Windows by product name or number (select products only) .....	154
Installing HP PC Hardware Diagnostics Windows .....	154
Using HP PC Hardware Diagnostics UEFI .....	154
Using an HP PC Hardware Diagnostics UEFI hardware failure ID code .....	154
Starting HP PC Hardware Diagnostics UEFI .....	155
Downloading HP PC Hardware Diagnostics UEFI to a USB flash drive .....	155
Downloading the latest HP PC Hardware Diagnostics UEFI version .....	155

Downloading HP PC Hardware Diagnostics UEFI by product name or number (select products only) .....	155
Using Remote HP PC Hardware Diagnostics UEFI settings (select products only) .....	156
Downloading Remote HP PC Hardware Diagnostics UEFI .....	156
Downloading the latest Remote HP PC Hardware Diagnostics UEFI version .....	156
Downloading Remote HP PC Hardware Diagnostics UEFI by product name or number .....	156
Customizing Remote HP PC Hardware Diagnostics UEFI settings .....	156
<b>11 Specifications .....</b>	<b>158</b>
Computer specifications .....	158
35.6 cm (14.0 in) display specifications .....	159
Solid-state drive specifications .....	159
<b>12 Statement of memory volatility .....</b>	<b>161</b>
Current BIOS steps .....	161
Nonvolatile memory usage .....	163
Questions and answers .....	165
Using HP Sure Start (select products only) .....	166
<b>13 Power cord set requirements .....</b>	<b>167</b>
Requirements for all countries .....	167
Requirements for specific countries and regions .....	167
<b>14 Recycling .....</b>	<b>169</b>
<b>Index .....</b>	<b>170</b>



# 1 Product description

This table provides detailed product information.

**Table 1-1 Product components and their descriptions**

Category	Description
<b>Product Name</b>	HP ZBook Firefly 14 inch G8 Mobile Workstation PC
<b>Processors</b>	<p><b>Intel® processors</b></p> <p>Intel Core® i7-1165G7</p> <p>Intel Core i5-1135G7</p>
<b>Graphics</b>	<p><b>Internal graphics</b></p> <p>Intel Iris® Xe Graphics</p> <p>Supports HD Decode, DX12, and HDMI 2.0, HDCP 2.2 via HDMI/DisplayPort up to 4 K @ 60 Hz</p> <p><b>Discrete graphics</b></p> <p>NVIDIA® Quadro® P520 graphic controller</p> <p>Supports maximum of three independent displays when on the HP USB-C Dock G5; Max resolution = 4 K @ 30 Hz (DisplayPort 1 and DisplayPort 2)</p> <p>Supports maximum of three independent displays when on the HP Thunderbolt™ Dock 120 W G2 (through USB-C); Max resolution = 4 K @ 30 Hz (DisplayPort 1 and DisplayPort 2)</p>
<b>Display</b>	<p><b>35.6 cm (14.0 in), full high definition (FHD) (1920 × 1080), narrow bezel, UWVA, antiglare, bent, supports privacy filter, nontouch</b></p> <p>250 nits, 45% CG, eDP, no camera</p> <p>250 nits, 45% CG, eDP, HD camera</p> <p>250 nits, 45% CG, eDP, HD + IR camera</p> <p>250 nits, 45% CG, eDP, no camera, WWAN</p> <p>250 nits, 45% CG, eDP, HD camera, WWAN</p> <p>250 nits, 45% CG, eDP, HD + IR camera, WWAN</p> <p>400 nits, 72% CG, eDP + PSR, low power, ambient light sensor, HD + IR camera</p> <p>400 nits, 72% CG, eDP + PSR, low power, ambient light sensor, HD + IR camera, WWAN</p> <p>1000 nits, 72% CG, eDP + PSR, Sure View Gen4, ambient light sensor, HD camera</p> <p>1000 nits, 72% CG, eDP + PSR, Sure View Gen4, ambient light sensor, HD + IR camera</p> <p>1000 nits, 72% CG, eDP + PSR, Sure View Gen4, ambient light sensor, HD camera, WWAN</p> <p>1000 nits, 72% CG, eDP + PSR, Sure View Gen4, ambient light sensor, HD + IR camera, WWAN</p> <p><b>35.6 cm (14.0 in), full high definition (FHD) (1920 × 1080), UWVA, antiglare, bent, touch screen</b></p> <p>250 nits, 45% CG, HD + IR camera, Touch-on panel (TOP)</p> <p>250 nits, 45% CG, HD + IR camera, WWAN, Touch-on panel (TOP)</p>

**Table 1-1 Product components and their descriptions (continued)**

Category	Description
<b>Memory</b>	Two customer-accessible memory module slots supporting up to 64 GB of RAM
	DDR4-3200 dual-channel support
	Supports the following configurations:
	<ul style="list-style-type: none"> <li>64 GB (32 × 2)</li> </ul>
	<ul style="list-style-type: none"> <li>48 GB (32 + 16)</li> </ul>
	<ul style="list-style-type: none"> <li>32 GB (16 × 2)</li> </ul>
	<ul style="list-style-type: none"> <li>24 GB (16 + 8)</li> </ul>
	<ul style="list-style-type: none"> <li>20 GB (16 + 4)</li> </ul>
	<ul style="list-style-type: none"> <li>16 GB (8 × 2) or (16 × 1)</li> </ul>
	<ul style="list-style-type: none"> <li>8 GB (8 + 4)</li> </ul>
<b>Primary storage</b>	<b>M.2 2280 solid-state drives (NGFF)</b>
	2 TB, PCIe, Gen3 × 4, SS, TLC
	1 TB, PCIe, Gen3 × 4, SS, TLC
	512 GB, PCIe, TLC
	512 GB, PCIe-3 × 4, SS, TLC, self-encrypted OPAL2
	512 GB, PCIe, value
	512 GB, PCIe-3 × 2 × 2 + 32 GB Optane™ memory
	256 GB, PCIe-3 × 4, SS, TLC
	256 GB, PCIe-3 × 4, TLC, self-encrypted OPAL2
	256, PCIe, value
	128 GB, PCIe-3 × 2, TLC
	<b>eMMC v5.0</b>
	32 GB
<b>Audio and video</b>	Bang & Olufsen
	Dual speakers
	Microphone (dual-array)
	Microphone (rear-facing)
	Camera, HD RGB 720p
	Camera, HD RGB 720p + IR (infrared)
	Camera privacy cover
	Supports WDR (Wide Dynamic Range)



**Table 1-1 Product components and their descriptions (continued)**

Category	Description
	Support for models without a camera
<b>RJ-45 (network) jack</b>	No direct Ethernet support, available via accessories  The following support S4/S5 wake on LAN (via out of band) and S0/S3/S4/S5 MPAT (via out of band): HP Docking Station, HP USB-C Mini Dock, HP USB-C/A Universal Dock G2, HP USB-C Dock G5, HP Thunderbolt Dock 120 W G2.
<b>Wireless</b>	<b>Wireless Local Area Network (WLAN)</b> (select products only)  Intel Wi-Fi 6 AX201 802.11ax (2 × 2) and Bluetooth® 5 (vPro)  Intel Wi-Fi 6 AX201 802.11ax (2 × 2) and Bluetooth® 5 (non-vPro)  Compatible with Miracast® devices  Two WLAN antennas configured at top of panel  Supports HP Connection Optimizer (with data analytics)  Supports Static BIOS SAR for Intel modules and Realtek modules  Supports HP Extended Range Wireless LAN  Supports HP LAN-Wireless Protection (WLAN/LAN/WWAN switching)  <b>Near Field Communication (NFC)</b> (select products only)  NXP NPC300 Near Field Communication Module  NFC antenna  <b>WWAN</b> (select products only)  Intel XMM™ 7360 LTE-Advanced (Cat 9)  Qualcomm® Snapdragon® X55 LTE + 5G  Four WWAN antennas (worldwide 5 band, 2 at top and 2 at bottom of WWAN panels)  WWAN cards are compatible with a programmable removable eSIM  Supports WWAN after market option
<b>Ports</b>	HDMI 2.0  Audio-out (headphone)/audio-in (microphone) combo jack  (2) USB 3.1 Gen 2 Type-C with alt mode  USB 3.1 Gen 1 port  USB 3.1 Gen 1 charging port  AC Smart Pin adapter plug, 4.5 mm
<b>Sensors</b>	Ambient light sensor (ALS)  Hall sensor  HP Sure Platform
<b>Keyboard/pointing devices</b>	<b>HP Premium Keyboard</b>  Dual point with clickpad, backlit, spill resistant, premium keyboard

**Table 1-1 Product components and their descriptions (continued)**

<b>Category</b>	<b>Description</b>
	Dual point with clickpad, backlit, spill resistant, premium keyboard, privacy
	Dual point with clickpad, not backlit, spill resistant, premium keyboard
	<b>Touchpad</b>
	Firmware PTP
	Microsoft® precision touchpad default gestures support
	No hybrid mode support
<b>Power requirements</b>	<b>Battery</b>
	3 cell, 53 Whr, lithium polymer, HP Long Life
	HP Fast Charge Technology
	<b>Smart AC adapters</b>
	65 W, right angle, 4.5 mm, 1.8 m (5.9 ft)
	65 W, right angle, 4.5 mm (LA Merco)
	65 W, 4.5 mm, EM
	65 W, standard, straight, USB Type-C®, 1.8 m (5.9 ft)
	65 W, slim, straight, USB Type-C
	45 W, right angle, 4.5 mm, 1.8 m (5.9 ft)
	45 W, right angle, 4.5 mm (LA Merco)
	45 W, right angle, 4.5 mm, 2 prong
	<b>Power cord</b>
	C5, 1.0 m (3.3 ft), premium
	C5, 1.0 m (3.3 ft), conventional
	C7, 1.0 m (3.3 ft), conventional
<b>Security</b>	Trusted Platform Module (TPM) 2.0
	Touch fingerprint sensor (select products only)
	Nano security lock
	Camera privacy cover
	Smart card reader (active) (select products only)
<b>Operating system</b>	Windows® 10 Enterprise 64
	Windows 10 Enterprise 64 LTSC 1809
	Windows 10 Home 64
	Windows 10 Home 64 Advanced
	Windows 10 Home 64 Advanced Single Language
	Windows 10 Home 64 High-End Chinese Market CPPP

**Table 1-1 Product components and their descriptions (continued)**

<b>Category</b>	<b>Description</b>
	Windows 10 Home 64 Plus
	Windows 10 Home 64 Plus Single Language
	Windows 10 Home 64 Plus Single Language Africa Market PPP
	Windows 10 Home 64 Plus Single Language APAC EM PPP
	Windows 10 Home 64 Plus Single Language India Market PPP
	Windows 10 Home 64 Plus Single Language Indonesia Market PPP
	Windows 10 Pro 64
	Windows 10 Pro 64 Chinese Market
	Windows 10 Pro 64 CBB 1903
	Windows 10 Pro 64 CBB 1909
	FreeDOS 3.0
	<b>Restore media</b>
	Windows 10 Driver DVD
	Windows 10 Driver USB
	Windows 10 Cloud Recovery Client
<b>Serviceability</b>	<b>End user replaceable parts</b>
	AC adapter
	Memory module
	Solid-state drive
	WLAN module
	WWAN module

## 2 Components



Your computer features top-rated components. This chapter provides details about your components, where they are located, and how they work.

### Right side

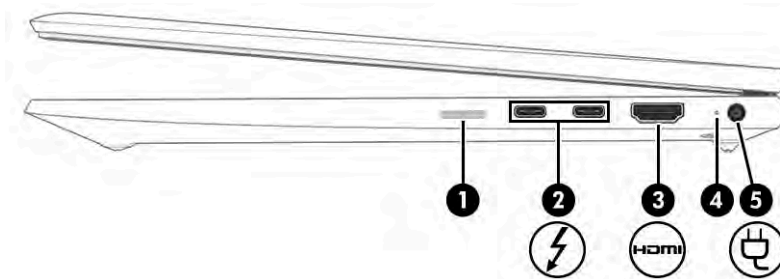
Use the illustration and table to identify the components on the right side of the computer.



**Table 2-1 Right-side components and their descriptions**

Component	Description
(1)	<p>nano SIM card reader (select products only)</p> <p>Supports a wireless subscriber identity module (nano SIM) card.</p> <p><b>IMPORTANT:</b> Inserting a SIM card of the wrong size could damage the SIM card or cause the SIM card to become stuck in the slot. The use of SIM card adapters is not recommended. To prevent damage to the SIM card or the connectors, use minimal force when inserting a SIM card.</p> <p>For installation steps, see <a href="#">Inserting a nano SIM card on page 16</a>.</p>
(2)	<p> USB Type-C® power connector and Thunderbolt™ ports (2) with HP Sleep and Charge</p> <p>Connect an AC adapter that has a USB Type-C connector, supplying power to the computer and, if needed, charging the computer battery.</p> <p>– and –</p> <p>Connect a USB device, provide high-speed data transfer, and charge small devices (such as a smartphone), even when the computer is off.</p> <p>– and –</p> <p>Connect a display device that has a USB Type-C connector, providing DisplayPort™ output.</p> <p><b>NOTE:</b> Your computer might also support a Thunderbolt docking station.</p> <p><b>NOTE:</b> Use a standard USB Type-C charging cable or cable adapter (purchased separately) when charging a small external device.</p>
(3)	<p> HDMI port</p> <p>Connects an optional video or audio device, such as a high-definition television, any compatible digital or audio component, or a high-speed High Definition Multimedia Interface (HDMI) device.</p>

**Table 2-1 Right-side components and their descriptions (continued)**



Component	Description
(4) Battery light	<p>When AC power is connected:</p> <ul style="list-style-type: none"> <li>White: The battery charge is greater than 90%.</li> <li>Amber: The battery charge is from 0 to 90%.</li> <li>Off: The battery is not charging.</li> </ul> <p>When AC power is disconnected (battery not charging):</p> <ul style="list-style-type: none"> <li>Blinking amber: The battery has reached a low battery level. When the battery has reached a critical battery level, the battery light begins blinking rapidly.</li> <li>Off: The battery is not charging.</li> </ul>
(5)  Power connector	Connects an AC adapter.

## Left side

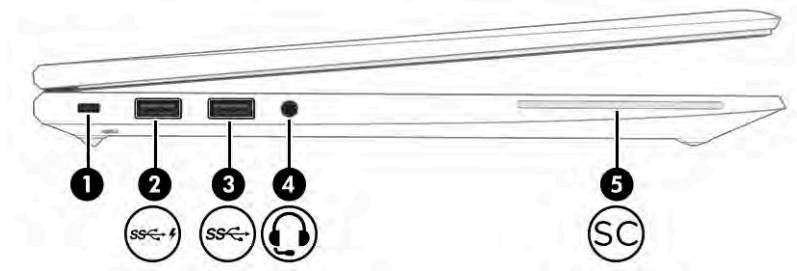
Use the illustration and table to identify the components on the left side of the computer.



**Table 2-2 Left-side components and their descriptions**

Component	Description
(1) Security cable slot	<p>Attaches an optional security cable to the computer.</p> <p><b>NOTE:</b> The security cable is designed to act as a deterrent, but it might not prevent the computer from being mishandled or stolen.</p>
(2)  USB SuperSpeed port with HP Sleep and Charge	Connects a USB device, provides high-speed data transfer, and charges small devices, even when the computer is off.
(3)  USB SuperSpeed port	Connects a USB device, provides high-speed data transfer, and (for select products) charges small devices when the computer is on or in Sleep mode.
(4)  Audio-out (headphone)/Audio-in (microphone) combo jack	Connects optional powered stereo speakers, headphones, earbuds, a headset, or a television audio cable. Also connects an optional headset microphone. This jack does not support optional standalone microphones.

**Table 2-2 Left-side components and their descriptions (continued)**

Component	Description
	<p><b>WARNING!</b> To reduce the risk of personal injury, adjust the volume before putting on headphones, earbuds, or a headset. For additional safety information, see the <i>Regulatory, Safety, and Environmental Notices</i>.</p> <p>To access this guide:</p> <ul style="list-style-type: none"> <li>▲ Type <b>HP Documentation</b> in the taskbar search box, and then select <b>HP Documentation</b>.</li> </ul> <p><b>NOTE:</b> When a device is connected to the jack, the computer speakers are disabled.</p>
(5) SC Smart card reader	Supports optional smart cards.

## Display

Use the illustration and table to identify the display components.

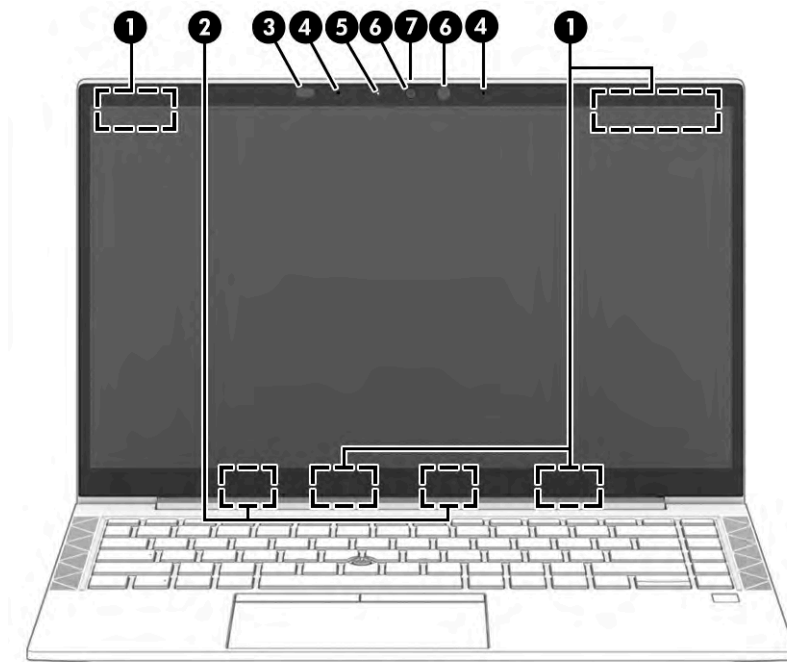

**Table 2-3 Display components and their descriptions**

Component	Description
(1) WWAN antennas* (select products only)	Send and receive wireless signals to communicate with wireless wide area networks (WWANs).
(2) WLAN antennas* (select products only)	Send and receive wireless signals to communicate with wireless local area networks (WLANs).
(3) Ambient light sensor (select products only)	Adjusts the brightness of the display, depending on the ambient light.
(4) Internal microphones (2)	Record sound.

**Table 2-3 Display components and their descriptions (continued)**

Component	Description
(5) Camera light(s) (select products only)	On: One or more cameras are in use.
(6) Camera (select products only)	Allows you to video chat, record video, and record still images. Some cameras also allow a facial recognition logon to Windows, instead of a password logon. <b>NOTE:</b> Camera functions vary depending on the camera hardware and software installed on your product.
(7) Camera privacy cover (select products only)	By default, the camera lens is uncovered, but you can slide the camera privacy cover to block the camera's view. To use the camera, slide the camera privacy cover in the opposite direction to reveal the lens. <b>NOTE:</b> If you have both front-facing and rear-facing cameras, when one camera lens is revealed and ready to use, the other is concealed.

\*The antennas are not visible from the outside of the computer. For optimal transmission, keep the areas immediately around the antennas free from obstructions.

For wireless regulatory notices, see the section of the *Regulatory, Safety, and Environmental Notices* that applies to your country or region.

To access this guide:

▲ Type `HP Documentation` in the taskbar search box, and then select **HP Documentation**.

## Keyboard area

Keyboards can vary by language.

## Touchpad

The touchpad settings and components are described here.

### Touchpad settings

You learn how to adjust the touchpad settings and components here.

#### Adjusting touchpad settings

Use these steps to adjust touchpad settings and gestures.

1. Type `touchpad settings` in the taskbar search box, and then press [enter](#).
2. Choose a setting.

#### Turning on the touchpad

Follow these steps to turn on the touchpad.

1. Type `touchpad settings` in the taskbar search box, and then press [enter](#).
2. Using an external mouse, click the **Touchpad** button.

If you are not using an external mouse, press the **Tab** key repeatedly until the pointer rests on the **touchpad** button. Then press the [spacebar](#) to select the button.

## Touchpad components

Use the illustration and table to identify the touchpad components.

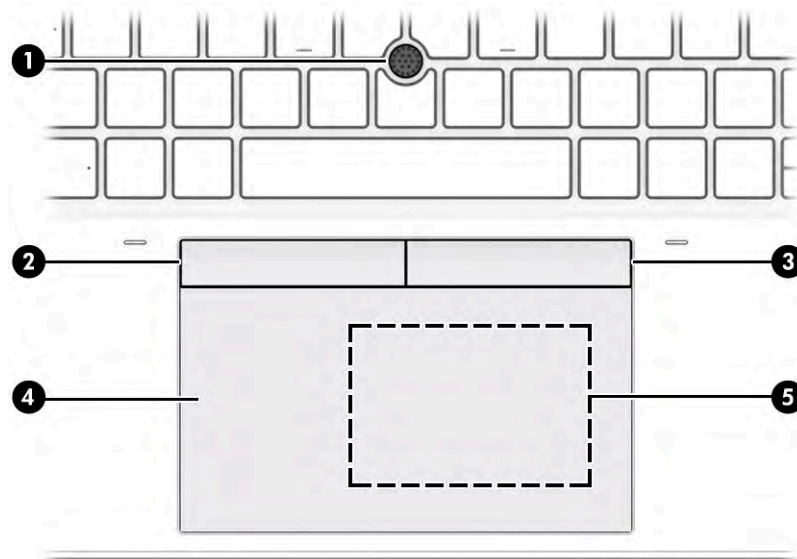

**Table 2-4 Touchpad components and their descriptions**

Component	Description
(1) Pointing stick	Moves the pointer on the screen.
(2) Left pointing stick button	Functions like the left button on an external mouse.
(3) Right pointing stick button	Functions like the right button on an external mouse.
(4) Touchpad zone	Reads your finger gestures to move the pointer or activate items on the screen.
(5) Near Field Communications (NFC) tapping area and antenna (select products only)	Allows you to wirelessly share information when you tap it with an NFC-enabled device.



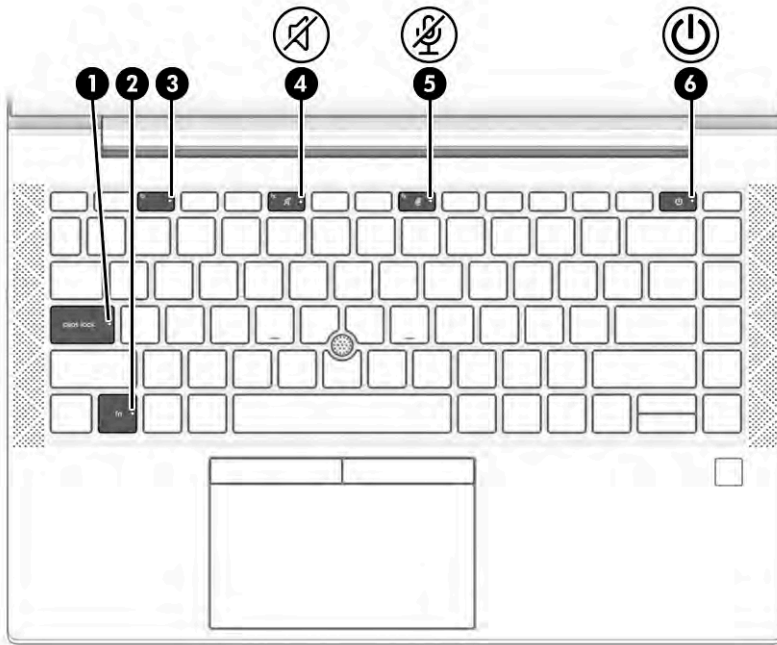

## Lights

Use the illustration and table to identify the lights on the computer.





**Table 2-5 Lights and their descriptions**

Component	Description
(1) Caps lock light	On: Caps lock is on, which switches the key input to all capital letters.
(2) Fn lock light	On: The <b>fn</b> key is locked.
(3)  Privacy key light (select products only)	On: Privacy screen is on, which helps prevent side-angle viewing.
(4)  Mute light	<ul style="list-style-type: none"> <li>On: Computer sound is off.</li> <li>Off: Computer sound is on.</li> </ul>
(5)  Microphone mute light	<ul style="list-style-type: none"> <li>On: Microphone is off.</li> <li>Off: Microphone is on.</li> </ul>
(6)  Power light	<ul style="list-style-type: none"> <li>On: The computer is on.</li> <li>Blinking (select products only): The computer is in the Sleep state, a power-saving state. The computer shuts off power to the display and other unnecessary components.</li> <li>Off: Depending on your computer model, the computer is off, in Hibernation, or in Sleep. Hibernation is the power-saving state that uses the least amount of power.</li> </ul>



## Button, speakers, vents, and fingerprint reader

Fingerprint readers can be located on the touchpad, on a side panel of the computer, or on the top cover below the keyboard.

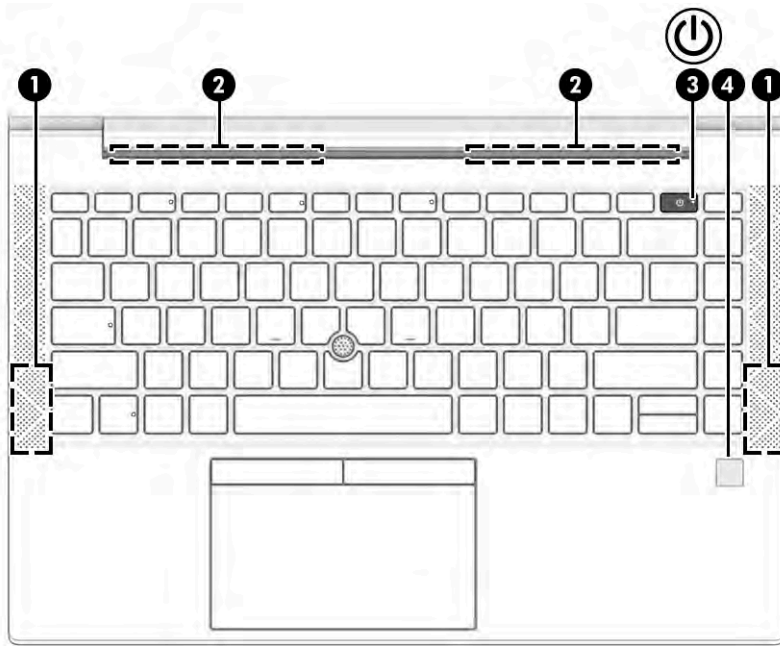
 **IMPORTANT:** To verify that your computer supports fingerprint reader sign-in, type `Sign-in options` in the taskbar search box and follow the on-screen instructions. If **Fingerprint reader** is not listed as an option, then your notebook does not include a fingerprint reader.



**Table 2-6 Button, speakers, and fingerprint reader and their descriptions**

Component	Description
(1) Speakers (2)	Produce sound.
(2) Vents (2)	Enable airflow to cool internal components. <b>NOTE:</b> The computer fan starts up automatically to cool internal components and prevent overheating. It is normal for the internal fan to cycle on and off during routine operation.
(3)  Power button	<ul style="list-style-type: none"> <li>• When the computer is off, press the button briefly to turn on the computer.</li> <li>• When the computer is on, press the button briefly to initiate Sleep.</li> <li>• When the computer is in the Sleep state, press the button briefly to exit Sleep (select products only).</li> <li>• When the computer is in Hibernation, press the button briefly to exit Hibernation.</li> </ul> <p><b>IMPORTANT:</b> Pressing and holding down the power button results in the loss of unsaved information.</p> <p>If the computer has stopped responding and shutdown procedures are ineffective, press and hold the power button for at least 4 seconds to turn off the computer.</p> <p>To learn more about your power settings, see your power options.</p> <p>▲ Right-click the <b>Power meter</b> icon  and then select <b>Power Options</b>.</p>
(4) Fingerprint reader (select products only)	<p>Allows a fingerprint logon to Windows, instead of a password logon.</p> <p>▲ Touch your finger to the fingerprint reader.</p>

**Table 2-6 Button, speakers, and fingerprint reader and their descriptions (continued)**



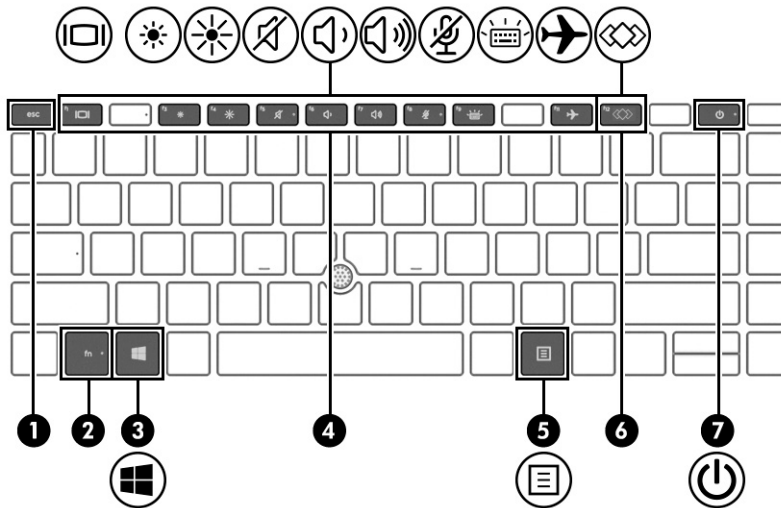

Component	Description
	<b>IMPORTANT:</b> To prevent fingerprint logon issues, make sure when you register your fingerprint that all sides of your finger are registered by the fingerprint reader.

## Special keys

Use the illustration and table to identify the special keys.



**Table 2-7 Special keys and their descriptions**

Component	Description
(1) <code>esc</code> key	Displays system information when pressed in combination with the <code>fn</code> key.
(2) <code>fn</code> key	Executes frequently used system functions when pressed in combination with another key. Such key combinations are called <i>hot keys</i> .
(3)  Windows key	Opens the Start menu. <b>NOTE:</b> Pressing the Windows key again will close the Start menu.
(4) Action keys	Execute frequently used system functions.
(5)  Windows application key (select products only)	Displays options for a selected object.
(6)  Programmable key	Executes frequently used tasks. Some tasks might not be available on all products.
(7)  Power button	<ul style="list-style-type: none"> <li>When the computer is off, press the button briefly to turn on the computer.</li> <li>When the computer is on, press the button briefly to initiate Sleep.</li> </ul>

**Table 2-7 Special keys and their descriptions (continued)**

Component	Description
	<ul style="list-style-type: none"><li>• When the computer is in the Sleep state, press the button briefly to exit Sleep (select products only).</li><li>• When the computer is in Hibernation, press the button briefly to exit Hibernation.</li></ul> <p><b>IMPORTANT:</b> Pressing and holding down the power button results in the loss of unsaved information.</p> <p>If the computer has stopped responding and shutdown procedures are ineffective, press and hold the power button for at least 4 seconds to turn off the computer.</p> <p>To learn more about your power settings, see your power options.</p> <p>▲ Right-click the <b>Power meter</b> icon  and then select <b>Power Options</b>.</p>

## Bottom

Use the illustration and table to identify the bottom component.



**NOTE:** Vent size might vary.

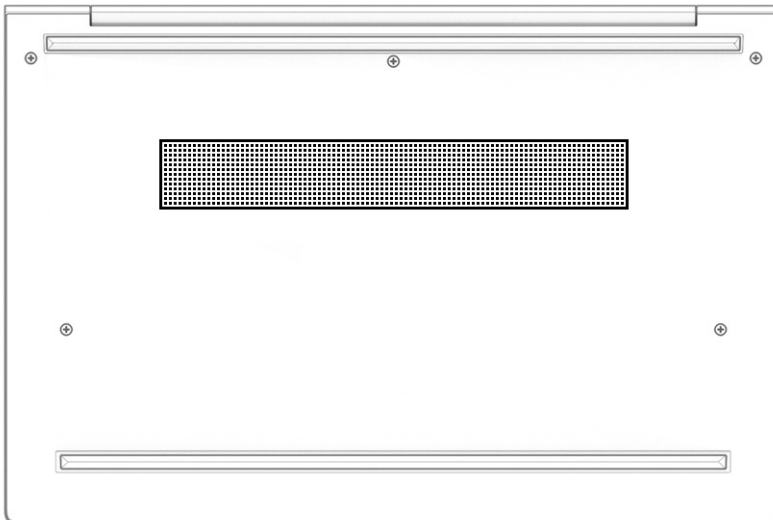

**Table 2-8 Bottom component and its description**

Component	Description
Vent	<p>Enables airflow to cool internal components.</p> <p><b>NOTE:</b> The computer fan starts up automatically to cool internal components and prevent overheating. It is normal for the internal fan to cycle on and off during routine operation.</p>

# Labels

The labels affixed to the computer provide information you might need when you troubleshoot system problems or travel internationally with the computer. Labels might be in paper form or imprinted on the product.

**IMPORTANT:** Check the following locations for the labels described in this section: the bottom of the computer, inside the battery bay, under the service door, on the back of the display, or on the bottom of a tablet kickstand.

- **Service label**—Provides important information to identify your computer. When contacting support, you might be asked for the serial number, the product number, or the model number. Locate this information before you contact support.

Your service label will resemble one of these examples. Refer to the illustration that most closely matches the service label on your computer.

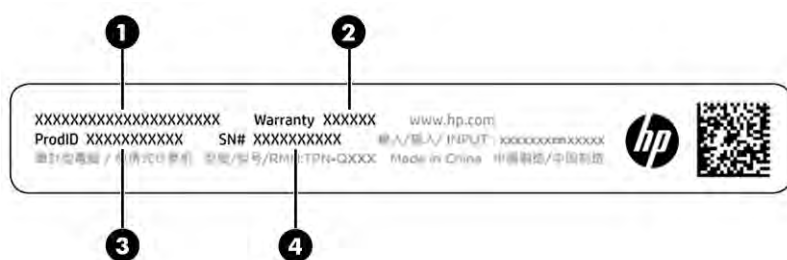

**Table 2-9 Service label components**

Component	
(1)	HP product name
(2)	Warranty period
(3)	Product ID
(4)	Serial number

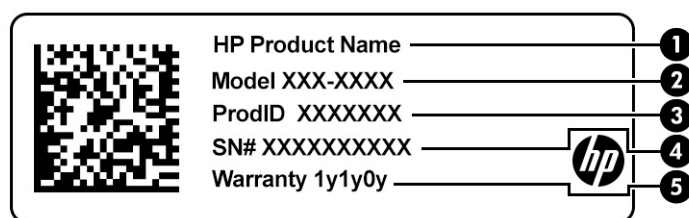
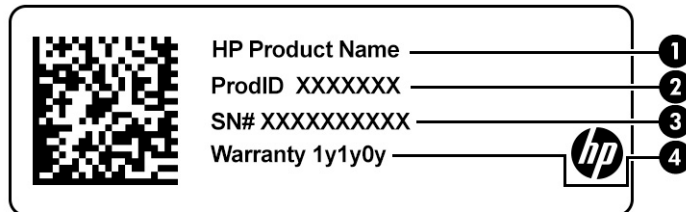

**Table 2-10 Service label components**

Component	
(1)	HP product name
(2)	Model number
(3)	Product ID

**Table 2-10 Service label components (continued)**

Component	
(4)	Serial number
(5)	Warranty period



**Table 2-11 Service label components**

Component	
(1)	HP product name
(2)	Product ID
(3)	Serial number
(4)	Warranty period

- Regulatory labels—Provide regulatory information about the computer.
- Wireless certification labels—Provide information about optional wireless devices and the approval markings for the countries or regions in which the devices have been approved for use.

## Using a SIM card (select products only)

Use these instructions to insert a SIM card.

 **IMPORTANT:** You can damage the SIM card if you insert the wrong size card or insert it or the SIM card tray in the wrong direction. The card might also become stuck in the slot. Do not use SIM card adapters. To prevent damage to the SIM card or connectors, use minimal force when inserting or removing a SIM card.

### Inserting a nano SIM card

To insert a nano SIM card, follow these steps:

1. Position the computer display-side up on a flat surface.
2. Press in gently on the SIM card access tray to disengage the SIM lock, and the tray will pop out of the slot (1).
3. Remove the tray (2) from the computer and insert the card (3).

4. Replace the tray in the computer. Press in gently on the tray **(4)** until it is firmly seated.

 **NOTE:** SIM tray appearance might vary.

---

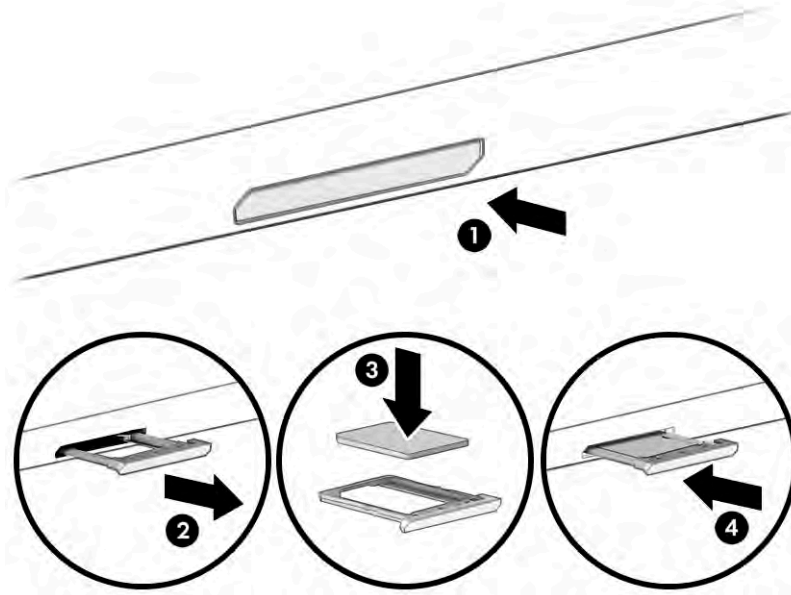

## Removing a nano SIM card

Follow these steps to remove a nano SIM card.

1. Release the card tray as described above, and then remove the card.
2. Replace the tray in the computer. Press in gently on the tray until it is firmly seated.

# 3 Illustrated parts catalog

Use this table to determine the spare parts that are available for the computer.

## Computer major components

To identify the computer major components, use this illustration and table.

**NOTE:** HP continually improves and changes product parts. For complete and current information about supported parts for your computer, go to <http://partsurfer.hp.com>, select your country or region, and then follow the on-screen instructions.

**NOTE:** Details about your computer, including model, serial number, product key, and length of warranty, are on the service tag at the bottom of your computer.

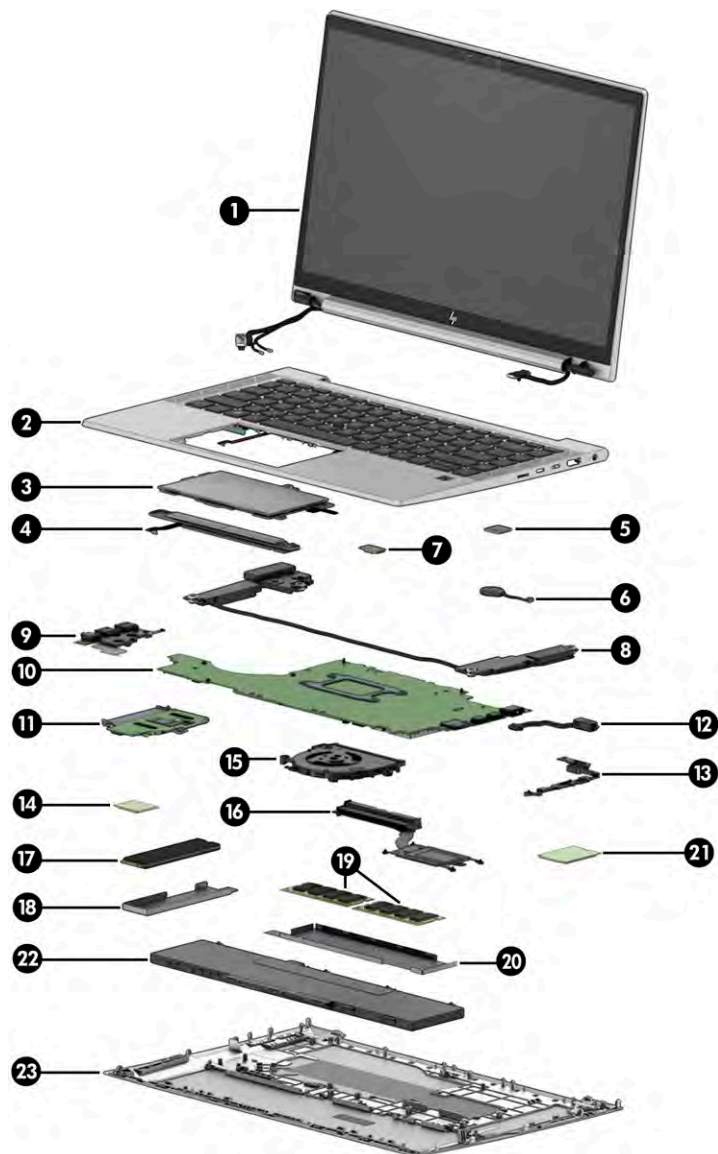



**Table 3-1 Computer major component descriptions and part numbers**

Item	Component	Spare part number
(1)	<b>Display assembly</b> <b>NOTE:</b> Display spare parts are available only as subcomponents. For spare part information, see <a href="#">Display assembly subcomponents on page 21</a> .	not available as a spare part
(2)	<b>Top cover/keyboard</b> <b>NOTE:</b> For a detailed list of country codes, see <a href="#">Keyboard with top cover on page 76</a> .  For use in models with UMA graphics memory:	
	• Backlit	M36447-xx1
	• Not backlit	M36445-xx1
	• Backlit, for use in privacy models	M36446-xx1
	For use in models with discrete graphics memory:	
	• Backlit	M44366-xx1
	• Not backlit	M44364-xx1
	• Backlit, for use in privacy models	M44365-xx1
(3)	<b>Touchpad</b>	
	Without NFC antenna	M42239-001
	Includes NFC antenna	M42240-001
(4)	<b>Touchpad button board</b>	M07106-001
	For use in models with UMA graphics memory	M07147-001
	For use in models with discrete graphics memory	M07148-001
(5)	<b>Fingerprint reader</b> <b>NOTE:</b> The fingerprint reader cable is available in the Cable Kit as spare part number M07101-001.	M36444-001
(6)	<b>RTC battery</b>	L13694-001
(7)	<b>NFC module</b> <b>NOTE:</b> The NFC module cable is available in the Cable Kit as spare part number M07101-001.	M07214-001
(8)	<b>Speakers</b> (left and right)	M07107-001
(9)	<b>USB board</b> <b>NOTE:</b> The USB board cable is available in the Cable Kit as spare part number M07101-001.	M36398-001
(10)	<b>System board</b> (includes integrated processor) <b>NOTE:</b> All system board spare part kits include replacement thermal material. All system boards use the following part numbers: xxxxxx-001: Non-Windows operating systems xxxxxx-601: Windows operating system  For use in models with UMA graphics memory:	
	• Intel Core i7-1165G7	M36402-xx1

**Table 3-1 Computer major component descriptions and part numbers (continued)**

<b>Item</b>	<b>Component</b>	<b>Spare part number</b>
	<ul style="list-style-type: none"> <li>Intel Core i5-1135G7</li> </ul>	M36401-xx1
	For use in models with discrete graphics memory:	
	<ul style="list-style-type: none"> <li>Intel Core i7-1165G7 and 32 GB of system memory</li> </ul>	M36454-xx1
	<ul style="list-style-type: none"> <li>Intel Core i7-1165G7 and 16 GB of system memory</li> </ul>	M36453-xx1
	<ul style="list-style-type: none"> <li>Intel Core i5-1135G7 and 16 GB of system memory</li> </ul>	M36448-xx1
	<ul style="list-style-type: none"> <li>Intel Core i5-1135G7 and 8 GB of system memory</li> </ul>	M36449-xx1
<b>(11)</b>	<b>Card reader board</b>	M07105-001
	<b>NOTE:</b> The card reader board cable is available in the Cable Kit as spare part number M07101-001.	
<b>(12)</b>	<b>Power connector cable</b>	M15626-001
<b>(13)</b>	<b>System board bracket</b> (available in Plastics Kit)	M07215-001
<b>(14)</b>	<b>WLAN module</b>	
	Intel Wi-Fi 6 AX201 802.11ax (2 × 2) and Bluetooth 5 (non-vPro)	L92724-002
<b>(15)</b>	<b>Fan</b>	
	For use in models with UMA graphics memory	M07102-001
	For use in models with discrete graphics memory	M36936-001
	<b>Heat sink</b> (includes replacement thermal material)	
<b>(16)</b>	For use in models with UMA graphics memory	M07204-001
	For use in models with discrete graphics memory	M36443-001
<b>(17)</b>	<b>Solid-state drive</b>	
	512 GB, PCIe, TLC, self-encrypting drive (SED)	L85368-002
	512 GB, PCIe + 32 GB Optane memory	L85366-002
	256 GB, PCIe, TLC, self-encrypting drive (SED)	M07245-002
	256 GB, PCIe, value	L85354-002
	128 GB, PCIe, TLC	M06792-002
<b>(18)</b>	<b>Solid-state drive cover</b> (included in Bracket Kit)	M07145-001
<b>(19)</b>	<b>Memory modules</b> (DDR4, PC-3200)	
	32 GB	M09713-002
	16 GB	L67710-002
	8 GB	L46598-002
<b>(20)</b>	<b>Memory cover</b> (included in Bracket Kit)	M07145-001
<b>(21)</b>	<b>WWAN module</b>	
	Intel XMM 7360 LTE-Advanced (Cat 9)	L70670-002
	Qualcomm Snapdragon X55 LTE + 5G	L83053-002

**Table 3-1 Computer major component descriptions and part numbers (continued)**

Item	Component	Spare part number
(22)	<b>Battery</b> (3 cell, 53 Whr)	L78555-005
(23)	<b>Bottom cover</b>	
	For use in models with UMA graphics memory	M36441-001
	For use in models with discrete graphics memory	M36442-001

## Display assembly subcomponents

To identify the display assembly subcomponents, use this illustration and table.

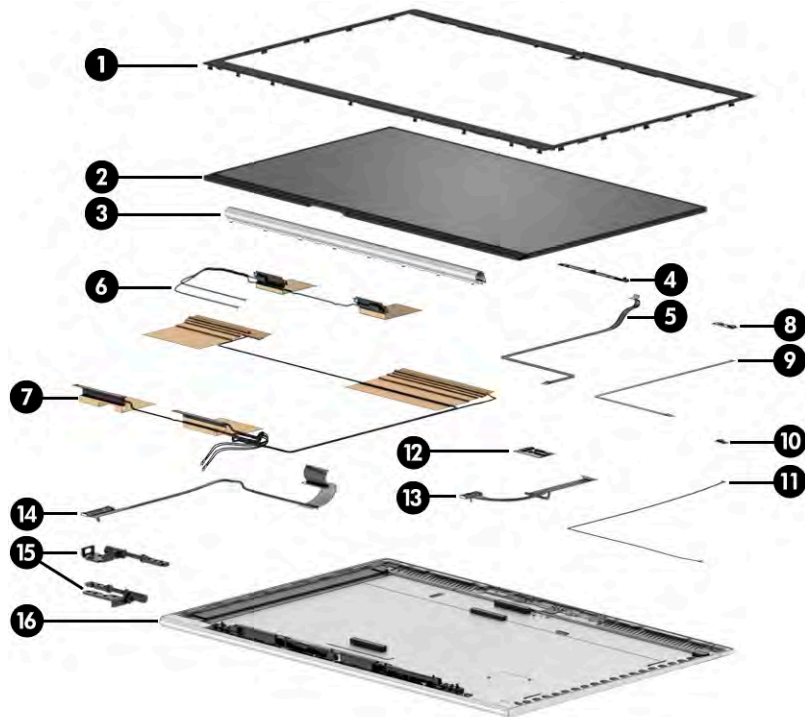

**Table 3-2 Display component descriptions and part numbers**

Item	Component	Spare part number
(1)	<b>Bezel</b>	
	For use in models with an IR camera and ambient light sensor	M07163-001
	For use in models with an IR camera	M07164-001
	For use in models with an RGB camera and ambient light sensor	M07165-001
	For use in models with an RGB camera	M07166-001
	For use in models with a microphone module (no camera)	M07100-001
(2)	<b>Display panel</b>	
	1000 nits	M36316-001

**Table 3-2 Display component descriptions and part numbers (continued)**

<b>Item</b>	<b>Component</b>	<b>Spare part number</b>
	250 nits	M36315-001
	250 nits, Touch-on Panel (TOP)	M36314-001
	400 nits	M36313-001
<b>(3)</b>	<b>Hinge cover</b> (included in Hinge Kit)	M07146-001
<b>(4)</b>	<b>Camera module</b>	
	RGB camera	M07216-001
	IR camera	M08549-001
<b>(5)</b>	<b>Camera cable</b> (included in Cable Kit)	M07101-001
<b>(6)</b>	<b>WLAN antennas and cables</b>	
<b>(7)</b>	<b>WWAN antennas and cables</b>	
<b>(8)</b>	<b>Ambient light sensor</b>	M07212-001
<b>(9)</b>	<b>Ambient light sensor board to hub board cable</b> (included in Cable Kit)	M07101-001
<b>(10)</b>	<b>Microphone module</b>	M07208-001
	<b>Third microphone module</b>	M07209-001
<b>(11)</b>	<b>Microphone board cable</b> (included in Cable Kit)	M07101-001
<b>(12)</b>	<b>Hub board</b>	
	For use in models with an RGB camera or microphone module	M07210-001
	For use in models with an IR camera	M07211-001
<b>(13)</b>	<b>Hub board cable</b> (included in Display Cable Kit)	M07203-001
<b>(14)</b>	<b>Display cable</b> (included in Display Cable Kit)	M07203-001
<b>(15)</b>	<b>Hinges</b> (left and right)	M07146-001
<b>(16)</b>	<b>Display back cover</b>	
	Models with WWAN, privacy, 400 nit panel	M36440-001
	Models without WWAN, privacy, 400 nit panel	M36438-001
	Models without WWAN, 250 nit, Touch-on-Panel (TOP)	M36437-001
	Models with WWAN, 250 nit panel, Touch-on-Panel (TOP)	M36439-001
	<b>Second ambient light sensor</b> (not illustrated)	M07213-001
	<b>Second ambient light sensor to display panel cable</b> (included in Cable Kit; not illustrated)	M07101-001
	<b>Second ambient light sensor to hub board cable</b> (included in Cable Kit; not illustrated)	M07101-001

## Cable Kit

To identify the contents of the Cable Kit, use this table.

**Table 3-3 Cable Kit content descriptions and part number**

Component	Spare part number
<b>Cable Kit</b> , includes:	M07101-001
Hub board to system board cable	
Third microphone board to hub board cable	
IR camera to hub board cable	
Ambient light sensor to hub board cable	
Ambient light sensor to hub board cable (privacy models with WWAN)	
Ambient light sensor to display panel (privacy models with WWAN)	
Dual ambient light sensor to hub board cable	
Dual ambient light sensor to display panel cable	
Touchpad cable	
Fingerprint reader board cable	
Smart card reader to system board cable	
NFC module to system board cable	
USB board to system board cable	
Camera/microphone module to hub board cable	

## Bracket Kit

To identify the Bracket Kit components, use this illustration and table.

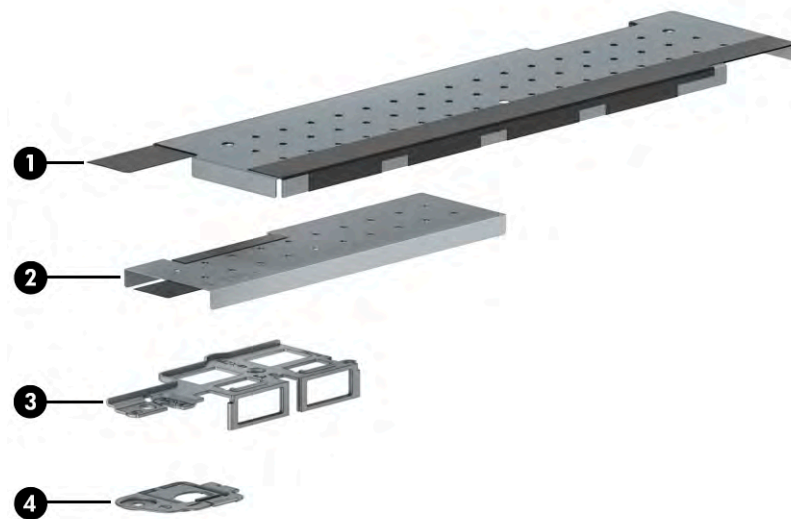
**Table 3-4 Bracket Kit component descriptions and part numbers**

Item	Component	Spare part number
	<b>Bracket Kit</b> , includes:	M08556-001

**Table 3-4 Bracket Kit component descriptions and part numbers (continued)**

Item	Component	Spare part number
(1)	Memory cover	
(2)	Solid-state drive cover	
(3)	USB bracket	
(4)	Fingerprint reader bracket	
	SIM tray (not illustrated)	

## Plastics Kit

To identify the Plastics Kit components, use this illustration and table.

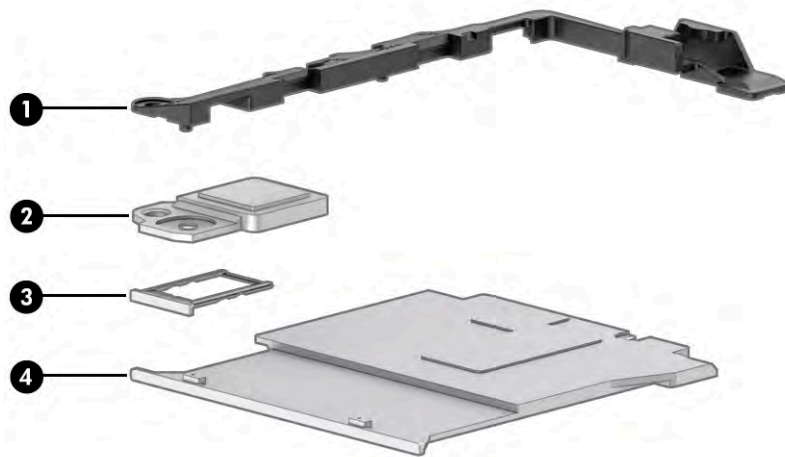
**Table 3-5 Plastics Kit component descriptions and part numbers**

Item	Component	Spare part number
	<b>Plastics Kit</b> , includes:	M07215-001
(1)	I/O frame	
(2)	Fingerprint reader insert	
(3)	SIM card insert	
(4)	Smart card reader insert	
	WWAN insulator (not illustrated)	

## Miscellaneous parts

To identify the miscellaneous parts, use this table.

**Table 3-6 Miscellaneous part descriptions and part numbers**

Component	Spare part number
<b>AC adapters</b>	

**Table 3-6 Miscellaneous part descriptions and part numbers (continued)**

<b>Component</b>	<b>Spare part number</b>
65 W, nPFC, USB-C, RC, 1.8 m (5.9 ft)	L32392-001
65 W, nPFC, USB-C, 1.8 m (5.9 ft)	L67440-001
65 W, nPFC, 3 pin, 4.5 mm	710412-001
65 W, nPFC, SMART, RC, 4.5 mm, EM	913691-850
65 W, nPFC, slim, USB-c, straght, 1.8 m (5.9 ft)	L04650-850
45 W, nPFC, SMART, RC, 4.5 mm, nonslim	741727-001
45 W, nPFC, SMART, RC, 4.5 mm, 2 pin	742436-001
45 W, nPFC, wall mount, USB-C, 1.8 m (5.9 ft)	L32390-001
<b>Screw Kit</b>	M07205-001
<b>Power adapter, duckhead, CNS</b>	
South Korea	L50818-001
North America	L50818-002
<b>Power adapter, duckhead</b>	
Japan	L33157-001
<b>Power cord (C7, conventional, 1.0 m [3.3 ft])</b>	
Japan	L19375-001
<b>Power cord (C5, conventional, 1.8 m [6.0 ft])</b>	
Argentina	L19357-002
Australia	L19358-002
Brazil	L19359-002
Denmark	L19360-002
Europe (Austria, Belgium, Finland, France, Germany, the Netherlands, Norway, and Sweden)	L19361-002
India	L19363-002
Israel	L19362-002
Italy	L19364-002
Japan	L19365-002
North America	L19367-002
People's Republic of China	L19368-002
South Africa	L19369-002
South Korea	L19366-002
Switzerland	L19370-002
Taiwan	L19372-002
Thailand	L19371-002

**Table 3-6 Miscellaneous part descriptions and part numbers (continued)**

<b>Component</b>	<b>Spare part number</b>
The United Kingdom	L19373-002
<b>Power cord (C5, 1.0 m [3.3 ft], STK, premium)</b>	
Argentina	920689-003
Australia	L30769-001
Brazil	L30770-001
Denmark	L30771-001
Europe (Austria, Belgium, Finland, France, Germany, the Netherlands, Norway, and Sweden)	L30772-001
India	920689-016
Israel	L30773-001
Italy	L30774-001
Japan	L30775-001
North America	920689-001
The People's Republic of China	920689-014
South Africa	L30777-001
South Korea	L30776-001
Switzerland	L30778-001
Taiwan	L30780-001
Thailand	L30779-001
United Kingdom	L30781-001
<b>Power cord (C5, 1.0 m [3.3 ft], TAG, conventional)</b>	
Argentina	L31379-001
Australia	L31380-001
Brazil	L31381-001
Denmark	L31382-001
Europe (Austria, Belgium, Finland, France, Germany, the Netherlands, Norway, and Sweden)	L31383-001
Israel	L31384-001
Italy	L31386-001
Japan	L31387-001
North America	L31389-001
People's Republic of China	L31390-001
South Africa	L31391-001
South Korea	L31388-001
Switzerland	L31392-001



**Table 3-6 Miscellaneous part descriptions and part numbers (continued)**

<b>Component</b>	<b>Spare part number</b>
Taiwan	L31394-001
Thailand	L31393-001
The United Kingdom	L31395-001
<b>Power cord</b> (C5, fixed duckhead, premium, 1.0 m [3.3 ft])	
Argentina	L36815-001
Australia	L36816-001
Brazil	L44789-001
Denmark	L36817-001
Europe (Austria, Belgium, Finland, France, Germany, the Netherlands, Norway, and Sweden)	L36818-001
India	L36820-001
Israel	L36819-001
Italy	L44788-001
North America	L36822-001
People's Republic of China	L36823-001
South Africa	L36824-001
Switzerland	L36825-001
Taiwan	L36827-001
Thailand	L36826-001
United Kingdom	L36828-001

---

# 4 Removal and replacement procedures preliminary requirements

Use this information to properly prepare to disassemble and reassemble the computer.

## Tools required

You need the following tools to complete the removal and replacement procedures:

- Tweezers
- Nonconductive, nonmarking pry tool
- Magnetic Phillips P1 screwdriver

## Service considerations

The following sections include some of the considerations that you must keep in mind during disassembly and assembly procedures.



---

**NOTE:** As you remove each subassembly from the computer, place the subassembly (and all accompanying screws) away from the work area to prevent damage.

---

## Plastic parts

Using excessive force during disassembly and reassembly can damage plastic parts.

## Cables and connectors

Handle cables with extreme care to avoid damage.



---

**IMPORTANT:** When servicing the computer, be sure that cables are placed in their proper locations during the reassembly process. Improper cable placement can damage the computer.

---

Apply only the tension required to unseat or seat the cables during removal and insertion. Handle cables by the connector whenever possible. In all cases, avoid bending, twisting, or tearing cables. Be sure that cables are routed so that they cannot be caught or snagged as you remove or replace parts. Handle flex cables with extreme care; these cables tear easily.

## Drive handling

Note the following guidelines when handling drives.

---

 **IMPORTANT:** Drives are fragile components. Handle them with care. To prevent damage to the computer, damage to a drive, or loss of information, observe these precautions:

Before removing or inserting a hard drive, shut down the computer. If you are unsure whether the computer is off or in Hibernation, turn the computer on, and then shut it down through the operating system.

Before handling a drive, be sure that you are discharged of static electricity. While handling a drive, avoid touching the connector.

Before removing an optical drive, be sure that a disc is not in the drive, and be sure that the optical drive tray is closed.

Handle drives on surfaces covered with at least 2.54 cm (1 inch) of shock-proof foam.

Avoid dropping drives from any height onto any surface.

After removing a hard drive or an optical drive, place it in a static-proof bag.

Avoid exposing an internal hard drive to products that have magnetic fields, such as monitors or speakers.

Avoid exposing a drive to temperature extremes or liquids.

If a drive must be mailed, place the drive in a bubble pack mailer or other suitable form of protective packaging, and label the package "FRAGILE."

---

## Electrostatic discharge information

A sudden discharge of static electricity from your finger or other conductor can destroy static-sensitive devices or microcircuitry. Often the spark is neither felt nor heard, but damage occurs. An electronic device exposed to electrostatic discharge (ESD) might not appear to be affected at all and can work perfectly throughout a normal cycle. The device might function normally for a while, but it has been degraded in the internal layers, reducing its life expectancy.

Networks built into many integrated circuits provide some protection, but in many cases, the discharge contains enough power to alter device parameters or melt silicon junctions.

---

 **IMPORTANT:** To prevent damage to the device when you remove or install internal components, observe these precautions:

Keep components in their electrostatic-safe containers until you are ready to install them.

Before touching an electronic component, discharge static electricity by using the guidelines described [Personal grounding methods and equipment on page 30](#).

Avoid touching pins, leads, and circuitry. Handle electronic components as little as possible.

If you remove a component, place it in an electrostatic-safe container.

---

## Generating static electricity

Follow these static electricity guidelines.

- Different activities generate different amounts of static electricity.
- Static electricity increases as humidity decreases.

**Table 4-1** Static electricity occurrence based on activity and humidity

Event	Relative humidity		
	55%	40%	10%
Walking across carpet	7,500 V	15,000 V	35,000 V

**Table 4-1 Static electricity occurrence based on activity and humidity (continued)**

	Relative humidity		
Walking across vinyl floor	3,000 V	5,000 V	12,000 V
Motions of bench worker	400 V	800 V	6,000 V
Removing DIPs (dual in-line packages) from plastic tube	400 V	700 V	2,000 V
Removing DIPs from vinyl tray	2,000 V	4,000 V	11,500 V
Removing DIPs from polystyrene foam	3,500 V	5,000 V	14,500 V
Removing bubble pack from PCB (printed circuit board)	7,000 V	20,000 V	26,500 V
Packing PCBs in foam-lined box	5,000 V	11,000 V	21,000 V

Multiple electric components can be packaged together in plastic tubes, trays, or polystyrene foam.



**NOTE:** As little as 700 V can degrade a product.

## Preventing electrostatic damage to equipment

Many electronic components are sensitive to ESD. Circuitry design and structure determine the degree of sensitivity. The following packaging and grounding precautions are necessary to prevent static electricity damage to electronic components.

- To avoid hand contact, transport products in static-safe containers such as tubes, bags, or boxes.
- Protect all electrostatic parts and assemblies with conductive or approved containers or packaging.
- Keep electrostatic-sensitive parts in their containers until they arrive at static-free stations.
- Place items on a grounded surface before removing them from their container.
- Always be properly grounded when touching a sensitive component or assembly.
- Avoid contact with pins, leads, or circuitry.
- Place reusable electrostatic-sensitive parts from assemblies in protective packaging or conductive foam.

## Personal grounding methods and equipment

Using certain equipment can prevent static electricity damage to electronic components.

- **Wrist straps** are flexible straps with a maximum of 1 M $\Omega$   $\pm$ 10% resistance in the ground cords. To provide proper ground, a strap must be worn snug against bare skin. The ground cord must be connected and fit snugly into the banana plug connector on the grounding mat or workstation.
- **Heel straps/Toe straps/Boot straps** can be used at standing workstations and are compatible with most types of shoes or boots. On conductive floors or dissipative floor mats, use them on both feet with a maximum of 1 M $\Omega$   $\pm$ 10% resistance between the operator and ground.

**Table 4-2 Static shielding protection levels**

Static shielding protection levels	
Method	Voltage
Antistatic plastic	1,500

**Table 4-2 Static shielding protection levels (continued)**

Static shielding protection levels	
Carbon-loaded plastic	7,500
Metallized laminate	15,000

## Grounding the work area

To prevent static damage at the work area, follow these precautions.

- Cover the work surface with approved static-dissipative material.
- Use a wrist strap connected to a properly grounded work surface and use properly grounded tools and equipment.
- Use static-dissipative mats, foot straps, or air ionizers to give added protection.
- Handle electrostatic sensitive components, parts, and assemblies by the case or PCB laminate. Handle them only at static-free work areas.
- Turn off power and input signals before inserting and removing connectors or test equipment.
- Use fixtures made of static-safe materials when fixtures must directly contact dissipative surfaces.
- Keep the work area free of nonconductive materials, such as ordinary plastic assembly aids and polystyrene foam.
- Use conductive field service tools, such as cutters, screwdrivers, and vacuums.
- Avoid contact with pins, leads, or circuitry.

## Recommended materials and equipment

HP recommends certain materials and equipment to prevent static electricity.

- Antistatic tape
- Antistatic smocks, aprons, or sleeve protectors
- Conductive bins and other assembly or soldering aids
- Conductive foam
- Conductive tabletop workstations with ground cord of  $1\text{ M}\Omega \pm 10\%$  resistance
- Static-dissipative table or floor mats with hard tie to ground
- Field service kits
- Static awareness labels
- Wrist straps and footwear straps providing  $1\text{ M}\Omega \pm 10\%$  resistance
- Material handling packages
- Conductive plastic bags
- Conductive plastic tubes
- Conductive tote boxes
- Opaque shielding bags

- Transparent metallized shielding bags
- Transparent shielding tubes

## Packaging and transporting guidelines

Follow these grounding guidelines when packaging and transporting equipment.

- To avoid hand contact, transport products in static-safe tubes, bags, or boxes.
- Protect ESD-sensitive parts and assemblies with conductive or approved containers or packaging.
- Keep ESD-sensitive parts in their containers until the parts arrive at static-free workstations.
- Place items on a grounded surface before removing items from their containers.
- Always be properly grounded when touching a component or assembly.
- Store reusable ESD-sensitive parts from assemblies in protective packaging or nonconductive foam.
- Use transporters and conveyors made of antistatic belts and roller bushings. Be sure that mechanized equipment used for moving materials is wired to ground and that proper materials are selected to avoid static charging. When grounding is not possible, use an ionizer to dissipate electric charges.

# 5 Removal and replacement procedures for Customer Self-Repair parts

This chapter provides removal and replacement procedures for Customer Self-Repair parts.

 **NOTE:** The Customer Self-Repair program is not available in all locations. Installing a part that is not supported by the Customer Self-Repair program can void your warranty. Check your warranty to determine whether Customer Self-Repair is supported in your location.

## Component replacement procedures

To remove and replace computer components, use these procedures.

 **NOTE:** Details about your computer, including model, serial number, product key, and length of warranty, are on the service tag at the bottom of your computer.

 **NOTE:** HP continually improves and changes product parts. For complete and current information about supported parts for your computer, go to <http://partsurfer.hp.com>, select your country or region, and then follow the on-screen instructions.

You must remove, replace, or loosen as many as 8 screws when you service Customer Self-Repair parts. Make special note of each screw size and location during removal and replacement.

## Preparation for disassembly

To prepare to disassemble the computer, use these steps.

See [Removal and replacement procedures preliminary requirements on page 28](#) for initial safety procedures.

1. Turn off the computer. If you are unsure whether the computer is off or in Hibernation, turn the computer on, and then shut it down through the operating system.
2. Disconnect the power from the computer by unplugging the power cord from the computer.
3. Disconnect all external devices from the computer.

## Bottom cover

To remove the bottom cover, use this procedure and illustration.

**Table 5-1 Bottom cover description and part number**

Description	Spare part number
Bottom cover for use in models with UMA graphics memory	M36441-001
Bottom cover for use in models with discrete graphics memory	M36442-001

Before removing the bottom cover, prepare the computer for disassembly ([Preparation for disassembly on page 33](#)).

Remove the bottom cover:

1. Loosen the five captive Phillips screws that secure the bottom cover to the computer.

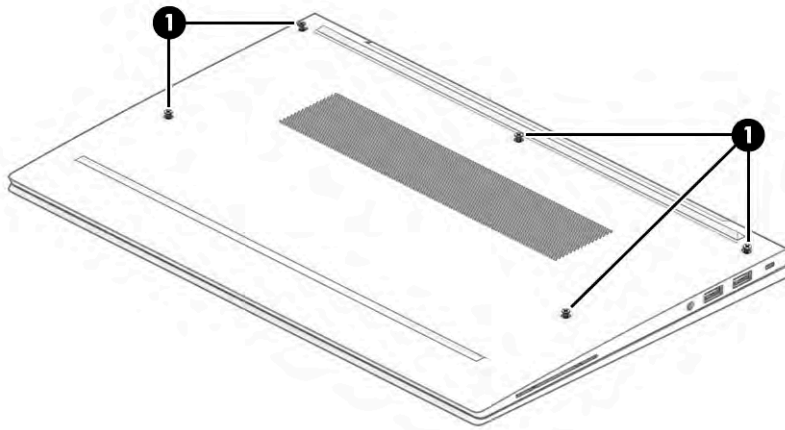

2. Starting near the hinges, use a nonmarking, nonconductive tool to release the edges of the bottom cover from the computer (1).
3. Remove the bottom cover from the computer (2).

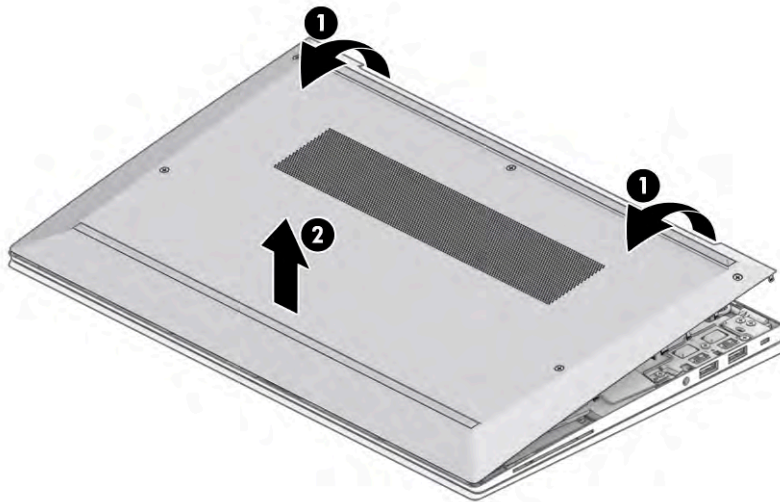

To replace the bottom cover, reverse the removal procedures.

## Memory modules

To remove the memory modules, use this procedure and illustration.

**Table 5-2 Memory module descriptions and part numbers**

Description	Spare part number
32 GB, DDR4-3200	M09713-002
16 GB, DDR4-3200	L67710-002
8 GB, DDR4-3200	L46598-002
Memory module cover (included in Bracket Kit)	M07145-001



Before removing the memory, follow these steps:

1. Prepare the computer for disassembly ([Preparation for disassembly on page 33](#)).
2. Remove the bottom cover ([Bottom cover on page 33](#)).
3. Disconnect the battery cable from the system board (see [Battery on page 43](#)).

If you are replacing a memory module, remove the existing memory module:

1. Use the tab **(1)** to lift the cover off the memory modules **(2)**. The cover is held in place by clips on the system board.

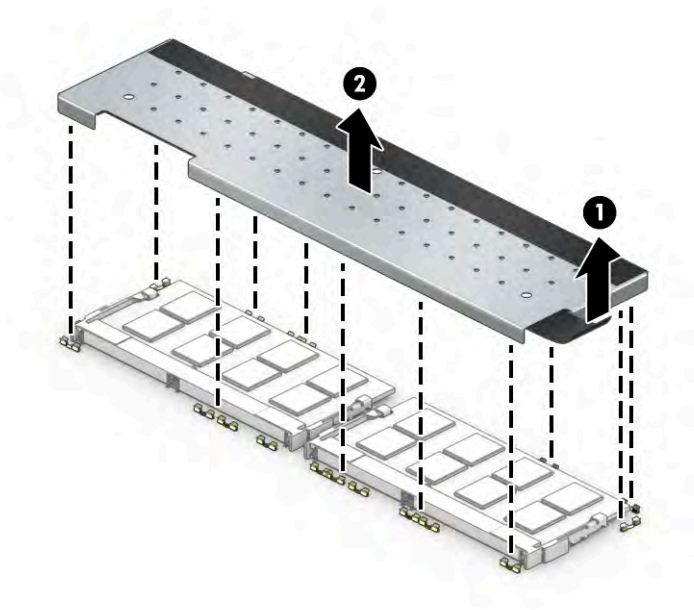

2. Spread the two retention clips outward **(1)** until the memory module tilts up at a 45° angle, and then remove the module **(2)**. Use the same procedure to remove all memory modules.

 **IMPORTANT:** To prevent damage to the memory module, hold the memory module by the edges only. Do not touch the components on the memory module.

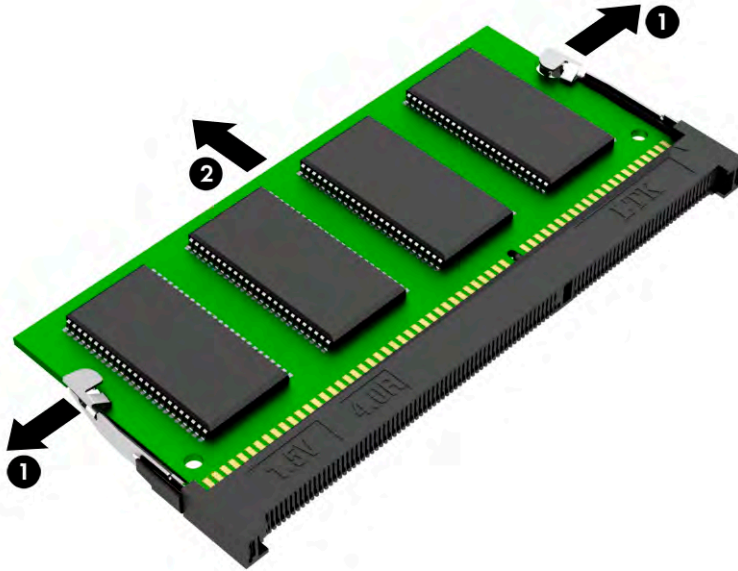

To protect a memory module after removal, place it in an electrostatic-safe container.

To install a memory module:

1. Align the notched edge of the module with the tab in the slot **(1)**, and then press the module into the slot at an angle until it is seated **(2)**.
2. Press down on the module until the side retention clips snap into place **(3)**.

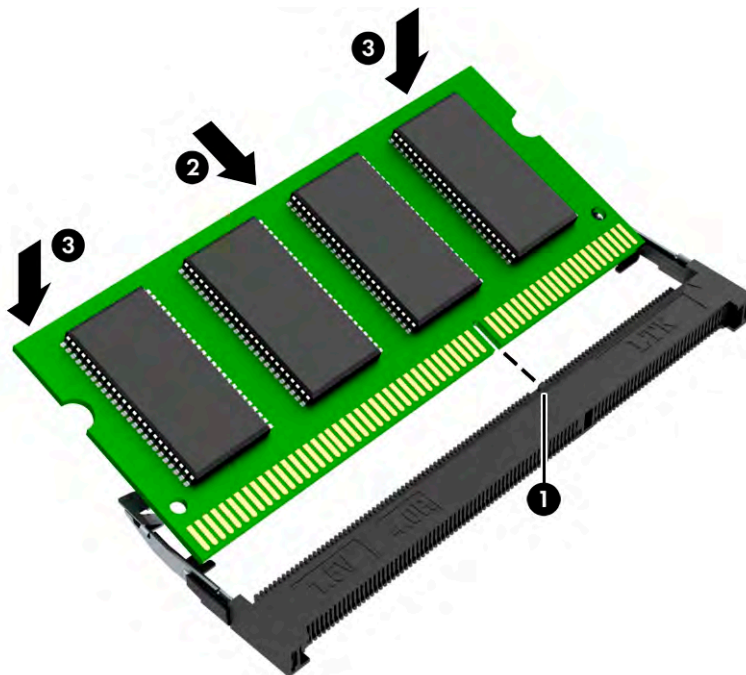

3. Replace the cover by inserting the edges of the cover into the clips on the system board that surround the memory modules **(1)**.

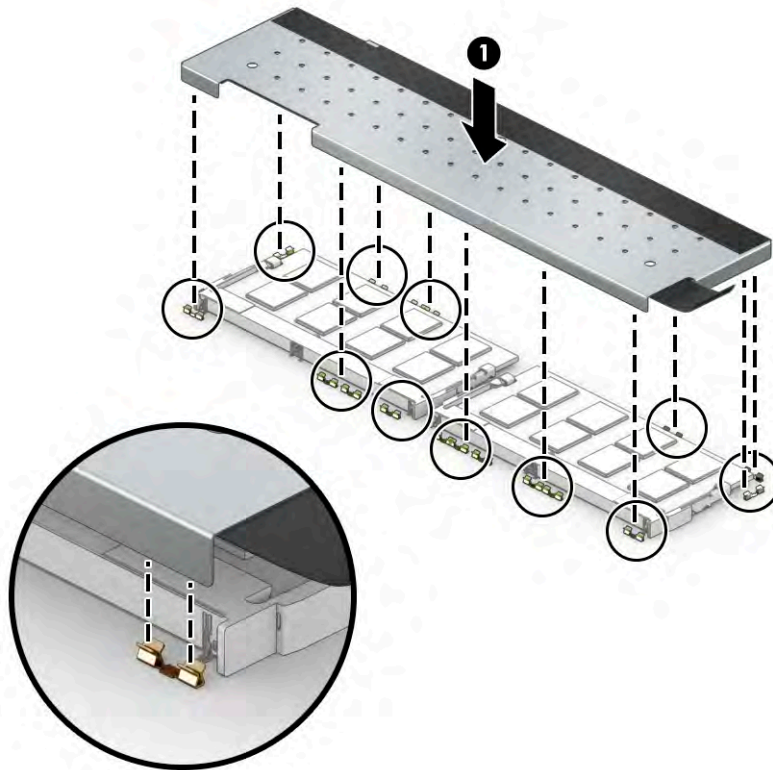

## WLAN module

To remove the WLAN module, use this procedure and illustration.

**Table 5-3 WLAN module descriptions and part numbers**

Description	Spare part number
Intel Wi-Fi 6 AX201 802.11ax (2 × 2) and Bluetooth 5 (non-vPro)	L92724-002

**IMPORTANT:** To prevent an unresponsive system, replace the wireless module only with a wireless module authorized for use in the computer by the governmental agency that regulates wireless devices in your country or region. If you replace the module and then receive a warning message, remove the module to restore device functionality, and then contact technical support.

Before removing the WLAN module, follow these steps:

1. Prepare the computer for disassembly ([Preparation for disassembly on page 33](#)).
2. Remove the bottom cover ([Bottom cover on page 33](#)).
3. Disconnect the battery cable from the system board (see [Battery on page 43](#)).

Remove the WLAN module:

1. Carefully disconnect the two antenna cables from the module **(1)**.

2. Remove the Phillips M2.0 × 2.5 screw (2), and then remove the WLAN module (3).

 **NOTE:** Models have either one or two WLAN antennas. On models with two antennas, the #1 white WLAN antenna cable connects to the WLAN module #1 Main terminal. The #2 black WLAN antenna cable connects to the WLAN module #1 Aux terminal.

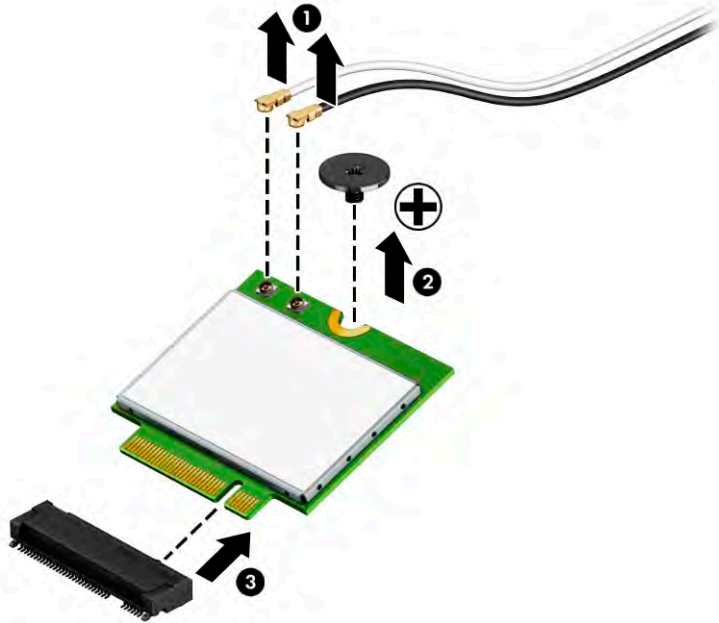

3. If the WLAN antenna is not connected to the terminal on the WLAN module, install a protective sleeve on the antenna connector, as shown in the following illustration.

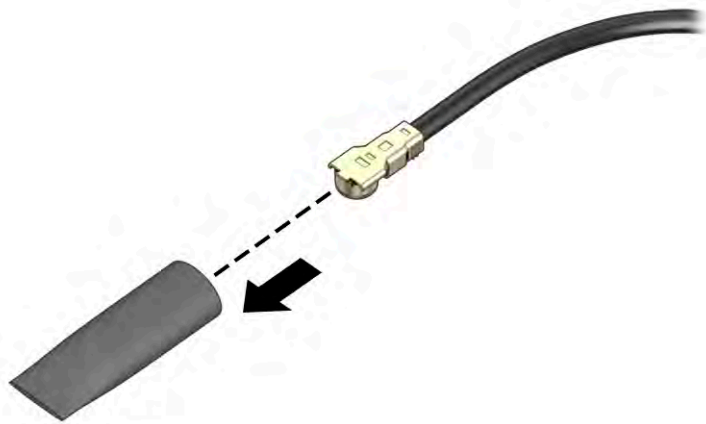

Reverse this procedure to install the WLAN module.

## WWAN module

To remove the WWAN module, use this procedure and illustration.

**Table 5-4 WWAN module descriptions and part numbers**

Description	Spare part number
Intel XMM 7360 LTE-Advanced (Cat 9)	L70670-002
Qualcomm Snapdragon X55 LTE + 5G	L83053-002

 **IMPORTANT:** To prevent an unresponsive system, replace the wireless module only with a wireless module authorized for use in the computer by the governmental agency that regulates wireless devices in your country or region. If you replace the module and then receive a warning message, remove the module to restore device functionality, and then contact technical support.

Before removing the WWAN module, follow these steps:

1. Prepare the computer for disassembly ([Preparation for disassembly on page 33](#)).
2. Remove the bottom cover ([Bottom cover on page 33](#)).
3. Disconnect the battery cable from the system board (see [Battery on page 43](#)).

Remove the WWAN module:

1. Disconnect the WWAN antenna cables **(1)** from the terminals on the WWAN module.
2. Remove the Phillips M2.0 × 2.0 screw **(2)** that secures the WWAN module to the bottom cover. (The WWAN module tilts up.)
3. Remove the WWAN module **(3)** by pulling the module away from the slot at an angle.

 **NOTE:** When viewed with the antenna terminals at the top of the module, the white WWAN antenna cables connects to the terminal to the left of the black WWAN antenna cables.

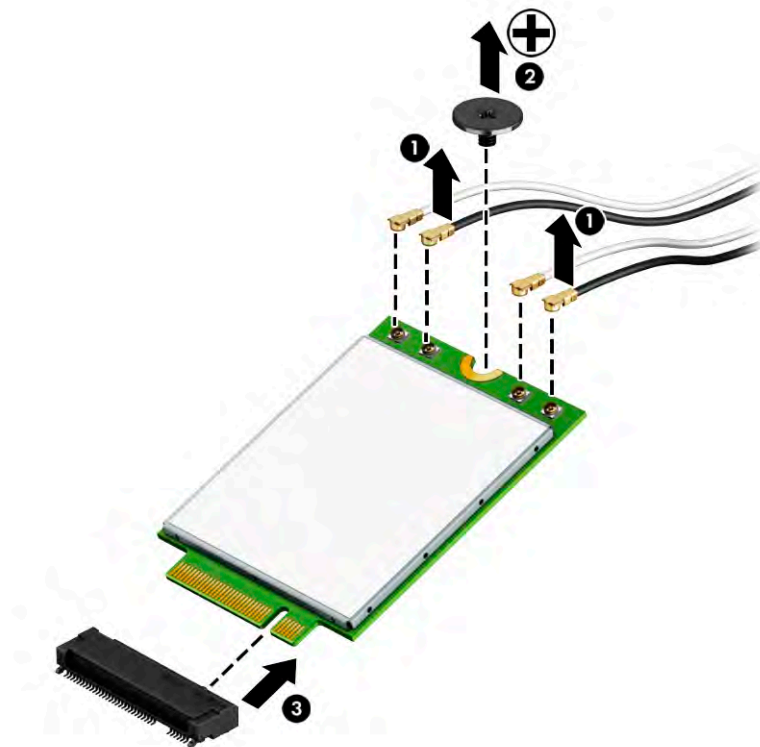

4. If the WWAN antenna is not connected to the terminal on the WWAN module, a protective sleeve must be installed on the antenna connector, as shown in the following illustration.

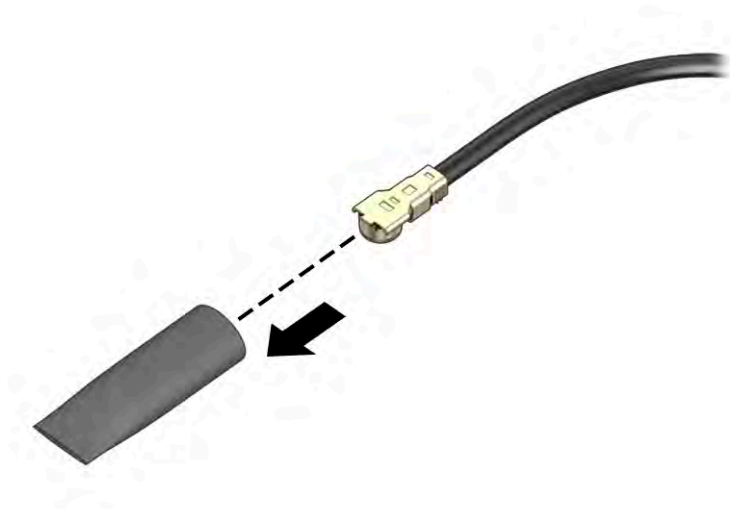

Reverse this procedure to install the WWAN module.

## Solid-state drive

To remove the M.2 solid-state drive, use this procedure and illustration.

**Table 5-5 Solid-state drive descriptions and part numbers**

Description	Spare part number
512 GB, PCIe, TLC, self-encrypting drive (SED)	L85368-002
512 GB, PCIe + 32 GB Optane memory	L85366-002
256 GB, PCIe, TLC, self-encrypting drive (SED)	M07245-002
256 GB, PCIe, value	L85354-002
128 GB, PCIe, TLC	M06792-002
Solid-state drive cover (included in Bracket Kit)	M07145-001

Before removing the solid-state drive, follow these steps:

1. Prepare the computer for disassembly ([Preparation for disassembly on page 33](#)).
2. Remove the bottom cover ([Bottom cover on page 33](#)).
3. Disconnect the battery cable from the system board (see [Battery on page 43](#)).

Remove the solid-state drive:

- ▲ Use the tab **(1)** to lift the cover off the solid-state drive **(2)**. The cover is held in place by clips on the system board.

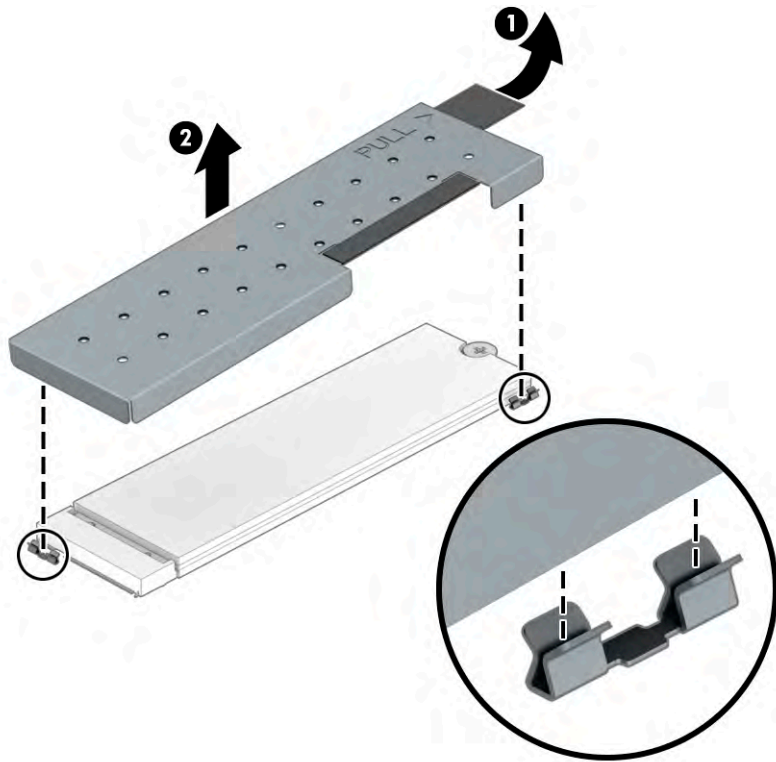

1. Remove the Phillips M2.0 × 2.5 screw **(1)** that secures the drive to the computer.
2. Pull the drive away from the socket to remove it **(2)**.

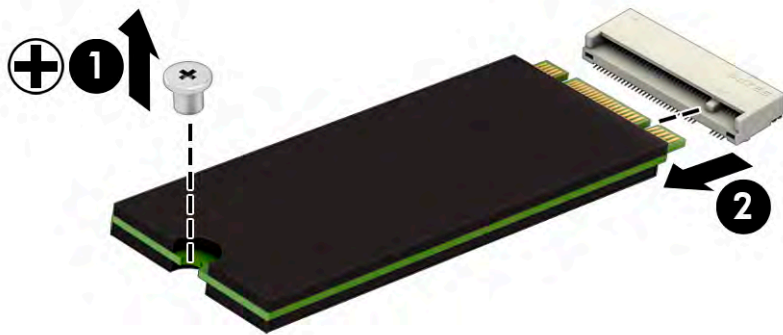

3. Replace the cover by inserting the edges of the cover into the clips on the system board near the sides of the solid-state drive.

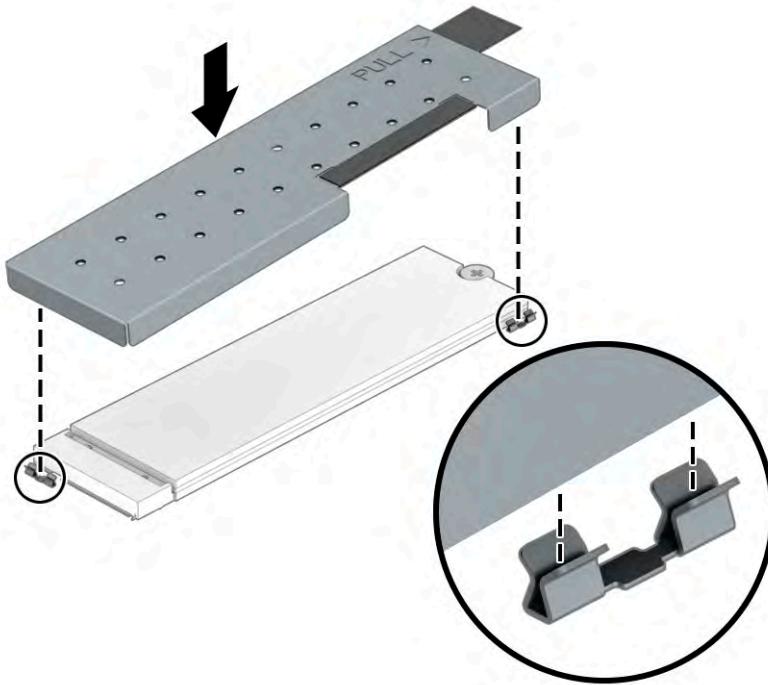

To install the solid-state drive, reverse the removal procedures.



**NOTE:** Solid-state drives are designed with a notch to prevent incorrect insertion.



---

# 6 Removal and replacement procedures for authorized service provider parts

This chapter provides removal and replacement procedures for authorized service provider parts.

 **IMPORTANT:** Components described in this chapter should be accessed only by an authorized service provider. Accessing these parts can damage the computer or void the warranty.

 **NOTE:** Details about your computer, including model, serial number, product key, and length of warranty, are on the service tag at the bottom of your computer.

---

## Component replacement procedures

To remove and replace computer components, use these procedures.

 **NOTE:** HP continually improves and changes product parts. For complete and current information about supported parts for your computer, go to <http://partsurfer.hp.com>, select your country or region, and then follow the on-screen instructions.

---

You must remove, replace, or loosen as many as 53 screws when you service the parts described in this chapter. Make special note of each screw size and location during removal and replacement.

## Preparation for disassembly

To remove and replace computer components, use these procedures.

See [Removal and replacement procedures preliminary requirements on page 28](#) for initial safety procedures.

1. Turn off the computer. If you are unsure whether the computer is off or in Hibernation, turn the computer on, and then shut it down through the operating system.
2. Disconnect the power from the computer by unplugging the power cord from the computer.
3. Disconnect all external devices from the computer.

## Battery

To remove the battery, use this procedure and illustration.

**Table 6-1 Battery description and part number**

Description	Spare part number
Battery, 3 cell, 53 Whr	L78555-005

---

 **WARNING!** To avoid personal injury and damage to the product:

- Do *not* puncture, twist, or crack the battery.
- Do *not* cause an external puncture or rupture to the battery. They can cause a short inside the battery, which can result in battery thermal runaway.
- Do *not* handle or touch the battery enclosure with sharp objects such as tweezers or pliers, which might puncture the battery.
- Do *not* compress or squeeze the battery case with tools or heavy objects stacked on top of the case. These actions can apply undue force on the battery.
- Do *not* touch the connectors with any metallic surface or object, such as metal tools, screws, or coins, which can cause shorting across the connectors.

---

Before removing the battery, follow these steps:

1. Prepare the computer for disassembly ([Preparation for disassembly on page 33](#)).
2. Remove the bottom cover ([Bottom cover on page 33](#)).

---

 **WARNING!** To reduce potential safety issues, use only the user-replaceable battery provided with the computer, a replacement battery provided by HP, or a compatible battery purchased from HP.

 **IMPORTANT:** Removing a battery that is the sole power source for the computer can cause loss of information. To prevent loss of information, save your work or shut down the computer through Windows before you remove the battery.

---

Remove the battery:

1. Lift the tape from the battery cable connector **(1)**, and then disconnect the battery cable from the system board **(2)**.
2. Remove the speaker cable from the clips along the bottom of the battery **(3)**.
3. Remove the four Phillips M2.0 × 4.0 screws **(4)** that secure the battery to the computer.

4. Remove the battery from the computer (5).

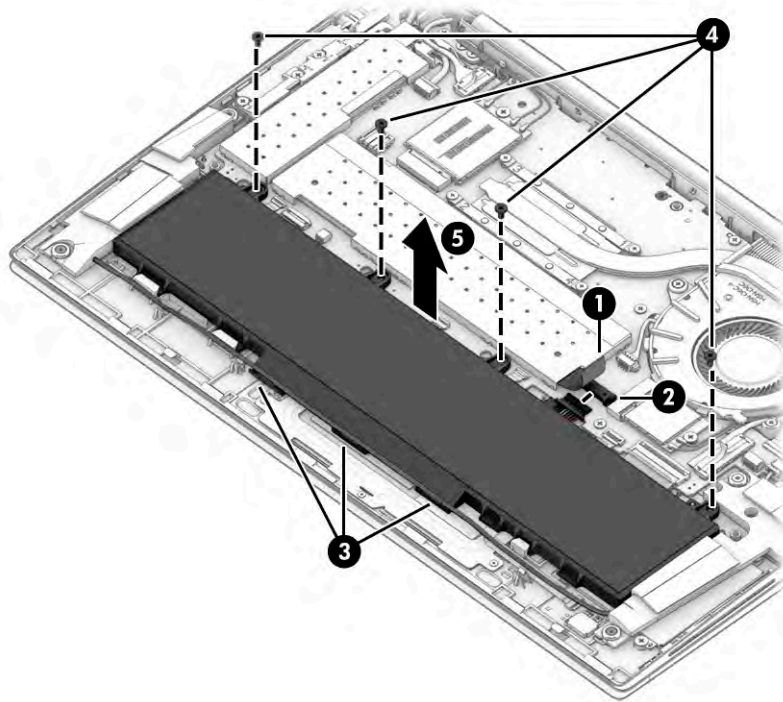

To insert the battery, reverse the removal procedures.

## RTC battery

To remove the RTC battery, use this procedure and illustration.

**Table 6-2** RTC battery description and part number

Description	Spare part number
RTC battery	L13694-001

Before removing the RTC battery, follow these steps:

1. Prepare the computer for disassembly ([Preparation for disassembly on page 33](#)).
2. Remove the bottom cover ([Bottom cover on page 33](#)).
3. Remove the battery (see [Battery on page 43](#)).

Remove the RTC battery:

1. Disconnect the battery cable from the system board (1).

2. Use a tool **(2)** to release the battery from the computer **(3)**.

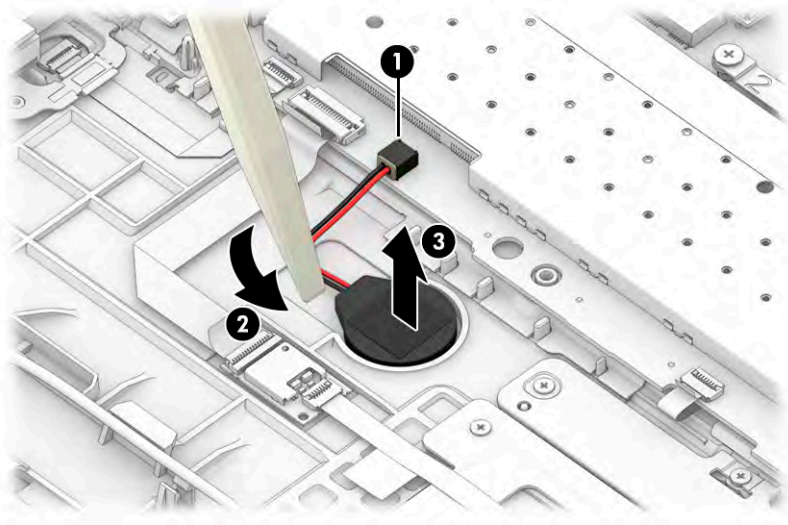

Reverse this procedure to install the RTC battery.

## Speakers

To remove the speakers, use this procedure and illustration.

**Table 6-3 Speaker description and part number**

Description	Spare part number
Speaker Kit	M07107-001

Before removing the speakers, follow these steps:

1. Prepare the computer for disassembly ([Preparation for disassembly on page 33](#)).
2. Remove the bottom cover ([Bottom cover on page 33](#)).
3. Disconnect the battery cable from the system board (see [Battery on page 43](#)).

Remove the speakers:

1. Disconnect the speaker cable from the system board **(1)**.
2. Remove the cable between the speakers from the clips along the bottom of the battery **(2)**.

3. Remove the speakers from the computer **(3)**.

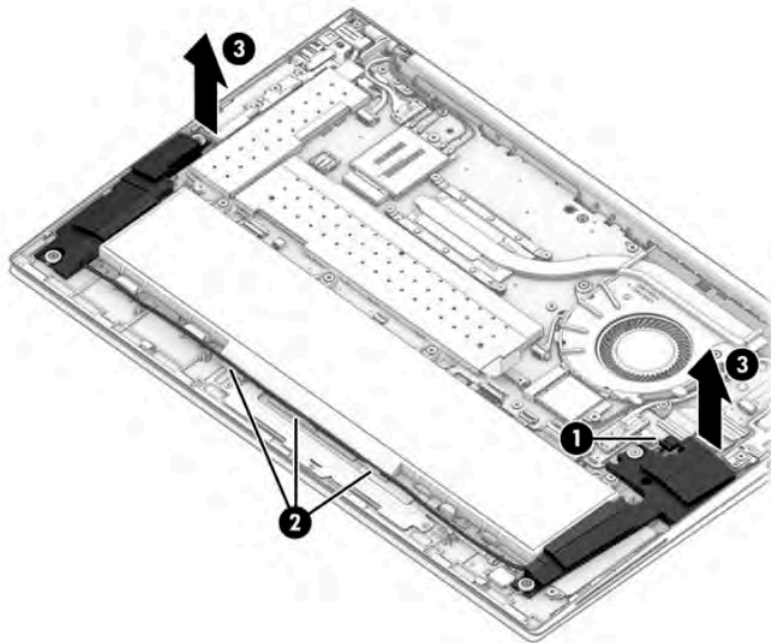

Reverse this procedure to install the speakers.

## Card reader board

To remove the card reader board, use this procedure and illustration.

**Table 6-4** Card reader board description and part number

Description	Spare part number
Card reader board	M07105-001
Card reader board cable (included in Cable Kit)	M07101-001

Before removing the card reader board, follow these steps:

1. Prepare the computer for disassembly ([Preparation for disassembly on page 33](#)).
2. Remove the bottom cover ([Bottom cover on page 33](#)).
3. Remove the battery (see [Battery on page 43](#)).
4. Remove the left speaker (see [Speakers on page 46](#)).

Remove the card reader board:

1. Disconnect the cable from the reverse ZIF connector on the card reader board **(1)**.
2. Remove the three Phillips M2.0 × 2.0 screws **(2)** that secure the board to the computer.

3. Remove the board from the computer **(3)**.

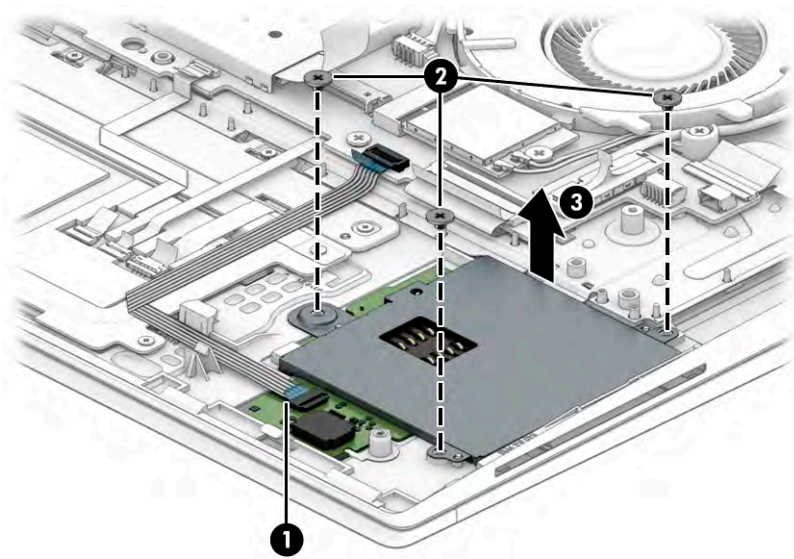

Reverse this procedure to install the card reader board.

## Power connector cable

To remove the power connector cable, use this procedure and illustration.

**Table 6-5 Power connector cable description and part number**

Description	Spare part number
Power connector cable	M15626-001

Before removing the power connector cable, follow these steps:

1. Prepare the computer for disassembly ([Preparation for disassembly on page 33](#)).
2. Remove the bottom cover ([Bottom cover on page 33](#)).
3. Disconnect the battery (see [Battery on page 43](#)).

Remove the power connector cable:

1. Disconnect the cable from the system board **(1)**, and then remove the cable from the clip.
2. Remove the Phillips M2.0 × 4.0 screw **(2)** that secures the power connector cable to the computer.

3. Remove the power connector cable from the computer **(3)**.

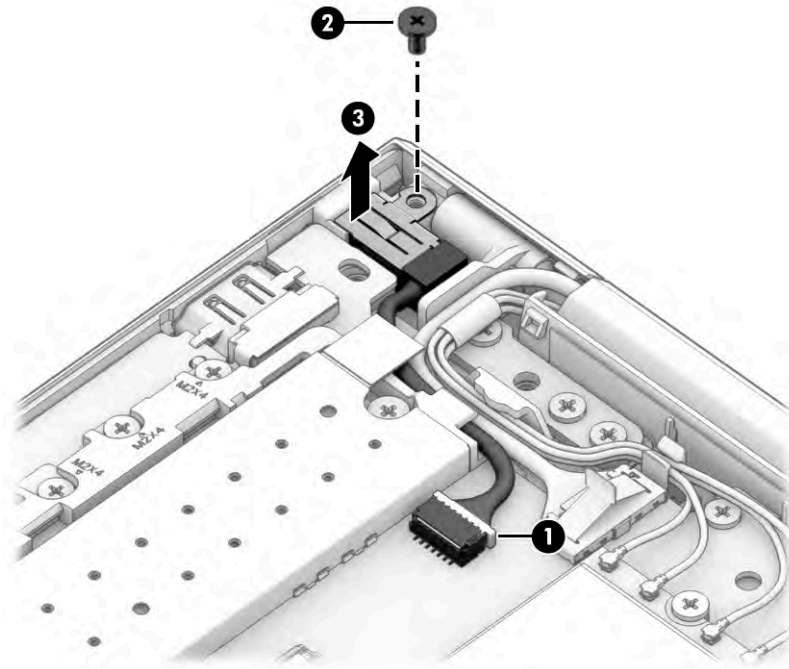

Reverse this procedure to install the power connector cable.

## USB board

To remove the USB board, use this procedure and illustration.

**Table 6-6** USB board description and part number

Description	Spare part number
USB board	M36398-001
USB board cables (included in Cable Kit)	M07101-001
USB bracket (included in Bracket Kit)	M07145-001

Before removing the USB board, follow these steps:

1. Prepare the computer for disassembly ([Preparation for disassembly on page 33](#)).
2. Remove the bottom cover ([Bottom cover on page 33](#)).
3. Disconnect the battery cable from the system board (see [Battery on page 43](#)).

Remove the USB board:

1. Disconnect the smaller cable from the USB board **(1)**.
2. Disconnect the larger cable from the ZIF connector on the USB board **(2)**.
3. Remove the three Phillips M2.0 × 4.0 screws **(3)** that secure the board to the computer, and then remove the bracket from the board **(4)**.

4. Remove the board from the computer (5).

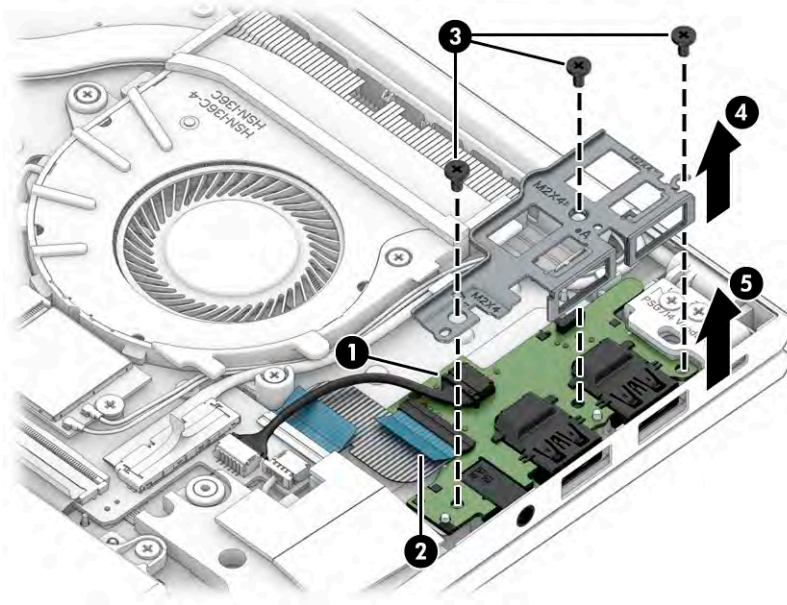

Reverse this procedure to install the USB board.

## Fingerprint reader board

To remove the fingerprint reader board, use this procedure and illustration.

**Table 6-7 Fingerprint reader board description and part number**

Description	Spare part number
Fingerprint reader board	M36444-001
Fingerprint reader board cable (included in Cable Kit)	M07101-001
Fingerprint reader board bracket (included in Bracket Kit)	M07145-001

Before removing the fingerprint reader board, follow these steps:

1. Prepare the computer for disassembly ([Preparation for disassembly on page 33](#)).
2. Remove the bottom cover ([Bottom cover on page 33](#)).
3. Remove the battery (see [Battery on page 43](#)).

Remove the fingerprint reader board:

1. Remove the Phillips M2.0 × 2.0 screw (1) that secures the fingerprint reader bracket to the computer, and then remove the bracket (2).
2. Disconnect the cable from the ZIF connector on the fingerprint reader board (3).



3. Remove the fingerprint reader board from the computer **(4)**.

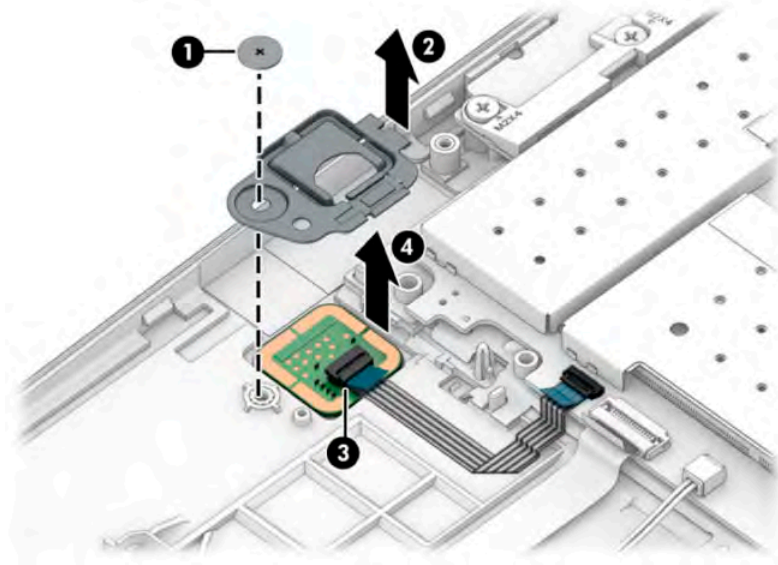

Reverse this procedure to install the fingerprint reader board.

## Touchpad

To remove the touchpad, use this procedure and illustration.

**Table 6-8 Touchpad description and part number**

Description	Spare part number
Touchpad	M42239-001
Touchpad with NFC antenna	M42240-001
Touchpad button board for use in models with UMA graphics	M07147-001
Touchpad button board for use in models with discrete graphics	M07148-001
Touchpad cable (included in Cable Kit)	M07101-001

Before removing the touchpad, follow these steps:

1. Prepare the computer for disassembly ([Preparation for disassembly on page 33](#)).
2. Remove the bottom cover ([Bottom cover on page 33](#)).
3. Remove the battery (see [Battery on page 43](#)).

Remove the touchpad:

1. Disconnect the system board cable from the ZIF connector on the touchpad **(1)**.
2. Disconnect the middle cable from the ZIF connector on the touchpad **(2)**.
3. Disconnect the touchpad button board cable from the ZIF connector on the touchpad **(3)**.
4. Disconnect the cable from the ZIF connector on the system board **(4)**.
5. Remove the four Phillips M1.6 × 1.8 screws **(5)** that secure the touchpad to the computer.

6. Lift the metal tape (6), and then remove the touchpad board from the computer (7).

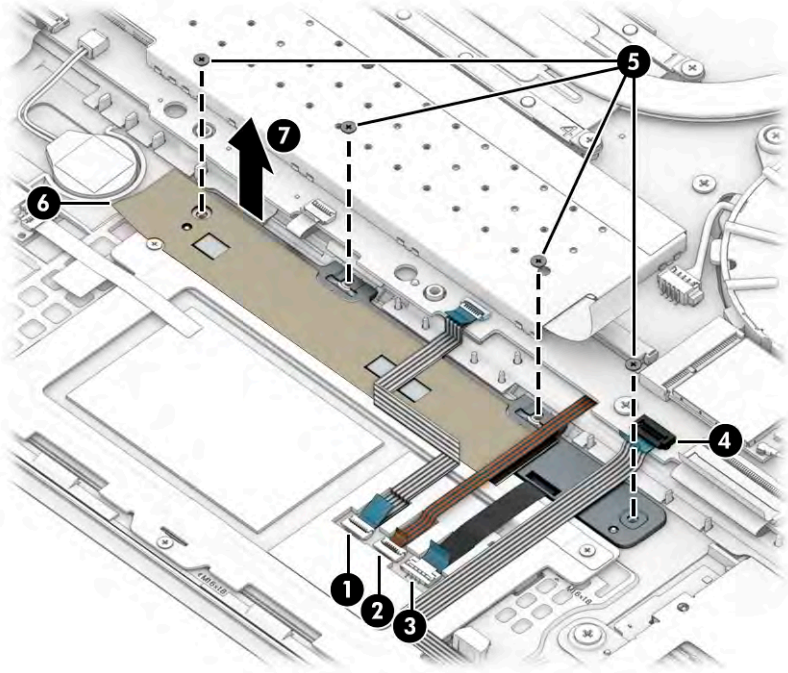

7. Disconnect the cable from the reverse ZIF connector on the NFC module (1).
8. Peel the system board cable from the side of the touchpad (2).
9. Remove the five Phillips M1.6 × 1.8 screws (3) that secure the touchpad to the computer.
10. Remove the touchpad from the computer (4).

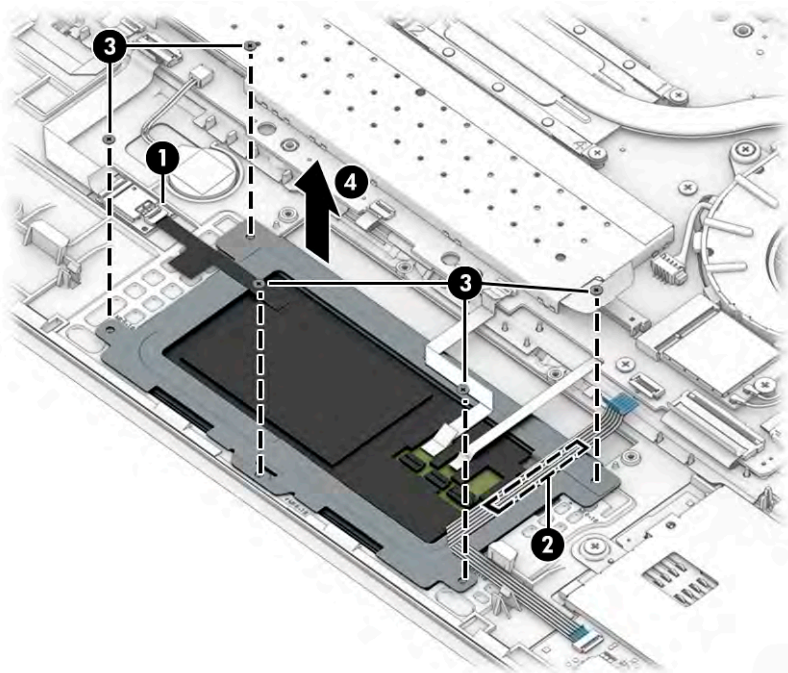

Reverse this procedure to install the touchpad.

## NFC module

To remove the NFC module, use this procedure and illustration.

**Table 6-9 NFC module description and part number**

Description	Spare part number
NFC module	M07214-001
NFC module cable (included in Cable Kit)	M07101-001

Before removing the NFC module, follow these steps:

1. Prepare the computer for disassembly ([Preparation for disassembly on page 33](#)).
2. Remove the bottom cover ([Bottom cover on page 33](#)).
3. Remove the battery (see [Battery on page 43](#)).

Remove the NFC module:

1. Disconnect the system board cable from the ZIF connector on the NFC module **(1)**.
2. Disconnect the touchpad cable from the reverse ZIF connector on the NFC module **(2)**.
3. Use a tool to release the module **(3)**, and then remove the module from the computer **(4)**. The module is secured with adhesive.

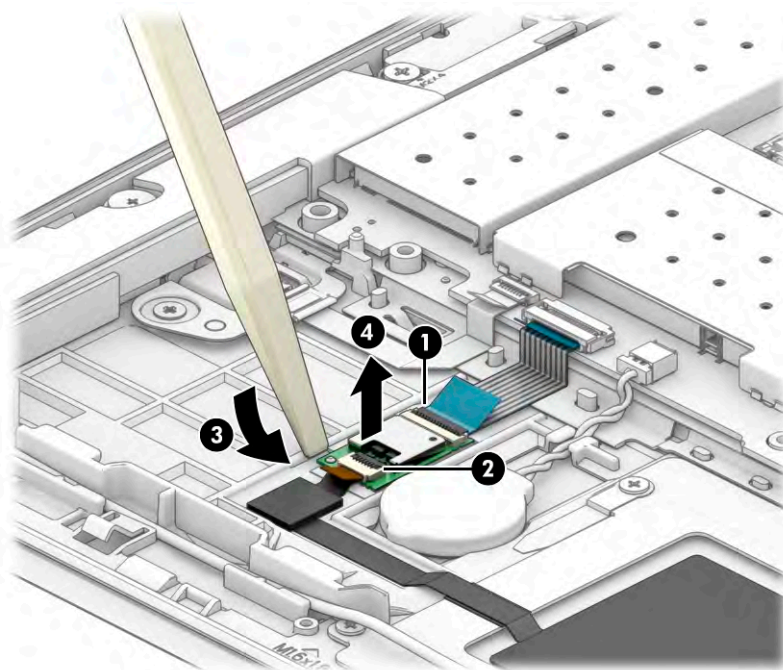

Reverse this procedure to install the NFC module.

## Fan

To remove the fan, use this procedure and illustration.

**Table 6-10 Fan description and part number**

Description	Spare part number
Fan assembly for use in models with UMA graphics memory	M07102-001
Fan assembly for use in models with discrete graphics memory	M36936-001

Before removing the fan, follow these steps:

1. Prepare the computer for disassembly ([Preparation for disassembly on page 33](#)).
2. Remove the bottom cover ([Bottom cover on page 33](#)).
3. Disconnect the battery cable from the system board (see [Battery on page 43](#)).

Remove the fan assembly:

1. Remove the cables from the clips on the side of the fan (**1**).
2. Disconnect the fan cable from the system board (**2**).
3. Loosen the three Phillips captive screws (**3**) that secure the fan to the computer, and then remove the fan from the computer (**4**).

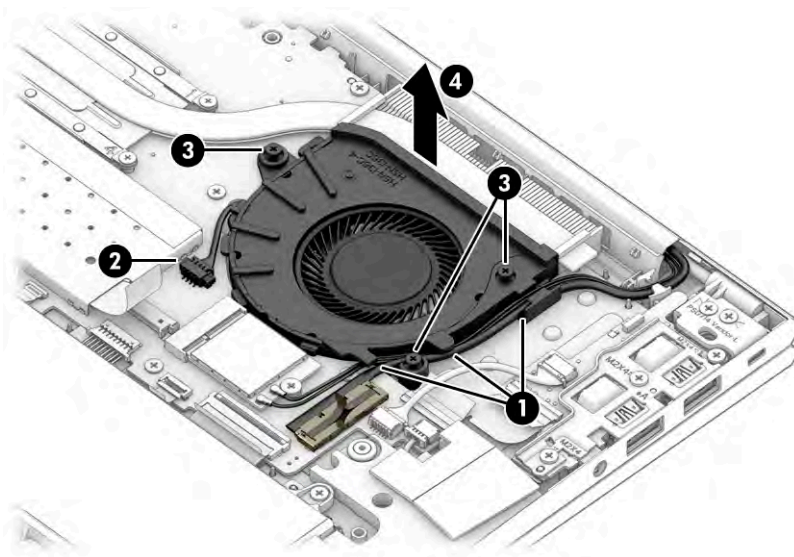

Reverse this procedure to install the fan assembly.

## Heat sink

To remove the heat sink, use these procedures and illustrations.

**Table 6-11 Heat sink descriptions and part numbers**

Description	Spare part number
Heat sink for use in models with UMA graphics memory	M07204-001
Heat sink for use in models with discrete graphics memory	M36443-001

Before removing the heat sink, follow these steps:

1. Prepare the computer for disassembly ([Preparation for disassembly on page 33](#)).
2. Remove the bottom cover ([Bottom cover on page 33](#)).
3. Disconnect the battery cable from the system board (see [Battery on page 43](#)).

Remove the heat sink:

1. To remove the heat sink on models with UMA graphics memory:
  - a. In the order indicated on the heat sink, loosen the four captive Phillips screws **(1)** that secure the heat sink to the computer.
  - b. Remove the heat sink from the computer **(2)**.

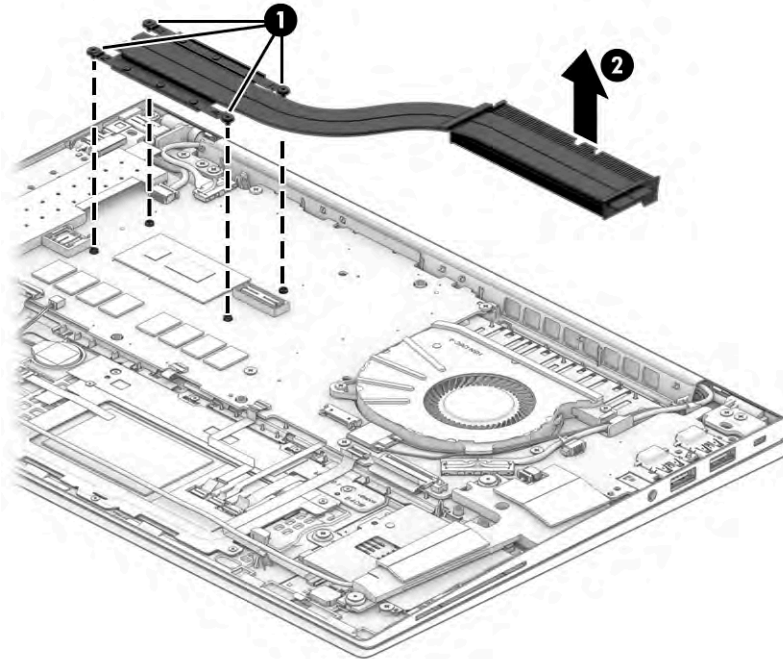

- c. Thoroughly clean the thermal material from the surfaces of the heat sink and the system board components each time the heat sink is removed. Replacement thermal material is included with the heat sink and system board spare part kits. The following illustration shows the replacement thermal material locations.

Thermal material is used on the system board component **(1)** and on the heat sink area **(2)** that services it.

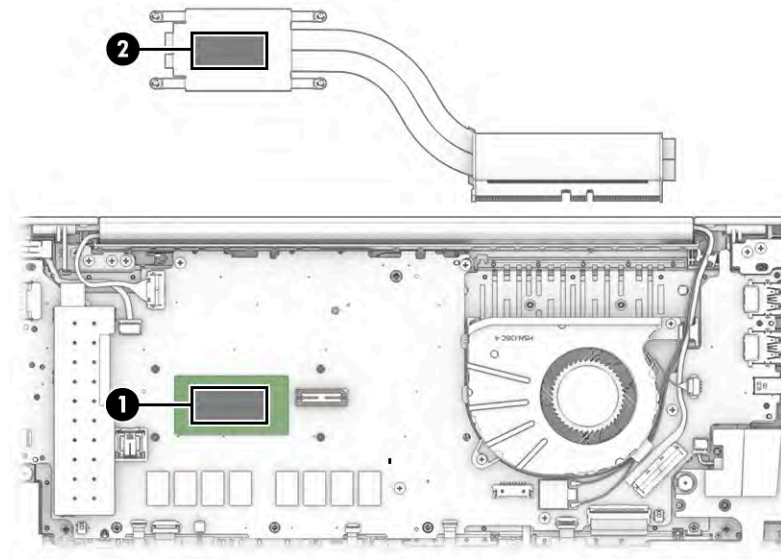

- 2. To remove the heat sink on models with discrete graphics memory:
  - a. In the order indicated on the heat sink, loosen the six captive Phillips screws **(1)** that secure the heat sink to the computer.
  - b. Remove the heat sink from the computer **(2)**.

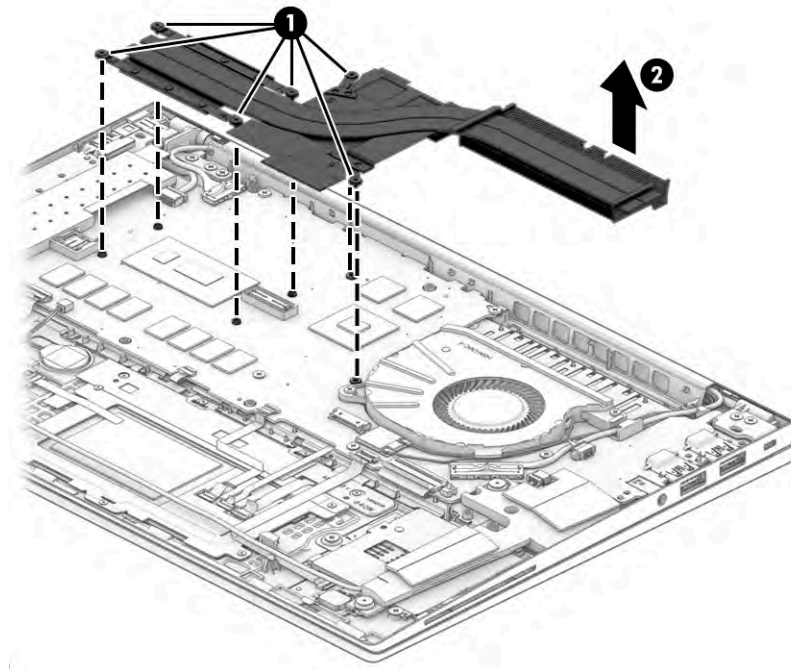

- c. Thoroughly clean the thermal material from the surfaces of the heat sink and the system board components each time the heat sink is removed. Replacement thermal material is included with the heat sink and system board spare part kits. The following illustration shows the replacement thermal material locations.

Thermal material is used on the system board components **(1) (3) (5)** and on the heat sink areas **(2) (4) (6)** that service them.

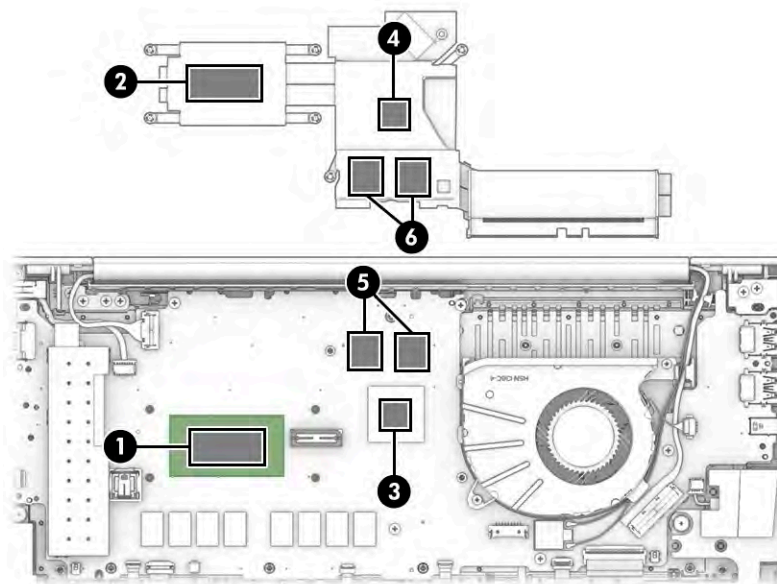

Reverse this procedure to install the heat sink.

## System board

To remove the system board, use these procedures and illustrations.

**Table 6-12 System board descriptions and part numbers**

Description	Spare part number
<b>System board</b> (includes processor):	
All system boards use the following part numbers:	
xxxxxx-001: Non-Windows operating system	
xxxxxx-601: Windows 10 operating system	
System board for use in models with UMA graphics memory:	
<ul style="list-style-type: none"> <li>Intel Core i7-1165G7</li> </ul>	M36402-xx1
<ul style="list-style-type: none"> <li>Intel Core i5-1135G7</li> </ul>	M36401-xx1
System board for use in models with discrete graphics memory:	
<ul style="list-style-type: none"> <li>Intel Core i7-1165G7 and 32 GB of system memory</li> </ul>	M36454-xx1
<ul style="list-style-type: none"> <li>Intel Core i7-1165G7 and 16 GB of system memory</li> </ul>	M36453-xx1
<ul style="list-style-type: none"> <li>Intel Core i5-1135G7 and 16 GB of system memory</li> </ul>	M36448-xx1
<ul style="list-style-type: none"> <li>Intel Core i5-1135G7 and 8 GB of system memory</li> </ul>	M36449-xx1

Before removing the system board, follow these steps:

1. Prepare the computer for disassembly ([Preparation for disassembly on page 33](#)).
2. Remove the bottom cover ([Bottom cover on page 33](#)).
3. Remove the battery (see [Battery on page 43](#)).
4. Remove the fan (see [Fan on page 53](#)).

When you replace the system board, be sure to remove the following components (as applicable) from the defective system board and install them on the replacement system board:

- Memory modules (see [Memory modules on page 34](#)).
- WLAN module (see [WLAN module on page 37](#)).
- WWAN module (see [WWAN module on page 38](#)).
- Solid-state drive (see [Solid-state drive on page 40](#)).
- Heat sink (see [Heat sink on page 54](#)).

Remove the system board:

1. Disconnect the following cables from the system board:
  - Power connector cable **(1)**
  - Camera cable **(2)**
  - Antenna cables from the WWAN module (select products only) **(3)**
  - Antenna cables from the WLAN module **(4)**
  - Larger USB cable from the USB board (ZIF) **(5)**
  - Speaker cable **(6)**
  - Small USB cable from the USB board **(7)**
  - Display cable **(8)**
  - Keyboard cable (ZIF) **(9)**
  - Card reader cable (ZIF) **(10)**
  - Touchpad cable (ZIF) **(11)**
  - Keyboard backlight cable (ZIF) (select products only) **(12)**
  - RTC battery cable **(13)**
  - NFC module cable (ZIF) (select products only) **(14)**
  - Fingerprint reader cable (ZIF) (select products only) **(15)**



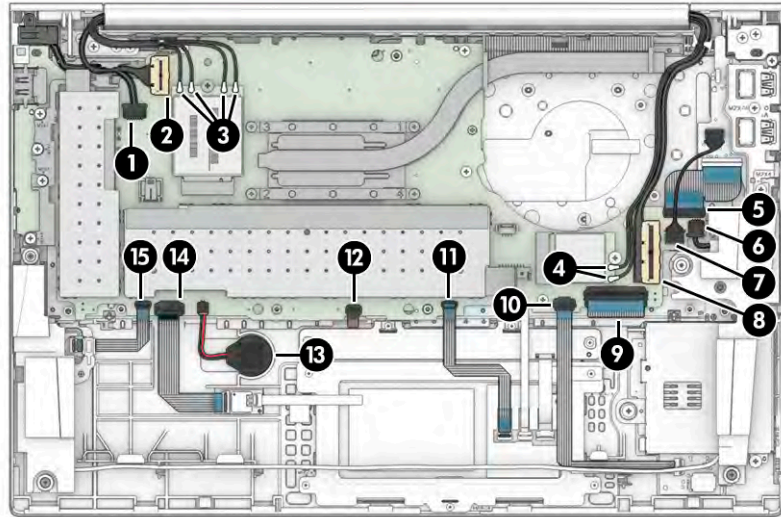

2. Remove the four Phillips M2.0 × 4.0 screws **(1)** that secure the bracket to the system board, and then remove the bracket **(2)**.

The plastic bracket is available in the Plastics Kit as spare part number M07215-001.

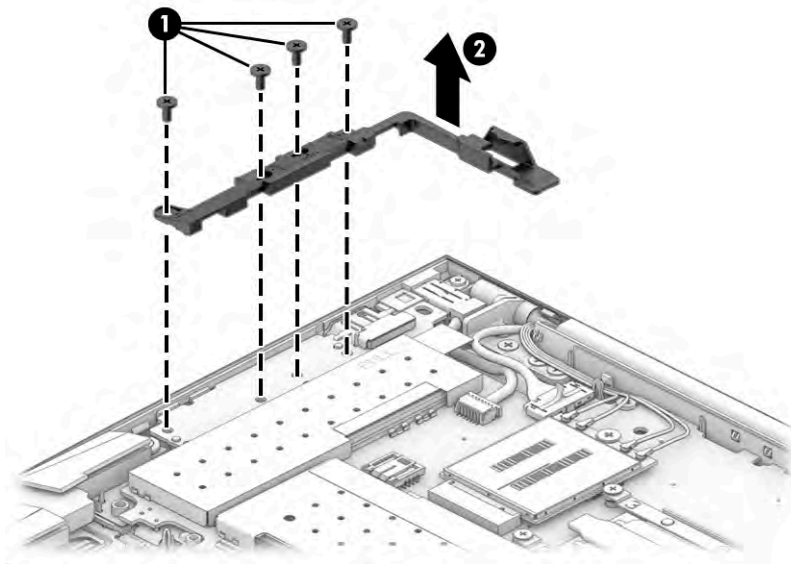

3. Remove the two Phillips M2.0 × 4.0 screws **(1)** and the three Phillips M2.0 × 2.0 screws **(2)** that secure the system board to the computer.

4. Remove the SIM card insert from the computer (3).

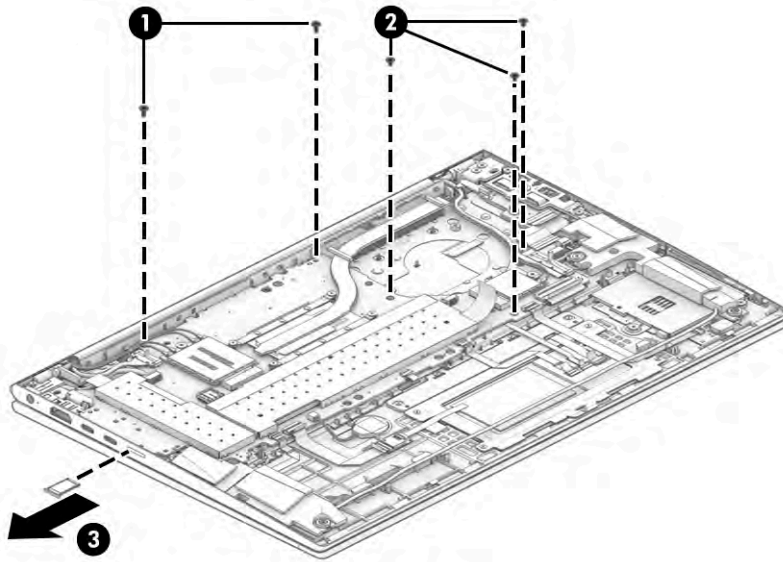

5. Lift the side of the system board upward (1), and then pull the system board away from the connectors on the side of the computer to remove it (2).

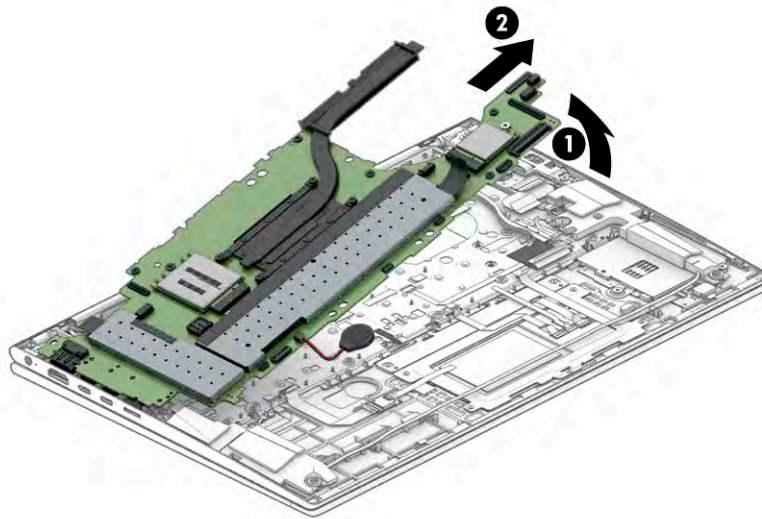

Reverse this procedure to install the system board.

## Display assembly

To remove and disassemble the display assembly, use these procedures and illustrations.

Full hinge-up displays are not available as spare parts. Spare parts for displays are available only at the subcomponent level.

Before removing the display panel, follow these steps:

1. Prepare the computer for disassembly ([Preparation for disassembly on page 33](#)).
2. Remove the bottom cover ([Bottom cover on page 33](#)).

3. Disconnect the battery cable from the system board (see [Battery on page 43](#)).
4. Remove the power connector cable ([Power connector cable on page 48](#)).

Remove the display assembly:

1. Disconnect the display cable (1) and remove it from the clip (2).
2. Disconnect the antenna cables from the WWAN module (3), and then remove the cables from the clip (4).
3. Disconnect the antenna cables from the WLAN module (5) and disconnect the left display cable (6), and then remove the cables from the clips along the side of the fan (7).

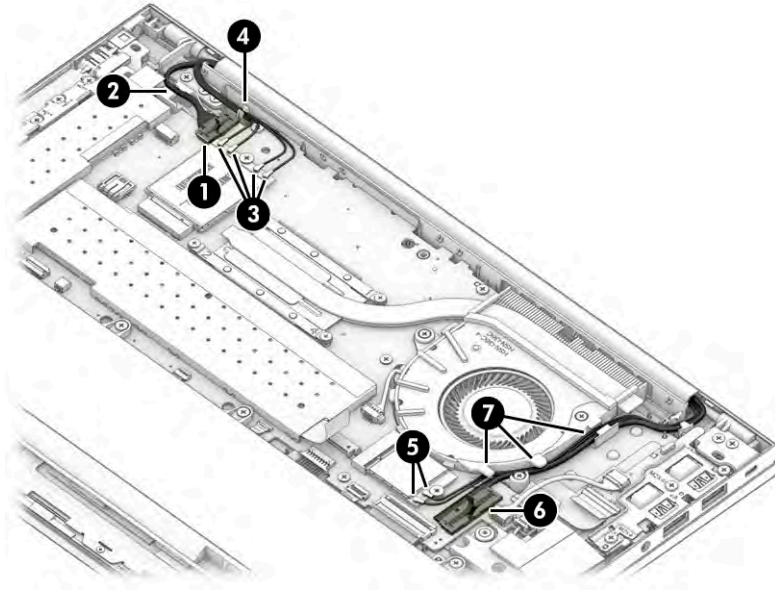

4. Remove the six Phillips M2.5 × 4.0 screws (1) that secure the display assembly to the computer.
5. Rotate the display to open the hinges (2).

6. Separate the display assembly from the computer (3).

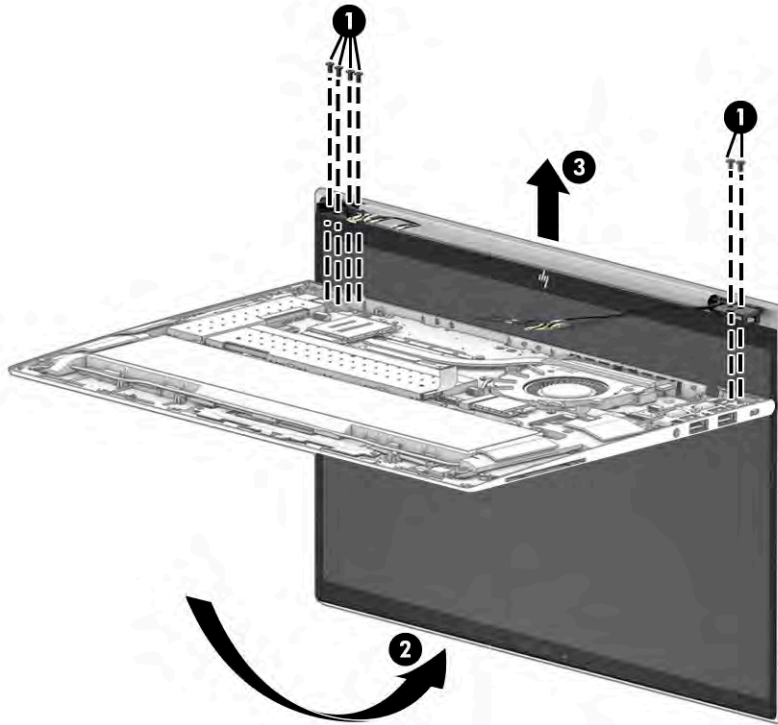

7. If you need to replace display assembly subcomponents:
- Flex the bottom (1), the left and right sides (2), and then the top of the bezel (3) to release it.
  - Remove the bezel from the display (4).

Bezels are available as the following spare part numbers:

 **NOTE:** When replacing the bezel, be sure that the replacement bezel matches the original bezel.

- M07163-001: IR camera and ambient light sensor
- M07164-001: IR camera
- M07165-001: RGB camera and ambient light sensor
- M07166-001: RGB camera
- M07100-001: Microphone module only (no camera module)

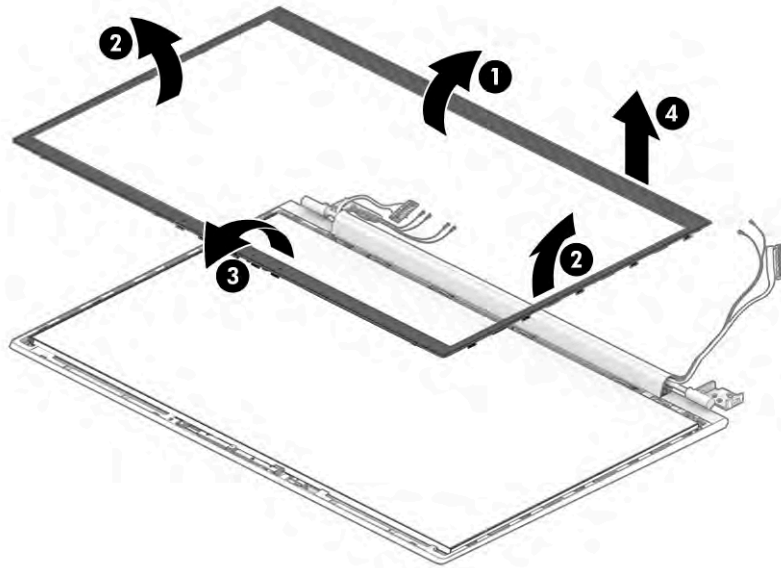

- 8.** If you need to remove the hinge cover from the display enclosure:
- a.** Remove the Phillips M1.6 × 3.0 screw **(1)** that secures the hinge cover to the display.
  - b.** Slide the hinge cover **(2)**, rotate the bottom of the cover up, and then remove it from the display **(3)**.
  - c.** Note the location of all cables hidden by the hinge cover so that you can be sure to properly route the cables during reassembly.

The hinge cover is available in the Hinge Kit as spare part number M07146-001.

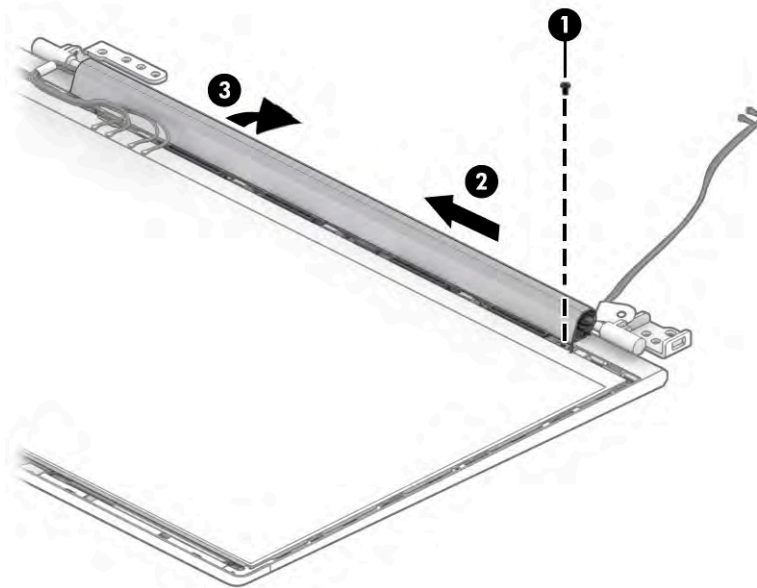

- 9.** If you need to remove the hinges from the display enclosure:
- a.** Remove the three Phillips M2.0 × 10.0 screws **(1)** from each hinge.
  - b.** Remove the hinges from the display **(2)**.

The hinges are available in the Hinge Kit as spare part number M07146-001.

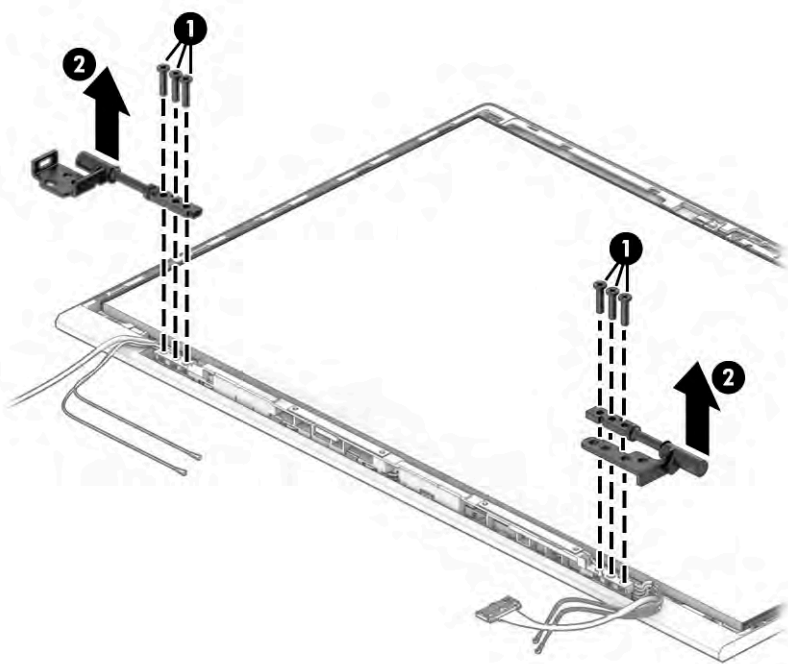

**10.** If you need to remove the display panel:

- a.** Check the fit of the various alignment tools on the display assembly. Make note of the best fitting alignment tool to use when replacing the display panel.
- b.** The display panel is secured to the display enclosure with tape that is installed under the left and right sides of the panel. To remove the panel, use tweezers to grasp the end of the tape **(1)**. While turning the tweezers, wrap the tape around the tweezers **(2)** as you continue to pull the tape out from behind the display panel **(3)**. You must pull the tape multiple times before it is completely removed.

- c. Rotate the display panel over and place it next to the display enclosure **(4)**.

Display panels are available as the following spare part numbers:

M36316-001: 1000 nit panel

M36314-001: 250 nit panel, Touch-on Panel (TOP)

M36315-001: 250 nit panel

M36313-001: 400 nit panel

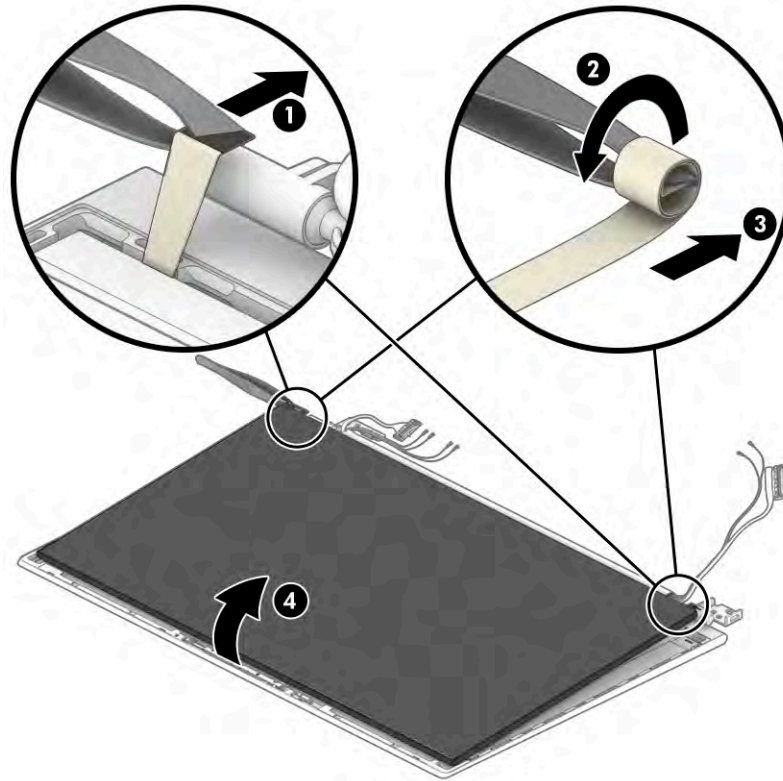

- d. Lift the tape from the connector on the display panel **(1)**, rotate the locking lever **(2)**, and then disconnect the cable from the panel **(3)**.

- e. Remove the panel **(4)**.

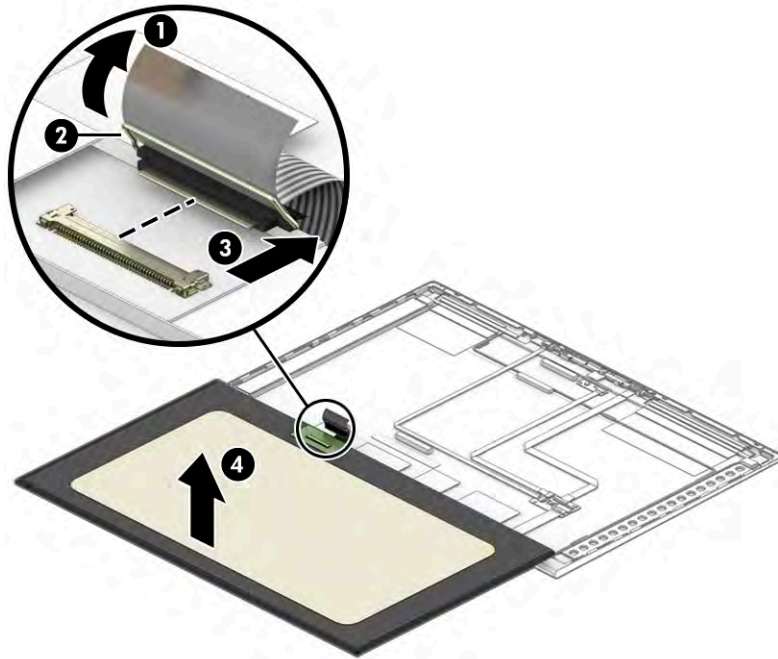

**11.** When replacing the display panel, follow these steps:

 **IMPORTANT:** Before installing the display panel, be sure to install the display cable to the back of the panel.

- a. Peel the protective layer from the bottom of the adhesive strips **(1)**.
- b. Starting near the bottom of the inside of the display back cover **(2)**, install the adhesive strips on both the left and right sides by aligning them with the groove on the edge of cover **(3)**.
- c. Peel the protective layer from the top of the adhesive strips **(4)**.
- d. Install the previously selected alignment tools onto the upper left and right corners of the display rear cover **(5)**.



- e. Insert the top of the panel into the top of the display rear cover (6), and then rotate the panel into place (7). Be sure that the upper corners of the panel are positioned up against the insides of the alignment tools.

The double-sided adhesive strips are available as spare part number M14479-001.

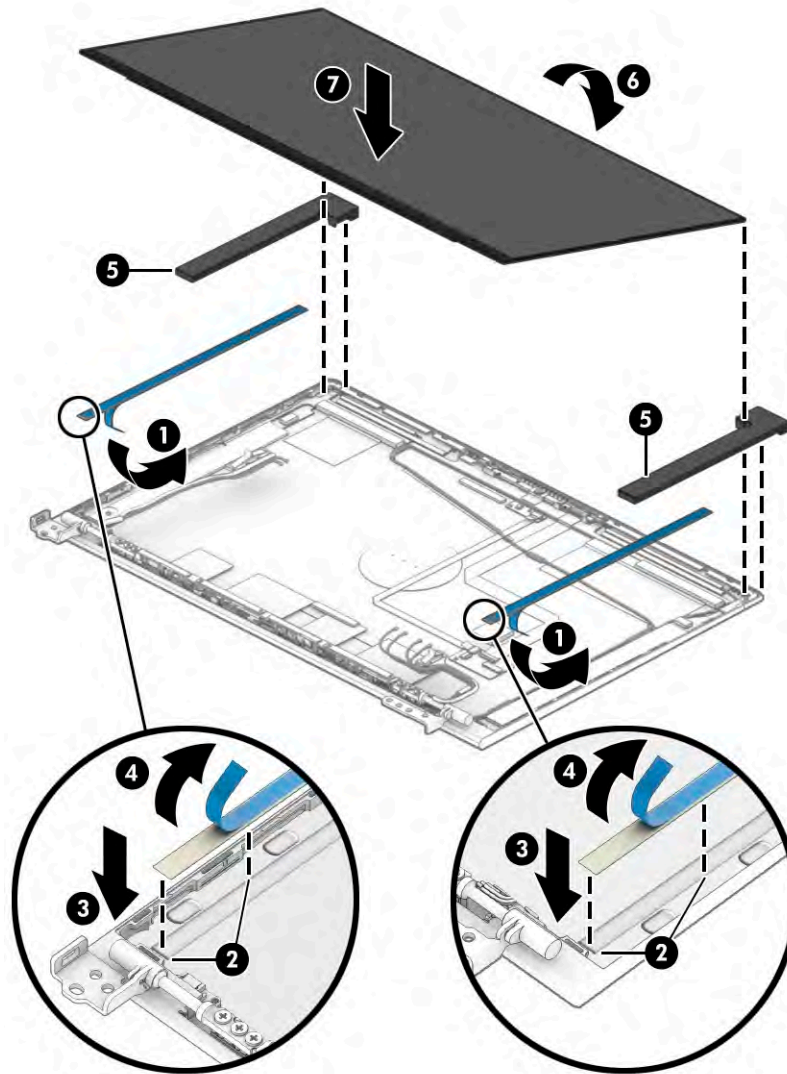

- f. Remove the alignment tool.
- g. Replace the bezel by pressing along the bottom, sides, and then top of the bezel to snap it into place.

- h.** Install temporary rubber spacer strips on the left and right sides of the bezel **(1)**, and then close the display **(2)**.

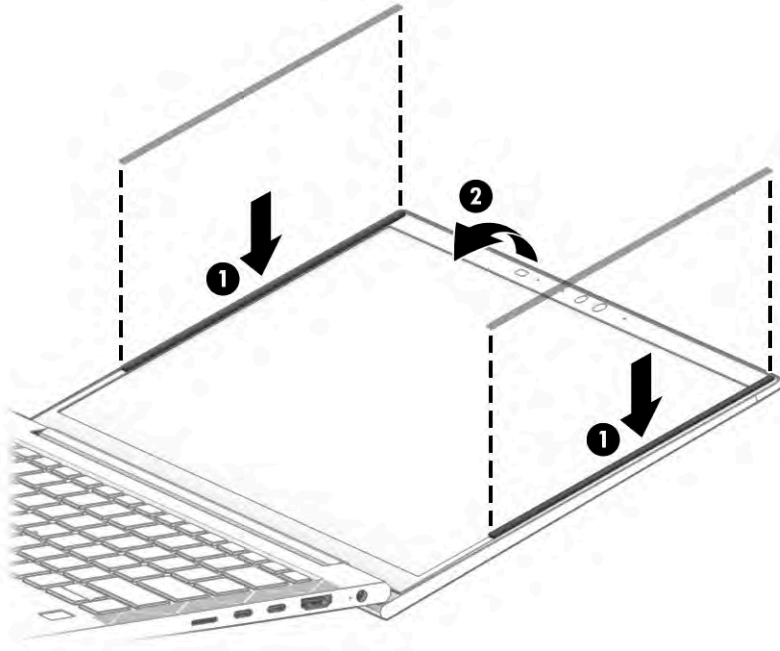

- i.** Position the computer upside down on a table.  
**j.** Leave the computer upside down on the table for 20 minutes to allow the adhesive to set.

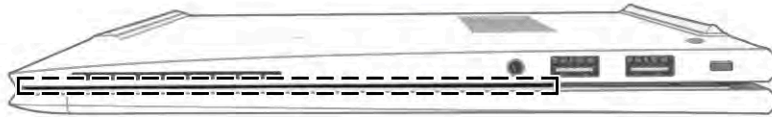

- k.** Position the computer upright on a table.  
**l.** Leave the computer upright on the table for 10 minutes to be sure that the panel sits correctly in the display.

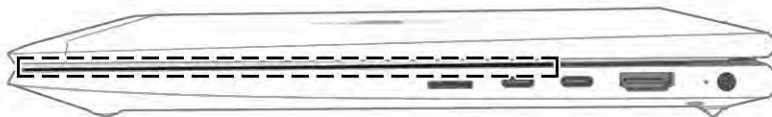

- m. Open the display and remove rubber spacer strips.
  - n. Replace the hinge cover by positioning the cover over the bottom of the display, rotating the cover upward, sliding it to the left, and then replacing the screw.
- 12.** If you need to remove the hub board from the display:
- a. Disconnect the display cable from the ZIF connector **(1)** on the hub board.
  - b. Disconnect the camera cable from the ZIF connector **(2)** on the hub board.
  - c. Disconnect the smaller cables from the reverse ZIF connectors on the hub board **(3), (4)**.
  - d. Use a tool **(5)** to release the board from the display rear cover **(6)**.

The hub board is available as spare part number M07211-001 in models with an IR camera and M07210-001 in models with an RGB camera or microphone module.

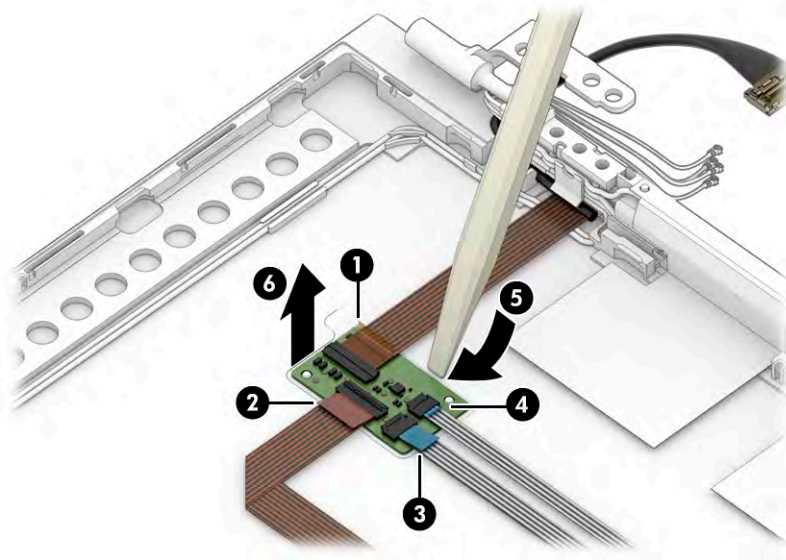

13. If you need to remove the ambient light sensor from the display, disconnect the cable from the reverse ZIF connector on the board (1), and then use a tool (2) to release the sensor from the computer (3).

The ambient light sensor is available as spare part number M07212-001.

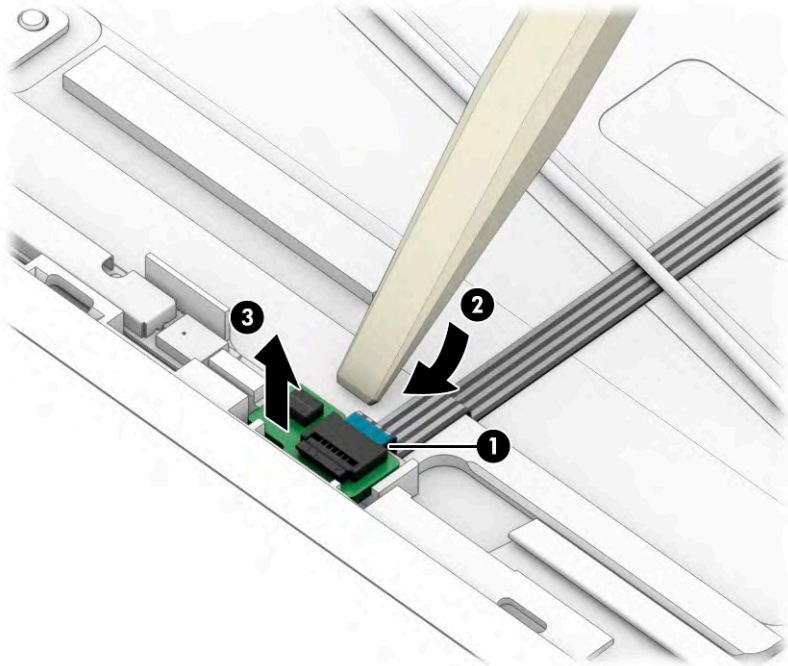

14. If you need to remove the second ambient light sensor from the display, disconnect the cables from the ZIF connectors on the board (1), and then remove the sensor from the computer (2).

The second ambient light sensor is available as spare part number M07213-001.

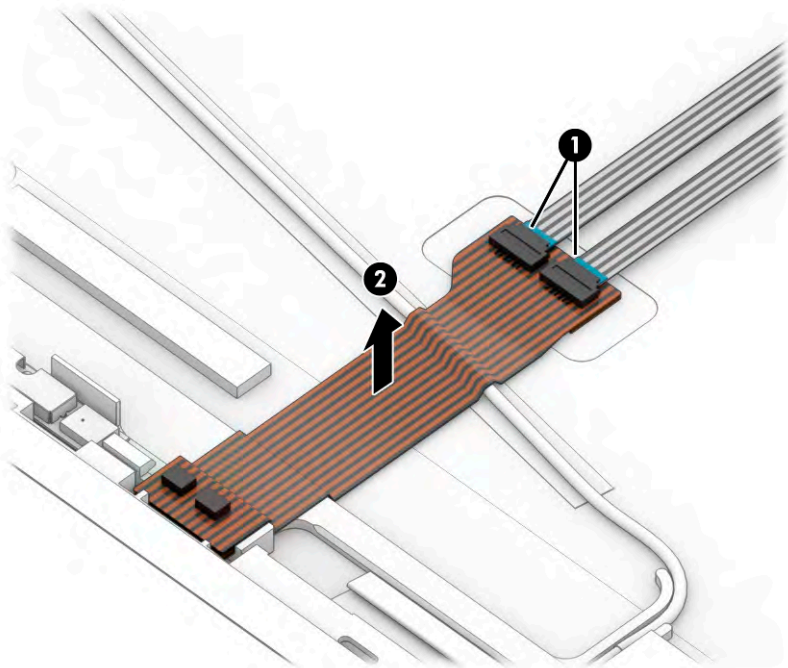

15. If you need to remove the microphone board from the display, disconnect the cable from the reverse ZIF connector on the board (1), and then use a tool (2) to release the board from the computer (3).

The microphone board is available as spare part number M07208-001 and M07209-001 for the rear-facing third microphone.

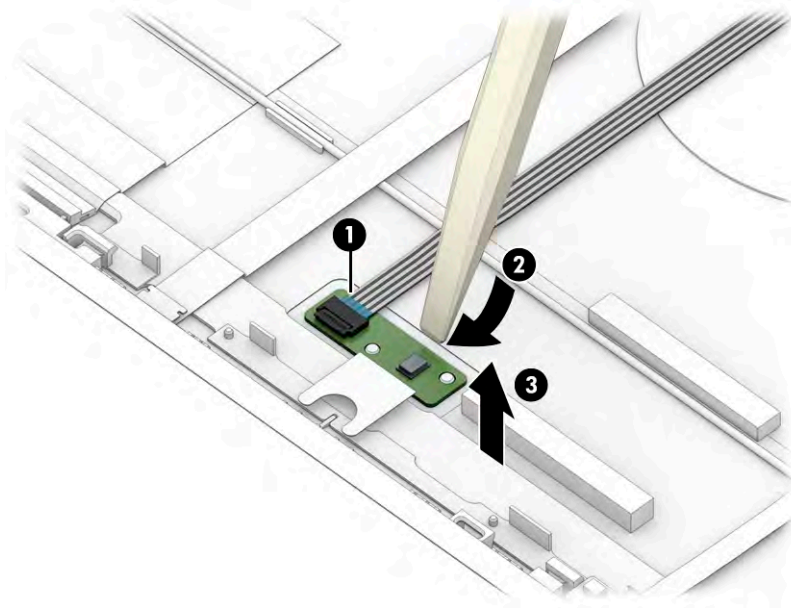

16. If you need to remove the camera module:

- ▲ Use a tool (1) to lift up evenly across the module and peel the module up from the display back cover (2), and then disconnect the cable from the reverse ZIF connector on the module (3). The camera module is available as spare part number M07216-001 for RGB cameras and M08549-001 for IR cameras.

 **NOTE:** For installation, note that the cable routes under the camera module before it connects to the module.

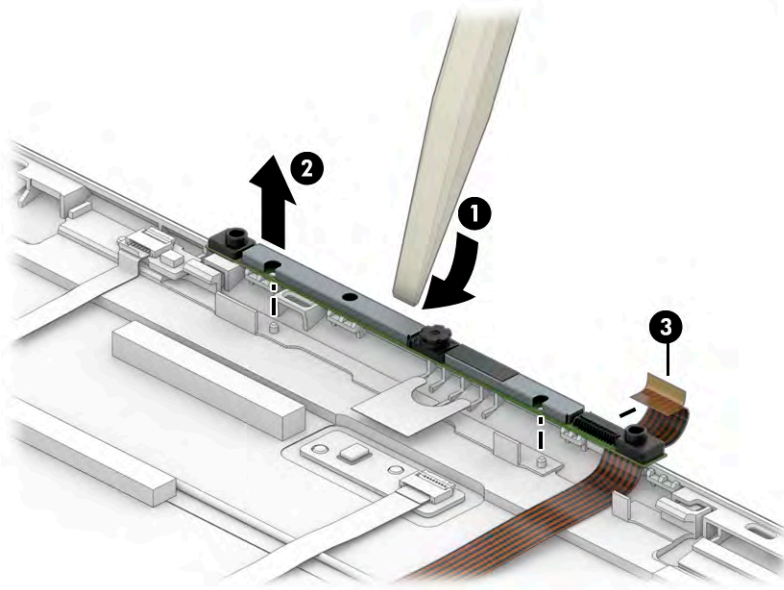

17. If you need to remove the display cable, disconnect the cable from the ZIF connector on the hub board (1), remove the cable from the clips at the bottom of the display back cover (2), and then remove the cable (3).

The display panel cable is available as spare part number M07203-001.

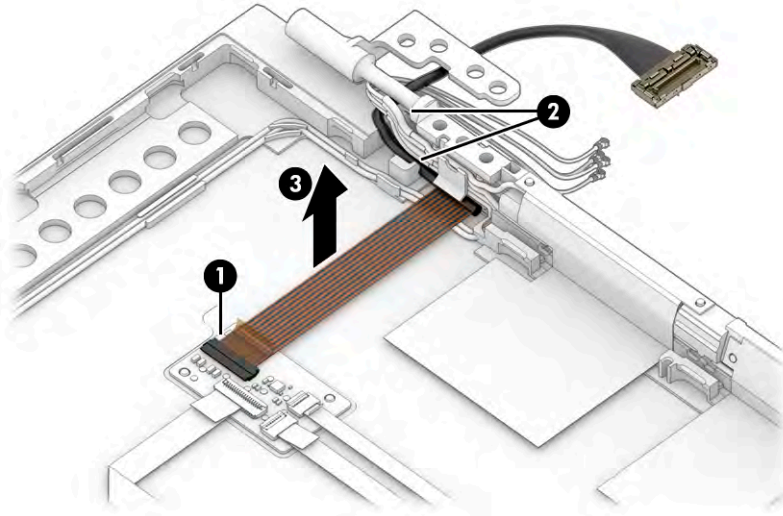

18. If you need to remove the camera cable, disconnect the cable from the ZIF connector on the hub board (1), and then peel the cable off the inside of the display back cover to remove it (2).

The camera cable is available in the Cable Kit as spare part number M07101-001.

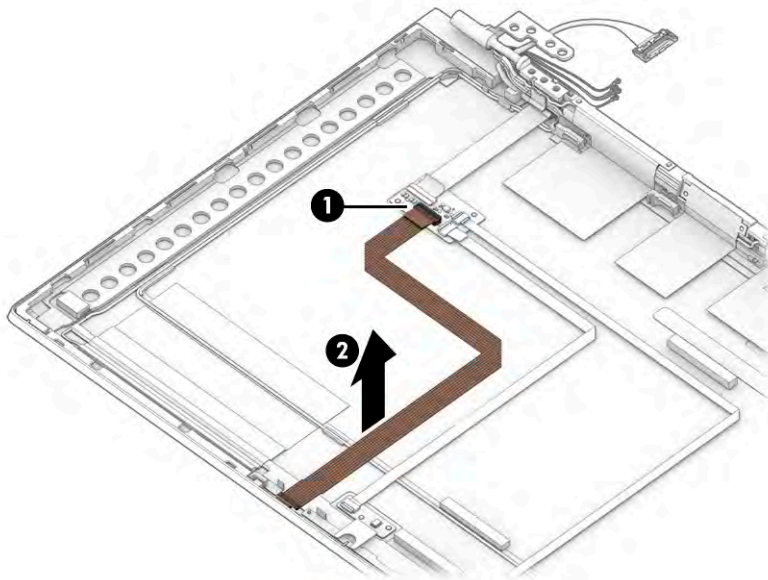

- 19.** If you need to remove the WLAN antenna cables, peel the antennas off the inside of the display back cover **(1)**, remove the cables from the clips at the bottom of the cover **(2)**, **(3)**, and then remove the antennas and cables **(4)**.

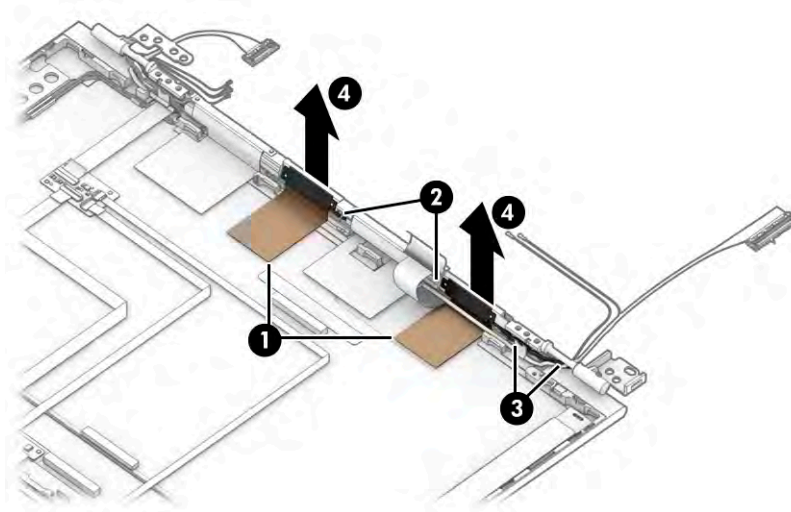

- 20.** If you need to remove the WWAN antenna cables, peel the antennas off the inside of the display back cover **(1)**, remove the cables from the clips in the back **(2)** and near the hinge on the display back cover **(3)**, and then remove the antennas and cables **(4)**.

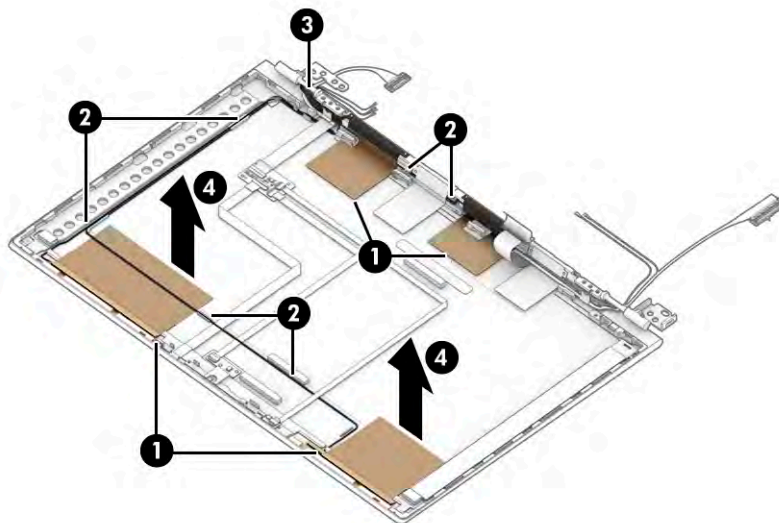

21. If you need to remove the ambient light sensor cable, disconnect the cable from the ZIF connectors on the ambient light sensor board (1) and hub board (2), and then peel the cable off the inside of the display back cover to remove it (3).

The ambient light sensor cable is available in the Cable Kit as spare part number M07101-001.

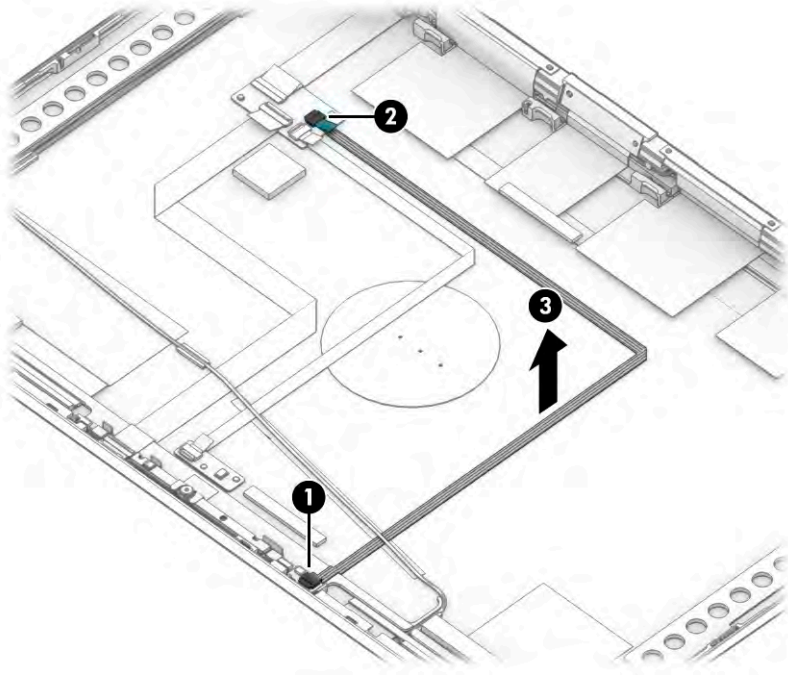



- 22.** If you need to remove the second ambient light sensor cables, disconnect the cable from the ZIF connectors on the second ambient light sensor **(1)** and hub board **(2)**, and then peel the cables off the inside of the display back cover to remove them **(3)**.

The second ambient light sensor cable is available in the Cable Kit as spare part number M07101-001.

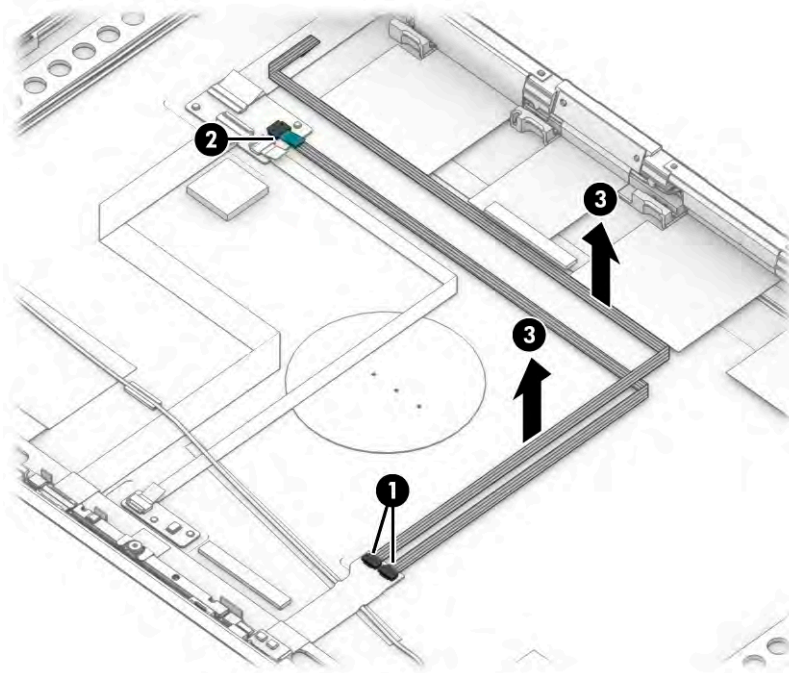

Display back covers are available as the following spare part numbers:

M36439-001: Models with WWAN, Touch-on Panel (TOP), 250 nits

M36440-001: Models with WWAN, privacy, 400 nits

M36437-001: Models without WWAN, Touch-on Panel (TOP), 250 nits

M36438-001: Models without WWAN, privacy, 400 nits

- 23.** Use the following illustration to determine proper cable routing. The WWAN antenna cables and display cable route through the right hinge **(1)**. The WLAN antenna cables and display cable route through the left hinge **(2)**.

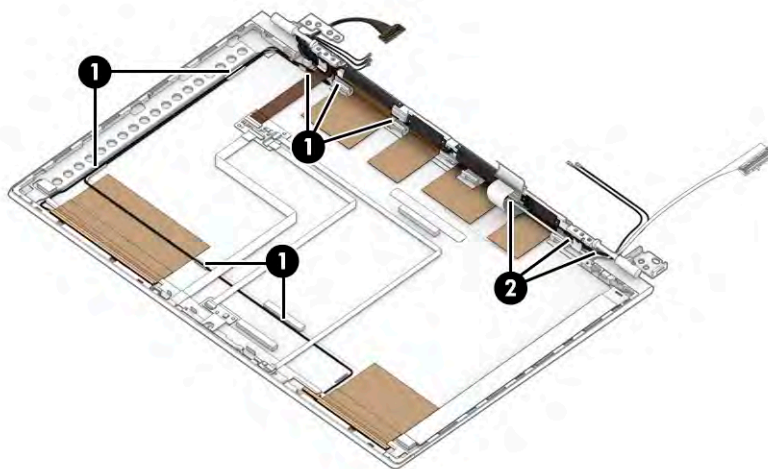

Reverse this procedure to reassemble and replace the display assembly.

## Keyboard with top cover

The top cover with keyboard remains after removing all other spare parts from the computer. In this section, the first table provides the main spare part number for the top cover/keyboards. The second table provides the country codes.

**Table 6-13 Keyboard with top cover descriptions and part numbers**

Description	Spare part number
<b>Keyboard with top cover for use in models with UMA graphics memory</b>	
Backlit	M36447-xx1
Not backlit	M36445-xx1
Backlit, for use in privacy models	M36446-xx1
<b>Keyboard with top cover for use in models with discrete graphics memory</b>	
Backlit	M44366-xx1
Not backlit	M44364-xx1
Backlit, for use in privacy models	M44365-xx1

**Table 6-14 Spare part country codes**

For use in country or region	Spare part number	For use in country or region	Spare part number	For use in country or region	Spare part number
Belgium	-A41	Hungary	-211	Saudi Arabia	-171
Brazil	-201	Iceland	-DD1	Slovenia	-BA1
Bulgaria	-261	India	-D61	South Korea	-AD1
Chile	-161	Israel	-BB1	Spain	-071
Czech Republic/Slovakia	-FL1	Italy	-061	Switzerland	-BG1
Denmark	-081	Japan	-291	Taiwan	-AB1
Denmark, Finland, and Norway	-DH1	The Netherlands	-B31	Thailand	-281
French Canada	-DB1	Northern Africa	-FP1	Turkey	-141
Finland/Sweden	-B71	Norway	-091	Turkey-F	-541
France	-051	Portugal	-131	Ukraine	-BD1
Germany	-041	Romania	-271	United Kingdom	-031
Greece	-151	Russia	-251	United States	-001

# 7 Troubleshooting guide

This chapter primarily focuses on troubleshooting HP Mobile Workstations. The information is provided so that you can solve problems yourself or at least narrow down the number of possible causes.

Based on some of the most common symptoms, this chapter identifies logical steps and available resources or tools for resolving an issue. HP recommends that you follow the instructions carefully, observe safety precautions, and note any observations or results. Capturing this information can help identify and resolve the problem more quickly.

 **WARNING!** To reduce the risk of electric shock or damage to the equipment:

- Do not disable the power cord grounding plug. The grounding plug is an important safety feature.
- Plug the power cord into a grounded (earthed) outlet that is easily accessible at all times.
- Disconnect power from the equipment by unplugging the power cord from the AC outlet.
- Before disassembling notebooks, always disconnect power and remove the battery.

 **IMPORTANT:** Static electricity can damage the electronic components of the computer. To prevent damage to the computer, carefully observe the electrostatic discharge precautions.

- Discharge static electricity by briefly touching a grounded metal object before you begin.
- Work on a static-free mat.
- Wear a static strap to ensure that any accumulated electrostatic charge is discharged from your body to the ground.
- Create a common ground for the equipment that you are working on by connecting the static-free mat, static strap, and peripheral units to that piece of equipment.
- For more information, see [Electrostatic discharge information on page 29](#).

**IMPORTANT:** The computer includes customer self-repair parts and parts that should be accessed only by an authorized service provider. Accessing parts described in the chapter titled "Removal and replacement procedures for authorized service provider only parts" can damage the computer or void the computer warranty.

## Resources

Use this table to locate troubleshooting resources.

**Table 7-1 Troubleshooting resources and their descriptions**

HP Resource Tool	Description	Link
HP Elite Support	Provides live HP Premium support (available 24/7) to Elite computers.	<a href="http://www8.hp.com/us/en/ads/elite-products/overview.html">http://www8.hp.com/us/en/ads/elite-products/overview.html</a>
HP Customer Support	Provides important support, such as warranty, support cases, drivers, Customer Advisories, Customer and Security Bulletins, and Product Change Notices.	<a href="https://support.hp.com/us-en/contact-hp">https://support.hp.com/us-en/contact-hp</a>
Subscribers Choice	Allows you to sign up for HP product updates.	<a href="http://www8.hp.com/us/en/subscribe/">http://www8.hp.com/us/en/subscribe/</a>
HP Support Forums	Provide discussions about HP products and issues.	<a href="http://h30434.www3.hp.com/psg/">http://h30434.www3.hp.com/psg/</a>

**Table 7-1 Troubleshooting resources and their descriptions (continued)**

HP Resource Tool	Description	Link
Service Access Workbench (SAW) (available for technicians and Business Partners only)	Provides navigable content intended for use by internal and outsourced call center staff and can be a resource for support and product division professionals.	<a href="http://sawpro.atlanta.hp.com/km/saw/home.do">http://sawpro.atlanta.hp.com/km/saw/home.do</a>
Vendors' web sites	Provide additional information for associated components such as Intel (processor, WLAN), Microsoft (Windows 7, 8, 10), AMD®/NVIDIA® (GPU), and so on.	<a href="http://www.intel.com/content/www/us/en/homepage.html">http://www.intel.com/content/www/us/en/homepage.html</a> <a href="http://www.amd.com">http://www.amd.com</a> <a href="http://www.nvidia.com">http://www.nvidia.com</a>

## General troubleshooting steps

This section helps you become familiar with troubleshooting methodology and efficiently resolve problems.

Proceed through the steps in the following table until the issue is resolved, and then move on to the next step that is relevant to the issue. For example, if you resolve a memory issue using the HP PC Diagnostics (UEFI) tool in step 6, you can then move on to step 10 to reseat the memory into its memory slot.



**NOTE:** You can ignore troubleshooting steps that do not apply to your issue.

**Table 7-2 Troubleshooting methodology and general troubleshooting steps**

Identify issue	Analyze issue	Resolve issue	Verify solution
<a href="#">1. Understand the issue on page 78</a>	<a href="#">5. Remove or uninstall recently added hardware, software on page 82</a>	<a href="#">8. Hard reset on page 88</a>	<a href="#">Verify solution on page 92</a>
<a href="#">2. Examine the environment on page 81</a>	<a href="#">6. HP Hardware Diagnostics and Tools on page 82</a>	<a href="#">9. Soft reset (Default Settings) on page 89</a>	
<a href="#">3. Perform a visual inspection of hardware on page 81</a>	<a href="#">7. Status lights, blinking light codes, troubleshooting lights, and POST error messages on page 85</a>	<a href="#">10. Reseat cables and connections on page 89</a>	
<a href="#">4. Update BIOS and drivers on page 81</a>		<a href="#">11. Test with minimum configuration on page 90</a>	
		<a href="#">12. Test with verified working configuration (hardware or operating system) on page 91</a>	
		<a href="#">13. Replace the system board on page 91</a>	

## Identify the issue

Use these guidelines to correctly determine the problem.

### 1. Understand the issue

It is important to understand the issue that occurred, including related symptoms. It helps to understand the basic computer boot-up sequence as well as the failure itself.

#### *Boot up sequence*

The computer performs several steps after you press the power button or restart the computer.

It is important to understand where in the boot-up sequence the symptoms occur. The following table lists the phases of the boot-up sequence and explains the symptoms that may occur in each phase. For example, a blue screen error (BSOD) often occurs during the performance phase.

**Table 7-3 Boot-up sequence and associated failures**

Item	Procedure
<b>Startup</b>	<p>After you press the power button, the computer boots after all internal power rails (such as 5 V, 3.3 V) are stable.</p> <p>Confirm that power lights are on and fan is spinning.</p> <p>Next step: If the computer experiences a startup issue, see “Verify Power Good (Troubleshooting) lights” in <a href="#">No power on page 94</a>.</p> <p>Common issues: all lights are off; troubleshooting lights are on; computer does not boot; video is absent.</p>
<b>POST (UEFI/BIOS)</b>	<p>Power-On Self-Test (POST) verifies that hardware components (such as processor, hard drive, memory) are functional. When POST is complete, the HP logo appears briefly and then disappears.</p> <p>If there are errors, the computer may exhibit blinking lights and POST error messages, and so on.</p> <p>Common issues: lights blink; error message appears; system hangs (lock up or freezes)</p>
<b>Performance (operating system)</b>	<p>System boots to operating system, and Windows logo screen appears.</p> <p>Common issues: hangs, blue screen, distorted video, driver conflict, slow performance, display issue (dead pixel), I/O issue (no speaker sound), wireless/audio unavailable, noise.</p> <p>See <a href="#">Analyze the issue on page 82</a> table for detailed troubleshooting information.</p>

## Failure classification

*Failure classification* is a breakdown of different types of failures and symptoms that could occur during the boot-up sequence.

[Failure classification by boot-up sequence on page 80](#) and [Failure classification by hardware devices on page 80](#) represent the failure classification for common notebook failures.

[Failure classification by boot-up sequence on page 80](#) categorizes failures by the boot-up sequence.

1. Power-on: Common issues are no power, recycle, or reboot.
2. POST: Common issues are no boot (despite power), light flash, or diagnostics error.
3. Performance: Common issues are Intermittent Loss of Power, Blue Screen, Hang. In many cases, issues can be identified and associated with particular hardware (for example, display or storage).

[Failure classification by hardware devices on page 80](#) categorizes failures by hardware:

- Display
- I/O (input/output) devices
- Storage
- Mechanical

A single symptom can be listed under different groups. For example, No Video can belong to (1) power-on or (4) display; but flickering when turned on should be listed in (4) display. Or, in another example, a blue screen can be caused by a driver conflict in performance (4), but it can also be caused by a defective hard drive under (6) storage. Therefore, failures that share similar symptoms are noted.

If possible, make a record of the failure symptom, the phase of the boot-up sequence where the failure occurs, and the most likely location in the failure tree ([Failure classification by boot-up sequence on page 80](#) and [Failure classification by hardware devices on page 80](#)). This record helps isolate the issue and indicate the next steps. For example, when the computer is running the operating system, it can experience an issue with (4) display, (5) I/O devices (keyboard, wireless, and so on), (6) storage, or (7) mechanical components (stuck buttons, thermal shutdown, and so on).



**NOTE:** *Uncategorized* is used if an issue found is not listed. For example, Bluetooth is offered on certain hardware configurations; therefore, you can classify a Bluetooth issue under I/O Device if needed.

## Failure classification by boot-up sequence

Use this table to locate failure classification information.

**Table 7-4 Failure classification by boot-up sequence**

1. Power-on	2. POST	3. Performance
1. <a href="#">No power on page 94</a>	1. <a href="#">No video (with power) on page 100</a>	1. <a href="#">Intermittent shutdown on page 103<sup>a</sup></a>
2. <a href="#">Intermittent power-on, shutdown, reboot on page 96<sup>a</sup></a>	2. <a href="#">Blinking lights on page 102</a>	2. <a href="#">Blue screen on page 105<sup>b</sup></a>
3. <a href="#">AC adapter issue on page 97</a>	3. <a href="#">Diagnostic error messages on page 102</a>	3. <a href="#">Freeze at Windows Logo (hang or lockup) on page 105</a>
4. <a href="#">Battery not recognized, not charging on page 98</a>	4. <a href="#">BIOS password on page 103</a>	4. <a href="#">Electromagnetic Interference (EMI) on page 106</a>
5. <a href="#">Battery discharges too fast on page 99</a>		5. <a href="#">No wake up on page 106</a>
6. <a href="#">Burnt smell on page 100</a>		6. <a href="#">Unresponsive on page 107</a>
		7. <a href="#">Slow performance on page 108<sup>c</sup></a>
		8. <a href="#">HP Smart Adapter warning message on page 108</a>
		9. <a href="#">Incorrect time and date on page 109</a>

<sup>a,b,c</sup> similar symptoms

## Failure classification by hardware devices

To determine failure by device, use this table.

**Table 7-5 Failure classification by hardware devices**

4. Display	5. I/O devices	6. Storage	7. Mechanical
1. <a href="#">Display anomalies on page 109</a>	1. <a href="#">Keyboard on page 115</a>	1. <a href="#">Hard drive or solid-state drive not recognized on page 124</a>	1. <a href="#">Noise (sound) on page 127</a>
2. <a href="#">Dead pixel on page 111</a>	2. <a href="#">Keyboard pointing stick (select products only) on page 116</a>	2. <a href="#">No boot to operating system (no read-write error) on page 125</a>	2. <a href="#">Fan runs constantly on page 128</a>
3. <a href="#">No video (internal) on page 112<sup>d</sup></a>	3. <a href="#">Keyboard backlight on page 117</a>	3. <a href="#">Read-write error on page 125</a>	3. <a href="#">Thermal shutdown (hot) on page 129</a>
4. <a href="#">No video (external) on page 112<sup>d</sup></a>	4. <a href="#">Touchpad on page 117</a>	4. <a href="#">Slow performance on page 108<sup>c</sup></a>	4. <a href="#">Malfunctioning power button on page 130</a>
5. <a href="#">DisplayPort/VGA on page 112</a>	5. <a href="#">Network connectivity (RJ-45 jack) on page 118</a>	5. <a href="#">Blue screen (BSOD) error on page 126<sup>b</sup></a>	
6. <a href="#">HDMI on page 113</a>			

**Table 7-5 Failure classification by hardware devices (continued)**

4. Display	5. I/O devices	6. Storage	7. Mechanical
7. <a href="#">No or bad external video via docking on page 113</a>	6. <a href="#">Network connectivity wireless (WLAN) on page 118</a>	6. <a href="#">Noisy hard drive on page 126</a>	
8. <a href="#">Incorrect or missing color/distorted image on page 114</a>	7. <a href="#">WWAN on page 119</a>		
9. <a href="#">Touch screen on page 114</a>	8. <a href="#">USB on page 119</a>		
	9. <a href="#">Smart card reader on page 120</a>		
	10. <a href="#">Speaker, headphone - audio issues on page 121</a>		
	11. <a href="#">Thunderbolt (TB) on page 122</a>		

<sup>b,c,d</sup> similar symptoms

## 2. Examine the environment

It is important to examine the computer's environment. If you can quickly identify the cause of the issue, fewer resolution steps might be needed. Perform the following environment inspections:

- Check all cables and connections to be sure that no connections are loose.
- Confirm that power sources are good, such as AC outlet or adapter (110 V/220 V ac), power strip. Test with a verified working AC outlet.
- Check for compatibility issues between the computer and third-party devices, peripherals, uncertified devices, incompatible hardware (for instance, Mac OS device). Incompatibility can result in blue screen errors, improper operation, and so on.
- Isolate the computer from sources of electromagnetic interference (EMI), such as cell phones, two-way radios, floor mats, fans (and other electronic motors). EMI may contribute to a display freeze issue or lock-up.

## 3. Perform a visual inspection of hardware

Perform a physical inspection of the computer.

- Look for abnormalities such as a cracked display, dented battery, broken latches for battery bay, keyboard key caps popped out, dust over connectors, liquid spill over keyboard.
- Look for signs of drop, movement, or vibration that may cause internal and external loose connections.

## 4. Update BIOS and drivers

Whenever possible, update to the latest BIOS, firmware, and drivers before troubleshooting.



**IMPORTANT:** Note that some customer company policies prohibit updates. Check your company policy before taking action.

The updates may include fixes for your computer issues, and they may also enhance system performance. HP continually improves the update process to make it easier. You can update the BIOS locally through a manual process, through an automatic installation, or through a remote installation on multiple units.

## Manually updating BIOS and drivers

Use this information to update the BIOS.

- To manually update the BIOS and drivers, see the Setup Utility (BIOS) chapter.
- See the specific BIOS update installation instructions that accompany the download.

## Remotely deploying the BIOS and drivers

Instead of manually searching for and downloading each SoftPaq, users and IT personnel can use two tools to identify and download all appropriate SoftPaqs for the selected HP models.

- HP SoftPaq Download Manager (SDM) is a software tool that streamlines the download, extraction, and installation process of SoftPaqs, including BIOS and drivers.
- HP System Software Manager (SSM) is a software tool that simplifies the deployment of SoftPaqs to HP computers.

## Analyze the issue

Use these steps to evaluate and interpret the problem.

### 5. Remove or uninstall recently added hardware, software

HP has designed this computer and validated it using a full-range hardware and software qualification matrix. If an issue appears to have started recently, it may be related to the recent addition of hardware or software.

A good method to determine the root cause is to remove recently added components or uninstall applications one at a time and restart the computer when necessary.



**IMPORTANT:** After you have completed the process of uninstalling hardware or software and are ready to reinstall, be sure that the new device is seated properly and all cables are correctly connected. After installing the device, restart the computer, and be sure that the new device is turned on. In addition, if the new device is a root cause of a problem, it could cause a conflict in drivers or incompatibility issues with other installed programs. For any new hardware you have added, be sure to install the latest drivers available from the device vendor website.

### 6. HP Hardware Diagnostics and Tools

HP offers diagnostics and tools to diagnose hardware failure. This section describes how to use some of these tools. Make sure to check for the latest versions before use.

#### HP PC Hardware Diagnostics (UEFI)

HP PC Hardware Diagnostics is a Unified Extensible Firmware Interface (UEFI) that allows you to run diagnostic tests to determine whether the computer hardware is functioning properly.

The HP PC Hardware Diagnostics (UEFI) tool is built within BIOS (basic memory and hard drive diagnostics only), or within new hard drives themselves. These drives contain more advanced versions of the diagnostic tool than the BIOS-based version.

In addition, for HP authorized service partners and IT professionals who need to support a mixed environment of older and newer HP/Compaq PCs, the HP PC Hardware Diagnostics Tool ([http://www8.hp.com/us/en/campaigns/hpsupportassistant/pc-diags.html?jumpid=va\\_r602\\_us/en/any/pps/pl\\_ot\\_ob\\_ds\\_pd/HP\\_PC\\_Hardware\\_Diagnostics\\_cc/dt](http://www8.hp.com/us/en/campaigns/hpsupportassistant/pc-diags.html?jumpid=va_r602_us/en/any/pps/pl_ot_ob_ds_pd/HP_PC_Hardware_Diagnostics_cc/dt)) supports a wide range of HP computers.

The tool runs outside the operating system so that it can isolate hardware failures from software issues, whether caused by the operating system or applications. In reality, you can determine many problems using



this tool if the issue is a defective part or a loose connection (for example, reseating the keyboard cable after the tool reports a keyboard error).

The tool has three major functions:

- System Tests check the computer's hardware to verify that everything is functioning properly. If your system won't boot into Windows, try the Quick System Test. For more comprehensive testing, use the Extensive System Test option. If the System Test did not detect a hardware problem, continue with the Component Tests.
  - Component Tests focus on selected hardware components in your computer.
  - Firmware Management update your computer's BIOS to the latest version (available separately) or rolls back to a previous version.
1. Turn on or restart the computer, quickly press the **esc** key on the computer, and then press **f2**. The BIOS searches three places for the diagnostic tools, in the following order:
    - 1. Connected USB drive
    - 2. Hard drive
    - 3. BIOS

2. When the diagnostic tool opens, use the keyboard arrow keys to select the type of diagnostic test you want to run, and then follow the on-screen instructions.

Screen capture appearance may vary.

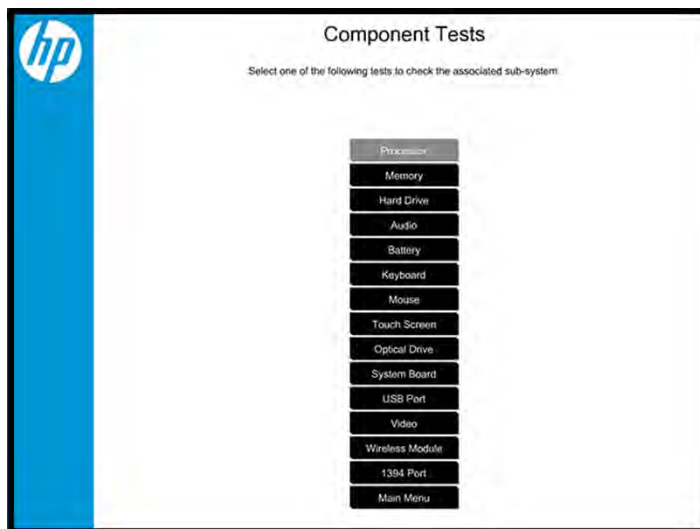
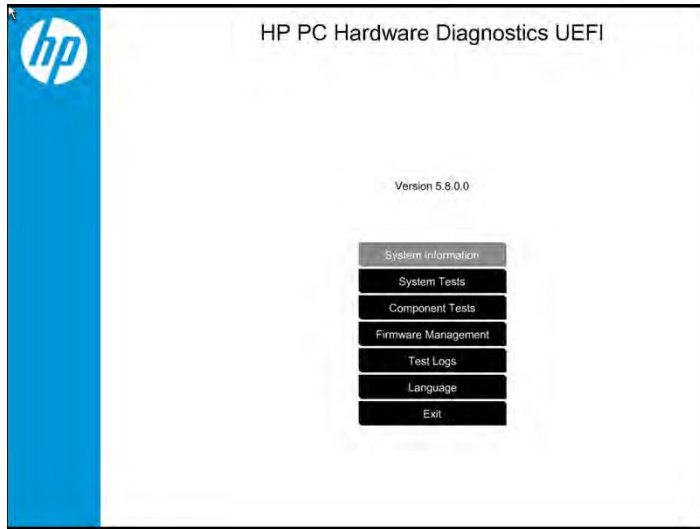

---

 **NOTE:** Use this tool, especially when the computer cannot boot to Windows.

 **NOTE:** If a component fails a test, write down the information so that it is available when you contact support. The information is also available in **Test Logs** on the Main Menu.

---

For more information, see [Using HP PC Hardware Diagnostics on page 152](#)

### HP BIOS Configuration Utility (BCU)

HP BCU is a free utility that captures the BIOS settings and their values. This tool provides a text file of the computer's BIOS configuration. This file can help identify any settings that may be contributing to an issue.

In some cases, it may help to compare this BIOS text file to the default settings of the computer.

For more information, see the [http://ftp.hp.com/pub/caps-softpaq/cmit/whitepapers/BIOS\\_Configuration\\_UTILITY\\_User\\_Guide.pdf](http://ftp.hp.com/pub/caps-softpaq/cmit/whitepapers/BIOS_Configuration_UTILITY_User_Guide.pdf).



**NOTE:** HP recommends that you reset BIOS before trying BCU. Resetting the BIOS is always available and relatively quick to try, whereas BCU takes extra time and effort.

### HP Image Diagnostic Tool

Available to HP Authorized Support Partners (ASPs) and users, this tool collects information about the current state of the computer, including product serial number, platform and BIOS information, and information about user-installed software and hardware components.

Access this tool at <ftp://ftp.hp.com/pub/idr/ImageDiags/>. HP encourages you to review the report before sending it to support. The report may assist you with diagnostics and solutions to problems you encounter.

### HP Thermal Monitor

You can use HP Thermal Monitor to stress the processor and GPU and monitor the temperature values of various components in the system.



**NOTE:** Available only to authorized service providers and technicians.

The components that are currently monitored include the processor, GPU, ACPI thermal zones, hard drive, and battery. The tool reads the temperatures of the components, logs the data, and helps to determine whether the computer would overheat in the event of thermal shutdown, fan spinning loud, and so on.

### Non HP diagnostics tools

Refer to the following diagnostic tools for troubleshooting help.

#### *Windows-to-Go USB*

Windows-To-Go USB is a Microsoft-based tool for Enterprise editions of Windows that can help in troubleshooting. You can find a process online about how to create a live Windows USB drive. For more information, see <https://technet.microsoft.com/en-us/library/hh831833.aspx>.

#### *Intel Processor Diagnostic Tool*

Determine what processor is in your computer and verify the processor operating frequency. The tool also tests specific processor features and performs a stress test on the processor. For more information, see [http://www.intel.com/support/processors/sb/CS-031726.htm?iid=subhdr+tools\\_procdiagtool](http://www.intel.com/support/processors/sb/CS-031726.htm?iid=subhdr+tools_procdiagtool).

## 7. Status lights, blinking light codes, troubleshooting lights, and POST error messages

Carefully observe any behavior that the computer may be exhibiting: status lights, blinking lights, and POST error messages during boot. It is important to understand what these indicators mean.

### Status lights

The following table describes basic lights on the computer.

**Table 7-6 Power button functions and lights and their descriptions**

Component	Description
Power button	<p>When the computer is off, press the button to turn on the computer.</p> <p>When the computer is on, press the button briefly to initiate Sleep (Windows) or Suspend (Linux®).</p> <p>When the computer is in the Sleep state, press the button briefly to exit Sleep (Windows) or Suspend (Linux).</p> <p>When the computer is in Hibernation, press the button briefly to exit Hibernation.</p>

**Table 7-6 Power button functions and lights and their descriptions (continued)**

Component	Description
	<p><b>IMPORTANT:</b> Pressing and holding down the power button results in the loss of unsaved information.</p> <p>If the computer stops responding and operating system shutdown procedures are ineffective, press and hold the power button.</p>
Front power light	<p>On: The computer is on.</p> <p>Blinking: The computer is in the Sleep state.</p> <p>Off: The computer is off.</p>
Front AC adapter and battery light	<p>White: The computer is connected to external power, and the battery is charged from 90% to 99%.</p> <p>Amber: The computer is connected to external power, and the battery is charged from 0 to 90%.</p> <p>Blinking amber: A battery that is the only available power source has reached a low battery level. When the battery reaches a critical battery level, the battery light blinks rapidly. By default, the critical battery level is defined in Power Options as 5%.</p> <p>Off: The battery is fully charged.</p>
Front hard drive light	<p>Blinking white: The hard drive is being accessed.</p> <p>Amber: HP 3D DriveGuard has temporarily parked the hard drive.</p>
Rear AC adapter light	<p>White: The computer is connected to external power.</p> <p>Off: The computer is not connected to external power.</p>

### Blinking light codes

During startup, the computer may not boot properly. If this occurs, blinking light codes can help identify the cause.

The computer uses the following blinking lights to identify a hardware component that reports an error during startup. For more information, see [Blinking lights and boot error codes on page 131](#).

**Table 7-7 Blinking light codes and what they mean**

Blink codes	Error
Amber battery light: blinks 1 Hz continuously	Embedded controller unable to load firmware
Caps and num lk lights = 1 blink	Processor not executing code
Caps and num lk lights = 2 blinks	BIOS recovery code unable to find valid BIOS recovery image
Caps and num lk lights = 3 blinks	Memory module error
Caps and num lk lights = 4 blinks	Graphics controller error
Caps and num lk lights = 5 blinks	System board error
Caps and num lk lights = 6 blinks	Intel Trusted Execution Technology (TXT) Error
Caps and num lk lights = 7 blinks	Sure Start unable to find valid BIOS Boot Block image
Caps and num lk lights = 8 blinks	Sure Start has identified a problem (Manual Recovery Policy Set)

## POST error messages

The Power-On Self-Test (POST) is a series of diagnostic tests that runs automatically when the computer is turned on. If the POST encounters a problem, visual error messages are displayed before the operating system starts.

POST checks the following items to ensure that the computer system is functioning properly:

- Memory
- Processors
- BIOS
- Mass storage devices
- Fans

The following table describes errors encountered during HP PC Hardware Diagnostics (UEFI).

**Table 7-8 System diagnostics failure codes and actions to address the failure**

Test description	Failure description	Error code	Suggested user actions
Startup Test	Memory module	200	Attempt to reseat the memory module, and then repeat the test.  For details on troubleshooting issues related to the memory module, search for support documentation at <a href="http://www.hp.com/support">http://www.hp.com/support</a> .
Startup Test	Hard Disk 1 SMART	301	Attempt to reseat the hard drive, and repeat the test. The hard drive may have failed.
Boot Device Manager	Boot device not found	3F0	Reset BIOS. Then reseat the hard drive, and repeat the test.
BIOS Recovery	BIOS Recovery Occurred	500	This message indicates that BIOS recovery was completed successfully. No further action is required.
BIOS Application	BIOS Application Error	501	The BIOS installation may have become corrupted. Download the latest version of the BIOS and install it.  If reinstalling the BIOS fails, contact support for further assistance.
CMOS Recovery	CMOS Recovery Occurred	502	This message indicates that CMOS recovery was completed successfully. No further action is required.
Battery Check	Primary Battery Replace	601	This message indicates that the primary battery has very low capacity. Search for support documentation at <a href="http://www.hp.com/support">http://www.hp.com/support</a> for details on using the HP Support Assistant to verify the battery capacity and, if necessary, order a replacement.
Wireless Modules	Not installed or responding	701	Reseat the wireless LAN adapter module and antennas.  Because seating or reseating a wireless LAN adapter is unique to each computer model, see the WLAN module removal section in the removal and replacement chapter for further details.  Contact support if third-party wireless adapters are installed in the computer.
Fan	Fan not operating correctly	90B	The system fan may be malfunctioning. Replace the fan.

## Resolve the issue

The following sections help you fix the issue.

### 8. Hard reset

A hard reset (or forced reset) erases all information in the computer's memory and may restore functionality. Resetting the computer forces the system to clear and reestablish the connections between the BIOS and the hardware.

For more information, see <http://support.hp.com/us-en/document/c01684768>.

Performing a hard reset might fix the following common conditions:

- Windows stops responding.
- Computer stops before Windows loads, indicated by incomplete startup, blinking cursor on a black background, and errors relating to operating system not found or a missing drive.
- Display suddenly goes blank and stays blank.
- Software freezes.
- Keyboard stops responding.
- The computer does not exit Sleep or Suspend state.
- An external device stops responding. Turn off the power to that device in addition to performing the steps in this document.

Before performing a hard reset, you must disconnect or remove all peripheral devices. Start and test the computer by itself, and if the problem is not resolved, reconnect one peripheral device at a time. To resolve the startup or operational problem, run HP Support Assistant, or manually install all updated drivers from Microsoft and HP.

Before beginning, turn the computer over and look for a battery compartment door (service door). On some platforms, the battery is considered removable but not accessible.

1. Turn off the computer.
2. Remove the computer from any port replicator or docking station.
3. Disconnect all external connected peripheral devices such as USB storage devices, external displays, and printers.
4. Unplug the AC adapter from the computer.
5. Disconnect the battery.
6. Press and hold the power button for at least 15 seconds to drain residual power.
7. Reconnect the battery and plug the AC adapter back into the computer, but do not connect any of the peripheral devices.
8. Press the power button to turn on the computer.
9. If a startup menu appears, use the arrow keys to select **Start Windows Normally**, and then press the [enter](#) key.
10. After reconnecting each of the peripheral devices, run Windows Update and HP Support Assistant to update all device drivers.

CMOS refers to the battery-powered semiconductor chip located on computer's system board. Notebooks store low-level settings like the system time and hardware settings in CMOS. Sometimes you must clear

CMOS, which requires removing and reinserting the 3 V RTC battery for a short time (a few minutes before reinserting), in addition to removing the AC adapter and battery.

---

 **NOTE:** Clearing the CMOS should only be performed for troubleshooting purposes. There is no reason to clear CMOS if the computer is working properly.

You must remove the notebook service door to access the CMOS battery. If the computer has a replaceable RTC battery, see the RTC battery replacement section for the battery removal or replacement.

---

## 9. Soft reset (Default Settings)

If your computer has issues booting, has errors during boot, has issues after you add hardware, or has other abnormal system behaviors that you cannot resolve through any other methods (for example, hard reset), it may be necessary to reset the system BIOS to default settings.

---

 **NOTE:** Some company policies prohibit updates or changes. Check whether the computer has custom BIOS settings before taking action.

---

To load BIOS to default settings: Reboot the computer, and then press **f10 > Main > Restore defaults**. For more information, see <http://support.hp.com>, and the search for **BIOS Setup Utility Information and Menu Options**.

## 10. Reseat cables and connections

Many problems are caused by improper connections or loose connections because of abnormal movement and vibration.

---

 **NOTE:** Before disassembling the computer to reseat cables and connections, always disconnect power and remove the battery, or disconnect a nonremovable battery.

---

See [Cable management on page 141](#) and [Connector types on page 142](#) for suggested cable management practices when you remove and install components.

You can access and reseat connections for Customer Self-Repair (CSR) parts. Examples of reseating hardware include:

- Reseating the battery into the battery bay can resolve no-battery found and no-charging issues.
- Reseating memory modules can resolve memory error, no-boot, and blue screen issues.
- Reseating the hard drive can resolve a POST error 3F0 (no boot device) issue (see [POST error messages and user actions on page 133](#)).
- Reseating the keyboard cable can resolve an unrecognized keys error.
- Reseating the wireless module and antenna cable can resolve a wireless connection issue.

For field replaceable units (FRUs), authorized service providers can try the following steps. For more information, see [Removal and replacement procedures for authorized service provider parts on page 43](#).

- Reseating the fan cable can fix POST error 90B (no fan detected) issue (see [POST error messages and user actions on page 133](#)).
- Reseating the power cable can fix a no-boot issue.
- Reseating the daughterboards can resolve their functional issues. Some models may have items such as a power button board, VGA board, and others.
- Reseating graphics cables and panel connectors can fix distorted or flickering video.
- Replacing thermal pads may resolve thermal power-down issue.

## 11. Test with minimum configuration

The factory-shipped computer (hardware configuration and preinstalled operating system image) is well tested and ready for use. Therefore, using the original factory hardware configuration or booting to operating system safe mode often resolves issues quickly.

- Disconnect any external USB storage, remove any discs in optical drives, remove the computer from a docking station, remove external video, and others.
- In addition to removing recently added components, you can narrow the issue down further with a minimum configuration. For example, if HP PC Diagnostics reports a memory error, test one memory module at a time to isolate the defective module.
- If the computer does not successfully boot the operating system, booting to safe mode may help identify the following possible causes of the issue.

### Essential hardware configuration

If none of the previous steps resolve the issue, start the computer with essential hardware only. The purpose is to remove as much as hardware as possible while still maintaining the computer's ability to turn on.

---

 **NOTE:** This step is to be used by authorized service providers only. HP will not honor the warranty for a system tested with the system board removed without the heat sink or fan.

---

This essential configuration is often used to troubleshoot power-on related issues, such as no-boot, reboot, and freezing issues.

The essential hardware consists of the following components:

- System board
- AC adapter (unplug nonremovable battery or remove battery)
- Processor (and heat sink or fan). (Processor may be integrated into the system board.)
- Memory (one verified working memory DIMM)
- Graphics card (if no VGA port is available on the system board). Platform may have both Intel integrated graphics and discrete graphics. Therefore, you might not need a discrete graphics card.
- External VGA monitor
- External USB keyboard
- External mouse

---

 **NOTE:** After you remove the service door, disconnect all connections (internal keyboard, display, discrete GPU, hard drive or solid-state drive, daughterboards, and so on) to achieve the essential hardware configuration. **Do not** disassemble the system board from its enclosure at this time.

---

Reverse the previous procedure by reinstalling each piece of hardware removed, one piece at a time, and testing your computer after each installation. Because your computer works with only the essential hardware installed, those parts must be working properly. This means that one of the hardware components removed is causing the computer to fail. By installing each device back into the computer and testing each time, you eventually identify the failing hardware.

### Safe mode

A driver conflict often results in a blue screen error message. Booting in safe mode can resolve many issues in Windows because safe mode forces the computer to load a limited version of Windows which contains only essential files.



Safe mode is useful for troubleshooting problems with programs and drivers that might not start correctly or that might prevent Windows from starting correctly. If a problem does not reappear when you start in safe mode, eliminate the default settings and basic device drivers as possible causes. Refer to the following links for how to start your computer in safe mode:

- <http://support.hp.com/us-en/document/c01835750>
- <http://support.hp.com/us-en/document/c03439317>

## 12. Test with verified working configuration (hardware or operating system)

One troubleshooting technique that can quickly isolate an issue is using a verified working part while testing. A good example is to use an external keyboard, mouse, or VGA monitor when you have issues with an internal keyboard, touchpad, or display.

Testing with a verified working AC adapter can identify an error caused by a faulty one. Similarly, testing with a verified working operating system can determine bad behaviors of the current operating system. See [Non HP diagnostics tools on page 85](#) for instructions about obtaining and using a Windows-To-Go USB.



---

**NOTE:** In some situations, more than one item may contribute to a problem.

---

## 13. Replace the system board

Only authorized service providers may replace the system board. This should not be considered an initial step taken to resolve an issue.

Review and perform all steps discussed previously before replacing the system board. [4. Update BIOS and drivers on page 81](#), [7. Status lights, blinking light codes, troubleshooting lights, and POST error messages on page 85](#), [8. Hard reset on page 88](#), and [9. Soft reset \(Default Settings\) on page 89](#), or [10. Reseat cables and connections on page 89](#) can resolve many system board issues without requiring the effort of replacing unnecessary hardware.

Review [Table 7-2 Troubleshooting methodology and general troubleshooting steps on page 78](#) for appropriate troubleshooting steps.



---

**IMPORTANT:** System board failure is not common. Do not replace the system board until you have tried all other troubleshooting options.



**NOTE:** Determine whether a previous service case might be related to the current problem. For example, a fan detection issue could be caused by a loose connection resulting from previous service.



**TIP:** Without an RTC battery (3 V coin-cell battery), the computer automatically reboots. This feature is useful when the power connector cable (between external AC adapter and system board) is defective.



**NOTE:** Most of the time, effective troubleshooting can prevent a system board replacement.

Situations that can prevent resolution of the issue:

- The information provided about the issue omits key details, including any actions taken before the issue occurred.
  - BIOS, software, and drivers have not been updated.
  - Cables or connections are loose.
  - Technician is unaware of information available from the HP Support website (CA - Customer Advisory).
  - The issue is related to existing or known issues that might be identified in existing support articles.
  - Technician might have omitted steps in the provided repair instructions (for example, Spare Part Replacement Instructions).
  - Skipping one of steps from Troubleshooting Methodology table results in No Defect Found (NDF)/No Fault Found (NFF)/No Issue Detected (NID) messages.
- 

## Verify solution

Confirm that the implemented solution works.

- Reboot the system or device, and try to complete the task that produced the issue.
- If a part has been replaced, verify other basic functions. For example, GPU replacement requires keyboard removal. Therefore, it is good practice to verify all basic components to be sure that the solution is complete.
- Explain to the customer why the issue occurred and what was done to resolve it. If the solution you used was in an HP public document, provide the document information to the customer, letting them know they can locate it on <http://www.hp.com>. Also, tell them that there are other solutions available on the website. Advise the customer to check the website first when they have an issue. It might save them time calling in.
- Document the correct issue. Update the case with as many details as possible for other agents and engineers to analyze and study for lessons learned.

## Helpful Hints

After you become familiar with the troubleshooting steps, use the helpful hints before running diagnostics and troubleshooting.

### At startup

These steps provide simple, useful checks that you can perform when troubleshooting.



**TIP:** If you have installed an operating system other than the factory-installed operating system, go to <http://www.hp.com/go/quickspecs> and verify that it is supported on your system.

---

1. Be sure that the computer is plugged into a working AC outlet.
2. Be sure that power is connected to the docking station if you use a dock.
3. Be sure that the AC adapter light is on.
4. Be sure that the AC adapter is connected when you update BIOS to avoid BIOS corruption.
5. Be sure that the computer is turned on, the rear power light is solid white (connected to an external power source), and the front power light is solid white (normal operation).

6. Remove all optical and flash drives from your system before turning it on.
7. Be sure that the boot option is set to a working operating system drive.
8. Be sure that externally connected monitors are turned on and their power lights are on. Not all monitors are equipped with lights to indicate their functionality.
9. Turn up the brightness and contrast controls of a display or external display device if the screen is dim.

## During operation

The following steps provide simple, useful checks that you can perform when troubleshooting.

1. To wake the computer:
  - a. Press the power button or any key on the keyboard.
  - b. If the system remains in the Sleep (Windows), Suspend (Linux), or Hibernate state, shut down the system by pressing and holding the power button for at least 4 seconds.
  - c. If the system does not shut down, unplug the power cord, wait a few seconds, and then plug it in again. Then press the power button again to restart the system.
2. Look for blinking lights on the computer. The blinking lights could be error codes that help diagnose the problem.
3. Check all cables for loose or incorrect connections (external devices, power cords, dock, and so on).
4. After installing a non-Plug and Play expansion board or other option, reconfigure the computer. For example, if you upgrade to a solid-state drive, you might have to reconfigure the boot order.
5. Be sure that all required device drivers have been installed. For example, if you have connected a printer, you must install a printer driver.
6. If there is a network connection issue, plug another computer with a different cable into the network connection. There might be a problem with the network plug or cable.
7. If hardware has recently been installed, remove it and determine whether the computer functions properly.
8. If software has recently been installed, uninstall it and determine whether the computer functions properly.
9. If the screen is blank, confirm the display choice by pressing **Windows logo**  + **p** and set to screen only. Or plug an external monitor into a different video port on the computer, if one is available, and close the computer lid.
10. Verify that the latest version of BIOS, drivers, and software are installed. A new release might support new features or fix the problem.
11. Press the **caps lock** or **num lk** key. If the **caps lock** or **num lk** light toggles on or off, the keyboard is likely operating correctly.
12. Press the touchpad On/Off button light. If the light toggles on or off, the touchpad is likely operating correctly.

## Consulting with HP Service

If further HP support is required, this information may be requested when you call. So it may be helpful to take notes.

- Technical support registration number (if applicable)
- Product serial number
- Product model name and number
- Product identification number
- Applicable error messages
- Add-on boards or hardware
- Third-party hardware or software
- Operating system type and revision level
- Description of symptom or failure

## Common issues and possible solutions

This section contains common issues, symptoms, and a series of tables that describe possible solutions to issues from Failure Classification tables. The following sections identify the issue with symptoms and solutions to resolve an issue.

### Power-on issues

Use the following sections to troubleshooting power issues.

#### No power

When a unit experiences no power, there are several contributing factors to consider. Be sure to consider all symptoms related to this behavior when troubleshooting.

**Table 7-9 Issues, possible causes, and fixes**

Items	Procedures
<i>Symptoms</i>	<i>Possible causes</i>
<ul style="list-style-type: none"> <li>• Computer does not start</li> <li>• Display is black or blank</li> <li>• No fan noise</li> <li>• No hard drive spinning</li> <li>• Lights do not glow</li> </ul>	<ul style="list-style-type: none"> <li>Failed power input to the computer (external power source, AC adapter, faulty battery).</li> <li>Bad connection to the computer (bad power button, power connector).</li> <li>Defective parts (memory, hard drive, graphics) or failed system board.</li> </ul>
	<p><i>Troubleshooting steps</i></p> <p><b>Perform quick check</b></p> <p>Remove all external devices, including docking station.</p> <p>Verify external power source (<a href="#">2. Examine the environment on page 81</a>).</p> <p>Perform a hard reset (<a href="#">8. Hard reset on page 88</a>).</p>
	<p><b>Verify AC adapter</b></p> <p>Verify the battery before verifying the AC adapter. However, you can verify the AC adapter first, before opening the service door for a battery check.</p>

**Table 7-9 Issues, possible causes, and fixes (continued)**

Items	Procedures
	<ul style="list-style-type: none"><li>• Verify AC adapter is compatible with product. Verify that the part number is for this computer if possible.</li><li>• Verify AC adapter and power cord are good (no physical damage, bent middle ID pin).</li><li>• Verify AC adapter works on a verified working computer.</li><li>• Plug in AC adapter and power on computer without battery.</li><li>• Inspect power port on computer side for any damage, dust, or debris.</li><li>• Check power light (<a href="#">7. Status lights, blinking light codes, troubleshooting lights, and POST error messages on page 85</a>). Rear power light indicates external power to the computer is good.</li></ul>
	<p><b>Verify battery condition and status</b></p> <ol style="list-style-type: none"><li>1. Check battery condition (overall result, cycle life, voltage) using HP PC Hardware Diagnostics (UEFI) tool.</li><li>2. Verify that battery is installed properly in battery bay without a gap and that latch locks are tight (for models with removable batteries).</li><li>3. Check battery status light (<a href="#">7. Status lights, blinking light codes, troubleshooting lights, and POST error messages on page 85</a>). Be sure that battery is not fully discharged, preventing system from booting.</li><li>4. Determine whether the computer can turn on with battery only.</li><li>5. Remove service door and test with a verified working battery. If the computer boots, inspect original battery before replacement.</li><li>6. Test battery with a verified working computer to verify that it works.</li><li>7. If the computer still does not boot, remove battery and boot on AC power only.</li></ol>
	<p><b>The following steps are for authorized providers or technicians.</b></p>
	<p><b>Verify AC adapter – voltage</b></p> <ol style="list-style-type: none"><li>1. Measure DC voltage output, which should be approximately 19.5 V dc. Acceptable voltage range is from 18.5 to 20.5 V dc.</li><li>2. If the DC voltage is out of range, replace the AC adapter.</li></ol> <p><b>NOTE:</b> This action requires a digital voltmeter.</p>
<p><b>NOTE:</b> Select models include a power cable between the system board and chassis power connector.</p>	<p><b>Verify power button, power connector</b></p> <ol style="list-style-type: none"><li>1. Be sure that power button is not stuck.</li><li>2. Reseat power connector cable (if applicable).</li><li>3. Replace new power connector cable (if the cable exists and is defective)</li><li>4. To isolate faulty power connector cable and power button, technicians can short power-on pads or pins to turn on the computer. Contact HP Engineering for this information.</li></ol>
	
	<p><b>Verify blinking lights</b> (<a href="#">7. Status lights, blinking light codes, troubleshooting lights, and POST error messages on page 85</a>)</p> <p>At this point, there should be sufficient power from the AC adapter to the system board. Expect to hear the fan spinning and see blinking lights or error messages (for example, faulty memory, HDD).</p>

**Verify Power Good (Troubleshooting) lights**

**Table 7-9 Issues, possible causes, and fixes (continued)**

Items	Procedures
	<ol style="list-style-type: none"> <li>1. Verify whether the system board has a related power-on issue. If there is no power-on issue, move to next steps.</li> <li>2. Verify all connections and reseat parts (<a href="#">10. Reseat cables and connections on page 89</a>).</li> </ol>
	<p><b>Verify system board</b></p> <ol style="list-style-type: none"> <li>1. Test essential hardware configuration (<a href="#">11. Test with minimum configuration on page 90</a>, <a href="#">12. Test with verified working configuration (hardware or operating system) on page 91</a>, <a href="#">13. Replace the system board on page 91</a>) by removing nonessential parts.</li> <li>2. If the computer still does not boot, replace system board.</li> </ol>
<b>Tips</b>	<p>Computer automatically boots without pressing power button when the RTC 3 V battery is removed. Therefore, after the service door and RTC 3 V battery are removed, you do not have to press power button from top side.</p> <p>In essential hardware configuration, mWS G1 and G2 may require discrete graphics processing unit (GPU) to boot. However, mWS G3 can boot with integrated graphics.</p>

## Intermittent power-on, shutdown, reboot

Use this information to troubleshoot power-on, shutdown, and reboot issues.

**Table 7-10 Issues, possible causes, and fixes**

Items	Procedures
<p><i>Symptoms</i></p> <ul style="list-style-type: none"> <li>• Does not always turn on</li> <li>• Intermittently hangs</li> <li>• Intermittently shuts down</li> <li>• Spontaneously reboots</li> </ul>	<p><i>Possible causes</i></p> <p>Electrical short, fluctuating power source, unstable power rails, loose connections, bent pins, stray wires, dust, obvious damage, nearly faulty parts (bulging or leaking capacitor).</p> <p>Potentially turn into a no-power issue (<a href="#">No power on page 94</a>).</p>
	<p><i>Troubleshooting steps</i></p> <ol style="list-style-type: none"> <li>1. Visually check power ports on both AC adapter and computer sides.</li> <li>2. Inspect power sources: <ol style="list-style-type: none"> <li>a. Verify that the AC adapter is working correctly. Use a confirmed working adapter to test.</li> <li>b. Verify that battery is not depleted while system is in the Sleep state. Test with a confirmed working battery.</li> </ol> </li> </ol>

**The following steps are for authorized providers or technicians.**

1. Follow actions in [No power on page 94](#).
  - a. Be sure that AC adapter has correct DC voltage.
  - b. Verify battery: test with a confirmed working battery.
  - c. Verify that power button is not stuck.
  - d. Verify that power connector is not loose.
  - e. Verify that Power Good LEDs are solid.

**Table 7-10 Issues, possible causes, and fixes (continued)**

Items	Procedures
	<ol style="list-style-type: none"> <li>f. Remedy loose connections and reseat major components (processor, memory, GPU, hard drive, solid-state drive, and others).</li> </ol>
	<ol style="list-style-type: none"> <li>2. Perform visual check for loose connections, bent pins, stray wires, dust, nearly faulty parts (bulging or leaking capacitor).</li> </ol>
	<ol style="list-style-type: none"> <li>3. Test <b>essential hardware configuration</b> (<a href="#">11. Test with minimum configuration on page 90</a>) <ol style="list-style-type: none"> <li>a. If system boots, reinstall nonessential hardware one component at a time to isolate issue.</li> <li>b. If system does not boot, replace essential hardware with verified working parts, one component at a time. If system still does not boot, replace system board.</li> </ol> </li> </ol>

## AC adapter issue

Use this information to troubleshoot AC adapter issues.

**Table 7-11 Issues, possible causes, and fixes**

	Solution
<i>Symptoms</i>	<i>Possible causes</i>
<ul style="list-style-type: none"> <li>• No sign of power</li> </ul>	AC adapter and others (for example, external power source).
<ul style="list-style-type: none"> <li>• No boot</li> </ul>	<i>Troubleshooting steps</i>
<ul style="list-style-type: none"> <li>• No rear power light</li> </ul>	<b>Quick check</b>
<ul style="list-style-type: none"> <li>• No front power light</li> </ul>	<ol style="list-style-type: none"> <li>1. Verify external power source (<a href="#">2. Examine the environment on page 81</a>).</li> <li>2. Remove all external devices, including docking station.</li> <li>3. Perform a hard reset for the computer (<a href="#">8. Hard reset on page 88</a>).</li> <li>4. Disconnect and reassemble the power cord and adapter in case the adapter experienced short circuit, over current, over temperature events.</li> <li>5. Use a verified working adapter. If the computer operates normally, there is a problem with the original adapter.</li> <li>6. Verify that the AC adapter works on a verified working computer. If the computer operates normally, there is no problem with the adapter. See <a href="#">HP Smart Adapter warning message on page 108</a> for further information.</li> </ol>
<ul style="list-style-type: none"> <li>• Battery does not charge when AC adapter is connected</li> </ul>	<b>Verify AC adapter</b>
	<ol style="list-style-type: none"> <li>1. Remove working battery.</li> <li>2. Verify that AC adapter is compatible with product. Verify that part number is for this computer if possible.</li> <li>3. Inspect AC adapter and power cord for physical damage, bent middle ID pin.</li> <li>4. Plug in AC adapter and power the computer without battery.</li> <li>5. Inspect the power port on computer side for any damage, dust, debris.</li> <li>6. Check power light (<a href="#">7. Status lights, blinking light codes, troubleshooting lights, and POST error messages on page 85</a>). Rear power light indicates that external power to the computer is good.</li> </ol>

**Table 7-11 Issues, possible causes, and fixes (continued)**

	<b>Solution</b>
	<p>7. If there is still no rear power light or no boot, replace the AC adapter.</p>
<b>Tips</b>	<p>The HP Smart AC adapter has a special pin in the middle, called the ID pin, for power rating and throttling. If this pin is broken, the rear power light turns on, but the power button and front power lights blink continuously, and the computer does not turn on. Third-party AC adapters do not work with the computer.</p> <p>Use the AC adapter that came with the computer for better performance.</p>

## Battery not recognized, not charging

Use this information to troubleshoot battery issues.

**Table 7-12 Issues, possible causes, and fixes**

<b>Items</b>	<b>Procedures</b>
<i>Symptoms</i>	<i>Possible causes</i>
<ul style="list-style-type: none"> <li>No battery status light</li> <li>Blinking amber (critically low battery level)</li> <li>No boot without AC adapter</li> </ul>	<p>Defective AC adapter , battery, or both.</p> <p><b>NOTE:</b> Before proceeding, verify that the computer can boot to BIOS or Windows with a good AC adapter.</p>
	<i>Troubleshooting steps</i>
	<p><b>Visual inspections</b></p> <ol style="list-style-type: none"> <li>Inspect battery connectors for any signs of damage.</li> <li>Verify that battery is installed properly in battery bay without gap or obstructions and latch locks are tight. Reseat battery (for models with removable batteries).</li> <li>Determine whether battery gets hot (batteries heat up when charging, but not too hot to touch).</li> </ol> <p><b>Check battery warranty</b> to see whether the battery is new or its warranty is expired. Battery capacity degrades over time.</p> <p><b>Verify front battery status light</b></p> <ol style="list-style-type: none"> <li>Battery status light is off: battery not recognized.</li> <li>Battery status light is blinking amber: critically low battery level.</li> </ol> <p><b>Reset</b></p> <ol style="list-style-type: none"> <li>Hard reset (<a href="#">8. Hard reset on page 88</a>)</li> <li>Soft reset (<a href="#">9. Soft reset (Default Settings) on page 89</a>)</li> </ol> <p><b>Verify AC adapter</b></p> <ol style="list-style-type: none"> <li>Determine whether the computer needs the AC adapter to boot and operate. Sometimes, an intermittently bad AC adapter and loose connection between adapter and computer results in inability to charge battery, which causes short run time.</li> <li>Inspect AC adapter to verify that it is functioning.</li> <li>Test with a working AC adapter and confirm whether battery is charging.</li> <li>Be sure that battery is fully charged (AC adapter plugged in at least 2.5 hours).</li> </ol>



**Table 7-12 Issues, possible causes, and fixes (continued)**

Items	Procedures
	<p><b>Diagnostics:</b> HP tools report results such as passed, calibrate, weak, replace, no battery, and unknown, and they suggest corresponding actions.</p> <p><b>Use HP Hardware Diagnostics (UEFI)</b> (6. HP Hardware Diagnostics and Tools on page 82)</p> <p>HP PC Hardware Diagnostics (UEFI) is a good tool to use to isolate and determine faulty battery, especially for quickly discharging (short life) battery.</p> <ol style="list-style-type: none"> <li>1. Verify that battery is recognized and charging.</li> <li>2. Verify battery condition if battery cycle life is past its life expectancy (that is, past 1000-cycle life and 3-year warranty). Battery might need to be replaced.</li> <li>3. If issue remains, test with a verified working battery and verify battery status lights and battery conditions.</li> <li>4. If issue remains, replace system board.</li> <li>5. Verify the new replacement.</li> </ol>
<b>Tips</b>	<p>See the computer user guide for instructions regarding battery maintenance and increasing battery life. Also see <a href="http://support.hp.com/us-en/document/c01297640?jumpid=hpr_r1002_usen_link3">http://support.hp.com/us-en/document/c01297640?jumpid=hpr_r1002_usen_link3</a>.</p>

## Battery discharges too fast

Use this information to troubleshoot battery issues.

**Table 7-13 Issues, possible causes, and fixes**

Items	Procedures
<i>Symptoms</i>	<i>Possible causes</i>
Battery has good status light but discharges too fast	AC adapter, battery, or both.
	<i>Troubleshooting steps</i>
	<p><b>Verify AC adapter</b></p> <p>Determine whether the computer needs the AC adapter to boot and operate. Sometimes an intermittently bad AC adapter and loose connection between adapter and computer results in the inability to charge the battery and causes short runtime.</p> <ol style="list-style-type: none"> <li>1. Inspect AC adapter to verify that it is working.</li> <li>2. Test with AC adapter alone and with a verified working AC adapter.</li> </ol>
	<p><b>Verify battery:</b> Because battery capacity can degrade over time, check the warranty coverage. Run a battery test to confirm whether issue is hardware related.</p> <ol style="list-style-type: none"> <li>1. Review battery power plans in <b>Control Panel &gt; Power Options</b> that may consume more energy and discharge battery faster. Resetting default to <b>Power Saver</b> option can conserve battery power.</li> <li>2. Determine whether any graphics are processing.</li> <li>3. Verify battery maintenance and operations. Leaving the battery at a high level of charge in a high-temperature environment for extended periods accelerates the loss of capacity.</li> <li>4. Test and calibrate battery using HP PC Hardware Diagnostics (UEFI).</li> <li>5. Verify battery life cycle using HP Support Assistant tool.</li> </ol>

**Table 7-13 Issues, possible causes, and fixes (continued)**

Items	Procedures
	<p>If battery cycle life is past its life expectancy (past the 1000-cycle life and 3-year warranty), the battery might need to be replaced.</p> <p><b>6.</b> Compare discharge time with a verified working battery (remove AC adapter) using <b>Hardware Diagnostics (UEFI)&gt;Hard Drive Tests&gt;Extensive Test&gt;Loop until error</b>.</p>
<b>Tips</b>	<p>To conserve battery power, turn off Wireless On-Off button and other peripherals and USB devices, applications, processes (in Task Manager) when not in use; also, reduce screen brightness.</p> <p>Follow HP instructions about how to maintain battery and increase battery life. Also reference <a href="http://support.hp.com/us-en/document/c01297640?jumpid=hpr_r1002_usen_link3">http://support.hp.com/us-en/document/c01297640?jumpid=hpr_r1002_usen_link3</a>.</p>

## Burnt smell

Use this information to troubleshoot burnt-odor issues.

**Table 7-14 Issues, possible causes, and fixes**

Items	Procedures
<i>Symptoms</i>	<i>Possible causes</i>
Emits smoke, burnt smell	Defective on-board components.
	<i>Troubleshooting steps</i>
	<b>General visual inspection</b>
	<ol style="list-style-type: none"> <li>1. Disconnect the computer from power source (AC adapter and battery).</li> <li>2. Inspect for visual damage on AC adapter and battery. Test on a known working computer to isolate issue. If issue follows AC adapter or battery, replace it.</li> <li>3. Inspect any sign of liquid spill on the computer (back of keyboard).</li> </ol>
	<b>The following steps are for authorized providers or technicians.</b>
	<b>Further inspection on components</b>
	<ol style="list-style-type: none"> <li>1. Inspect further sources internally after disassembling chassis, such as burnt or damaged components.</li> <li>2. If the issue persists, replace boards, AC adapter, and battery for safety concern, and report issues to HP.</li> </ol>

## POST

Use the following sections to troubleshoot Power-on Self Test issues.

### No video (with power)

Use this information to troubleshoot video issues.

**Table 7-15 Issues, possible causes, and fixes**

Items	Procedures
<p><i>Symptoms</i></p> <ul style="list-style-type: none"> <li>• No video (black or blank image) but have power</li> <li>• Light activity</li> <li>• No error messages</li> <li>• Fan noise</li> <li>• Hard drive light blinking and hard drive noise</li> </ul>	<p><i>Possible causes</i></p> <p>Failed display</p> <p>Failed critical components (memory, hard drive, system board)</p> <p>Loose connection</p> <p>Recently added hardware</p> <p><b>NOTE:</b> These suggestions assume that the computer has not previously been set up for multiple displays.</p>
	<p><i>Troubleshooting steps</i></p> <p><b>Quick check</b></p> <ol style="list-style-type: none"> <li>1. Verify that system light activity is OK.</li> <li>2. Remove all external devices, including docking station. Recently added hardware or applications may cause graphics driver conflict and result in loss of video.</li> <li>3. Perform hardware reset (<a href="#">8. Hard reset on page 88</a>) and verify that HP Logo is presented correctly on display screen when pressing <b>F10</b>.</li> <li>4. Test with external monitor via VGA port (or DisplayPort, HDMI, or other). Press power button and close the computer lid to force video output to external video. If unsuccessful, contact HP service.</li> <li>5. If external video is OK, update BIOS, software, and drivers (<a href="#">4. Update BIOS and drivers on page 81</a>), and perform soft reset (<a href="#">9. Soft reset (Default Settings) on page 89</a>) if needed. Go to next step to verify display.</li> </ol>
	<p><b>Verify display</b></p> <ul style="list-style-type: none"> <li>• When booting to Windows, determine whether image appears on display screen (via Windows Screen Solutions or <a href="#">Windows logo</a>  + p for display switcher).</li> <li>• If there is video on the display, disconnect external display device, open the computer lid, and restart.</li> </ul>
<p><b>The following steps are for authorized providers or technicians.</b></p>	
	<ol style="list-style-type: none"> <li>1. Reseat display cable connection on system board.</li> <li>2. Reseat display cable connection on display panel side.</li> <li>3. Examine and reseat major components, such as hard drive and memory.</li> <li>4. Test with minimum configuration (<a href="#">11. Test with minimum configuration on page 90</a>) by removing hard drive to isolate operating system issues and testing video in F10 Setup.</li> <li>5. If video is present, restart and retest the computer.</li> <li>6. If video is present but bad, go to <a href="#">Display on page 109</a> section.</li> <li>7. If issue persists (no video), test with external video.</li> <li>8. If issue persists, test or replace a confirmed working display.</li> <li>9. If issue persists, replace discrete graphics card.</li> <li>10. If issue persists, replace system board because of defective video function.</li> </ol>
<p><b>Tips</b></p>	<p>Swipe a metal piece (screwdriver) over wireless or mute buttons to act as if closing lid to force video output to external display device.</p>

## Blinking lights

Use this information to interpret blinking lights on the computer.

**Table 7-16 Issues, possible causes, and fixes**

Items	Procedures
<i>Symptoms</i>	<i>Possible causes</i>
Lights blink on keyboard <b>caps lock/num lock</b> keys	Blinking lights on startup usually indicate a problem with basic functionality of a critical component (processor, BIOS, graphics cards, memory, and so on) because of a loose connection, defective parts, or recently added parts.
	<i>Troubleshooting steps</i>
	<ol style="list-style-type: none"><li>1. Check for any blink patterns. Count the number of blinks in a sequence, followed by a pause for a few seconds.</li><li>2. See status, blinking lights, and error message (<a href="#">7. Status lights, blinking light codes, troubleshooting lights, and POST error messages on page 85</a>) for corrective actions.</li><li>3. If internal hardware components (such as memory, hard drive) have been recently added, a component may not be connected properly. Remove and reseal new components (<a href="#">10. Reseat cables and connections on page 89</a>) one at a time.</li></ol>
<b>Note</b>	Because the display might not be functional, lights are used to indicate an error.

## Diagnostic error messages

Use the information in the table to help you understand diagnostic error messages.

**Table 7-17 Issues, possible causes, and fixes**

Items	Procedures
<i>Symptoms</i>	<i>Possible causes</i>
<ul style="list-style-type: none"><li>• Computer has power</li><li>• POST error message displays (Windows logo has not yet appeared)</li></ul>	Diagnostic error messages indicate a problem. There may be a problem with the instruction being sent from the BIOS to a hardware component (for example, keyboard failures), or incompatible hardware. Can usually be resolved by installing updated firmware for the component.
	<i>Troubleshooting steps</i>
	<ol style="list-style-type: none"><li>1. See <a href="#">7. Status lights, blinking light codes, troubleshooting lights, and POST error messages on page 85</a> for corrective actions. An example of a POST error message might be "Boot Device Not Found."</li><li>2. If there is power, you might be able to access BIOS. Reset BIOS to its default condition. (<a href="#">9. Soft reset (Default Settings) on page 89</a>)</li><li>3. Restore hardware to its original condition (for example, bootable solid-state drive instead of hard drive).</li><li>4. Reseat suspected components and verify connection.</li><li>5. Test suspected components using HP PC Hardware Diagnostics (UEFI) tool.</li></ol>
<b>Note</b>	An Error Message means that the system has finished BIOS hardware validation and is ready to launch the <b>Startup Menu</b> . To access the <b>Startup Menu</b> for further options, press the <b>esc</b> key while restarting the computer.

## BIOS password

Use the information in the table to troubleshoot BIOS password issues.

**Table 7-18 Issues, possible causes, and fixes**

Items	Procedures
<i>Symptoms</i>	<i>Possible causes</i>
Some sections are unavailable (grayed out)	You must use an administrator password.
	<i>Troubleshooting steps</i>
	<ol style="list-style-type: none"><li>1. Review F10 BIOS Setup Overview to determine which features must be enabled.</li><li>2. Your BIOS settings may be managed by a BIOS administrator password setup.</li><li>3. If you lost or forgot the user password, contact your IT personnel.</li></ol>
<b>Reference</b>	<b>HP F10 Setup Overview</b> <a href="http://h10032.www1.hp.com/ctg/Manual/c04460979">http://h10032.www1.hp.com/ctg/Manual/c04460979</a> <a href="http://h10032.www1.hp.com/ctg/Manual/c04685655">http://h10032.www1.hp.com/ctg/Manual/c04685655</a> 2015 Business PC models: see the HP PC BIOS F10 Setup Guide at <a href="http://support.hp.com">http://support.hp.com</a> .

## Performance (OS)

Most software problems occur as a result of certain situations.

- The application was not installed or configured correctly.
- There is insufficient memory available to run the application.
- There is a conflict between applications.

Make sure that all the necessary device drivers are installed.

If an operating system other than the factory operating system is installed, check whether the operating system is supported and the application is certified for the version of the operating system.

## Intermittent shutdown

Use this information to troubleshoot shutdown issues.

**Table 7-19 Issues, possible causes, and fixes**

Items	Procedures
<i>Symptoms</i>	<i>Possible causes</i>
<ul style="list-style-type: none"><li>• Shutdown during startup</li><li>• Shutdown during operation</li></ul>	It is often difficult to troubleshoot an intermittent issue. Possible causes include: Power-related issue: defective or insufficient power sources, poor connection. OS Custom Setting: Energy Saver (Power Management). Thermal-related issue: thermal sensors reach limits. Hardware related issue, voltage, out-of-range current, electrical short.
	<i>Troubleshooting steps</i>
	<ol style="list-style-type: none"><li>1. Update BIOS and drivers. (<a href="#">4. Update BIOS and drivers on page 81</a>)</li></ol>

**Table 7-19 Issues, possible causes, and fixes (continued)**

Items	Procedures
	<ol style="list-style-type: none"><li data-bbox="608 260 1449 289">2. Perform hard reset (<a href="#">8. Hard reset on page 88</a>)</li><li data-bbox="608 302 1449 331">3. Perform soft reset (<a href="#">9. Soft reset (Default Settings) on page 89</a>)</li></ol>
	<p data-bbox="608 354 1449 384"><b>Power-related issue</b></p> <ol style="list-style-type: none"><li data-bbox="608 401 1449 457">1. Verify functionality of AC adapter alone. If it does not work, test with a verified working adapter.</li><li data-bbox="608 470 1449 527">2. Verify battery alone. Verify that battery is not depleted. Test battery using HP PC Hardware Diagnostics (UEFI) tool.</li><li data-bbox="608 539 1449 569">3. Verify connection of power button and cable.</li></ol>
	<p data-bbox="608 592 1449 621"><b>OS custom settings</b></p> <ol style="list-style-type: none"><li data-bbox="608 638 1449 695">1. Advise users to reset power options and close all applications that are not in use, including applications in the background.</li><li data-bbox="608 707 1449 764">2. Test with a confirmed working operating system to isolate custom settings by users or any conflicting applications that cause shutdown.</li></ol>
<p data-bbox="245 785 1449 814"><b>The following steps are for authorized providers or technicians.</b></p>	
	<p data-bbox="608 837 1449 867"><b>Thermal-related issue</b></p> <ol style="list-style-type: none"><li data-bbox="608 879 1449 1348">1. Verify thermal condition:<ol style="list-style-type: none"><li data-bbox="667 921 1449 978">a. Test fan using HP PC Hardware Diagnostics (UEFI) tool (<a href="#">6. HP Hardware Diagnostics and Tools on page 82</a>)</li><li data-bbox="667 991 1449 1020">b. Check fan and connection. Reseat fan cable.</li><li data-bbox="667 1033 1449 1062">c. Be sure that no obstructions or dust are in heat sink fan, fin, or vent.</li><li data-bbox="667 1075 1449 1104">d. Test with a verified working fan.</li><li data-bbox="667 1117 1449 1173">e. Remove old thermal compound and pads and replace with new compound and pads.</li></ol></li><li data-bbox="608 1186 1449 1348">2. Verify thermal solution:<ul style="list-style-type: none"><li data-bbox="667 1243 1449 1348">○ Use Thermal Monitor tool (available only to authorized service providers/ technicians) to perform stress test (processor and GPU) (<a href="#">6. HP Hardware Diagnostics and Tools on page 82</a>), and verify that thermal sensors are within limits after thermal condition is serviced.</li></ul></li></ol>
	<p data-bbox="608 1373 1449 1402"><b>Hardware-related issue</b></p> <ol style="list-style-type: none"><li data-bbox="608 1415 1449 1472">1. Check for any signs of loose connections, bent pins, stray wires, dust, nearly faulty parts (bulging/leaking capacitor).</li><li data-bbox="608 1484 1449 1514">2. Verify that lights are solid.</li><li data-bbox="608 1526 1449 1703">3. If shutdown is reproducible, test essential hardware configuration:<ol style="list-style-type: none"><li data-bbox="667 1583 1449 1640">a. If no issue with hardware configuration, reinstall one nonessential component at a time to determine faulty hardware.</li><li data-bbox="667 1652 1449 1703">b. If issue persists, replace essential hardware with a confirmed working part, one at a time. If the computer does not boot, replace system board.</li></ol></li></ol>
<p data-bbox="245 1730 608 1759"><b>Tips</b></p>	<p data-bbox="608 1730 1449 1816">Intermittent issues are difficult to reproduce and troubleshoot. It is important to record details about shutdown frequencies, system configuration (3D video application), and operating conditions.</p>

## Blue screen

Use this information to troubleshoot blue screen issues.

## Freeze at Windows Logo (hang or lockup)

Use the following information to troubleshoot hang or lockup issues.

**Table 7-20 Issues, possible causes, and fixes**

Items	Procedures
<i>Symptoms</i>	<i>Possible causes</i>
<ul style="list-style-type: none"><li>• Has power, light activity, fan spinning</li><li>• HP Logo displays briefly</li><li>• Attempt to boot to operating system and freeze/hang at Windows logo</li><li>• No response to pressing <b>num lk</b> or <b>caps lock</b> key</li></ul>	Conflict of instructions from multiple programs or drivers; installing a new hardware or program that is not compatible (may also cause a blue screen error—see blue screen issue).



### *Troubleshooting steps*

Perform the following steps one at a time to verify normal boot process:

1. Disconnect all external peripherals, and perform a hard reset ([8. Hard reset on page 88](#)).
2. Perform soft reset ([9. Soft reset \(Default Settings\) on page 89](#)).
3. Update BIOS and drivers ([4. Update BIOS and drivers on page 81](#)).
  - a. Roll back to previous version may be necessary.
  - b. Go to safe mode to install drivers.
4. Run Hardware Diagnostics ([6. HP Hardware Diagnostics and Tools on page 82](#)) to isolate hardware issue.
5. Undo recent changes in Windows ([5. Remove or uninstall recently added hardware, software on page 82](#)).
6. Reseat cables and connections ([10. Reseat cables and connections on page 89](#)).
7. Start Windows in safe mode ([11. Test with minimum configuration on page 90](#)).
8. Use Startup Repair Windows to fix Windows damaged files.

**Table 7-20 Issues, possible causes, and fixes (continued)**

Items	Procedures
	<ol style="list-style-type: none"> <li>Test with essential hardware configuration (<a href="#">11. Test with minimum configuration on page 90</a>) with a verified working operating system (for instance, USB Windows-To-Go), if available, to isolate the software issue.</li> </ol>
<b>Tips</b>	For more information, see <a href="http://support.hp.com/us-en/document/c03671001">http://support.hp.com/us-en/document/c03671001</a> .

## Electromagnetic Interference (EMI)

Use this information to troubleshoot EMI issues.

**Table 7-21 Issues, possible causes, and fixes**

Items	Procedures
<i>Symptoms</i>	<i>Possible causes</i>
System locks up, freezes in certain physical area or location	Electromagnetic interference (EMI).
	<i>Troubleshooting steps</i>
	<ol style="list-style-type: none"> <li>See (<a href="#">2. Examine the environment on page 81</a>). Pay attention to external power source, high-frequency signals such as cell phones, microwave ovens.</li> <li>Move the computer to different locations nearby to determine where it fails and where it does not fail.</li> <li>Test with a verified working computer in original factory configuration.</li> <li>Consult with support.</li> </ol>

## No wake up

Use this information to troubleshoot wake-up issues.

**Table 7-22 Issues, possible causes, and fixes**

Items	Procedures
<i>Symptoms</i>	<i>Possible causes</i>
When resuming from a power management state the computer may display:	Power-saving mode; multiple-display setting.
	<i>Troubleshooting steps</i>
<ul style="list-style-type: none"> <li>Blank screen</li> <li>Some light activity</li> </ul>	<ol style="list-style-type: none"> <li>Verify that front power light (<a href="#">7. Status lights, blinking light codes, troubleshooting lights, and POST error messages on page 85</a>) is blinking (indicating Sleep state). Press power button to exit Sleep.</li> <li>Reset BIOS to default (associated with <b>OS Power Management in Power Menu</b>) (<a href="#">4. Update BIOS and drivers on page 81</a>)</li> <li>Check power management settings in Windows <b>Power Options</b>. Disable Sleep options if the issue is resolved.</li> </ol>



**Table 7-22 Issues, possible causes, and fixes (continued)**

Items	Procedures
-------	------------



4. Screen saver is set. Press any key or touch touchpad to resume.
5. Verify that Display Choice is set to external video only. Toggle screen control key combination **fn + f4** or **Windows logo + P**.

**Tips**

If you are using a docking station, set your notebook display as a primary display. When the computer is undocked, you may think it is in a power-saving state, but the screen image may actually appear on an external display device in the docking configuration.

## Unresponsive

Use this information to troubleshoot issues with responsiveness.

**Table 7-23 Issues, possible causes, and fixes**

Items	Procedures
<i>Symptom</i>	<i>Possible causes</i>
Unresponsive	Program in use has stopped responding to commands.
	<i>Troubleshooting steps</i>
	<ol style="list-style-type: none"> <li>1. If possible, use the Windows Task Manager to isolate and terminate the offending process.</li> <li>2. Attempt the normal Windows shutdown procedure.</li> <li>3. Restart the computer using the power button.</li> </ol>

## Slow performance

Use this information to troubleshoot performance issues.

**Table 7-24 Issues, possible causes, and fixes**

Items	Procedures
<i>Symptom</i>	<i>Possible causes</i>
Slow performance when performing small tasks, or even in idle mode	Processor is hot or hard drive is full.
	<i>Troubleshooting steps</i>
	<b>Processor is hot</b>
	<ol style="list-style-type: none"><li>1. Verify that airflow to the computer is not blocked.</li><li>2. Verify that chassis fans are connected and working properly. Some fans operate only when needed.</li><li>3. Verify that the processor heat sink is installed properly.</li></ol>
	<b>Hard drive is full</b>
	<ol style="list-style-type: none"><li>1. Transfer data from the hard drive to create more space on the hard drive. Microsoft recommends at least 200 MB to sync system files.</li><li>2. Perform disk defragmentation to consolidate fragmented data on the hard drive so it works more efficiently.</li></ol>
<b>Tips</b>	See <a href="#">Routine maintenance for performance improvement on page 135</a> ).

## HP Smart Adapter warning message

Use this information to troubleshoot power adapter warning messages.

**Table 7-25 Issues, possible causes, and fixes**

Items	Procedures
<i>Symptom</i>	<i>Possible causes</i>
Warning message appears in window	Less powerful AC adapter, BIOS out of date.



### *Troubleshooting steps*

1. Update BIOS, which may contain information that assigns an appropriate adapter for the configuration.
2. Update the latest **HP Hotkey Support** software from Drivers website.
3. Be sure that the power source is sufficient (where adapter is connected).

**Table 7-25 Issues, possible causes, and fixes (continued)**

Items	Procedures
	<ol style="list-style-type: none"> <li>4. Use appropriate AC adapter (often supplied with system) for optimum system performance.</li> <li>5. Test with a verified working AC adapter.</li> <li>6. Test the adapter on a verified working computer.</li> <li>7. Contact HP for configuration details.</li> </ol>
<b>Note</b>	<p><b>HP Smart AC adapter warning message:</b> informs you that as power demands increase, the notebook may not perform at full capacity, which may result in longer battery-charging time. In cases of extreme power demands, the system may also throttle back the processor, or with systems that have a discrete video subsystem, a video balance mode may occur to further balance the power needs of the system.</p> <p>Because system processor functions always have priority over battery charging, charging delays occur first.</p>

## Incorrect time and date

Use the following information to troubleshoot time and date issues.

**Table 7-26 Issues, possible causes, and fixes**

Item	Procedure
<i>Symptom</i>	<i>Possible cause</i>
Incorrect date and time	Real-time clock (RTC) battery might need replacement.
	<i>Troubleshooting steps</i>
	<ol style="list-style-type: none"> <li>1. Reset the date and time in the operating system Control Panel.</li> <li>2. Replace the RTC battery.</li> <li>3. Verify that date and time are correct.</li> </ol>

## Display

Use these sections to troubleshoot display issues.

### Display anomalies

The display panel is a field-replaceable unit (FRU) and must be replaced by only authorized technicians. However, HP highly recommends that users and technicians observe symptoms and use the HP PC Hardware Diagnostics (UEFI) tool before any replacement.



#### Symptom

This section includes common display issues with symptoms:

- Blank or black video
- Incorrect color, missing color, distorted image
- Flickering image
- Vertical lines (because of LDVS, decreased signal integrity, and data loss)

- Dead pixel (because of display liquid, internal transistor, and others)
- Horizontal lines (because of video memory)
- Distorted when hot (because of thermal issue)
- Cracked screen/image (physical damage)
- Light leakage/bleeding  
Contact support for assistance.
- Humming noise (due to frequency settings)  
Contact support for assistance.

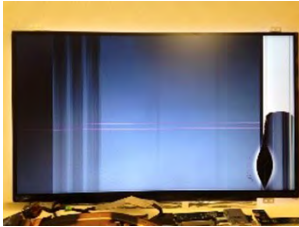
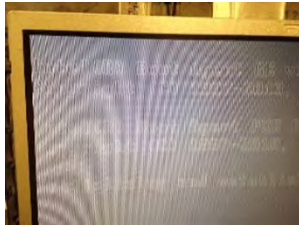
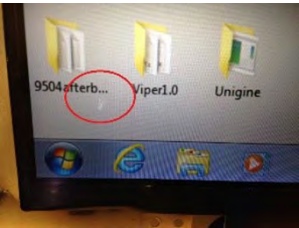
**Table 7-27 Display anomaly illustrations**

Display anomalies		
		
Cracked screen	Cracked image	Blurred image
		
Dead pixel	Vertical lines	Horizontal lines

### Quick check

Use these steps to check the display.

- Visually examine the display for cracked screen, liquid crystal leak, dirty spots on glass, and other issues.
- Reset and update BIOS and docking firmware.
- Update operating system (OS), graphics or video drivers (Intel, AMD, NVIDIA, and others).

For custom images, HP highly recommends upgrading or installing Windows in UEFI mode (or Legacy disabled) to fully support hybrid graphics and avoid unexpected behaviors (for example, blue screen error, graphics or video issues) in the BIOS Legacy setting.

- Configure Windows settings (Power options, Screen brightness, Personalization, Screen resolution, and so on).
- Test with a verified working external display.

- Boot to Windows in safe mode.
- Test with a verified working operating system (for instance, shipping image).

### HP PC Hardware Diagnostics (UEFI) for video test

Use this tool to quickly determine if the display issue is related to a real hardware issue.

To start HP PC Hardware Diagnostics (UEFI) ([6. HP Hardware Diagnostics and Tools on page 82](#)), when the computer is at boot, press the **F2** key, select **Component Tests**, and then select **Video**.

There are three options:

- **Video Memory Check:** to test video memory
- **Palette Check:** to test the three video color components (red, green, blue)
- **Dead Pixel Check:** to check dead pixels in eight different colors (Dead Pixel Check is available with the HP PC Diagnostics 3-in-1 USB Key tool)

Review the video troubleshooting in the following Display section for specific issues and possible solutions. For additional information about display problems, see documentation provided by the product manufacturer.

### Display assembly diagram

The display assembly diagram shows basic video components: system board, graphics cards, display cables, display connectors, operating system (OS), graphics driver, and LCD display panel. Any component or a combination of these components can contribute to a video issue.

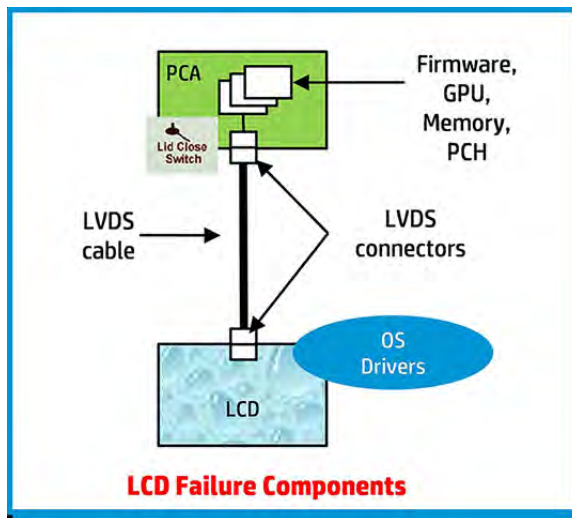

**NOTE:** The lid close switch is a Hall-effect sensor located in the top cover. When the display is closed, the sensor acts like a switch is closed. A notebook can force a video output to an external monitor, or go to hibernation or standby mode through power management. If the display screen does not light up when the display is open, the lid close switch (Hall-effect sensor) could be faulty.

### Dead pixel

Display panel may show one or more pixels that are not properly lit when displaying a single color over the screen area. Use HP PC Hardware Diagnostics (UEFI) tool to determine those defective pixels.

There is no solution for dead pixels. See [Display issue: pixel anomalies on page 140](#) for the HP dead pixel policy.

## No video (internal)

Use this information to troubleshoot video issues.

**Table 7-28 Issues, possible causes, and fixes**

Items	Procedures
<i>Symptoms</i>	<i>Possible causes</i>
No internal video with certain programs (for example, video-intensive games)	Display resolution, brightness, faulty lid switch, running a program requiring a higher resolution than the display screen can support.  Faulty lid switch may put the system into Sleep or Hibernation mode.
	<i>Troubleshooting steps</i>
	Use an external monitor with higher resolution.  Test with external monitor using HDMI or HP port. Press the power button and close the computer lid to force video output to external video. If there is still no video, contact support.
<b>References</b>	See section <a href="#">No video (with power) on page 100</a> for display information.

## No video (external)

Use this information to troubleshoot external video issues.

**Table 7-29 Issues, possible causes, and fixes**

Items	Procedures
<i>Symptom</i>	<i>Possible causes</i>
No image on external monitor	External monitor, resolution, display configuration, drivers.
	<i>Troubleshooting steps</i>
	<ol style="list-style-type: none"><li>1. Be sure external monitor is compatible with the computer.</li><li>2. Be sure that external monitor is turned on.</li><li>3. Press any key to exit the power-saving mode.</li><li>4. Adjust the brightness of the monitor.</li><li>5. Test with a verified working monitor.</li><li>6. Test the monitor via internal ports (VGA, DP ports).</li><li>7. Install latest video driver.</li><li>8. Reset the screen resolution as described in the documentation.</li><li>9. Configure display choice, and then force output to external video by closing the notebook lid or pressing <b>fn + f4</b> to switch screen output.</li></ol>

## DisplayPort/VGA

Use this information to troubleshoot DisplayPort and VGA issues.

See [No video \(external\) on page 112](#).

## HDMI

Use this information to troubleshoot HDMI issues.

**Table 7-30 Issues, possible causes, and fixes**

Items	Procedures
<i>Symptoms</i>	<i>Possible causes</i>
<ul style="list-style-type: none"><li>• Display issue</li><li>• Sound issue</li></ul>	Cable, connection, settings.
	<i>Troubleshooting steps</i>
	<b>Quick Check</b>
	<ol style="list-style-type: none"><li>1. Verify that the HDMI device input source is set correctly (for example, HDMI1).</li><li>2. Be sure you are using the correct HDMI cable.</li><li>3. Check connection and reconnect the HDMI cable.</li><li>4. Verify whether sound output is configured correctly in <b>Control Panel &gt; Sound Manager</b>.</li></ol>
	<ol style="list-style-type: none"><li>1. Perform hard reset (<a href="#">4. Update BIOS and drivers on page 81</a>).</li><li>2. Update BIOS and drivers (<a href="#">4. Update BIOS and drivers on page 81</a>) when you hear sound but do not see video on HDTV.</li></ol>
<b>References</b>	<a href="http://support.hp.com/us-en/document/c01186408">http://support.hp.com/us-en/document/c01186408</a>

## No or bad external video via docking

Use this information to troubleshoot video issues while docking.

**Table 7-31 Issues, possible causes, and fixes**

Items	Procedures
<i>Symptoms</i>	<i>Possible causes</i>
No or bad image on external monitor via ports of docking station (such as VGA, DP, TB, display port, and others)	Rooted from system board, software or drivers, dock connectors, docking station hardware or firmware, dock video ports (DP, VGA, and others).
	<i>Troubleshooting steps</i>
	<ol style="list-style-type: none"><li>1. Be sure that external monitor is turned on.</li><li>2. Be sure that external monitor is compatible with the computer.</li><li>3. If applicable, plug the dock in different Type-C ports.  For more information, see the technical white paper titled "HP Elite Dock with Thunderbolt 3 &amp; HP ZBook Dock with Thunderbolt 3." Go to <a href="http://www.hp.com/">http://www.hp.com/</a> and search for HP ZBook Thunderbolt 3 Dock User Guide.</li><li>4. If the screen image is distorted, try a DP-to-VGA adapter. Connect the adapter to each DisplayPort and VGA port of the dock.</li><li>5. Test the monitor via internal ports (such as VGA, DP, HDMI, and others).</li><li>6. Verify that dock connectors of the notebook and the dock are clean, without dust, debris (for example, using air duster).</li></ol>

**Table 7-31 Issues, possible causes, and fixes (continued)**

Items	Procedures
	<ol style="list-style-type: none"> <li>Ideally, use a verified working operating system or system connected to the dock to isolate the issue of the current operating system.</li> <li>Ideally, use a verified working docking station to isolate the faulty dock.</li> <li>Update latest dock firmware. Follow the installation instructions carefully. You may want to try a DP-to-VGA adapter if you have a distorted screen image. Connect the adapter to each DisplayPort of the dock. If you still cannot update the dock, attempt to update it on a confirmed working notebook before having the dock replaced.</li> </ol>
<b>Note</b>	See the technical white paper titled "Multiple displays on HP ZBook Mobile Workstations" from HP platform support website. Go to <a href="http://h20195.www2.hp.com/v2/getpdf.aspx/4aa5-2657enw">http://h20195.www2.hp.com/v2/getpdf.aspx/4aa5-2657enw</a> .

## Incorrect or missing color/distorted image

Use this information to troubleshoot image issues.

**Table 7-32 Issues, possible causes, and fixes**

Items	Procedures
<i>Symptoms</i>	<i>Possible causes</i>
System works normally but the display shows:	Loose connection, display cable, display, graphics card.
<ul style="list-style-type: none"> <li>Missing or strange color</li> <li>Image distortion</li> </ul>	<i>Troubleshooting steps</i> <b>Verify with external monitor</b> <ol style="list-style-type: none"> <li>Use combination <b>fn + f4</b> to enable output to external monitor.</li> <li>Close the lid.</li> </ol> <p>If the external monitor also shows incorrect color, it is graphics card issue. Test with a verified working graphics card.</p>
	<b>Verify monitor cable and cable connection</b> (Monitor disassembly is required.) <p>Be sure the monitor cables are not pinched or damaged.</p> <p>Be sure the monitor cables have good connection at both ends (system board and display panel).</p> <ul style="list-style-type: none"> <li>If moving cables affects the image, the monitor cable is the cause of the issue. Test with a confirmed working cable.</li> <li>If moving cables does not affect the image, the monitor has an issue. Test with a confirmed working monitor.</li> </ul>

## Touch screen

Use this information to troubleshoot touch screen issues.

**Table 7-33 Issues, possible causes, and fixes**

Items	Procedures
<i>Symptoms</i>	<i>Possible causes</i>
Unresponsive	Dirt and smudge, driver, touch display configuration, power management.

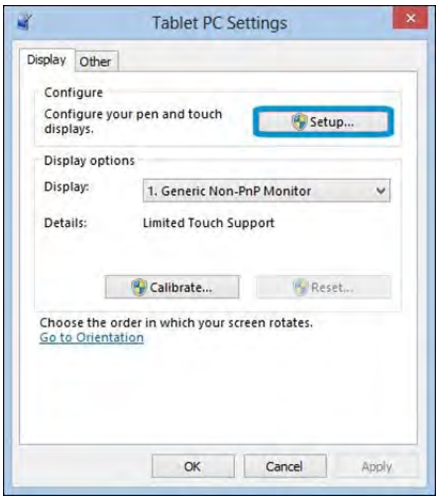

**Table 7-33 Issues, possible causes, and fixes (continued)**

Items	Procedures
Inaccurate	<p><i>Troubleshooting steps</i></p> <p><b>Quick check</b></p> <p>Turn off the computer, spray glass cleaner onto a soft, damp cloth, and gently wipe the screen to remove dirt and smudge.</p> <p><b>NOTE:</b> Do not spray cleaner directly onto the screen.</p>
<p>Configure the touch display in <b>Control Panel &gt; Tablet PC Settings</b></p> 	<ol style="list-style-type: none"><li>1. Restart the computer.</li><li>2. Verify touch screen and graphics drivers.</li><li>3. Configure the touch display to identify the screen as a touch screen as shown in the image at left.</li><li>4. Calibrate the screen and reset if touch functionality is still not working correctly.</li><li>5. Perform diagnostic test in HP Hardware Diagnostics under <b>Component Tests &gt; Touch Screen</b>.  If the diagnostics tests pass but the touch screen still does not respond, continue following the steps.</li><li>6. Adjust the power management settings for your touch screen.  If the touch screen stops working after waking from sleep, adjust the power management settings so that the touch screen device stays active while the computer is in Sleep mode.</li><li>7. Perform Microsoft System Restore, and restore to a time when the system was working.</li><li>8. Perform HP System Recovery if none of the previous actions resolve the issue.</li></ol>
<b>References</b>	<a href="https://support.hp.com/us-en/document/c03488148">https://support.hp.com/us-en/document/c03488148</a>

## I/O devices

Use this information to troubleshoot I/O device issues.



**NOTE:**

- Be sure that external devices are supported and compliant (for example, USB Type-C®, Thunderbolt 3, PCI Express).
- If you have problems with external devices not provided by HP, contact device manufacturers for compatibility and latest drivers before troubleshooting (for example, USB devices, Thunderbolt devices, PCI express card reader, VGA, display, HDMI monitors, speakers).
- Be sure I/O devices are properly inserted into the I/O ports, and then be sure that Windows Device Manager recognizes the I/O devices.

## Keyboard

Use this information to troubleshoot keyboard issues.

**Table 7-34 Issues, possible causes, and fixes**

Items	Procedures
<i>Symptoms</i>	<i>Possible causes</i>
Keystrokes not recognized	Dust trapped under keycap, loose keycap, loose keyboard connection, defective keyboard.
Characters not matched	
	<i>Troubleshooting steps</i>
	<ol style="list-style-type: none"> <li>1. Inspect the keyboard for any signs of dust, liquid, or debris trapped under sticky keys that might prevent keystroke recognition.</li> <li>2. Check for incomplete connection between keyboard and system board by verifying that <b>caps lock</b> or <b>num lk</b> light turns on when you press the key.</li> <li>3. Verify whether the keyboard is recognized in Windows Device Manager, and verify whether the keyboard driver is installed properly.</li> <li>4. Test with a working external keyboard (such as a USB keyboard).  Also test in Windows for special keys (<b>caps lock</b>, <b>shift</b>, <b>ctrl</b>, <b>fn</b>, <b>Windows</b>, <b>alt</b>) if necessary.</li> <li>5. Test with HP PC Hardware Diagnostics (UEFI) to isolate a hardware issue from a software issue.</li> <li>6. Verify that BIOS is up to date. If so, resetting BIOS to default may help.</li> <li>7. Test with a verified working operating system, or restore the operating system to be sure that the issue is not caused by items such as different language settings, sticky keys feature, and so on.</li> <li>8. Verify that keyboard flex cables are fully inserted and in good condition.</li> </ol>
<b>The following steps are for authorized providers and technicians.</b>	
	<ol style="list-style-type: none"> <li>1. Verify whether keyboard flex cable is in good condition (no delamination or torn cable end, no missing or cracked tracks, pads).</li> <li>2. Verify that keyboard flex cable ends are fully inserted and aligned with connectors on system board, and those connector tabs are properly closed. Reseat cables.</li> <li>3. Replace new internal keyboard and retest.</li> </ol>
<b>Tips</b>	If a key works only when pressed with force, inspect and remove debris trapped under keycap.

## Keyboard pointing stick (select products only)

Use this information to troubleshoot pointing stick issues.

**Table 7-35 Issues, possible causes, and fixes**

Items	Procedures
<i>Symptom</i>	<i>Possible causes</i>
Point stick not working properly	Dust trapped under point stick, loose point stick cap.
	<i>Troubleshooting steps</i>
	<ol style="list-style-type: none"> <li>1. Inspect for any signs of dust or liquid spill that prevents point stick from working.</li> <li>2. Check whether point stick cap is loose, and reseat it if necessary.</li> </ol>

**Table 7-35 Issues, possible causes, and fixes (continued)**

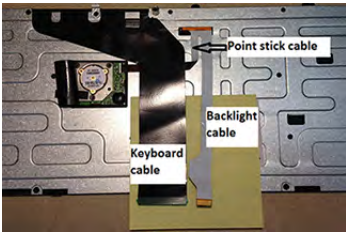
Items	Procedures
<b>The following steps are for authorized providers and technicians.</b>	
	<ol style="list-style-type: none"><li>1. Verify whether keyboard flex cables are in good condition (no delamination or torn cable end, no missing or cracked tracks, pads).</li><li>2. Verify that keyboard flex cable ends are fully inserted and aligned with connectors on system board and back of keyboard, and that connector tabs are properly closed.</li><li>3. Reseat point stick cables.</li></ol>
Example of back of keyboard, including keyboard, point stick, and backlight cables.	

## Keyboard backlight

Use this information to troubleshoot keyboard backlight issues.

**Table 7-36 Issues, possible causes, and fixes**

Items	Procedures
<i>Symptom</i>	<i>Possible causes</i>
Backlight function not working properly	Backlight disabled, loose connection.
	<i>Troubleshooting steps</i>
	<b>NOTE:</b> Not all notebook computers have backlit keyboards. A keyboard function key lets you turn the light on and off. Verify whether backlit feature is not disabled by pressing a combination of <b>fn + backlit</b> key.
<b>The following steps are for authorized providers or technicians.</b>	
	<ol style="list-style-type: none"><li>1. Verify whether backlight flex cables are in good condition (no delamination or torn cable end, no missing or cracked tracks or pads).</li><li>2. Verify that backlight flex cable ends are fully inserted and aligned with connectors on system board and that connector tabs are properly closed.</li><li>3. Reseat backlight cable.</li></ol>

## Touchpad

Use this information to troubleshoot touchpad issues.

**Table 7-37 Issues, possible causes, and fixes**

Items	Procedures
<i>Symptoms</i>	<i>Possible causes</i>
Not working properly	Touchpad turned off, driver, settings.
<b>(1)</b> Touchpad on/off button	<i>Troubleshooting steps</i>

**Table 7-37 Issues, possible causes, and fixes (continued)**

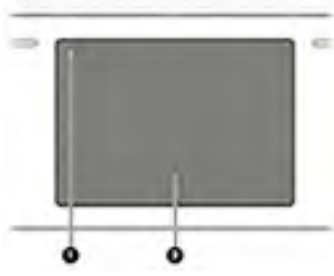
Items	Procedures
<p>(2) Touchpad</p> 	<ol style="list-style-type: none"> <li>1. Ensure touchpad on/off light is not amber (disabled). Double tap to enable.</li> <li>2. Verify whether touchpad device is listed in <b>Device Manager &gt; Mice and other pointing devices</b>.</li> <li>3. Install the latest touchpad driver.</li> <li>4. Adjust touchpad settings (<b>Control Panel &gt; Mouse</b>).</li> <li>5. Test touchpad controller using the HP PC Hardware Diagnostics (UEFI) tool (<b>f2 &gt; Component Tests &gt; Mouse Test &gt; Pointer Test &amp; Drag and Drop Test</b>).</li> </ol>
<p><b>The following steps are for authorized service providers/technicians.</b></p>	
	<ol style="list-style-type: none"> <li>1. Check the touchpad cable for damage or a loose connection, and then reseat the touchpad cable.</li> <li>2. If issue persists, replace the touchpad and verify the change.</li> </ol>

## Network connectivity (RJ-45 jack)

Use this information to troubleshoot network issues.

**Table 7-38 Issues, possible causes, and fixes**

Items	Procedures
<p><i>Symptoms</i></p> <ul style="list-style-type: none"> <li>• Unable to find networks (yellow bang)</li> <li>• Connection dropouts</li> <li>• Slow performance</li> </ul>	<p><i>Possible causes</i></p> <p>Network source, cable, connection, RJ-45 (network) jack, driver, settings.</p>
	<p><i>Troubleshooting steps</i></p> <p><b>Quick Check:</b> verify the network status lights that supposed to flash when there is network activity.</p>

## Network connectivity wireless (WLAN)

Use this information to troubleshoot wireless connectivity issues.

**Table 7-39 Issues, possible causes, and fixes**

Items	Procedures
<p><i>Symptoms</i></p> <ul style="list-style-type: none"> <li>• Unable to find networks (yellow bang)</li> <li>• Connection dropouts</li> <li>• Slow performance</li> </ul>	<p><i>Possible causes</i></p> <p>Network source, cable, connection, wireless module, driver, settings.</p>

**Table 7-39 Issues, possible causes, and fixes (continued)**

Items	Procedures
<b>The following steps are for authorized providers or technicians.</b>	
	<ol style="list-style-type: none"> <li>1. Verify that the wireless module and its antenna cables are fully inserted and in good condition (see WLAN module removal and replacement section). Reseat wireless module and antenna connection.</li> <li>2. Verify the module antenna cable connection is not loose.</li> <li>3. Verify that antenna cables are properly connected to the MAIN and AUX terminals (see WLAN module removal and replacement section).</li> </ol>

## WWAN

Use this information to troubleshoot WWAN issues.

**Table 7-40 Issues, possible causes, and fixes**

Items	Procedures
<i>Symptom</i>	<i>Possible causes</i>
Unable to find networks or service	Network source, cable, connection, driver, settings.
	<i>Troubleshooting steps</i>
	<ol style="list-style-type: none"> <li>1. Update to the latest driver and utility.</li> <li>2. Check with network service provider for signal coverage.</li> <li>3. Be sure signal strength is good.</li> <li>4. Be sure that your service is active.</li> </ol>
<b>The following steps are for authorized providers or technicians.</b>	
	<ul style="list-style-type: none"> <li>• Verify module and antenna cable connections are not loose.</li> <li>• Verify antenna cables are properly connected to the correct terminals. For example, the antenna cable labeled <b>1</b> connects to the Main terminal labeled <b>1</b>. The antenna cable labeled <b>2</b> connects to the Aux terminal labeled <b>2</b>.</li> </ul>

## USB

Use this information to troubleshoot USB port issues.

**Table 7-41 Issues, possible causes, and fixes**

Items	Procedures
<i>Symptoms</i>	<i>Possible causes</i>
<ul style="list-style-type: none"> <li>• USB devices are not recognized</li> <li>• USB devices are not charging</li> </ul>	USB devices do not have the latest software drivers or port insufficient power, or the devices are not compliant.  <b>NOTE:</b> USB Type-C uses a different connector entirely.
Examples of USB device Not Recognized	<i>Troubleshooting steps</i>

**Table 7-41 Issues, possible causes, and fixes (continued)**

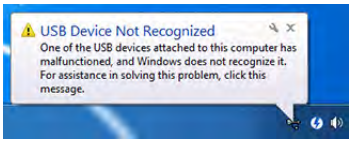
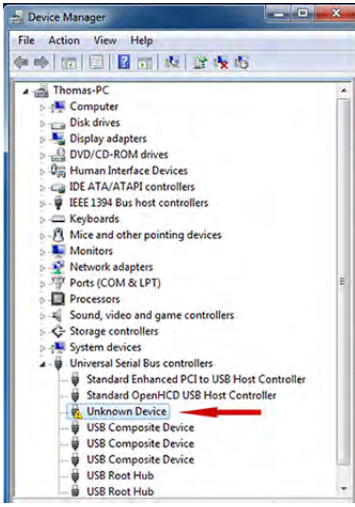
Items	Procedures
 	<ol style="list-style-type: none"> <li>1. Unplug the USB device. Restart the computer (wait for 2–5 minutes) to reset the USB port or hub in case of a power surge.</li> <li>2. Perform a soft reset (9. Soft reset (Default Settings) on page 89), and verify if the USB device is recognized.</li> <li>3. Verify whether the USB device is recognized in <b>Device Manager &gt; Universal Serial Bus Controller</b>, or the USB is recognized without a yellow warning symbol, or bang.</li> <li>4. Verify whether the latest USB driver, USB chipset driver, or both are installed. You can remove or reinstall the USB driver.</li> <li>5. Be sure the USB device is supported, for example, USB 3.0 device requires more power draw (0.9 A) from a USB port than a USB 2.0 device (0.5 A). As a result, identify the USB charging port to be used for charging a USB device, or an external AC power adapter might be required for an external USB storage device to work properly.</li> <li>6. Test with verified working USB devices (keyboard, mouse, USB key) to be sure USB ports are functional.</li> <li>7. Test the USB device on a verified working computer to be sure the USB device is not malfunctioning.</li> </ol>

## Smart card reader

Use this information to troubleshoot smart card reader issues.

**Table 7-42 Issues, possible causes, and fixes**

Items	Procedures
<p><i>Symptoms</i></p> <ul style="list-style-type: none"> <li>• Not recognized</li> <li>• Unable to write</li> </ul>	<p><i>Possible causes</i></p> <p>Physical damage, incorrect insertion, dirt, driver, malfunctioning card reader.</p> <p><b>NOTE:</b> Some cards have a read-write security switch on the card. Be sure that switch is set to Write Enabled before attempting to write data to it.</p>
<p>Card Reader Removal Policy</p>	<p><i>Troubleshooting steps</i></p> <ol style="list-style-type: none"> <li>1. Verify card reader removal policy.</li> <li>2. Make sure there is no physical damage to the card.</li> <li>3. Inspect the ends of the memory cards for dirt or material closing a hole or spoiling a metal contact. Clean the contacts with a lint-free cloth and small amounts of isopropyl alcohol. Replace the memory card if necessary.</li> <li>4. Reinstall and update the drivers for the card reader.</li> <li>5. Make sure the smart card reader is compliant with ISO 7816 Class A, B, and C.</li> <li>6. Reinsert the card reader with correct face as described in its documentation.</li> <li>7. Check reader function with a verified working card.</li> </ol>

**Table 7-42 Issues, possible causes, and fixes (continued)**

Items	Procedures
	

**IMPORTANT:** If the card reader has an in-use indicator light, do not insert or remove memory cards while the light is flashing. Doing so might cause loss of data on the card or might permanently damage the card reader.

## Speaker, headphone - audio issues

Use this information to troubleshoot audio issues.

**Table 7-43 Issues, possible causes, and fixes**

Items	Procedures
<i>Symptoms</i>	<i>Possible causes</i>
<ul style="list-style-type: none"><li>No sound from external or internal speakers</li><li>Distorted sound, too soft, too loud, intermittent</li></ul>	Volume turned down, sound card not recognized, malfunctioning hardware, electronic interference.

### *Troubleshooting steps*

1. Remove any device connected to the audio jack to enable the internal speaker.
2. Close all open programs.
3. Adjust volume by pressing **fn + f6** or **f7**. Be sure that volume button light is not amber (mute).  
- or -  
Adjust Windows volume control by clicking the speaker icon on the Windows taskbar. Be sure that the sound is not muted.
4. Verify that the sound card is detected in Windows Device Manager.
5. Reinstall the **latest audio driver**.
6. Test audio device using HP PC Hardware Diagnostics (UEFI) tool (**f2 > Component Tests > Audio**).
7. Test with a verified working operating system. If issue is resolved, restore full operating system.
8. Test with verified working external speakers or headset.
9. Reseat internal speaker connections.

**Table 7-43 Issues, possible causes, and fixes (continued)**

Items	Procedures
	<ol style="list-style-type: none"> <li>10. Test with verified working internal speakers.</li> <li>11. Replace internal speakers.</li> </ol>
No sound from headphones	<ol style="list-style-type: none"> <li>1. Adjust volume by pressing <b>fn + f6</b> or <b>f7</b>. Be sure that volume button light is not amber (mute). Or adjust Windows volume control by clicking the speaker icon on the Windows taskbar. Be sure that the sound it not muted.</li> <li>2. Check headphone cable connection.</li> <li>3. Test with a verified working audio board.</li> <li>4. Replace audio board and verify the change.</li> </ol>
No sound from external speakers	<ol style="list-style-type: none"> <li>1. Verify that external speakers are turned on.</li> <li>2. Disconnect headphones from headphone jack.</li> <li>3. Adjust volume by pressing <b>fn + f6</b> or <b>f7</b>. Be sure that volume button light is not amber (mute).  - or - Adjust Windows volume control by clicking the speaker icon on the Windows taskbar. Be sure that the sound is not muted.</li> <li>4. Check for possible interference devices nearby that might affect the audio (cell phone or portable communications handset.)</li> </ol>

## Thunderbolt (TB)

Use this information to troubleshoot Thunderbolt issues.

**Table 7-44 Issues, possible causes, and fixes**

Items	Procedures
<i>Symptom</i>	<i>Possible causes</i>
Thunderbolt device not working	BIOS, drivers, and user settings.
	<i>Troubleshooting steps</i>
	<ol style="list-style-type: none"> <li>1. Update to the latest BIOS and choose appropriate TB Port settings.</li> <li>2. Reset <b>User Account Settings</b> to default.</li> <li>3. Update Intel Thunderbolt software that includes firmware version (for TB controller), driver version (operating system driver), and application version.</li> </ol>

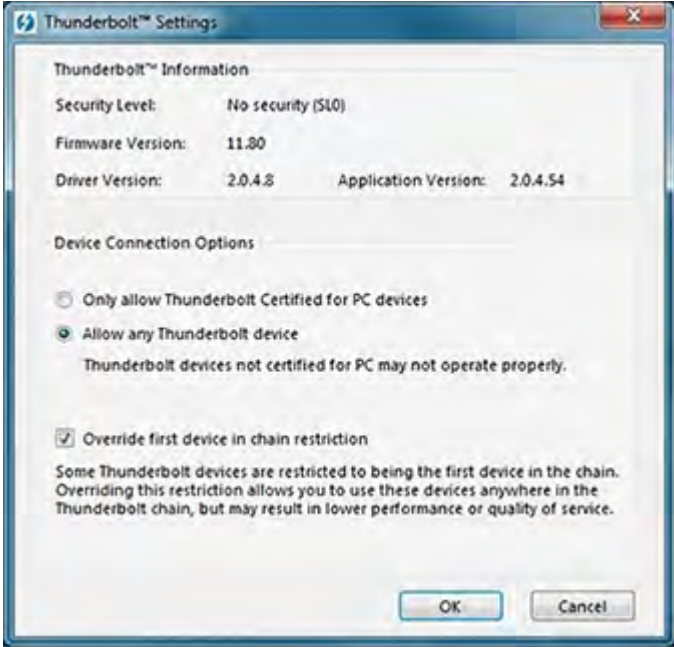

**Table 7-44 Issues, possible causes, and fixes (continued)**

Items	Procedures
	<ol style="list-style-type: none"><li>4. Verify that Windows Device Manager detects the TB device.</li><li>5. Verify cable connection to TB port.</li><li>6. Test with a verified working TB board, if possible.</li></ol>
	<p><b>NOTE:</b> Thunderbolt is new technology. Thunderbolt cable and Thunderbolt device must be compatible with Windows. To determine whether your device is Thunderbolt Certified for Windows, see <a href="https://thunderbolttechnology.net/products">https://thunderbolttechnology.net/products</a>.</p>

## Storage

Use this information to troubleshoot storage issues.



**NOTE:**

- Back up all critical data before troubleshooting the drive.
- Before contacting support, HP recommends that you run a drive (HDD, SSD, M.2 drive) test using the HP PC Hardware Diagnostics (UEFI) tool on the suspected failed drive.
- Diagnose the hard drive using BIOS, Diagnostics built in the shipping image, or an external USB ([http://www8.hp.com/us/en/campaigns/hpsupportassistant/pc-diags.html?jumpid=va\\_r602\\_us/en/any/pps/pl\\_ot\\_ob\\_ds\\_pd/HP\\_PC\\_Hardware\\_Diagnostics\\_cc/dt](http://www8.hp.com/us/en/campaigns/hpsupportassistant/pc-diags.html?jumpid=va_r602_us/en/any/pps/pl_ot_ob_ds_pd/HP_PC_Hardware_Diagnostics_cc/dt)).
- HP recommends the drive quick test to quickly (less than 10 minutes) identify the malfunctioning drive. If the issue still exists, run Extensive Test (more than 2 hours, or loop mode, which runs until an error occurs).
- If any test fails, record failure code and contact support for instructions about how to order a replacement hard drive.
- If all of the tests pass, the hard drive is not damaged. As a rule, HP will not replace a hard drive under warranty that does not fail the HP Hard Drive Self-Test.
- If there is no physical problem with the hard drive (or memory), then try reinstalling the Windows operating system to troubleshoot the problem.

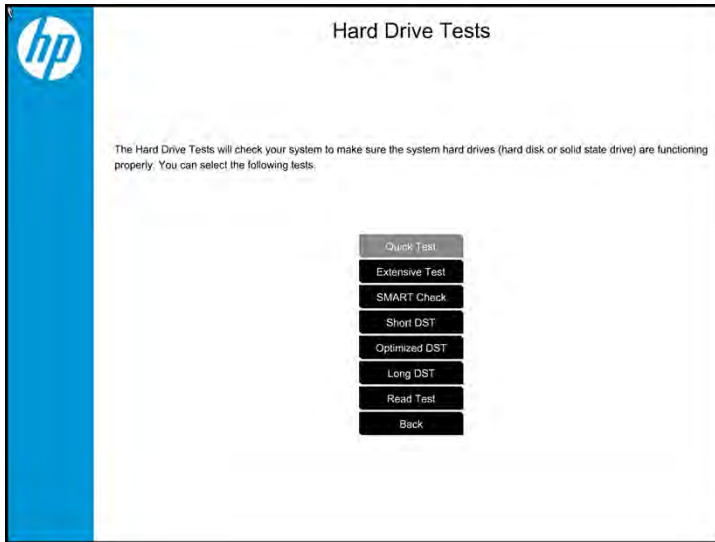

## Hard drive or solid-state drive not recognized

Use this information to troubleshoot storage device issues.

**Table 7-45 Issues, possible causes, and fixes**

Items	Procedures
<i>Symptom</i>	<i>Possible causes</i>
Hard drive is not recognized during POST	Loose connection, faulty hard drive, faulty drive configuration/BIOS setting.
	<i>Troubleshooting steps</i>
	<ol style="list-style-type: none"> <li>1. Perform a hard reset (<a href="#">8. Hard reset on page 88</a>).</li> <li>2. Reset BIOS to default.</li> </ol>

**Table 7-45 Issues, possible causes, and fixes (continued)**

Items	Procedures
	<ol style="list-style-type: none"> <li>Verify hard drive connection and flex cable. Reseat hard drive and cable connection. For multiple storage devices, keep the primary drive with the operating system and remove other devices.</li> <li>Use the HP Hardware Diagnostics tool to verify that the drive is recognized and test it.</li> <li>If the hard drive fails diagnostics, record failure and have the drive replaced.</li> <li>Identify when the issue is related to software. If the hard drive passes diagnostics, test the drive on a verified working computer. If the failure follows the drive, reinstall the operating system to be sure that software is not an issue.</li> <li>Test with a verified working hard drive. If it is still not recognized, the system board is faulty.</li> </ol> <p><b>NOTE:</b> If the drive is seen in BIOS and Diagnostics, try a secure erase before replacing a drive as this might resolve related issues.</p>

## No boot to operating system (no read-write error)

Use this information to troubleshoot issues with booting to the operating system.

**Table 7-46 Issues, possible causes, and fixes**

Items	Procedures
<i>Symptoms</i>	<i>Possible causes</i>
<ul style="list-style-type: none"> <li>POST error message: Boot Device not found (3F0)</li> <li>Hang when booting to operating system</li> </ul>	<p>Operating system, loose connection, faulty hard drive, BIOS configuration, Secure Boot.</p> <hr/> <p><i>Troubleshooting steps</i></p> <ol style="list-style-type: none"> <li>Verify whether Secure Boot is enabled in BIOS. Secure Boot prevents legacy boot devices from starting the computer, including bootable CDs and DVDs. For more information, see <a href="http://support.hp.com/us-en/document/c03653226">http://support.hp.com/us-en/document/c03653226</a>.</li> <li>Reset BIOS to default. Be sure that BIOS <b>Boot Mode</b> in <b>Boot Option</b> is set up properly for bootable device and its operating system (for example, UEFI Native for Windows 8).  Another example, choosing <b>Legacy Boot Order</b> for a UEFI device causes "Boot Device not found (3F0)" error.</li> <li>Verify hard drive connection and flex cable. Reseat connection. For multiple storage devices, keep the primary drive with the operating system and remove other devices.</li> <li>Use PC Hardware Diagnostics tool to test. Record failure code and have the hard drive replaced.</li> <li>If there is no error, reinstall the operating system using HP Restore.</li> <li>Test with a verified working operating system hard drive, if available.</li> </ol>
<b>Note</b>	If there is a hard drive POST error message, see <a href="#">POST error messages and user actions on page 133</a> .

## Read-write error

Use this information to troubleshoot read and write errors.

**Table 7-47 Issues, possible causes, and fixes**

Items	Procedures
<i>Symptoms</i>	<i>Possible causes</i>
<ul style="list-style-type: none"> <li>• POST error message (for example, error code 301)</li> <li>• Hang when working on data, files, documents</li> </ul>	<p>Loose connection, faulty hardware.</p> <hr/> <p><i>Troubleshooting steps</i></p> <ol style="list-style-type: none"> <li>1. Perform a hard reset (<a href="#">8. Hard reset on page 88</a>).</li> <li>2. Reset BIOS to default (<a href="#">9. Soft reset (Default Settings) on page 89</a>).</li> <li>3. Verify the drive connection and flex cable. Reseat connection (<a href="#">10. Reseat cables and connections on page 89</a>).</li> <li>4. Use the HP Hardware Diagnostics tool to test. If failed, record failure code and have the hard drive replaced.</li> <li>5. If no error with HP PC Hardware Diagnostics (UEFI) tool, try to repair the hard drive and its files in Windows (using command “CHKDSK /f /r /x”). Use HP Restore to reinstall the operating system, if needed.</li> <li>6. Test with a verified working hard drive. If it is not recognized, the system board is faulty.</li> </ol>
<b>Note</b>	If there is a hard drive POST error message, see <a href="#">POST error messages and user actions on page 133</a> .

## Blue screen (BSOD) error

A faulty hard drive can cause a blue screen error. Perform the drive tests using the HP Diagnostics Tool to be sure that the drive is functional.

If all of the tests are successful, see [Common blue screen error messages on page 136](#) for detailed troubleshooting steps.

## Noisy hard drive

Use this information to troubleshoot a noisy hard drive.



**IMPORTANT:** Because an SSD has no moving parts, it does not make loud or clicking noises.

Depending on type and rotational speed, some hard drives make more noise than others.

Not all noises are related to the fan or hard drive.

**Table 7-48 Issues, possible causes, and fixes**

Items	Procedures
<i>Symptoms</i>	<i>Possible causes</i>
<ul style="list-style-type: none"> <li>• Loud noise from hard drive</li> <li>• Clicking noise from hard drive</li> <li>• Still boots to operating system and operates normally</li> </ul>	<p>BIOS, hard drive firmware, driver, faulty drive, power supply (AC adapter).</p> <hr/> <p><i>Troubleshooting steps</i></p> <ol style="list-style-type: none"> <li>1. Update BIOS and hard drive firmware.</li> <li>2. Examine AC adapter to be sure that it is not faulty or overloaded. Disconnect all peripherals (USB storages, dock, and others).</li> <li>3. Remove hard drive to isolate the noise.</li> </ol>

**Table 7-48 Issues, possible causes, and fixes (continued)**

Items	Procedures
	<ol style="list-style-type: none"> <li>Test the hard drive on a verified working computer if the noise continues. If the hard drive makes the same noise or clicking sounds, the sounds are either normal sounds for the hard drive or a fault with the hard drive.</li> <li>Verify original hard drive connection and flex cable. Reseat hard drive and connection.</li> <li>Run HP PC Hardware Diagnostics (UEFI). If failed, record failure code and replace hard drive replace.</li> <li>If you find no error with HP PC Hardware Diagnostics (UEFI), perform disk defragmentation. Some hard drives make a clicking noise when highly fragmented.</li> </ol>
<b>Tips</b>	<p>For optimal system performance, place your operating system and all of your most commonly used applications and files on the fastest hard drive or solid-state drive and on the fastest areas on the drive (primary partition of 200 GB max).</p> <p>See <a href="#">Routine maintenance for performance improvement on page 135</a>.</p>

## Mechanical

Use this information to troubleshoot mechanical issues.

### Noise (sound)

Use this information to troubleshoot abnormal noise issues.

**Table 7-49 Issues, possible causes, and fixes**

Items	Procedures
<i>Symptoms</i>	<i>Possible causes</i>
Computer emits abnormal noise	<p>Aside from basic components (power adapter, supply, fan, speaker, hard drive, optical drive, display panel, external devices), it is also common for electronic components to produce noise.</p> <hr/> <p><i>Troubleshooting steps</i></p> <ol style="list-style-type: none"> <li>Inspect external power source and change to verified working one.</li> <li>Determine whether the noise comes from AC power adapter. Test with a verified working AC adapter.</li> </ol> <hr/> <p>Disconnect external devices and all cables connected to the computer to isolate issue to computer only.</p>
<b>Noisy fan</b>	Determine whether the noise comes from the fan. Disconnect the fan briefly to isolate whether noise originates from fan. If noise is absent with fan disconnected, see <a href="#">Fan runs constantly on page 128</a> .
<b>Noisy hard drive</b>	Determine whether the noise comes from the hard drive. See <a href="#">Noisy hard drive on page 126</a> .
<b>Noisy optical drive</b>	<ol style="list-style-type: none"> <li>Determine whether the noise comes from an optical drive.</li> <li>Remove CD/DVD from the optical drive.</li> </ol>
<b>Noisy speaker</b>	<ol style="list-style-type: none"> <li>Determine whether the noise comes from speaker.</li> <li>Test with a verified working external headset/speaker.</li> </ol>

**Table 7-49 Issues, possible causes, and fixes (continued)**

Items	Procedures
Noisy display	Determine whether the noise comes from display panel (humming noise). Change display frequency settings. See <a href="#">Display on page 109</a> .
<b>The section below is intended for authorized service providers and technicians.</b>	
	<ol style="list-style-type: none"> <li>After disassembling the chassis, inspect components of the interior for excessive wear or damage.</li> <li>If noise issues persist, proceed with process of elimination for battery, AC adapter, or boards.</li> </ol>

## Fan runs constantly

Use this information to troubleshoot a constantly running fan.

**Table 7-50 Issues, possible causes, and fixes**

Items	Procedures
<i>Symptoms</i>	<i>Possible causes</i>
<ul style="list-style-type: none"> <li>Fan never stops running</li> <li>Generates heat</li> <li>Decreased computer performance</li> </ul>	<ul style="list-style-type: none"> <li>BIOS not up to date.</li> <li>Thermal condition (fan, air flow)—fan might not be defective but must run constantly to remove excess heat generated by electrical components.</li> <li>Inappropriate configuration.</li> </ul>
	<i>Troubleshooting steps</i>
	<b>General actions</b>
	<ol style="list-style-type: none"> <li>Verify whether BIOS is set to <b>Fan Always on while on AC Power</b> F10 Setup. When booting the computer, press <b>F10</b> to open Setup, and then select <b>Advanced &gt; Built-In Device Options Menu</b>.</li> <li>Update BIOS and drivers (<a href="#">4. Update BIOS and drivers on page 81</a>) and reset BIOS to default. BIOS can implement new fan characteristics and updates for other components.</li> <li>Perform a hard reset (<a href="#">8. Hard reset on page 88</a>). Performing a hard reset can reset recorded thermal values in memory.</li> </ol>
	<b>Thermal-related issue</b>
	<ol style="list-style-type: none"> <li>Verify that fan is spinning. Reseat fan cable before moving to next step. <ol style="list-style-type: none"> <li>Check fan and connection. Reseat fan cable.</li> <li>Be sure that no obstructions or dust are in heat sink fan, heat sink fin, or vent.</li> <li>Test fan using HP PC Hardware Diagnostics (UEFI) tool (<a href="#">6. HP Hardware Diagnostics and Tools on page 82</a>). Be sure that the fan is not producing loud noise and that fan blades spin correctly.</li> <li>Test with a verified working fan.</li> <li>Replace the fan.</li> </ol> </li> <li>Verify thermal solution <p>Use Thermal Monitor tool (available only to authorized service providers and technicians)(<a href="#">HP Thermal Monitor on page 85</a>) to run stress test (processor and GPU) and verify that thermal sensors are within limits after thermal condition is serviced.</p> </li> </ol>

**Table 7-50 Issues, possible causes, and fixes (continued)**

Items	Procedures
	<p><b>User configuration</b></p> <p>Change Power Options in Windows (for example, choosing <b>Balanced mode</b> instead of <b>High performance</b>). High performance and extensive graphics might cause the fan run constantly to release the heat.</p>
<b>Notes</b>	<p>BIOS currently omits fan presence detection to shorten boot time delay less than four seconds. Therefore, the fan error is generated based on previous boot to operating system that found system fan error.</p> <p>Fan often is part of thermal solution, including heat sink, heat sink fin/muffler, and thermal grease. Fan replacement requires reboot and fan function verification using HP PC Hardware Diagnostics (UEFI) tool.</p> <p>For more information, see the following links:</p> <ul style="list-style-type: none"> <li>• <a href="http://support.hp.com/us-en/document/c01007591">http://support.hp.com/us-en/document/c01007591</a>.</li> <li>• <a href="https://support.hp.com/us-en/document/c01657439">https://support.hp.com/us-en/document/c01657439</a>.</li> </ul>

## Thermal shutdown (hot)

Use this information to troubleshoot a thermal shutdown.

**Table 7-51 Issues, possible causes, and fixes**

Items	Procedures
<i>Symptoms</i>	<i>Possible causes</i>
Similar to fan runs constantly issue ( <a href="#">Fan runs constantly on page 128</a> )	BIOS not up to date, thermal condition (fan, air flow)
<ul style="list-style-type: none"> <li>• System shutdown</li> <li>• Abnormal heat</li> <li>• Continually running fan</li> <li>• Decreased computer performance</li> </ul>	<p><i>Troubleshooting steps</i></p> <ol style="list-style-type: none"> <li>1. Update BIOS and drivers (<a href="#">4. Update BIOS and drivers on page 81</a>) and reset BIOS to default. BIOS can implement new fan characteristics and updates for other component.</li> <li>2. Perform a hard reset (<a href="#">8. Hard reset on page 88</a>). Performing a hard reset can reset recorded thermal values in memory.</li> <li>3. Determine whether you are using a correct AC adapter.</li> <li>4. Be sure to turn power off completely when putting a notebook in a travel bag.</li> </ol>

### Thermal-related issue

1. Verify thermal condition:
  - a. Check fan and connection. Is fan spinning when the system is turned on? Reseat fan cable.
  - b. Be sure that no obstructions or dust are in heat sink fan, fin, or vent.
  - c. Be sure that the notebook is not sitting on a hot surface that blocks vent intakes.
  - d. Test fan using HP PC Hardware Diagnostics (UEFI) tool ([6. HP Hardware Diagnostics and Tools on page 82](#)). Be sure that the fan is not producing a loud noise and that fan blades spin correctly.
  - e. Test with a verified working fan.
  - f. Remove old thermal compound and pads, and replace properly with new pads.
2. Verify thermal solution:

**Table 7-51 Issues, possible causes, and fixes (continued)**

Items	Procedures
	<ul style="list-style-type: none"> <li>Use Thermal Monitor tool (available only to authorized service providers and technicians) to run stress test (processor and GPU), and verify that thermal sensors are within limits after thermal condition is serviced.</li> </ul>
<b>Note</b>	See <a href="https://support.hp.com/us-en/document/c01657439">https://support.hp.com/us-en/document/c01657439</a> .

## Malfunctioning power button

Use this information to troubleshoot a nonworking power button.

**Table 7-52 Issues, possible causes, and fixes**

Items	Procedures
<i>Symptoms</i>	<i>Possible causes</i>
<ul style="list-style-type: none"> <li>Rear power indicator light is on</li> </ul>	Defective keyboard.
<ul style="list-style-type: none"> <li>Does not turn on when power button is pressed</li> </ul>	<i>Troubleshooting steps</i>
<ul style="list-style-type: none"> <li>Automatically turns on</li> </ul>	<b>General actions</b> <ol style="list-style-type: none"> <li>Perform a hard reset (<a href="#">8. Hard reset on page 88</a>).</li> <li>Treat as a defective keyboard.</li> </ol>

## Additional information

The following sections provide additional information that you can use during the troubleshooting process.

### Acronyms

These acronyms are used in this chapter.

**Blue screen (BSOD)**—A Windows error screen that can occur if a problem causes your computer to shut down or restart unexpectedly. When you experience this type of error, you cannot see items such as the Start menu or the taskbar when your computer is turned on. Instead you might see a blue screen with a message that your computer ran into a problem and needs to restart.

**CPU**—Central processing unit

**DIMM**—Dual in-line memory module

**Daughterboard**—Type of circuit board that plugs into or is attached to the system board or similar expansion card to extend its features and services.

**GPU**—Graphics processor unit

**GTS**—General Troubleshooting Step

**HDD**—Hard drive

**KB**—Keyboard

**LVDS**—Low-Voltage Differential Signaling

**MSG**—Maintenance and Service Guide



**mWS**—Mobile Workstations  
**WS**—Workstations  
**OS**—Operating system  
**PC**—Personal computer  
**POST**—Power-On Self-Test  
**SSD**—Solid-state drive  
**TSG**—Troubleshooting Guide  
**UEFI**—Unified Extensible Firmware Interface  
**WLAN**—Wireless local area network  
**WWAN**—Wireless wide area network

## Blinking lights and boot error codes

In some cases, when the host processor is not executing code or does not have the necessary code to drive the display, light blink codes inform you of a problem.

The following information is from the white paper <http://h10032.www1.hp.com/ctg/Manual/c04685655>.

**Table 7-53 Blinking lights and boot error codes**

Blink codes	Error
Amber battery light: blinks 1 Hz continuously	Embedded Controller unable to load firmware
Caps and num lk lights = 1 blink	Processor not executing code
Caps and num lk lights = 2 blinks	BIOS recovery code unable to find valid BIOS recovery image
Caps and num lk lights = 3 blinks	Memory module error
Caps and num lk lights = 4 blinks	Graphics controller error
Caps and num lk lights = 5 blinks	System board error
Caps and num lk lights = 6 blinks	Intel Trusted Execution Technology (TXT) Error
Caps and num lk lights = 7 blinks	Sure Start unable to find valid BIOS Boot Block image
Caps and num lk lights = 8 blinks	Sure Start has identified a problem (Manual Recovery Policy Set)

## Processor not executing code

This computer experienced a problem due to the failure of certain code to execute, resulting in a failed startup of the processor.

The issue could be related to the processor or the system board in the computer. If the processor is socketed, be sure that the processor is seated correctly in the socket. If this error reoccurs, see [General troubleshooting steps on page 78](#).

 **NOTE:** The computer attempts to notify you of this problem through a series of blinking lights. When you attempt to turn on the computer from an Off or Hibernated state, lights associated with the **caps lock** and **num lk** keys both **blink once**, followed by a pause, and then continue in a repeating pattern.

## BIOS recovery code unable to find valid BIOS recovery image

This computer has experienced a problem in locating a valid BIOS image, resulting in a failed startup.

You can resolve this problem by placing a clean copy of the system BIOS on a USB key or in the appropriate hard drive directory and performing a reboot. If this error reoccurs, see [General troubleshooting steps on page 78](#).

---

 **NOTE:** The computer attempts to notify you of this problem through a series of blinking lights. When you attempt to turn on the computer from an Off or Hibernated state, lights associated with the [caps lock](#) and [num lock](#) keys both **blink twice**, followed by a pause, and then continue in a repeating pattern.

---

## Memory module error

This computer has experienced a memory initialization problem resulting in a failed startup. This issue might be related to the memory modules in the computer. You can resolve this problem by ensuring that memory modules are correctly inserted and seated.

If this error reoccurs, you must use a service event to determine the source of the error (memory modules or system board) and take the appropriate corrective action.

---

 **NOTE:** The computer attempts to notify you of this problem through a series of blinking lights. When you attempt to turn on the computer from an Off or Hibernated state, lights associated with the [caps lock](#) and [num lock](#) keys both **blink three times**, followed by a pause, and then continue in a repeating pattern.

---

## Graphics Controller Error (No Controller)

This computer has experienced a graphics controller initialization problem resulting in a failed startup. This issue might be related to the graphics controller in your machine.

You can resolve this problem by ensuring that the graphics controller module is seated correctly in machines with modular graphics. If this error reoccurs, you must use a service event to identify the source of the error and take the appropriate corrective action.

---

 **NOTE:** The computer attempts to notify you of this problem through a series of blinking lights. When you attempt to turn on the computer from an Off or Hibernated state, lights associated with the [caps lock](#) and [num lock](#) keys both **blink four times**, followed by a pause, and then continue in a repeating pattern.

---

## Failure System Board Error

This computer has experienced a system board initialization problem resulting in a failed startup. This issue might be related to the system board in the computer. You must use a service event to identify the source of the error and take the appropriate corrective action.

---

 **NOTE:** The computer attempts to notify you of this problem through a series of blinking lights. When you attempt to turn on the computer from an Off or Hibernated state, lights associated with the [caps lock](#) and [num lock](#) keys both **blink five times**, followed by a pause, and then continue in a repeating pattern.

---

## Intel Trusted Execution Technology (TXT) Error

This computer has experienced a problem related to the Intel Trusted Execution Technology resulting in a failed startup. The error occurs when three situations are true:

- The Intel Trusted Execution Technology (TXT) has been enabled on the computer.
- Policies have been set to prevent startup if the BIOS measurement has changed.
- The BIOS measurement has changed.

For more information about Intel TXT, go to <http://www.intel.com/content/dam/www/public/us/en/documents/white-papers/trusted-execution-technology-security-paper.pdf>.

You must use a service event to resolve this issue.

 **NOTE:** The computer attempts to notify you of this problem through a series of blinking lights. When you attempt to turn on the computer from an Off or Hibernated state, lights associated with the **caps lock** and **num lock** keys both **blink six times**, followed by a pause, and then continue in a repeating pattern.

## Sure Start unable to find valid BIOS Boot Block image

This computer has experienced a problem in locating a valid BIOS image, resulting in a failed startup. You must use a service event to identify the source of the error and take appropriate corrective action.

 **NOTE:** The computer attempts to notify you of this problem through a series of blinking lights. When you attempt to turn on the computer from an Off or Hibernated state, lights associated with the **caps lock** and **num lock** keys both **blink seven times**, followed by a pause, and then continue in a repeating pattern.

## Sure Start has identified a problem (Manual Recovery Policy Set)

This computer has experienced a problem in locating a valid BIOS image, resulting in a failed startup. HP Sure Start normally repairs this type of issue; however, on this computer HP Sure Start has been configured to operate in manual mode key sequence.

To proceed with the repair, press and hold the following keys: **esc + up arrow + down arrow**. To avoid the need for this manual recovery step, set the HP Sure Start recovery policy to automatic. If this error reoccurs, you must use a service event to identify the source of the error and take appropriate corrective action.

 **NOTE:** The computer attempts to notify you of this problem through a series of blinking lights. When you attempt to turn on the computer from an Off or Hibernated state, lights associated with the **caps lock** and **num lk** keys both **blink eight times**, followed by a pause, and then continue in a repeating pattern.

## POST error messages and user actions

Use this information to determine the meaning of POST error messages.

**Table 7-54 POST error messages and user actions to address the error**

Test description	Failure descriptions	Error code	Possible user actions
Product information	Invalid value	00A	Contact support for assistance.
Startup test	Memory module	200	Attempt to reseat the memory module and then repeat the test.  Search <a href="http://www.hp.com/support">http://www.hp.com/support</a> for details about troubleshooting issues related to the memory module.  If the memory module still fails, contact support.
Startup test	Hard Disk 1 SMART	301	Attempt to reseat the hard drive and repeat the test.  The hard disk drive might have failed. Contact support for assistance.
Startup test	Hard Disk 2 SMART	302	The hard drive might have failed. Contact support for assistance.
Startup test	Hard Disk 1 Quick	303	The hard drive might have failed. Contact support for assistance.
Startup test	Hard Disk 2 Quick	304	The hard drive might have failed. Contact support for assistance.
Run-in test	Memory module	200	Attempt to reseat the memory module and then repeat the test.

**Table 7-54 POST error messages and user actions to address the error (continued)**

Test description	Failure descriptions	Error code	Possible user actions
			Search <a href="http://www.hp.com/support">http://www.hp.com/support</a> for details about troubleshooting issues related to the memory module.  If the memory module still fails, contact support.
Run-in test	Hard Disk 1 SMART	301	Attempt to reseal the hard drive and repeat the test.  The hard drive might have failed. Contact support for assistance.
Run-in test	Hard Disk 2 SMART	302	The hard drive might have failed. Contact support for assistance.
Run-in test	Hard Disk 1 Quick	303	The hard drive might have failed. Contact support for assistance.
Run-in test	Hard Disk 2 Quick	304	The hard drive might have failed. Contact support for assistance.
Hard Disk Test	Hard Disk 1 SMART	301	Attempt to reseal the hard drive and repeat the test.  The hard drive might have failed. Contact support for assistance.
Hard Disk Test	Hard Disk 2 SMART	302	The hard drive might have failed. Contact support for assistance.
Hard Disk Test	Hard Disk 1 Quick	303	The hard drive might have failed. Contact support for assistance.
Hard Disk Test	Hard Disk 2 Quick	304	The hard drive might have failed. Contact support for assistance.
Hard Disk Test	Hard Disk 1 Full	305	The hard drive might have failed. Contact support for assistance.
Hard Disk Test	Hard Disk 2 Full	306	The hard drive might have failed. Contact support for assistance.
Boot Device Manager	Boot device not found	3F0	This code indicates a potential problem with the hard drive. Run the hard drive test.  See <a href="https://support.hp.com/emea_africa-en/document/c01443371">https://support.hp.com/emea_africa-en/document/c01443371</a> for more information.
Boot Device Manager	Hard Disk 1 Error	3F1	Indicates a potential problem with the hard drive. Run the hard drive test.  See <a href="https://support.hp.com/emea_africa-en/document/c01443371">https://support.hp.com/emea_africa-en/document/c01443371</a> for more information.
Boot Device Manager	Hard Disk 2 Error	3F2	This code indicates a potential problem with the hard drive. Run the hard drive test.  See <a href="https://support.hp.com/emea_africa-en/document/c01443371">https://support.hp.com/emea_africa-en/document/c01443371</a> for more information.
Boot Device Manager	Hard Disk 1 SMART	301	This code indicates a potential problem with the hard drive. Run the hard drive test.  See <a href="https://support.hp.com/emea_africa-en/document/c01443371">https://support.hp.com/emea_africa-en/document/c01443371</a> for more information.
Boot Device Manager	Hard Disk 2 SMART	302	This code indicates a potential problem with the hard drive. Run the hard drive test.  See <a href="https://support.hp.com/emea_africa-en/document/c01443371">https://support.hp.com/emea_africa-en/document/c01443371</a> for more information.
BIOS Recovery	BIOS Recovery Occurred	500	This message indicates that BIOS recovery was completed successfully. No further action is required.
BIOS Application	BIOS Application Error	501	The BIOS installation might have become corrupted. Download the latest version of the BIOS and install it. See <a href="#">4. Update BIOS and drivers on page 81</a> for more information.  If reinstalling the BIOS fails, contact support for further assistance.

**Table 7-54 POST error messages and user actions to address the error (continued)**

Test description	Failure descriptions	Error code	Possible user actions
CMOS Recovery	CMOS Recovery Occurred	502	This message indicates that CMOS recovery was completed successfully. No further action is required.
Battery Check	Primary Battery Replace	601	This code indicates that the primary battery has very low capacity.  Search <a href="http://www.hp.com/support">http://www.hp.com/support</a> for details about using the HP Support Assistant to verify the battery capacity and, if necessary, order a replacement.
Battery Check	Secondary Battery Replace	602	This indicates that the secondary battery has very low capacity.  Search <a href="http://www.hp.com/support">http://www.hp.com/support</a> for details about using the HP Support Assistant to verify the battery capacity and, if necessary, order a replacement.
Wireless Module	Not installed or responding	701	Reseat the wireless LAN adapter module, if your notebook supports it.  Because seating or reseating a wireless LAN adapter is unique to each computer model.
Fan	Fan not operating correctly	90B	The system fan might be malfunctioning.  For information about troubleshooting heat-related issues, see <a href="http://support.hp.com/us-en/document/c01007591">http://support.hp.com/us-en/document/c01007591</a> .  A hard reset can sometimes restore the system fan to working order. See <a href="https://support.hp.com/us-en/document/c01684768">https://support.hp.com/us-en/document/c01684768</a> for details.  If the system fan continues to malfunction, contact support.

## Routine maintenance for performance improvement

The table presents a summary of the suggested times for performing the routine maintenance tasks that are described in this document.

**Table 7-55 Routine maintenance tasks to improve performance**

Tasks	Weekly	Monthly	Occasionally
Perform a system tune up.	X		
Run Windows Update.	X		
Scan for and remove viruses.	X		
Scan for and remove spyware and adware.	X		
Empty the Recycle Bin.	X		
Delete temporary Internet files.	X		
Back up user files.		X	
Create a restore point.		X	
Defragment the hard drive.		X	
Run Scan Disk.		X	
Clean the exterior of the computer.			X
Close programs that are not being used.			X

**Table 7-55 Routine maintenance tasks to improve performance (continued)**

Tasks	Weekly	Monthly	Occasionally
Prevent programs from loading at startup.			X
Remove rear cover and clean fan blades and vents with compressed air.			X

## Common blue screen error messages

The following sections define blue screen error messages.

### Error message list

For an example of a Bug Check Code Reference, use this image.

For more information, see [https://msdn.microsoft.com/en-us/library/windows/hardware/hh994433\(v=vs.85\).aspx](https://msdn.microsoft.com/en-us/library/windows/hardware/hh994433(v=vs.85).aspx).

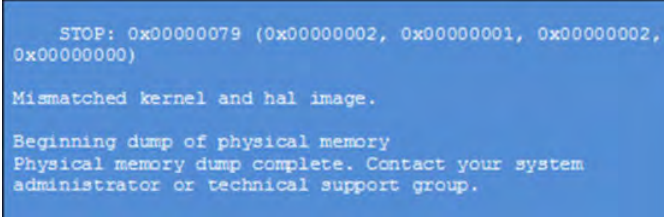

```
STOP: 0x00000079 (0x00000002, 0x00000001, 0x00000002,
0x00000000)

Mismatched kernel and hal image.

Beginning dump of physical memory
Physical memory dump complete. Contact your system
administrator or technical support group.
```

Note that the hexadecimal number following the word "STOP" is called the bug check code or Stop code.

### Bug check symbolic names

Each bug check code also has an associated symbolic name.

In the example, the screen shows [https://msdn.microsoft.com/en-us/library/windows/hardware/ff559209\(v=vs.85\).aspx](https://msdn.microsoft.com/en-us/library/windows/hardware/ff559209(v=vs.85).aspx)

## Microsoft general troubleshooting of Windows bug check codes

Use this information to troubleshoot Windows bug codes.

- If you recently added hardware to the system, try removing or replacing it. Or check with the manufacturer to see if any patches are available.
- Try running HP PC Hardware Diagnostics (UEFI).
- Check with the manufacturer to see if an updated system BIOS or firmware is available.
- Be sure that any expansion board is properly seated and all cables are completely connected.
- Confirm that any new hardware that is installed is compatible with the installed version of Windows.
- If new device drivers or system services have been added recently, try removing or updating them.



**NOTE:** Use safe mode when removing or disabling components. Safe mode loads only the minimum required drivers and system services during the Windows startup. To enter safe mode, restart your computer and press **f8** at the menu that displays the operating system choices. At the resulting **Windows Advanced Options** menu, choose **Safe Mode**.

- Run a virus detection program. Viruses can infect all types of hard drives formatted for Windows, and resulting drive corruption can generate system bug check codes. Be sure that the virus detection program checks the Master Boot Record for infections.
- Verify that the system has the latest service pack installed. To detect which service pack, if any, is installed on your system, click **Start**, click **Run**, type `winver`, and then press **enter**. The **About Windows** dialog box displays the Windows version number and the version number of the service pack, if one has been installed.
- Disable BIOS memory options such as caching or shadowing.
- Check the System Log and Application Log in Event Viewer to see if any additional error messages have been logged recently. These might pinpoint the cause of the error.

## Use Windows Debugging Tool

Debugging Tools for Windows are the primary tools used by Microsoft software developers to analyze and resolve errors that result in memory dumps.

Use the tool ([https://msdn.microsoft.com/library/windows/hardware/ff551063%20\(v=vs.85\).aspx](https://msdn.microsoft.com/library/windows/hardware/ff551063%20(v=vs.85).aspx)) to determine the cause of the error. Follow general steps for downloading, setting up, and using the Windows 10 debugging tool. A similar process is used for Windows 7 or Windows 8.

 **NOTE:** The following screen shots provide only an example of the tool. Specifics shown are not representative of all applications of the debugging tool. This is a Microsoft tool supported by Microsoft.

## Windows Software Development Kit (SDK)

Use these steps to download and use the Windows SDK.

1. Download the SDK from the following link:  
<https://dev.windows.com/en-US/downloads/windows-10-sdk>
2. Set up the SDK in the configuration window (Windows 10 shown).

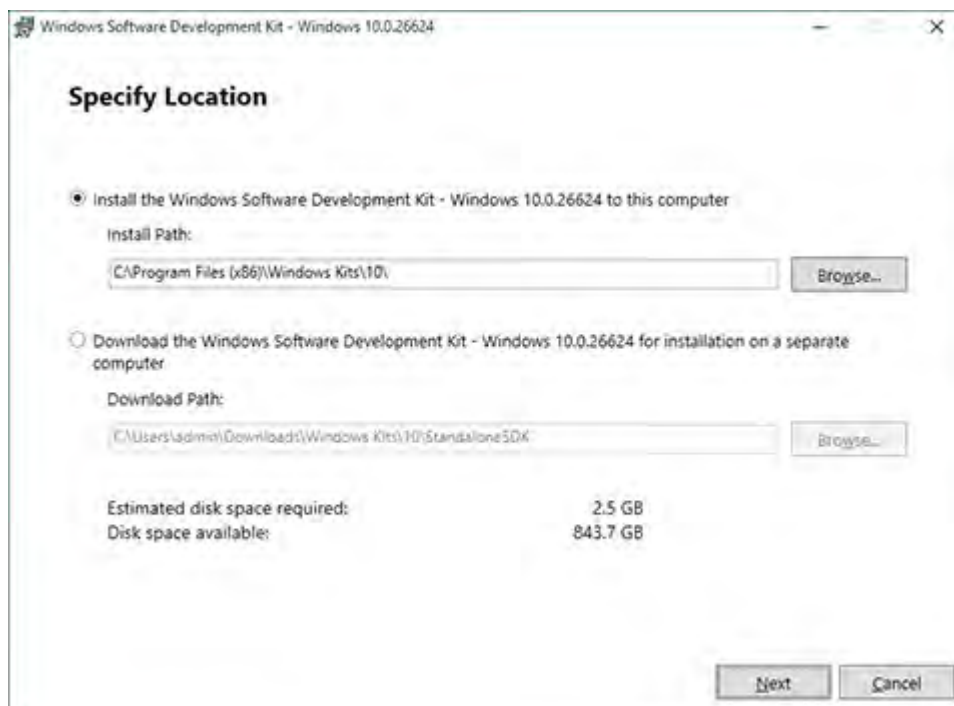

3. Select features to install.

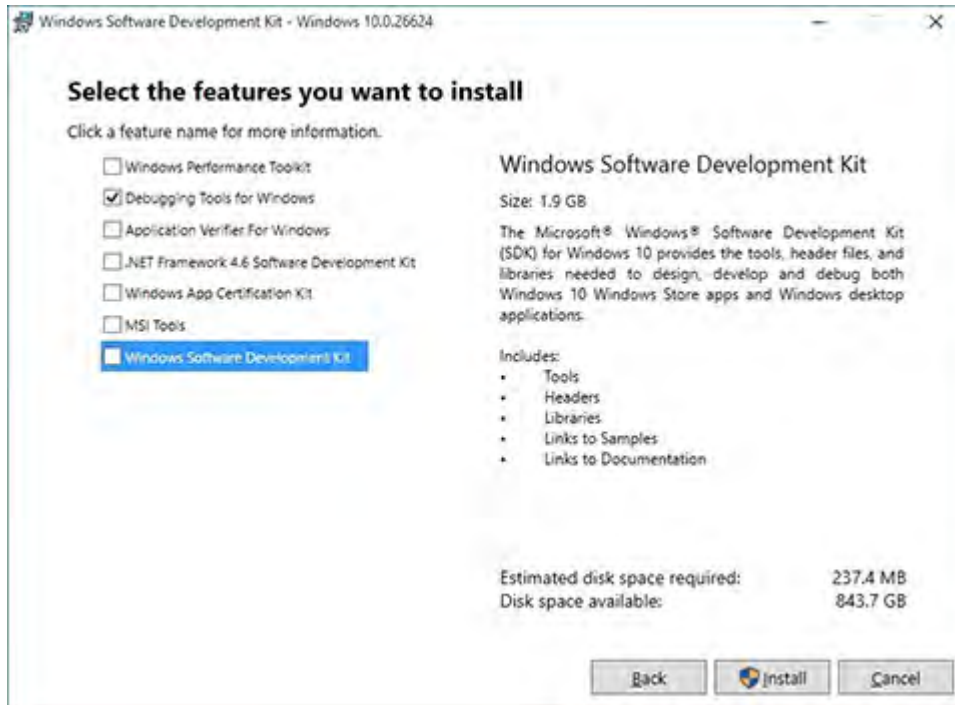

4. Run the SDK as an administrator.



5. Set the symbol path. Select **File > Symbol File Path**.

- In the **Symbol path** box, type `SRV*C:\Windows\symbol_cache*http://msdl.microsoft.com/download/symbols`.
- Save the workspace.



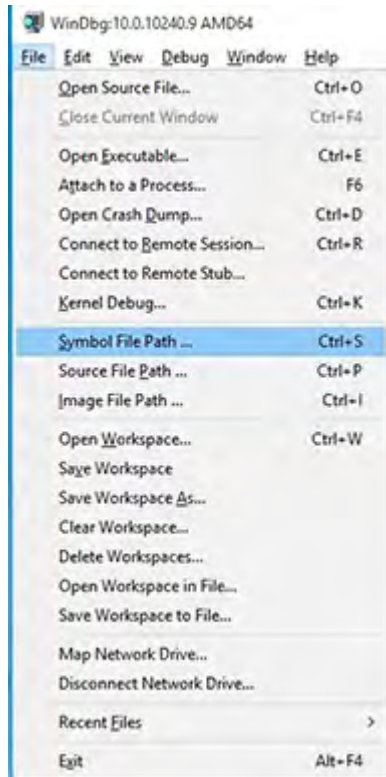

6. Open the crash dump file.

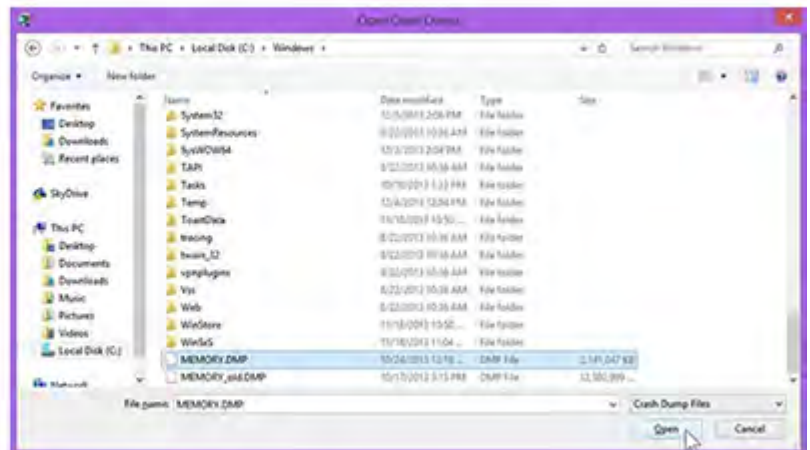

7. Analyze the file. In the following memory dump sample, look for Bug Check 0x3B. The ATKMAG driver needs to be investigated for further root cause.

Lookup for Bug Check 0xC2.

```
1: kd> !analyze -v
.....
*
*                               Bugcheck Analysis
*
*
.....

SYSTEM_SERVICE_EXCEPTION (3b)
An exception happened while executing a system service routine.
Arguments:
Arg1: 00000000c0000005, Exception code that caused the bugcheck
Arg2: fffff8006d927acf, Address of the instruction which caused the bugcheck
Arg3: fffff80020e4e500, Address of the context record for the exception that caused the bugcheck
Arg4: 0000000000000000, zero.

Debugging Details:
.....
BUGCHECK_P1: c0000005
BUGCHECK_P2: fffff8006d927acf
BUGCHECK_P3: fffff80020e4e500
BUGCHECK_P4: 0
EXCEPTION_CODE: (NTSTATUS) 0xc0000005 - The instruction at 0x%p referenced memory at 0x%p. The memory
.....
FAULTING_IP:
atikmag+2facf
fffff8006d927acf 45390c2434030000 cmp     dword ptr [r12+334h],r15o
.....
...

SYMBOL_STACK_INDEX: 0
SYMBOL_NAME: atikmag+2facf
FOLLOWUP_NAME: MachineOwner
MODULE_NAME: atikmag
IMAGE_NAME: atikmag.sys
DEBUG_FLR_IMAGE_TIMESTAMP: 55479b42
STACK_COMMAND: .cxr 0xfffff80020e4e500 ; kb
BUCKET_ID_FUNC_OFFSET: 2facf
FAILURE_BUCKET_ID: 0x3b_atikmag!Unknown_Function
BUCKET_ID: 0x3b_atikmag!Unknown_Function
PRIMARY_PROBLEM_CLASS: 0x3b_atikmag!Unknown_Function
ANALYSIS_SOURCE: KM
FAILURE_ID_HASH_STRING: km:0x3b_atikmag!unknown_function
FAILURE_ID_HASH: {adb8875-801c-005a-68e8-645bb2f2c848}
```

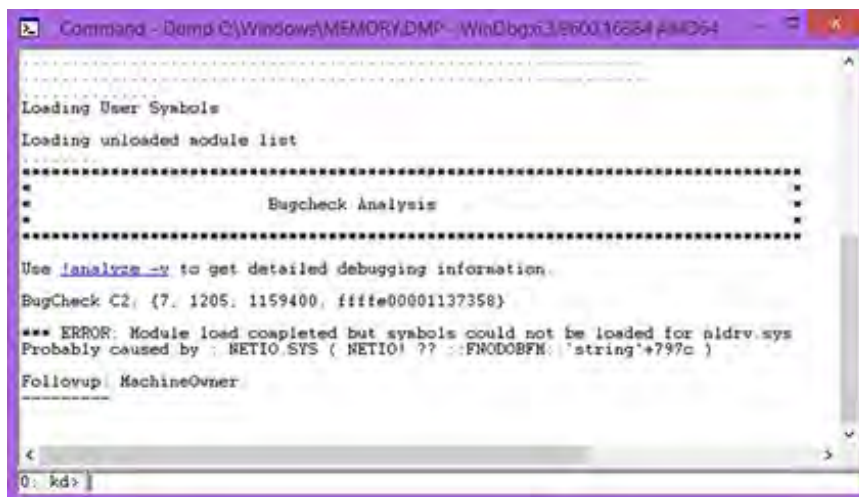

```
Command - Dump C:\Windows\MEMORY.DMP - WinDbg3.1.6601.16864 #AMD64
.....
Loading User Symbols
Loading unloaded module list
.....
*
*                               Bugcheck Analysis
*
*
.....

Use !analyze -v to get detailed debugging information.
BugCheck C2: (7, 1205, 1159400, fffff8001137358)
*** ERROR: Module load completed but symbols could not be loaded for nldr.sys
Probably caused by : NETIO.SYS ( NETIO! ?? -:FNODDBFM: 'string'+79?c )
Followup: MachineOwner
.....
0: kd>
```

## Display issue: pixel anomalies

All HP notebook displays adhere to strict quality and reliability specifications. A small percentage of display panels might have minor cosmetic manufacturing anomalies or irregularities such as bright or dark dots in the viewable area. These cosmetic imperfections are common to all display panel types, not specifically HP products.

All display panel defects should be examined at the highest possible resolution using both the brightest and darkest possible backgrounds, because some subpixel failures might not be readily visible under certain conditions.

- Type 1: Bright dot on a dark background = Always On
- Type 2: Dark dot on a bright background = Always Off
- Combination = in any combination and any color that are always on or off

Use the HP PC Hardware Diagnostics (UEFI) tool to determine numbers of pixels and their distance. HP uses the following set of criteria when damaged displays are submitted for warranty coverage.

Source: <http://support.hp.com/us-en/document/c00035844>

**Table 7-56 Electrical defect criteria**

Panel resolution	Accept	Reject
<b>Subpixel faults</b>		
VGA, SVGA, SD, WSVGA, XGA, 720p, SD+, WXGA, HD	N ≤ 2 Type 1 N ≤ 2 Type 2	N ≥ 3 Type 1
WXGA+, SXGA+, HD+, SXGA+	N ≤ 3 Type 1 N ≤ 3 Type 2	N ≥ 4 Type 1
WSXGA+, UXGA, FHD, WUXGA	N ≤ 4 Type 1 N ≤ 4 Type 2	N ≥ 5 Type 1
QHD, QHD+, WQXGA, UD	N ≤ 5 Type 1 N ≤ 5 Type 2	N ≥ 6 Type 1
<b>Electrical defect clusters (defects within a 5x5 pixel block)</b>		
Minimum distance between ANY allowable defects (unless otherwise specified)	S ≥ 25 mm	S < 25 mm
Cluster with 2 or more subpixels with subpixel faults		Not allowed
Dim lines		Not allowed
Cross lines on/off		Not allowed
Horizontal lines on/off		Not allowed
Vertical lines on/off		Not allowed

 **NOTE:** Examine all LCD panel defects at the highest possible resolution using both the brightest and darkest possible backgrounds, because some subpixel failures might not be readily visible under certain conditions.

 **NOTE:** Contact support for assistance if issues are not listed.

## Cable management

Proper routing of the internal cables is critical to the operation of the computer. Follow good cable management practices when you have to remove and install components.

- Handle cables with care to avoid damage.
- Apply only the tension required to seat or unseat cables during insertion or removal from the connector.

- When possible, handle cables by the connector or pull-strap.
- Route cables in such a way that they cannot be caught or snagged by parts being removed or replaced.
- Keep cables away from direct contact with major heat sources, such as the heat sink. (Some air flow guides have a cable guide that lets you route cables safely around the heat sink.)
- Do not jam cables on top of daughterboards or memory modules (DIMMs). Circuit cards and DIMMs are not designed to take excessive pressure.
- Keep cables clear of any movable or rotating parts (such as a fan) to prevent them from being cut or crimped when the component is lowered into its normal position.
- In all cases, avoid bending or twisting the cables. Do not bend any cable sharply. A sharp bend can break the internal wires.
- Do not rely on components like the keyboard or service door to push cables down internally. Always position the cables to lie properly by themselves or in the cable guides and chassis areas designed for cable routing.

---

 **IMPORTANT:** Always release connector latch before removing the cable. Otherwise, pulling the cable could damage the cable pins and result in a failed device.

---

## Connector types

There are several types of connectors on the system board with different requirements for cable removal or insertion.

---

 **IMPORTANT:** Do not touch connector pins and connector gold fingers directly with bare hands.

---

## Flex cable

Use this information to properly use flex cables.

When connecting flex cables to a ZIF connector, rotate the latch to 90°, push the cable completely, evenly into the connector, and then close the latch.

When removing flex cables from a ZIF connector on the system board, you must release the latch before removing the cable. Always follow these steps:

1. Flip the connector latch 90° to release the cable.
2. Grasp the cable end of the connector and pull it straight out.

---

 **IMPORTANT:** Always release connector latch before removing the cable. Otherwise, pulling the cable could damage the cable pins and result in a failed device.

---

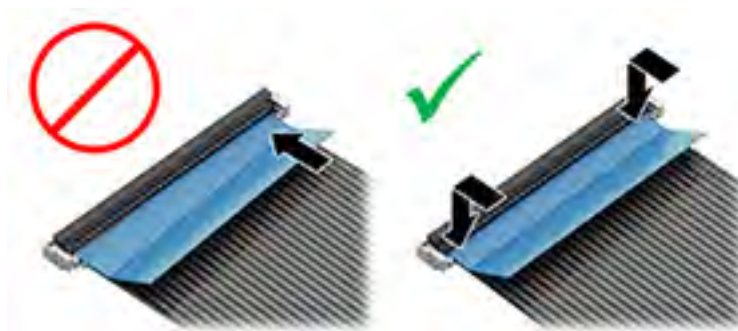

## Horizontal cable insertion

Use flat tool to pull connector evenly. Do not pull on cable to remove.

Slide connector into receptacle on same horizontal plane as board and use a flat tool to push evenly into receptacle.



## Multiple-pin horizontal connector (LVDS cable to display panel)

Use these procedures to properly insert and remove a multiple-pin horizontal connector.

Insert procedure:

1. Slide connector evenly into receptacle on same horizontal plane as PCB connector.
2. Pull lock bar to insert and push both side connector horizontally to firmly lock.
3. Tape down lock bar over the panel to hold in position.

Reverse the previous procedure to remove the connector:

1. Remove tape.
2. Pull up bar (pull tape) and release the lock with the PCB connector.
3. Pull to the direction in parallel with PCB to withdraw the connector.



## Multiple-pin vertical connector (LVDS cable to system board)

Use this procedure to properly insert and remove a multiple-pin vertical connector.

- Remove the connector gasket before removing the connector.
- If the connector has a plastic pull tab, pull the tab to disconnect. Otherwise, use flat tool under the connector to remove evenly. Do not pull on the cable to remove.
- Press evenly when reseating, reconnecting, or installing the connector.



For more information about cable management, see [Cable management on page 141](#).

---

# 8 Computer Setup (BIOS), TPM, and HP Sure Start

HP provides several tools to help set up and protect your computer.

## Using Computer Setup

Computer Setup, or Basic Input/Output System (BIOS), controls communication between all the input and output devices on the system (such as hard drives, display, keyboard, mouse, and printer). Computer Setup includes settings for types of devices installed, the startup sequence of the computer, and amount of system and extended memory.

---

 **NOTE:** Use extreme care when making changes in Computer Setup. Errors can prevent the computer from operating properly.

---

To start Computer Setup, turn on or restart the computer, and when the HP logo appears, press **f10** to enter Computer Setup.

## Navigating and selecting in Computer Setup

You can navigate and select in Computer Setup using one or more methods.

- To select a menu or a menu item, use the **tab** key and the keyboard arrow keys and then press **enter**, or use a pointing device to select the item.
- To scroll up and down, select the up arrow or the down arrow in the upper-right corner of the screen, or use the up arrow key or the down arrow key on the keyboard.
- To close open dialog boxes and return to the main Computer Setup screen, press **esc**, and then follow the on-screen instructions.

To exit Computer Setup, choose one of the following methods:

- To exit Computer Setup menus without saving your changes, select **Main**, select **Ignore Changes and Exit**, and then select **Yes**.

---

 **NOTE:** If you are using arrow keys to highlight your choice, you must then press **enter**.

---

- To save your changes and exit Computer Setup menus, select **Main**, select **Save Changes and Exit**, and then select **Yes**.

---

 **NOTE:** If you are using arrow keys to highlight your choice, you must then press **enter**.

---

Your changes go into effect when the computer restarts.

## Restoring factory settings in Computer Setup

To return all settings in Computer Setup to the values that were set at the factory, follow these steps.

---

 **NOTE:** Restoring defaults will not change the hard drive mode.

---

1. Start Computer Setup. See [Using Computer Setup on page 145](#).
2. Select **Main**, select **Apply Factory Defaults and Exit**, and then select **Yes**.

---

 **NOTE:** If you are using arrow keys to highlight your choice, you must then press [enter](#).

 **NOTE:** On select products, the selections might display **Restore Defaults** instead of **Apply Factory Defaults and Exit**.

---

Your changes go into effect when the computer restarts.

---

 **NOTE:** Your password settings and security settings are not changed when you restore the factory settings.

---

## Updating the BIOS

Updated versions of the BIOS might be available on the HP website. Most BIOS updates on the HP website are packaged in compressed files called *SoftPaqs*.

Some download packages contain a file named *Readme.txt*, which contains information regarding installing and troubleshooting the file.

### Determining the BIOS version

To decide whether you need to update Computer Setup (BIOS), first determine the BIOS version on your computer.

You can access BIOS version information (also known as *ROM date* and *System BIOS*) by pressing [fn+esc](#) (if you are already in Windows) or by using Computer Setup.

1. Start Computer Setup. See [Using Computer Setup on page 145](#).
2. Select **Main**, and then select **System Information**.
3. To exit Computer Setup menus without saving your changes, select **Main**, select **Ignore Changes and Exit**, and then select **Yes**.

---

 **NOTE:** If you are using arrow keys to highlight your choice, you must then press [enter](#).

---

To check for later BIOS versions, see [Preparing for a BIOS update on page 146](#).

### Preparing for a BIOS update

Be sure to follow all prerequisites before downloading and installing a BIOS update.

---

 **IMPORTANT:** To reduce the risk of damage to the computer or an unsuccessful installation, download and install a BIOS update only when the computer is connected to reliable external power using the AC adapter. Do not download or install a BIOS update while the computer is running on battery power, docked in an optional docking device, or connected to an optional power source. During the download and installation, follow these instructions:

Do not disconnect power on the computer by unplugging the power cord from the AC outlet.

Do not shut down the computer or initiate Sleep.

Do not insert, remove, connect, or disconnect any device, cable, or cord.

---

### Downloading a BIOS update

After you review the prerequisites, you can check for and download BIOS updates.



1. Type `support` in the taskbar search box, and then select the HP Support Assistant app.  
– or –  
Select the question mark icon in the taskbar.
2. Select **Updates**, and then select **Check for updates and messages**.
3. Follow the on-screen instructions.
4. At the download area, follow these steps:
  - a. Identify the most recent BIOS update and compare it to the BIOS version currently installed on your computer. Make a note of the date, name, or other identifier. You might need this information to locate the update later, after it has been downloaded to your hard drive.
  - b. Follow the on-screen instructions to download your selection to the hard drive.  
  
Make a note of the path to the location on your hard drive where the BIOS update is downloaded. You will need to access this path when you are ready to install the update.

---

 **NOTE:** If you connect your computer to a network, consult the network administrator before installing any software updates, especially system BIOS updates.

---

### Installing a BIOS update

BIOS installation procedures vary. Follow any instructions that are displayed on the screen after the download is complete. If no instructions are displayed, follow these steps.

1. Type `file` in the taskbar search box, and then select **File Explorer**.
2. Select your hard drive designation. The hard drive designation is typically Local Disk (C:).
3. Using the hard drive path you recorded earlier, open the folder that contains the update.
4. Double-click the file that has an `.exe` extension (for example, `filename.exe`).  
  
The BIOS installation begins.
5. Complete the installation by following the on-screen instructions.

---

 **NOTE:** After a message on the screen reports a successful installation, you can delete the downloaded file from your hard drive.

---

### Changing the boot order using the f9 prompt

To dynamically choose a boot device for the current startup sequence, follow these steps.

1. Access the Boot Device Options menu:
  - Turn on or restart the computer, and when the HP logo appears, press **f9** to enter the Boot Device Options menu.
2. Select a boot device, press `enter`, and then follow the on-screen instructions.

## TPM BIOS settings (select products only)

TPM provides additional security for your computer. You can modify the TPM settings in Computer Setup (BIOS).

---

 **IMPORTANT:** Before enabling Trusted Platform Module (TPM) functionality on this system, you must ensure that your intended use of TPM complies with relevant local laws, regulations and policies, and approvals or licenses must be obtained if applicable. For any compliance issues arising from your operation or usage of TPM that violates the previously mentioned requirement, you shall bear all the liabilities wholly and solely. HP will not be responsible for any related liabilities.

 **NOTE:** If you change the TPM setting to Hidden, TPM is not visible in the operating system.

---

To access TPM settings in Computer Setup:

1. Start Computer Setup. See [Using Computer Setup on page 145](#).
2. Select **Security**, select **TPM Embedded Security**, and then follow the on-screen instructions.

## Using HP Sure Start (select products only)

Select computer models are configured with HP Sure Start, a technology that monitors the computer's BIOS for attacks or corruption. If the BIOS becomes corrupted or is attacked, HP Sure Start automatically restores the BIOS to its previously safe state, without user intervention.

HP Sure Start is configured and already enabled so that most users can use the HP Sure Start default configuration. Advanced users can customize the default configuration.

To access the latest documentation on HP Sure Start, go to <http://www.hp.com/support>. Select **Find your product**, and then follow the on-screen instructions.

---

## 9 Backing up, restoring, and recovering

You can use Windows tools or HP software to back up your information, create a restore point, reset your computer, create recovery media, or restore your computer to its factory state. Performing these standard procedures can return your computer to a working state faster.

---

 **IMPORTANT:** If you will be performing recovery procedures on a tablet, the tablet battery must be at least 70% charged before you start the recovery process.

**IMPORTANT:** For a tablet with a detachable keyboard, connect the tablet to the keyboard base before beginning any recovery process.

---

### Backing up information and creating recovery media

These methods of creating recovery media and backups are available on select products only.

#### Using Windows tools for backing up

HP recommends that you back up your information immediately after initial setup. You can do this task either using Windows Backup locally with an external USB drive or using online tools.

---

 **IMPORTANT:** Windows is the only option that allows you to back up your personal information. Schedule regular backups to avoid information loss.

 **NOTE:** If computer storage is 32 GB or less, Microsoft® System Restore is disabled by default.

---

#### Using the HP Cloud Recovery Download Tool to create recovery media (select products only)

You can use the HP Cloud Recovery Download Tool to create HP Recovery media on a bootable USB flash drive.

For details:

- ▲ Go to <http://www.hp.com/support>, search for HP Cloud Recovery, and then select the result that matches the type of computer that you have.

---

 **NOTE:** If you cannot create recovery media yourself, contact support to obtain recovery discs. Go to <http://www.hp.com/support>, select your country or region, and then follow the on-screen instructions.

 **IMPORTANT:** HP recommends that you follow the [Restoring and recovery methods on page 150](#) to restore your computer before you obtain and use the HP recovery discs. Using a recent backup can return your machine to a working state sooner than using the HP recovery discs. After the system is restored, reinstalling all the operating system software released since your initial purchase can be a lengthy process.

---

### Restoring and recovering your system

You have several tools available to recover your system both within and outside of Windows if the desktop cannot load.

HP recommends that you attempt to restore your system using the [Restoring and recovery methods on page 150](#).

## Creating a system restore

System Restore is available in Windows. The System Restore software can automatically or manually create restore points, or snapshots, of the system files and settings on the computer at a particular point.

When you use System Restore, it returns your computer to its state at the time you made the restore point. Your personal files and documents should not be affected.

## Restoring and recovery methods

After you run the first method, test to see whether the issue still exists before you proceed to the next method, which might now be unnecessary.

1. Run a Microsoft System Restore.
2. Run Reset this PC.

---

 **NOTE:** The options **Remove everything** and then **Fully clean the drive** can take several hours to complete and leave no information on your computer. It is the safest way to reset your computer before you recycle it.

---

3. Recover using HP Recovery media. For more information, see [Recovering using HP Recovery media on page 150](#).

For more information about the first two methods, see the Get Help app:

Select the **Start** button, select the **Get Help** app, and then enter the task you want to perform.

---

 **NOTE:** You must be connected to the internet to access the Get Help app.

---

## Recovering using HP Recovery media

You can use HP Recovery media to recover the original operating system and software programs that were installed at the factory. On select products, it can be created on a bootable USB flash drive using the HP Cloud Recovery Download Tool.

For details, see [Using the HP Cloud Recovery Download Tool to create recovery media \(select products only\) on page 149](#).

---

 **NOTE:** If you cannot create recovery media yourself, contact support to obtain recovery discs. Go to <http://www.hp.com/support>, select your country or region, and then follow the on-screen instructions.

---

To recover your system:

- ▲ Insert the HP Recovery media, and then restart the computer.

---

 **NOTE:** HP recommends that you follow the [Restoring and recovery methods on page 150](#) to restore your computer before you obtain and use the HP recovery discs. Using a recent backup can return your machine to a working state sooner than using the HP recovery discs. After the system is restored, reinstalling all the operating system software released since your initial purchase can be a lengthy process.

---

## Changing the computer boot order

If your computer does not restart using the HP Recovery media, you can change the computer boot order, the order of devices listed in BIOS for startup information. You can select an optical drive or a USB flash drive, depending on the location of your HP Recovery media.

---

 **IMPORTANT:** For a tablet with a detachable keyboard, connect the tablet to the keyboard base before beginning these steps.

---

To change the boot order:

1. Insert the HP Recovery media.
2. Access the system **Startup** menu.
  - For computers or tablets with keyboards attached, turn on or restart the computer or tablet, quickly press **esc**, and then press **f9** for boot options.
  - For tablets without keyboards, turn on or restart the tablet, quickly press and hold the volume up button, and then select **f9**.  
– or –  
Turn on or restart the tablet, quickly press and hold the volume down button, and then select **f9**.
3. Select the optical drive or USB flash drive from which you want to boot, and then follow the on-screen instructions.

## Using HP Sure Recover (select products only)

Select computer models are configured with HP Sure Recover, a PC operating system (OS) recovery solution built into the hardware and software. HP Sure Recover can fully restore the HP OS image without installed recovery software.

Using HP Sure Recover, an administrator or user can restore the system and install:

- Latest version of the operating system
- Platform-specific device drivers
- Software applications, in the case of a custom image

To access the latest documentation for HP Sure Recover, go to <http://www.hp.com/support>. Follow the on-screen instructions to find your product and locate your documentation.

---

# 10 Using HP PC Hardware Diagnostics

You can use the HP PC Hardware Diagnostics utility to determine whether your computer hardware is running properly. The three versions are HP PC Hardware Diagnostics Windows, HP PC Hardware Diagnostics UEFI (Unified Extensible Firmware Interface), and (for select products only) Remote HP PC Hardware Diagnostics UEFI, a firmware feature.

## Using HP PC Hardware Diagnostics Windows (select products only)

HP PC Hardware Diagnostics Windows is a Windows-based utility that allows you to run diagnostic tests to determine whether the computer hardware is functioning properly. The tool runs within the Windows operating system to diagnose hardware failures.

If HP PC Hardware Diagnostics Windows is not installed on your computer, first you must download and install it. To download HP PC Hardware Diagnostics Windows, see [Downloading HP PC Hardware Diagnostics Windows on page 153](#).

## Using an HP PC Hardware Diagnostics Windows hardware failure ID code

When HP PC Hardware Diagnostics Windows detects a failure that requires hardware replacement, a 24-digit failure ID code is generated for select component tests. For interactive tests, such as keyboard, mouse, or audio and video palette, you must perform troubleshooting steps before you can receive a failure ID.

- ▲ You have several options after you receive a failure ID:
  - Click **Next** to open the Event Automation Service (EAS) page, where you can log the case.  
– or –
  - Scan the QR code with your mobile device, which takes you to the EAS page, where you can log the case.  
– or –
  - Click the box next to the 24-digit failure ID to copy your failure code and send it to support.

## Accessing HP PC Hardware Diagnostics Windows

After HP PC Hardware Diagnostics Windows is installed, you can access it from HP Help and Support, HP Support Assistant, or the Start menu.

## Accessing HP PC Hardware Diagnostics Windows from HP Help and Support (select products only)

After HP PC Hardware Diagnostics Windows is installed, follow these steps to access it from HP Help and Support.

1. Select the **Start** button, and then select **HP Help and Support**.
2. Select **HP PC Hardware Diagnostics Windows**.
3. When the tool opens, select the type of diagnostic test that you want to run, and then follow the on-screen instructions.

---

 **NOTE:** To stop a diagnostic test, select **Cancel**.

---

## Accessing HP PC Hardware Diagnostics Windows from Support Assistant

After HP PC Hardware Diagnostics Windows is installed, follow these steps to access it from HP Support Assistant.

1. Type `support` in the taskbar search box, and then select the **HP Support Assistant** app.  
– or –  
Select the question mark icon in the taskbar.
2. Select **Troubleshooting and fixes**.
3. Select **Diagnostics**, and then select **HP PC Hardware Diagnostics Windows**.
4. When the tool opens, select the type of diagnostic test that you want to run, and then follow the on-screen instructions.

---

 **NOTE:** To stop a diagnostic test, select **Cancel**.

---

## Accessing HP PC Hardware Diagnostics Windows from the Start menu (select products only)

After HP PC Hardware Diagnostics Windows is installed, follow these steps to access it from the Start menu.

1. Select the **Start** button.
2. Right-click **HP PC Hardware Diagnostics for Windows**, select **More**, and then select **Run as administrator**.
3. When the tool opens, select the type of diagnostic test that you want to run, and then follow the on-screen instructions.

---

 **NOTE:** To stop a diagnostic test, select **Cancel**.

---

## Downloading HP PC Hardware Diagnostics Windows

The HP PC Hardware Diagnostics Windows downloading instructions are provided in English only. You must use a Windows computer to download this tool because only .exe files are provided.

### Downloading the latest HP PC Hardware Diagnostics Windows version from HP

To download HP PC Hardware Diagnostics Windows from HP, follow these steps.

1. Go to <http://www.hp.com/go/techcenter/pcdiags>. The HP PC Diagnostics home page is displayed.
2. Select **Download HP Diagnostics Windows**, and then select the specific Windows diagnostics version to download to your computer or a USB flash drive.

The tool downloads to the selected location.

### Downloading the HP PC Hardware Diagnostics Windows from the Microsoft Store

You can download the HP PC Hardware Diagnostics Windows from the Microsoft Store.

1. Select the Microsoft Store app on your desktop or enter `Microsoft Store` in the taskbar search box.
2. Enter `HP PC Hardware Diagnostics Windows` in the **Microsoft Store** search box.
3. Follow the on-screen directions.

The tool downloads to the selected location.

## Downloading HP Hardware Diagnostics Windows by product name or number (select products only)

You can download HP PC Hardware Diagnostics Windows by product name or number.

---

 **NOTE:** For some products, you might have to download the software to a USB flash drive by using the product name or number.

---

1. Go to <http://www.hp.com/support>.
2. Select **Software and Drivers**, select your type of product, and then enter the product name or number in the search box that is displayed.
3. In the **Diagnostics** section, select **Download**, and then follow the on-screen instructions to select the specific Windows diagnostics version to be downloaded to your computer or USB flash drive.

The tool downloads to the selected location.

## Installing HP PC Hardware Diagnostics Windows

To install HP PC Hardware Diagnostics Windows, navigate to the folder on your computer or the USB flash drive where the .exe file downloaded, double-click the .exe file, and then follow the on-screen instructions.

## Using HP PC Hardware Diagnostics UEFI

HP PC Hardware Diagnostics UEFI (Unified Extensible Firmware Interface) allows you to run diagnostic tests to determine whether the computer hardware is functioning properly. The tool runs outside the operating system so that it can isolate hardware failures from issues that are caused by the operating system or other software components.

---

 **NOTE:** For Windows 10 S computers, you must use a Windows computer and a USB flash drive to download and create the HP UEFI support environment because only .exe files are provided. For more information, see [Downloading HP PC Hardware Diagnostics UEFI to a USB flash drive on page 155](#).

---

If your PC does not start in Windows, you can use HP PC Hardware Diagnostics UEFI to diagnose hardware issues.

## Using an HP PC Hardware Diagnostics UEFI hardware failure ID code

When HP PC Hardware Diagnostics UEFI detects a failure that requires hardware replacement, a 24-digit failure ID code is generated.

For assistance in solving the problem:

- ▲ Select **Contact HP**, accept the HP privacy disclaimer, and then use a mobile device to scan the failure ID code that appears on the next screen. The HP Customer Support - Service Center page appears with your failure ID and product number automatically filled in. Follow the on-screen instructions.

– or –

Contact support, and provide the failure ID code.

---

 **NOTE:** To start diagnostics on a convertible computer, your computer must be in notebook mode, and you must use the attached keyboard.

---

 **NOTE:** If you need to stop a diagnostic test, press `esc`.

---



## Starting HP PC Hardware Diagnostics UEFI

To start HP PC Hardware Diagnostics UEFI, follow this procedure.

1. Turn on or restart the computer, and quickly press `esc`.
2. Press `f2`.

The BIOS searches three places for the diagnostic tools, in the following order:

- a. Connected USB flash drive



---

**NOTE:** To download the HP PC Hardware Diagnostics UEFI tool to a USB flash drive, see [Downloading the latest HP PC Hardware Diagnostics UEFI version on page 155](#).

---

- b. Hard drive

- c. BIOS

3. When the diagnostic tool opens, select a language, select the type of diagnostic test you want to run, and then follow the on-screen instructions.

## Downloading HP PC Hardware Diagnostics UEFI to a USB flash drive

Downloading HP PC Hardware Diagnostics UEFI to a USB flash drive can be useful in some situations.

- HP PC Hardware Diagnostics UEFI is not included in the preinstallation image.
- HP PC Hardware Diagnostics UEFI is not included in the HP Tool partition.
- The hard drive is damaged.



---

**NOTE:** The HP PC Hardware Diagnostics UEFI downloading instructions are provided in English only, and you must use a Windows computer to download and create the HP UEFI support environment because only .exe files are provided.

---

## Downloading the latest HP PC Hardware Diagnostics UEFI version

To download the latest HP PC Hardware Diagnostics UEFI version to a USB flash drive, follow this procedure.

1. Go to <http://www.hp.com/go/techcenter/pcdiags>. The HP PC Diagnostics home page is displayed.
2. Select **Download HP Diagnostics UEFI**, and then select **Run**.

## Downloading HP PC Hardware Diagnostics UEFI by product name or number (select products only)

You can download HP PC Hardware Diagnostics UEFI by product name or number (select products only) to a USB flash drive.



---

**NOTE:** For some products, you might have to download the software to a USB flash drive by using the product name or number.

---

1. Go to <http://www.hp.com/support>.
2. Enter the product name or number, select your computer, and then select your operating system.
3. In the **Diagnostics** section, follow the on-screen instructions to select and download the specific UEFI Diagnostics version for your computer.

# Using Remote HP PC Hardware Diagnostics UEFI settings (select products only)

Remote HP PC Hardware Diagnostics UEFI is a firmware (BIOS) feature that downloads HP PC Hardware Diagnostics UEFI to your computer. It can then execute the diagnostics on your computer, and it might upload results to a preconfigured server.

For more information about Remote HP PC Hardware Diagnostics UEFI, go to <http://www.hp.com/go/techcenter/pcdiags>, and then select **Find out more**.

## Downloading Remote HP PC Hardware Diagnostics UEFI

HP Remote PC Hardware Diagnostics UEFI is also available as a SoftPaq that you can download to a server.

### Downloading the latest Remote HP PC Hardware Diagnostics UEFI version

You can download the latest HP PC Hardware Diagnostics UEFI version to a USB flash drive.

1. Go to <http://www.hp.com/go/techcenter/pcdiags>. The HP PC Diagnostics home page is displayed.
2. Select **Download Remote Diagnostics**, and then select **Run**.

### Downloading Remote HP PC Hardware Diagnostics UEFI by product name or number

You can download HP Remote PC Hardware Diagnostics UEFI by product name or number.



---

**NOTE:** For some products, you might have to download the software by using the product name or number.

1. Go to <http://www.hp.com/support>.
2. Select **Software and Drivers**, select your type of product, enter the product name or number in the search box that is displayed, select your computer, and then select your operating system.
3. In the **Diagnostics** section, follow the on-screen instructions to select and download the **Remote UEFI** version for the product.

## Customizing Remote HP PC Hardware Diagnostics UEFI settings

Using the Remote HP PC Hardware Diagnostics setting in Computer Setup (BIOS), you can perform several customizations.

- Set a schedule for running diagnostics unattended. You can also start diagnostics immediately in interactive mode by selecting **Execute Remote HP PC Hardware Diagnostics**.
- Set the location for downloading the diagnostic tools. This feature provides access to the tools from the HP website or from a server that has been preconfigured for use. Your computer does not require the traditional local storage (such as a hard drive or USB flash drive) to run remote diagnostics.
- Set a location for storing the test results. You can also set the user name and password that you use for uploads.
- Display status information about the diagnostics run previously.

To customize Remote HP PC Hardware Diagnostics UEFI settings, follow these steps:

1. Turn on or restart the computer, and when the HP logo appears, press **f10** to enter Computer Setup.
2. Select **Advanced**, and then select **Settings**.

3. Make your customization selections.
  4. Select **Main**, and then **Save Changes and Exit** to save your settings.
- Your changes take effect when the computer restarts.

# 11 Specifications

This chapter provides specifications for your computer.

## Computer specifications

This section provides specifications for your computer. When traveling with your computer, the computer dimensions and weights, as well as input power ratings and operating specifications, provide helpful information.

**Table 11-1 Computer specifications**

	Metric	U.S.
<b>Dimensions</b>		
Width	<b>323.4 mm</b>	12.73 in
Depth	<b>214.6 mm</b>	8.45 in
Height (400 nits and above, nontouch)	<b>17.95 mm</b>	0.71 in
Height (250 nits, nontouch or touch)	<b>19.2 mm</b>	0.76 in
<b>Weight</b>		
400 nit nontouch panel	<b>1.41 kg</b>	3.1 lbs
250 nit touch panel	<b>1.55 kg</b>	3.41 lbs
<b>Input power</b>		
Operating voltage and current	19.5 V dc @ 2.31 A – 45 W	
	19.5 V dc @ 3.33 A – 65 W	
<b>Temperature</b>		
Operating	<b>5°C to 35°C</b>	41°F to 95°F
Nonoperating	<b>-20°C to 60°C</b>	-4°F to 140°F
<b>Relative humidity</b> (noncondensing)		
Operating	10% to 90%	
Nonoperating	5% to 95%	
<b>Maximum altitude</b> (unpressurized)		
Operating	<b>-15 m to 3,048 m</b>	-50 ft to 10,000 ft
Nonoperating	<b>-15 m to 12,192 m</b>	-50 ft to 40,000 ft
<b>NOTE:</b> Applicable product safety standards specify thermal limits for plastic surfaces. The device operates well within this range of temperatures.		

## 35.6 cm (14.0 in) display specifications

This section provides specifications for your display.

**Table 11-2 Display specifications**

	<b>Metric</b>	<b>U.S.</b>
Active diagonal size	<b>35.6 cm</b>	14.0 in
Resolution	1920 × 1080	
Surface treatment	Antiglare	
Brightness	250 nits (45% CG panels, touch and nontouch) 400 nits (sRGB 100% panels) 1000 nits (72% CG panels)	
Viewing angle	UWVA	
Backlight	LED	
Display panel interface	eDP	

## Solid-state drive specifications

This section provides specifications for your solid-state drives.

**Table 11-3 Solid-state drive specifications**

	<b>128 GB*</b>	<b>256 GB*</b>	<b>512 GB*</b>	<b>1 TB*</b>	<b>2 TB*</b>
<b>Dimensions</b>					
Height	1.0 mm	1.0 mm	1.0 mm	1.0 mm	1.0 mm
Length	50.8 mm	50.8 mm	50.8 mm	50.8 mm	50.8 mm
Width	28.9 mm	28.9 mm	28.9 mm	28.9 mm	28.9 mm
Weight	< 10 g	< 10 g	< 10 g	< 10 g	< 10 g
<b>Interface type</b>	PCIe	PCIe	PCIe	PCIe	PCIe
Ready time, maximum (to not busy)	1.0 ms	1.0 ms	< 1.0 ms	1.0 ms	1.0 ms
Access times, logical	1.0 ms	0.1 ms	0.1 ms	0.1 ms	0.1 ms
<b>Transfer rate</b>					
Sequential read	up to 2150 MB/s	up to 2150 MB/s	up to 2150 MB/s	up to 2150 MB/s	up to 2150 MB/s
Random read	Up to 300,000 IOPs	Up to 300,000 IOPs	Up to 300,000 IOPs	Up to 300,000 IOPs	Up to 300,000 IOPs
Sequential write	up to 1550 MB/s	up to 1550 MB/s	up to 1550 MB/s	up to 1550 MB/s	up to 1550 MB/s
Random write	Up to 100,000 IOPs	Up to 100,000 IOPs	Up to 100,000 IOPs	Up to 100,000 IOPs	Up to 100,000 IOPs
<b>Total logical sectors</b>	234,441,648	468,883,296	1,000,215,216	1,500,336,388	3,000,672,776

**Table 11-3 Solid-state drive specifications (continued)**

	128 GB*	256 GB*	512 GB*	1 TB*	2 TB*
<b>Operating temperature</b>	0°C to 70°C (32°F to 158°F)				
*1 GB = 1 billion bytes when referring to hard drive storage capacity. Actual accessible capacity is less. Actual drive specifications can differ slightly.					
<b>NOTE:</b> Certain restrictions and exclusions apply. Contact support for details.					

---

## 12 Statement of memory volatility

For general information regarding nonvolatile memory in HP business computers, and to restore nonvolatile memory that can contain personal data after the system has been turned off and the hard drive has been removed, use these instructions.

HP business computer products that use Intel®-based or AMD®-based system boards contain volatile DDR memory. The amount of nonvolatile memory present in the system depends upon the system configuration. Intel-based and AMD-based system boards contain nonvolatile memory subcomponents as originally shipped from HP, with the following assumptions:

- No subsequent modifications were made to the system.
- No applications, features, or functionality were added to or installed on the system.

Following system shutdown and removal of all power sources from an HP business computer system, personal data can remain on volatile system memory (DIMMs) for a finite period of time and also remains in nonvolatile memory. Use the following steps to remove personal data from the computer, including the nonvolatile memory found in Intel-based and AMD-based system boards.

---

 **NOTE:** If your tablet has a keyboard base, connect to the keyboard base before beginning steps in this chapter.

---

### Current BIOS steps

Use these instructions to restore nonvolatile memory.

1. Follow these steps to restore the nonvolatile memory that can contain personal data. Restoring or reprogramming nonvolatile memory that does not store personal data is neither necessary nor recommended.
  - a. Turn on or restart the computer, and then quickly press **esc**.

---

 **NOTE:** If the system has a BIOS administrator password, enter the password at the prompt.
  - b. Select **Main**, select **Apply Factory Defaults and Exit**, and then select **Yes** to load defaults. The computer restarts.
  - c. During the restart, press **esc** while the "Press the ESC key for Startup Menu" message is displayed at the bottom of the screen.

---

 **NOTE:** If the system has a BIOS administrator password, enter the password at the prompt.
  - d. Select the **Security** menu, select **Restore Security Settings to Factory Defaults**, and then select **Yes** to restore security level defaults. The computer reboots.
  - e. During the reboot, press **esc** while the "Press the ESC key for Startup Menu" message is displayed at the bottom of the screen.

---

 **NOTE:** If the system has a BIOS administrator password, enter the password at the prompt.
  - f. If an asset or ownership tag is set, select the **Security** menu and scroll down to the **Utilities** menu. Select **System IDs**, and then select **Asset Tracking Number**. Clear the tag, and then make the selection to return to the prior menu.

- g. If a DriveLock password is set, select the **Security** menu, and scroll down to **Hard Drive Utilities** under the **Utilities** menu. Select **Hard Drive Utilities**, select **DriveLock**, and then clear the check box for **DriveLock password on restart**. Select **OK** to proceed.
- h. Select the **Main** menu, and then select **Reset BIOS Security to factory default**. Select **Yes** at the warning message. The computer reboots.
- i. During the reboot, press **esc** while the "Press the ESC key for Startup Menu" message is displayed at the bottom of the screen.



---

**NOTE:** If the system has a BIOS administrator password, enter the password at the prompt.

---

- j. Select the **Main** menu, select **Apply Factory Defaults and Exit**, select **Yes** to save changes and exit, and then select **Shutdown**.
  - k. Reboot the system. If the system has a Trusted Platform Module (TPM), fingerprint reader, or both, one or two prompts will appear—one to clear the TPM and the other to Reset Fingerprint Sensor. Press or tap **f1** to accept or **f2** to reject.
  - l. Remove all power and system batteries for at least 24 hours.
2. Complete one of the following:
- Remove and retain the storage drive.  
– or –
  - Clear the drive contents by using a third-party utility designed to erase data from an SSD.  
– or –
  - Clear the contents of the drive by using the following BIOS Setup Secure Erase command option steps:

If you clear data using Secure Erase, you cannot recover it.

- a. Turn on or restart the computer, and then quickly press **esc**.
- b. Select the **Security** menu and scroll down to the **esc** menu.
- c. Select **Hard Drive Utilities**.
- d. Under **Utilities**, select **Secure Erase**, select the hard drive storing the data you want to clear, and then follow the on-screen instructions to continue.

– or –

Clear the contents of the drive using the following Disk Sanitizer commands steps:

- i. Turn on or restart the computer, and then quickly press **esc**.
- ii. Select the **Security** menu and scroll down to the **Utilities** menu.
- iii. Select **Hard Drive Utilities**.
- iv. Under **Utilities**, select **Disk Sanitizer**, select the hard drive with the data that you want to clear, and then follow the on-screen instructions to continue.



---

**NOTE:** The amount of time it takes for Disk Sanitizer to run can take several hours. Plug the computer into an AC outlet before starting.

---



# Nonvolatile memory usage

Use this table to troubleshooting nonvolatile memory usage.

**Table 12-1 Troubleshooting steps for nonvolatile memory usage**

Nonvolatile memory type	Amount (Size)	Does this memory store customer data?	Does this memory retain data when power is removed?	What is the purpose of this memory?	How is data entered into this memory?	How is this memory write-protected?
HP Sure Start flash (select models only)	8 MB	No	Yes	Provides protected backup of critical System BIOS code, EC firmware, and critical computer configuration data for select platforms that support HP Sure Start.  For more information, see <a href="#">Using HP Sure Start (select products only) on page 166.</a>	Data cannot be written to this device via the host processor. The content is managed solely by the HP Sure Start Embedded Controller.	This memory is protected by the HP Sure Start Embedded Controller.
Real Time Clock (RTC) battery backed-up CMOS configuration memory	256 bytes	No	Yes	Stores system date and time and noncritical data.	RTC battery backed-up CMOS is programmed using Computer Setup (BIOS), or by changing the Windows date & time.	This memory is not write-protected.
Controller (NIC) EEPROM	64 KB (not customer accessible)	No	Yes	Stores NIC configuration and NIC firmware.	NIC EEPROM is programmed using a utility from the NIC vendor that can be run from DOS.	A utility must be used to write data to this memory and is available from the NIC vendor. Writing data to this ROM in an inappropriate manner will render the NIC non-functional.
DIMM Serial Presence Detect (SPD) configuration data	256 bytes per memory module, 128 bytes programmable (not customer accessible)	No	Yes	Stores memory module information.	DIMM SPD is programmed by the memory vendor.	Data cannot be written to this memory when the module is installed in a computer. The specific write-protection method varies by memory vendor.
System BIOS	9 MB	Yes	Yes	Stores system BIOS code and computer configuration data.	System BIOS code is programmed at the factory. Code is updated when the system BIOS is updated. Configuration data and settings are entered using the Computer Setup (BIOS) or a custom utility.	<b>NOTE:</b> Writing data to this ROM in an inappropriate manner can render the computer non-functional.  A utility must be used for writing data to this memory and is available

**Table 12-1 Troubleshooting steps for nonvolatile memory usage (continued)**

Nonvolatile memory type	Amount (Size)	Does this memory store customer data?	Does this memory retain data when power is removed?	What is the purpose of this memory?	How is data entered into this memory?	How is this memory write-protected?
Intel Management Engine Firmware (present only in select Elite or Z models. For more information, go to <a href="http://www.hp.com/support">http://www.hp.com/support</a> . Select <b>Identify your product for manuals and specific product information</b> , and then follow the on-screen instructions.)	1.5 MB or 7 MB	Yes	Yes	Stores Management Engine Code, Settings, Provisioning Data and iAMT third-party data store.	Management Engine Code is programmed at the factory. Code is updated via Intel secure firmware update utility. Unique Provisioning Data can be entered at the factory or by an administrator using the Management Engine (MEBx) setup utility. The third-party data store contents can be populated by a remote management console or local applications that have been registered by an administrator to have access to the space.	on the HP website; go to <a href="http://www.hp.com/support">http://www.hp.com/support</a> . Select <b>Find your product</b> , and then follow the on-screen instructions.
Bluetooth flash (select products only)	2 megabits	No	Yes	Stores Bluetooth configuration and firmware.	Bluetooth flash is programmed at the factory. Tools for writing data to this memory are not publicly available but can be obtained from the silicon vendor.	A utility must be used for writing data to this memory and is made available through newer versions of the driver whenever the flash requires an upgrade.
802.11 WLAN EEPROM	4 kilobits to 8 kilobits	No	Yes	Stores configuration and calibration data.	802.11 WLAN EEPROM is programmed at the factory. Tools for writing data to this memory are not made public.	A utility must be used for writing data to this memory and is typically not made available to the public unless a firmware upgrade is necessary to address a unique issue.
Camera (select products only)	64 kilobits	No	Yes	Stores camera configuration and firmware.	Camera memory is programmed using a utility from the device manufacturer that can be run from Windows.	A utility must be used for writing data to this memory and is typically not made available to the public unless a firmware upgrade is necessary to address a unique issue.
Fingerprint reader (select products only)	512 KB flash	Yes	Yes	Stores fingerprint templates.	Fingerprint reader memory is programmed by user enrollment in HP ProtectTools Security Manager.	Only a digitally signed application can make the call to write to the flash.

# Questions and answers

Use this section to answer your questions about nonvolatile memory.

## 1. How can the BIOS settings be restored (returned to factory settings)?



**IMPORTANT:** The restore defaults feature does not securely erase any information on your hard drive. See question and answer 6 for steps to securely erase information.

The restore defaults feature does not reset the Custom Secure Boot keys. See question and answer 7 for information about resetting the keys.

- a. Turn on or restart the computer, and then quickly press `esc`.
  - b. Select **Main**, and then select **Apply Factory Defaults and Exit**.
  - c. Follow the on-screen instructions.
  - d. Select **Main**, select **Save Changes and Exit**, and then follow the on-screen instructions.
- ## 2. What is a UEFI BIOS, and how is it different from a legacy BIOS?

The Unified Extensible Firmware Interface (UEFI) BIOS is an industry-standard software interface between the platform firmware and an operating system (OS). It replaces the older BIOS architecture but supports much of the legacy BIOS functionality.

Like the legacy BIOS, the UEFI BIOS provides an interface to display the system information and configuration settings and to change the configuration of your computer before an OS is loaded. BIOS provides a secure runtime environment that supports a Graphic User Interface (GUI). In this environment, you can use either a pointing device (touch screen, touchpad, pointing stick, or USB mouse) or the keyboard to navigate and make menu and configuration selections. The UEFI BIOS also contains basic system diagnostics.

The UEFI BIOS provides functionality beyond that of the legacy BIOS. In addition, the UEFI BIOS works to initialize the computer's hardware before loading and executing the OS; the runtime environment allows the loading and execution of software programs from storage devices to provide more functionality, such as advanced hardware diagnostics (with the ability to display more detailed system information) and advanced firmware management and recovery software.

HP has provided options in Computer Setup (BIOS) to allow you to run in legacy BIOS, if required by the operating system. Examples of this requirement would be if you upgrade or downgrade the OS.

## 3. Where is the UEFI BIOS located?

The UEFI BIOS is located on a flash memory chip. You must use a utility to write to the chip.

## 4. What kind of configuration data is stored on the DIMM Serial Presence Detect (SPD) memory module? How would this data be written?

The DIMM SPD memory contains information about the memory module, such as size, serial number, data width, speed and timing, voltage, and thermal information. This information is written by the module manufacturer and stored on an EEPROM. You cannot write to this EEPROM when the memory module is installed in a computer. Third-party tools do exist that can write to the EEPROM when the memory module is not installed in a computer. Various third-party tools are available to read SPD memory.

## 5. What is meant by “Restore the nonvolatile memory found in Intel-based system boards”?

This message relates to clearing the Real Time Clock (RTC) CMOS memory that contains computer configuration data.

## 6. How can the BIOS security be reset to factory defaults and erase the data?

---

 **IMPORTANT:** Resetting results in the loss of information.

These steps do not reset Custom Secure Boot Keys. See question and answer 7 for information about resetting the keys.

---

- a. Turn on or restart the computer, and then quickly press `esc`.
- b. Select **Main**, and then select **Reset Security to Factory Defaults**.
- c. Follow the on-screen instructions.
- d. Select **Main**, select **Save Changes and Exit**, and then follow the on-screen instructions.

#### 7. How can the Custom Secure Boot Keys be reset?

Secure Boot is a feature to ensure that only authenticated code can start on a platform. If you enabled Secure Boot and created Custom Secure Boot Keys, disabling Secure Boot does not clear the keys. You must also select to clear the Custom Secure Boot Keys. Use the same Secure Boot access procedure that you used to create the Custom Secure Boot Keys, but select to clear or delete all Secure Boot Keys.

- a. Turn on or restart the computer, and then quickly press `esc`.
- b. Select the **Security** menu, select **Secure Boot Configuration**, and then follow the on-screen instructions.
- c. At the **Secure Boot Configuration** window, select **Secure Boot**, select **Clear Secure Boot Keys**, and then follow the on-screen instructions to continue.

## Using HP Sure Start (select products only)

Select computer models are configured with HP Sure Start, a technology that continuously monitors your computer's BIOS for attacks or corruption.

If the BIOS becomes corrupted or is attacked, HP Sure Start restores the BIOS to its previously safe state, without user intervention. Those select computer models ship with HP Sure Start configured and enabled. HP Sure Start is configured and already enabled so that most users can use the HP Sure Start default configuration. Advanced users can customize the default configuration.

To access the latest documentation on HP Sure Start, go to <http://www.hp.com/support>.

# 13 Power cord set requirements

This chapter provides power cord requirements for countries and regions.

The wide-range input feature of the computer permits it to operate from any line voltage from 100 V ac to 120 V ac, or from 220 V ac to 240 V ac.

The three-conductor power cord set included with the computer meets the requirements for use in the country or region where the equipment is purchased.

Power cord sets for use in other countries or regions must meet the requirements of the country and region where the computer is used.

## Requirements for all countries

These power cord requirements are applicable to all countries and regions.

- The length of the power cord set must be at least **1.0 m** (3.3 ft) and no more than **2.0 m** (6.5 ft).
- All power cord sets must be approved by an acceptable accredited agency responsible for evaluation in the country or region where the power cord set will be used.
- The power cord sets must have a minimum current capacity of 10 A and a nominal voltage rating of 125 V ac or 250 V ac, as required by the power system of each country or region.
- The appliance coupler must meet the mechanical configuration of an EN 60 320/IEC 320 Standard Sheet C13 connector for mating with the appliance inlet on the back of the computer.

## Requirements for specific countries and regions

To determine power cord requirements for specific countries and regions, use this table.

**Table 13-1 Power cord requirements for specific countries and regions**

Country/region	Accredited agency	Applicable note number
Argentina	IRAM	1
Australia	SAA	1
Austria	OVE	1
Belgium	CEBEC	1
Brazil	ABNT	1
Canada	CSA	2
Chile	IMQ	1
Denmark	DEMKO	1
Finland	FIMKO	1
France	UTE	1
Germany	VDE	1

**Table 13-1 Power cord requirements for specific countries and regions (continued)**

Country/region	Accredited agency	Applicable note number
India	BIS	1
Israel	SII	1
Italy	IMQ	1
Japan	JIS	3
Netherlands	KEMA	1
New Zealand	SANZ	1
Norway	NEMKO	1
People's Republic of China	CCC	4
Saudi Arabia	SASO	7
Singapore	PSB	1
South Africa	SABS	1
South Korea	KTL	5
Sweden	SEMKO	1
Switzerland	SEV	1
Taiwan	BSMI	6
Thailand	TISI	1
United Kingdom	ASTA	1
United States	UL	2

1. The flexible cord must be Type H05VV-F, three-conductor, 0.75 mm<sup>2</sup> conductor size. Power cord set fittings (appliance coupler and wall plug) must bear the certification mark of the agency responsible for evaluation in the country or region where it will be used.
2. The flexible cord must be Type SVT/SJT or equivalent, No. 18 AWG, three-conductor. The wall plug must be a two-pole grounding type with a NEMA 5-15P (15 A, 125 V ac) or NEMA 6-15P (15 A, 250 V ac) configuration. CSA or C-UL mark. UL file number must be on each element.
3. The appliance coupler, flexible cord, and wall plug must bear a T mark and registration number in accordance with the Japanese Dentori Law. The flexible cord must be Type VCTF, three-conductor, 0.75 mm<sup>2</sup> or 1.25 mm<sup>2</sup> conductor size. The wall plug must be a two-pole grounding type with a Japanese Industrial Standard C8303 (7 A, 125 V ac) configuration.
4. The flexible cord must be Type RVV, three-conductor, 0.75 mm<sup>2</sup> conductor size. Power cord set fittings (appliance coupler and wall plug) must bear the CCC certification mark.
5. The flexible cord must be Type H05VV-F three-conductor, 0.75 mm<sup>2</sup> conductor size. KTL logo and individual approval number must be on each element. Approval number and logo must be printed on a flag label.
6. The flexible cord must be Type HVCTF three-conductor, 1.25 mm<sup>2</sup> conductor size. Power cord set fittings (appliance coupler, cable, and wall plug) must bear the BSMI certification mark.
7. For 127 V ac, the flexible cord must be Type SVT or SJT 3-conductor, 18 AWG, with plug NEMA 5-15P (15 A, 125 V ac), with UL and CSA or C-UL marks. For 240 V ac, the flexible cord must be Type H05VV-F three-conductor, 0.75 mm<sup>2</sup> or 1.00 mm<sup>2</sup> conductor size, with plug BS 1363/A with BSI or ASTA marks.

---

## 14 Recycling

When a nonrechargeable or rechargeable battery has reached the end of its useful life, do not dispose of the battery in general household waste. Follow the local laws and regulations in your area for battery disposal.

HP encourages customers to recycle used electronic hardware, HP original print cartridges, and rechargeable batteries. For more information about recycling programs, see the HP website at <http://www.hp.com/recycle>.

---

# Index

- A**
  - AC adapters, spare part numbers 24
- B**
  - backup, creating 149
  - backups 149
  - BIOS
    - determining version 146
    - downloading an update 146, 147
    - updating 146
  - Bluetooth label 15
  - boot order
    - changing using the f9 prompt 147
  - boot order, changing 150
  - bottom 15
  - bottom components 14
  - bottom cover
    - removal 33
    - spare part number 33
  - Bracket Kit
    - spare part number 23
- C**
  - Cable Kit
    - spare part number 22
  - card reader board
    - removal 47
    - spare part number 47
  - cases, spare part numbers 24
  - cautions
    - electrostatic discharge 28, 29
  - component
    - bottom 14
  - components
    - display 8
    - keyboard area 9
    - left side 7
    - right side 6
  - computer major components 18
  - Computer Setup
    - navigating and selecting 145
    - restoring factory settings 145
    - starting 145
  - computer specifications 158
- D**
  - display
    - specifications 158, 159
  - display assembly
    - subcomponents 21
  - display back cover
    - illustrated 21
    - spare part number 21
  - display bezel
    - illustrated 21
    - spare part number 21
  - display cable
    - illustrated 21
    - spare part number 21
  - display components 8
  - display panel
    - illustrated 21
    - spare part number 21
  - docks, spare part numbers 24
- E**
  - electrostatic discharge (ESD) 28, 29
    - preventing damage 28, 29, 30
- F**
  - fan
    - removal 53
    - spare part number 53
  - fingerprint reader board
    - removal 50
    - spare part numbers 50
  - fingerprint reader bracket
    - illustrated 23
  - fingerprint reader insert
    - illustrated 24
- G**
  - grounding methods 28, 29, 30
  - guidelines
    - packaging 28, 32
    - transporting 28, 32
    - workstation 28
- H**
  - hard drive
    - specifications 158
  - heat sink
    - removal 54
    - spare part numbers 54
  - hinge
    - illustrated 21
    - spare part number 21
  - hinge cover
    - illustrated 21
    - spare part number 21
  - HP PC Hardware Diagnostics UEFI
    - downloading 155
    - failure ID code 154
    - starting 155
    - using 154
  - HP PC Hardware Diagnostics Windows
    - accessing 152, 153
    - downloading 153
    - failure ID code 152
    - installing 154
    - using 152
  - HP Recovery media
    - recovery 150
  - HP Sure Recover 151
  - HP Sure Start 161, 166
  - hubs, spare part numbers 24
- I**
  - I/O bracket insert
    - illustrated 24
  - illustrated parts catalog 18
- K**
  - keyboard
    - product description 3
  - keyboard with top cover
    - spare part numbers 76
- L**
  - labels
    - Bluetooth 15
    - regulatory 15
    - serial number 15



- service 15
- wireless certification 15
- WLAN 15

left side components 7

locks, spare part numbers 24

## M

memory

- nonvolatile 161
- volatile 161

memory cover

- illustrated 23

memory modules

- removal 34
- spare part numbers 34

mice, spare part numbers 24

## N

nano SIM card, inserting 16

nano SIM card, removing 17

NFC module

- removal 53
- spare part number 53

nonvolatile memory 161

## P

packaging guidelines 28, 32

Plastics Kit

- spare part number 24

pointing device, product

- description 3

ports

- product description 3

power connector cable

- removal 48
- spare part number 48

power cord

- requirements for all countries 167
- requirements for specific countries and regions 167
- set requirements 167

power cords, spare part numbers 24

product description

- keyboard 3
- pointing device 3
- ports 3
- sensors 3

product name and number, computer 15

## R

recovery 149

- discs 150
- media 150
- USB flash drive 150

recovery media 149

- creating using HP Cloud Recovery Download Tool 149
- creating using Windows tools 149

regulatory information

- regulatory label 15
- wireless certification labels 15

Remote HP PC Hardware Diagnostics

- UEFI settings

  - customizing 156
  - using 156

removal and replacement

- procedures 33, 43
- solid-state drive 40

removing personal data from volatile system memory 161

restoring 149

restoring and recovery methods 150

right side components 6

## S

Screw Kit, spare part number 24

sensors

- product description 3

serial number, computer 15

service labels, locating 15

setup utility

- navigating and selecting 145
- restoring factory settings 145

SIM card insert

- illustrated 24

SIM card, inserting 16

smart card insert

- illustrated 24

solid-state drive

- removal and replacement 40
- specifications 159

solid-state drive cover

- illustrated 23

spare part country codes 76

speaker

- removal 46
- spare part numbers 46

special keys, using 13

specifications

- computer 158
- display 158, 159
- hard drive 158
- solid-state drive 159

static electricity 28, 29

Sure Start

- using 148

system board

- removal 57
- spare part numbers 57

system memory, removing personal data from volatile 161

system restore 150

system restore point, creating 149

## T

touchpad

- removal 51
- settings 9
- spare part number 51

TPM settings 147

transporting guidelines 28, 32

traveling with the computer 15

## U

USB board

- removal 49
- spare part number 49

USB bracket

- illustrated 23

## W

Windows

- backup 149
- recovery media 149
- system restore point 149

Windows tools, using 149

wireless antennas

- illustrated 21
- spare part number 21

wireless certification label 15

WLAN device 15

WLAN label 15

WLAN module

- removal 37
- spare part numbers 37

workstation guidelines 28

WWAN insulator

- illustrated 24

WWAN module  
removal 38  
spare part numbers 38