

# **USER MANUAL**

# ***ProLite***

## **LCD Monitor**

ENGLISH

### ***ProLite T2455MSC***

Thank you very much for choosing the iiyama LCD monitor.

We recommend that you take a few minutes to read carefully through this brief but comprehensive manual before installing and switching on the monitor. Please keep this manual in a safe place for your future reference.



**Dear user, we congratulate you on the purchase of your iiyama LCD.**

For details on warranty and locally used pixel policies that apply directly after installation of your product please check the iiyama website.

**To report a fault, please contact your local support centre found at <https://iiyama.com>**

**Things to check before you call the iiyama information line**

- | if the power cable is connected securely and turned on?
- | if the display has been turned on?
- | if the signal cable is connected securely and the correct input selected?
- | if the computer has been restarted with the display connected?
- | if the graphics card is correctly installed with the latest drivers possible?
- | if the correct native resolution has been selected via 'Display Properties'?
- | If the R/G/B signal configuration is correct?
- | if the displays On Screen Menu is shown?
- | if the correct brightness and contrast settings have been set?
- | if given display tolerances and compatibility have been considered?
- | if via the On Screen Menu you have performed a Factory Reset/Recall?

**Before reporting the screen defect, please prepare the following information/evidence:**

- | model number \*
- | purchase receipt and serial number \*
- | name and address for collection
- | telephone/fax number, for availability during the day
- | convenient collection date (date, time)
- | short description of the defect

**Important Note:**

If there is no fault found in the collected equipment after inspection, the transferring party shall incur charges for transport and administration.

If you have checked all of the above and there is still no picture, call our information line for assistance in your country.

\* see the identification plate on the back of the case.

## CE MARKING DECLARATION OF CONFORMITY

This LCD monitor complies with the requirements of the EC/EU Directive 2014/30/EU "EMC Directive", 2014/35/EU "Low Voltage Directive", 2009/125/EC "ErP Directive" and 2011/65/EU "RoHS Directive".

The electro-magnetic susceptibility has been chosen at a level that gives correct operation in residential areas, business and light industrial premises and small-scale enterprises, inside as well as outside of the buildings. All places of operation are characterised by their connection to the public low voltage power supply system.

IYAMA CORPORATION: Wijkmeerstraat 8, 2131 HA Hoofddorp, The Netherlands

Model No. : PL2455M



We recommend recycling of used product. Please contact your dealer or iiyama service center. Recycle information is obtained via the Internet, using the address: <https://iiyama.com>

You can access the Web page of different countries from there.

- We reserve the right to change specifications without notice.
- All trademarks used in this user manual are the property of their respective owners.
- As an ENERGY STAR® Partner, iiyama has determined that this product meets the ENERGY STAR® guidelines for energy efficiency.
- This product qualifies for ENERGY STAR® in the "factory default" setting and this is the setting in which power saving will be achieved. Changing the factory default picture settings or enabling other features will increase power consumption that could exceed the limits necessary to qualify for ENERGY STAR® rating.
- Eprel registration number T2455MSC-B1 : 1326410

# TABLE OF CONTENTS

FOR YOUR SAFETY.....	1
SAFETY PRECAUTIONS.....	1
SPECIAL NOTES ON LCD MONITORS.....	3
CUSTOMER SERVICE.....	3
CLEANING.....	3
BEFORE YOU OPERATE THE MONITOR.....	4
FEATURES.....	4
CHECKING THE CONTENTS OF THE PACKAGE.....	4
INSTALLATION.....	5
CONTROLS AND CONNECTORS.....	6
CONNECTING YOUR MONITOR.....	7
COMPUTER SETTING.....	8
ADJUSTING THE VIEWING ANGLE.....	10
OPERATING THE MONITOR.....	11
ADJUSTMENT MENU CONTENTS.....	12
STANDBY FEATURE.....	19
TROUBLE SHOOTING.....	20
RECYCLING INFORMATION.....	21
APPENDIX.....	22
SPECIFICATIONS : ProLite T2455MSC-B1.....	22
DIMENSIONS.....	23
COMPLIANT TIMING.....	23

# FOR YOUR SAFETY

## SAFETY PRECAUTIONS

### WARNING

#### **STOP OPERATING THE MONITOR IF YOU ARE AWARE OF ANY PROBLEMS**

If you notice any abnormal phenomena such as smoke, strange sounds or fumes, unplug the monitor and contact your dealer or iiyama service center immediately. Further use may be dangerous and can cause fire or electric shock.

#### **NEVER REMOVE THE CABINET**

High voltage circuits are inside the monitor. Removing the cabinet may expose you to the danger of fire or electric shock.

#### **DO NOT PUT ANY OBJECT INTO THE MONITOR**

Do not put any solid objects or liquids such as water into the monitor. In case of an accident, unplug your monitor immediately and contact your dealer or iiyama service center. Using the monitor with any object inside may cause fire, electric shock or damage.

#### **INSTALL THE MONITOR ON A FLAT, STABLE SURFACE**

The monitor may cause an injury if it falls or is dropped.

#### **DO NOT USE THE MONITOR NEAR WATER**

Do not use where water may be splashed or spilt onto the monitor as it may cause fire or electric shock.

#### **OPERATE UNDER THE SPECIFIED POWER SUPPLY**

Be sure to operate the monitor only with the specified power supply. Use of an incorrect voltage will cause malfunction and may cause fire or electric shock.

#### **PROTECT THE CABLES**

Do not pull or bend the power cable and signal cable. Do not place the monitor or any other heavy objects on the cables. If damaged, the cables may cause fire or electric shock.

#### **ADVERSE WEATHER CONDITIONS**

It is advisable not to operate the monitor during a heavy thunder storm as the continual breaks in power may cause malfunction. It is also advised not to touch the plug in these circumstances as it may cause electric shock.

## CAUTION

### INSTALLATION LOCATION

Do not install the monitor where sudden temperature changes may occur, or in humid, dusty or smoky areas as it may cause fire, electric shock or damage. You should also avoid areas where the sun shines directly on the monitor.

### DO NOT PLACE THE MONITOR IN A HAZARDOUS POSITION

The monitor may topple and cause injury if not suitably located. Please also ensure that you do not place any heavy objects on the monitor, and that all cables are routed such that children may not pull the cables and possibly cause injury.

### MAINTAIN GOOD VENTILATION

Ventilation slots are provided to keep the monitor from overheating. Covering the slots may cause fire. To allow adequate air circulation, place the monitor at least 10cm (or 4 inches) from any walls. When removing the tilt stand, the ventilation slots on the back side of the monitor can be blocked. This may overheat the monitor and may cause fire or damage. Make sure to allow enough ventilation when removing the tilt stand. Operating the monitor on its back, side, upside down or on a carpet or any other soft material may also cause damage.

### DISCONNECT THE CABLES WHEN YOU MOVE THE MONITOR

When you move the monitor, turn off the power switch, unplug the monitor and be sure the signal cable is disconnected. If you do not disconnect them, it may cause fire or electric shock.

### UNPLUG THE MONITOR

If the monitor is not in use for a long period of time it is recommended that it is left unplugged to avoid accidents.

### HOLD THE PLUG WHEN DISCONNECTING

To disconnect the power cable or signal cable, always pull it by the plug. Never pull on the cable itself as this may cause fire or electric shock.

### DO NOT TOUCH THE PLUG WITH WET HANDS

Pulling or inserting the plug with wet hands may cause electric shock.

### WHEN YOU INSTALL THE MONITOR ON YOUR COMPUTER

Be sure the computer is strong enough to hold the weight of the monitor, otherwise, you may damage your computer.

### REMARK FOR 24/7 USAGE

This product is not specifically designed for 24/7 usage in all environments.

## OTHERS

### ERGONOMIC RECOMMENDATIONS

To eliminate eye fatigue, do not operate the monitor against a bright background or in a dark room. For optimal viewing comfort, the monitor should be just below eye level and 40-60 cm (16-24 inches) away from your eyes. When using the monitor over a prolonged time, a ten minute break every hour is recommended as looking at the screen continuously can cause eye strain.

## SPECIAL NOTES ON LCD MONITORS

The following symptoms are normal with LCD monitors and do not indicate a problem.

- NOTE**
- When you first turn on the LCD monitor, the picture may not fit in the display area because of the type of computer that is used. In this case, adjust the picture position to the correct position.
  - You may find slightly uneven brightness on the screen depending on the desktop pattern you use.
  - Due to the nature of the LCD screen, an afterimage of the previous screen may remain after switching the image, when the same image is displayed for hours. In this case, the screen can be recovered slowly by changing the image or turning off the Power Switch for some hours.

## CUSTOMER SERVICE

- NOTE**
- If you have to return your unit for service and the original packaging has been discarded, please contact your dealer or iiyama service center for advice or replacement packaging.

## CLEANING

- WARNING**
- If you drop any materials or liquids such as water into the monitor when cleaning, unplug the power cable immediately and contact your dealer or iiyama service center.

- CAUTION**
- For safety reasons, turn off the power switch and unplug the monitor before you clean it.

- NOTE**
- To protect the LCD panel, do not scratch or rub the screen with a hard object.
  - Never use any of the following strong solvents. These will damage the cabinet and the LCD screen.

Thinner	Spray-type cleaner
Benzene	Wax
Abrasive cleaner	Acid or Alkaline solvent

- Touching the cabinet with any product made from rubber or plastic for a long time may cause degeneration or loss of paint on the cabinet.

**CABINET** Stains can be removed with a cloth lightly moistened with a mild detergent solvent. Then wipe the cabinet with a soft dry cloth.

**LCD** Periodic cleaning with a soft dry cloth is recommended.

**SCREEN** Don't use tissue paper etc. because these will damage the LCD screen.

# BEFORE YOU OPERATE THE MONITOR

## FEATURES

- ◆ Supports Resolutions up to 1920 × 1080
- ◆ High Contrast 1000:1 (Typical), Adv. Contrast Function Available / Brightness 360cd/m<sup>2</sup> (Typical: with Touch panel)
- ◆ Blue Light Reducer
- ◆ Digital Character Smoothing
- ◆ Stereo Speakers  
2 × 1W Stereo Speakers
- ◆ Standby Feature
- ◆ VESA Mounting Standard (100mm×100mm) Compliant
- ◆ Keyhole for Security Lock

## CHECKING THE CONTENTS OF THE PACKAGE

The following accessories are included in your package. Check to see if they are enclosed with the monitor. If anything is missing or damaged, please contact your local iiyama dealer or regional iiyama office.

- |                |                |                     |
|----------------|----------------|---------------------|
| ■ Power Cable* | ■ HDMI Cable   | ■ USB Cable         |
| ■ Spiral tube  | ■ Safety Guide | ■ Quick Start Guide |

### CAUTION

- \* The rating of the Power Cable enclosed in 120V area is 10A/125V. If you are using a power supply higher than this rating, then a power cable with a rating of 10A/250V must be used. However, all guarantees and warranties are void for any problems or damage caused by a power cable not supplied by iiyama. An approved power cable greater or equal to H05VVF, 3G, 0.75mm<sup>2</sup> must be used.



## INSTALLATION

### CAUTION

- Before installation, make sure the wall, ceiling or desktop arm is strong enough to hold the necessary weight of the display and the mount.

### < WALL MOUNTING >

### CAUTION

- When you use with the wall mounting, in consideration of thickness of the mounting stage, tighten the M4 Screws (4pcs) which “L” length is 11mm to fasten the monitor. Using the screw longer than this may cause electric shock or damage because it may contact with the electrical parts inside the monitor.

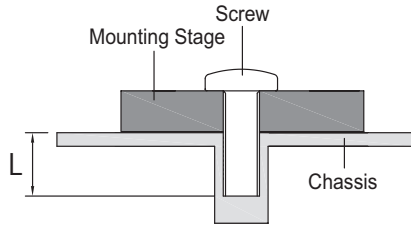

### [ROTATING THE MONITOR]

The monitor is designed to be compatible only with the landscape mode.

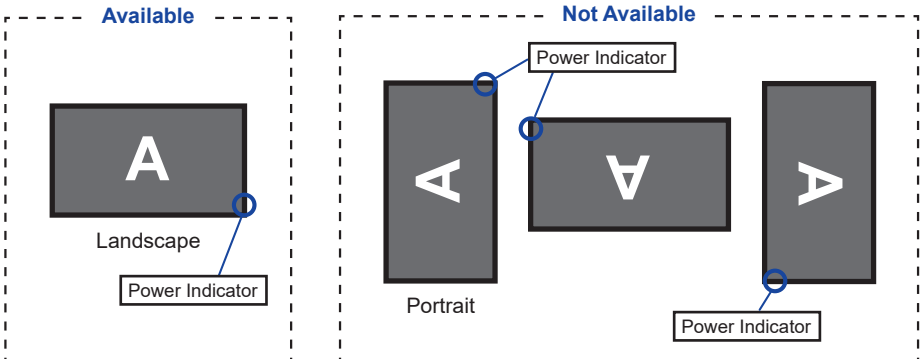

## CONTROLS AND CONNECTORS

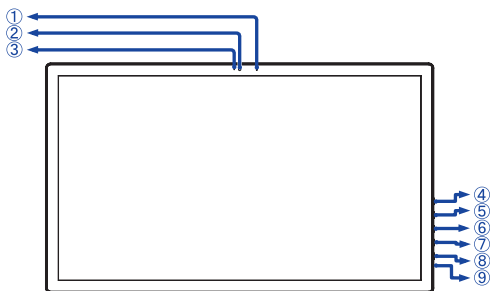

<Front>

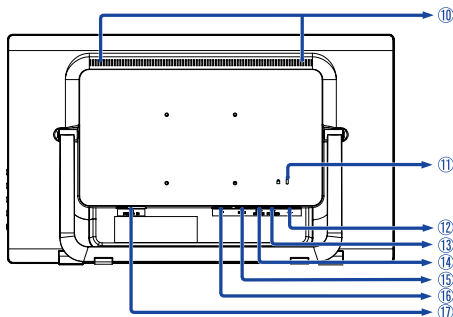

<Back>

- ① Microphone
- ② Web Camera
- ③ Web Camera Indicator
- NOTE** Light indicating webcam is on.
- ④ Menu Button ( ① )
- ⑤ Scroll up / Eco Button ( ▲ )
- ⑥ Scroll down / Volume Button ( ▼ )
- ⑦ Select / Input select Button ( ② )
- ⑧ Power Switch ( ⏻ )
- ⑨ Power Indicator
- NOTE** Blue: Normal operation  
Orange: Standby mode
- ⑩ Speakers
- ⑪ Keyhole for Security Lock
- NOTE** You can fasten a security lock and cable to prevent the monitor from being removed without your permission.
- ⑫ USB Downstream Connector ( ⚡ 5V, 900mA)
- ⑬ USB Upstream Connector ( ⚡ PC USB)
- ⑭ Headphone Connector (EARPHONE)
- ⑮ HDMI Connector (HDMI)
- ⑯ DisplayPort Connector (DP)
- ⑰ AC Connector( ~ : Alternating current) (AC POWER IN)

## CONNECTING YOUR MONITOR

- ① Ensure that both the computer and the monitor are switched off.
- ② Connect the computer to the monitor with the signal cable.
- ③ Connect the computer to the monitor with the USB Cable.
- ④ Connect the Power Cable to the monitor first and then to the power source.
- ⑤ Turn on your monitor and computer.

### NOTE

- Make sure that the building installation has a circuit breaker of 120/240V, 20A (maximum).
- The signal cables used for connecting the computer and monitor may vary with the type of computer used. An incorrect connection may cause serious damage to both the monitor and the computer. The cable supplied with the monitor is for a standard connector. If a special cable is required please contact your local iiyama dealer or regional iiyama office.
- Make sure you tighten the finger screws at each end of the signal cable.
- The Class I pluggable equipment Type A must be connected to protective earth.
- The socket-outlet shall be installed near the equipment and shall be easily accessible.
- Excessive sound pressure from ear-/headphones can cause hearing damage/hearing loss.

[Example of Connection]

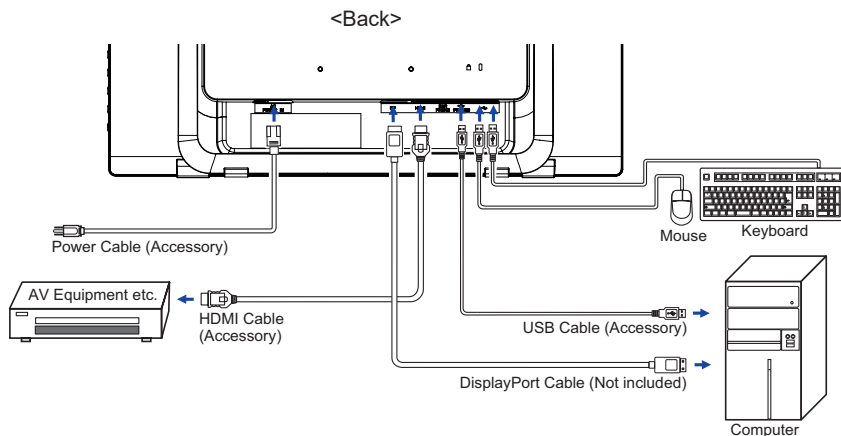

## COMPUTER SETTING

### ■ Signal Timing

Change to the desired signal timing listed on page 23: COMPLIANT TIMING.

### ■ TOUCH support operation system

	Mouse	Digitizer	Gestures*
Windows8/8.1/10/11	×	○	○
Windows7	×	○	○
Windows Vista	×	○	×
Windows XP	○	×	×
Mac OS/OS X	×	×	×
Linux	△	×	×
Android	×	×	×
Functions	Click Drag Double-Click	Flick Visual feedback	Digitizer functions Press & Tap, Rotate, Zoom-in/out

The other OS Versions not listed are not supported.

○ : Supported   × : Not supported   △ : Depend on which Linux support from OS version

\* Gestures can be supported by application programs.

## ■ Touch Input Settings in Dual Screen Mode

① Connect the primary monitor to the computer first.

Set Control Panel > Hardware and Sound > Tablet PC Settings > Display > Setup.

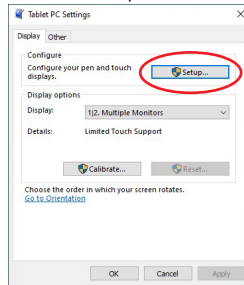
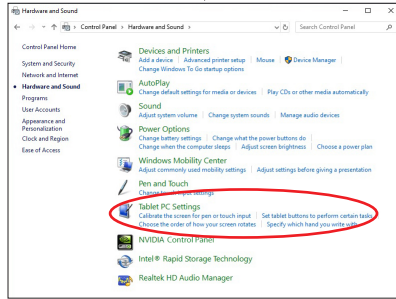
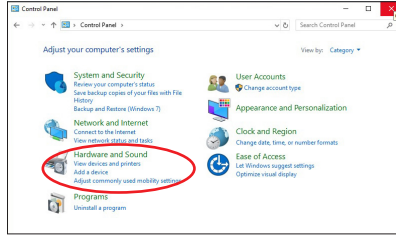

The following message will appear on the screen. Please follow the instructions.

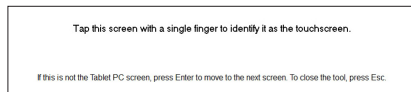

② After setting ①, connect a second monitor and perform the setup as in ①.

**NOTE** The monitors are recognized as dual-display, and touch operation cannot be performed on two monitors at the same time.

You can perform touch operation on only one of the monitors.

## ADJUSTING THE VIEWING ANGLE

- For optimal viewing it is recommended to look at the full face of the monitor.
  - You are able to adjust the monitor's angle up to 15 - 65 degrees upward.
- ① Put a piece of soft cloth on the table beforehand to prevent the monitor from being scratched. Lay the monitor flat on a table with front face down.
  - ② Hold the monitor and pull the stand up until you hear a click.
  - ③ Stand the monitor in the upright position. Adjust the screen tilt to your preference.

### NOTE

- Do not touch the LCD screen when you change the angle. It may cause damage or break the LCD screen.
- Careful attention is required not to pinch your fingers or hands into the moving part of the stand when you change the angle.
- When packaged, the stand is folded. Do not use in this state otherwise injury may occur if it falls or is dropped.

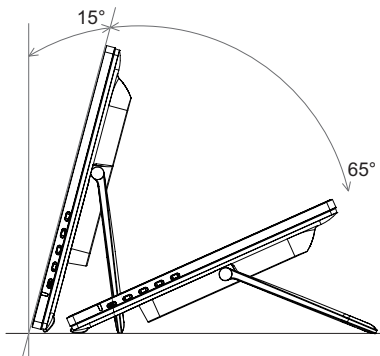

# OPERATING THE MONITOR

To create the best picture, your iiyama LCD monitor has been preset at the factory with the COMPLIANT TIMING shown on page 23. You are also able to adjust the picture by following the button operation shown below.

- 1 Press the ① Button to start the On Screen Display (OSD) feature. There are additional Menu items which can be switched by using the ▲ / ▼ Buttons.



- 2 Select the Menu item which contains the adjustment icon relating to the adjustment you want to make. Press the ② Button. Then, use the ▲ / ▼ Buttons to highlight the desired adjustment icon.
- 3 Press the ② Button again. Use the ▲ / ▼ Buttons to make the appropriate adjustment or setting.
- 4 Press the ① Button to leave the menu, and the settings you just made would be automatically saved.

For example, to correct for OSD vertical position, select Menu item of OSD and then press the ② Button. Then, select OSD Vertical Position by using the ▲ / ▼ Buttons.

An adjustment page appears after you press the ② Button. Then, use the ▲ / ▼ Buttons to change the OSD vertical position settings.

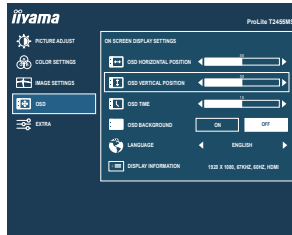

Press the ① Button lastly, it ends, all changes are saved in the memory.

## NOTE

- When button operations are aborted during adjustment, On-Screen Display disappears when the time set for the OSD Time has passed. Also, the ① button can be used to return previous menu and turn off the On-Screen Display.
- Any changes are automatically saved in the memory when the On Screen Display disappears. Turning off the power should be avoided while using the Menu.
- All adjustments have only one setting which applies to all signal timings.

## ADJUSTMENT MENU CONTENTS



### Picture Adjust

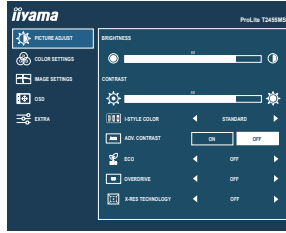

Adjustment Item	Problem / Option		Button to Press
Brightness *1,2	Too dark		← ▲
	Too bright		→ ▼
Contrast *1	Too dull		← ▲
	Too intense		→ ▼
i-Style Color *1,2,3	Off	Return to a state set by color adjustment except i-Style Color.	
	Standard	For general windows environment and monitor default setting.	
	Game	For PC game environment.	
	Cinema	For movie and video environment.	
	Scenery	For displaying outdoor scenery images	
	Text	For text editing and viewing in a word processing environment.	
Adv. Contrast *1	On	Increased Contrast Ratio	
	Off	Typical Contrast Ratio	
<p><b>NOTE</b> Adv. Contrast adjusts brightness according to the image, and improve the contrast ratio during movie playing.            Contrast, Brightness, i-Style Color, Eco, Gamma and Color Temp. cannot be adjusted and selected while Adv. Contrast is active.</p>			
Eco *1	<b>Direct</b>	Off	Normal
		Mode1	Brightness of back-light is reduced.
		Mode2	Brightness of back-light is reduced more than Mode 1.
		Mode3	Brightness of back-light is reduced more than Mode2.

### Direct

You can skip the Menu items and directly display an option setting screen by using the following button operations.



- Eco: Press the ▲ Button when the Menu is not displayed.



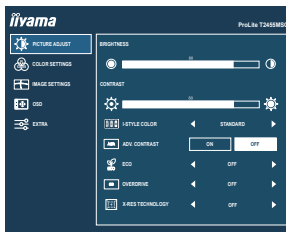

## Picture Adjust



Adjustment Item	Problem / Option	Button to Press
Overdrive *4	Off / 1 / 2 / 3 / 4 / 5 It will improve the gray level response time of the LCD panel. A higher level results in a faster response time.	  
X-Res Technology	Off	Normal
	Soft	Enhance the picture edge.
	Middle	Enhance the picture edge more than the Soft option.
	Hard	Enhance the picture edge more than the Middle option.

\*1 The availability of each item depends on which item is activated. See page 18 Function Correlation Matrix for more details.

\*2 Adjust the Brightness when you are using the monitor in a dark room and feel the screen is too bright.

\*3 i-Style Color is disabled when Blue Light Reducer is activated.

\*4 When Overdrive is activated, some level of image retention will be caused.



## Color Settings \*1

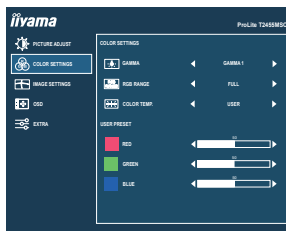

Adjustment Item	Problem / Option		Button to Press	
Gamma *2	Gamma 1	High contrast		
	Gamma 2	Normal		
	Gamma 3	Dark		
RGB Range	Full	For full-range color scale signalscale signal		
	Limited	For limited color scale signal		
Color Temp. *2	User	Red	Too weak Too strong	
		Green		
		Blue		
	Cool	Cool color		
	Normal	Normal color		
Warm	Warm color			



\*1 Color Settings are disabled when Blue Light Reducer is activated.

\*2 The availability of each item depends on which item is activated. See page 18 Function Correlation Matrix for more details.

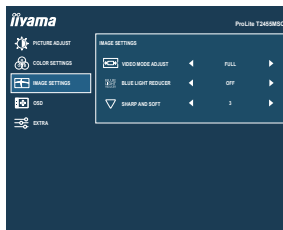

## Image Settings



Adjustment Item	Problem / Option		Button to Press
Video Mode Adjust *1	Full	Expansion display	
	Aspect	Expansion display of Aspect	
Blue Light Reducer *2	Off	Typical	
	Mode 1	Blue light is reduced.	
	Mode 2	Blue light is reduced more than Mode 1.	
	Mode 3	Blue light is reduced more than Mode 2.	
Sharp and Soft *1	1 / 2 / 3 / 4 / 5 / 6		  
<p>You can change the picture quality from 1 to 6 (sharp to soft). Press the ▲ Button to change the picture quality in numerical order. Press the ▼ Button to change the picture quality in reverse numerical order.</p>			









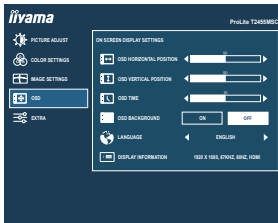

\*1 It can display in the center of the screen with a 4:3, 5:4 or 16:10 aspect ratio when input video resolution is 4:3, 5:4 or 16:10.

When display scaling is preserved or selected scaling mode or scaling option on GPU, it will be enabled for this function.

\*2 Blue Light Reducer cannot be enabled if i-Style Color, Adv.Contrast or Eco is enabled.

 **OSD**



Adjustment Item	Problem / Option		Button to Press	
OSD Horizontal Position	OSD is too left OSD is too right		   	
OSD Vertical Position	OSD is too low OSD is too high		   	
OSD Time	You can set the OSD display duration time between 5 and 60 seconds.		  	
OSD Background	On	The background of OSD is made transparent.		
	Off	Return the background of OSD.		
Language	English	English	Česky	Czech
	Français	French	Italiano	Italian
	Deutsch	German	Русский	Russian
	Nederlands	Dutch	日本語	Japanese
	Polski	Polish		
Display Information	Displays information regarding the current input signal coming from the graphic card in your computer. <b>NOTE</b> See your graphic card user guide for more information about changing the resolution and refresh.			



Extra

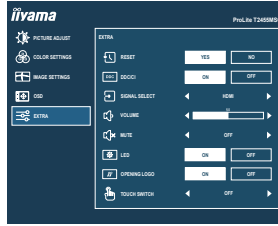

ENGLISH

Adjustment Item	Problem / Option		Button to Press
Reset	Yes	Factory-preset data is restored.	
	No	Return to Menu.	
DDC/CI	On	DDC/CI is On.	
	Off	DDC/CI is Off.	
Signal Select <b>Direct</b>	Auto	Select the signal input automatically.	
	HDMI	Select the Digital (HDMI) input.	
	DisplayPort	Select the Digital (DisplayPort) input.	
<b>NOTE</b> If "Auto" is selected, only one source available is selected automatically. Input source is fixed, not selected automatically when HDMI and DisplayPort are selected.			
Volume <b>Direct</b>	Too soft		
	Too loud		
Mute <b>Direct</b>	On	Turn off the sound temporarily.	
	Off	Return the sound volume to the previous level.	
LED	On	The Power Indicator is turned On.	
	Off	The Power Indicator is turned Off.	
<b>NOTE</b> Turn Off the Power Indicator when you are bothered by the light.			
Opening Logo	On	Opening Logo is On.	
	Off	Opening Logo is Off.	
Touch Switch *	Off	Normal touch (with bare hands or stylus device)	
	Glove	Touch with gloved hand (Supports thickness +2mm)	

\* Please turn on the power and set the Touch Switch after the monitor installation is completed. Turning on the power and setting the Touch Switch before the monitor installation may cause misalignment or malfunction of the touch calibration.

## Direct

You can skip the Menu items and directly display an option setting screen or an adjustment scale by using the following button operations.

- Volume: Press the ▼ Button when the Menu is not displayed.
- Mute: Pressing and holding of the ▼ Button for about 2 seconds when the Menu is not displayed. Mute and Unmute are switched as follows by pressing the ▼ Button successively.
- Signal Select: Press the ② Button when the Menu is not displayed, it shows following Menu.



- Lock Mode:

### <OSD>

Pressing and holding the ① button for 5 seconds when Menu is not displayed, it will lock/unlock the OSD Lock function.

### <Power>

Pressing and holding the ② button for 5 seconds when Menu is not displayed, will lock/unlock the Power Lock function.

## ■ Function Correlation Matrix

Item to be selected Item activated	Picture Adjust					Color Settings	
	Contrast	Brightness	i-Style Color	Adv. Contrast	Eco	Gamma	Color Temp.
i-Style Color	—	—	—	—	—	—	✓
Adv. Contrast	—	—	—	—	—	—	—
Eco	✓	—	✓	✓	—	✓	✓

✓ : Available

— : Not available

## STANDBY FEATURE

This product features the standby function. When activated, it automatically reduces unnecessary power consumption of the monitor when your computer is not in use.

There is a standby step the monitor takes as described below. The standby function, including any timer settings is configured by the operating system. Check your operating system manual for information on how this can be configured.

### ■ Standby Mode

When the video signal from the computer is off, the monitor enters into Standby Mode which reduces the power consumption to less than 1.5W\*. The screen becomes dark, and the power indicator turns to orange. From Standby Mode, the image reappears in several seconds when either the keyboard or the mouse are touched again.

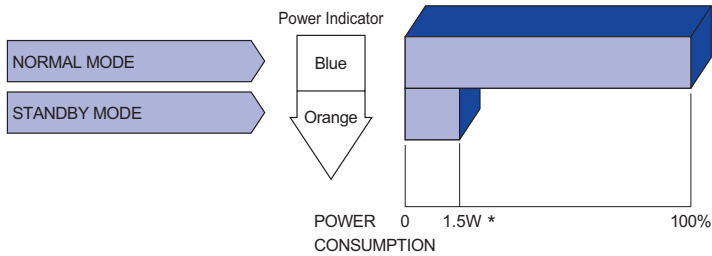

\* When the USB devices are not connected.

# TROUBLE SHOOTING

If the monitor fails to operate correctly, please follow the steps below for a possible solution.

1. Perform the adjustments described in OPERATING THE MONITOR, depending on the problem you have. If the monitor does not get a picture, skip to 2.
2. Consult the following items if you cannot find an appropriate adjustment item in OPERATING THE MONITOR or if the problem persists.
3. If you are experiencing a problem which is not described below or you cannot correct the problem, discontinue using the monitor and contact your dealer or iiyama service center for further assistance.

## Problem

## Check

- ① The picture does not appear.

(Power indicator does not light up.)

- The Power Cable is firmly seated in the socket.
- The Power Switch is turned ON.
- The AC socket is live. Please check with another piece of equipment.

(Power indicator is blue.)

- If the blank screen saver is in active mode, touch the keyboard or the mouse.
- Increase the Contrast and/or Brightness.
- The computer is ON.
- The Signal Cable is properly connected.
- The signal timing of the computer is within the specification of the monitor.

(Power indicator is orange.)

- If the monitor is in standby mode, touch the keyboard or the mouse.
- The computer is ON.
- The Signal Cable is properly connected.
- The signal timing of the computer is within the specification of the monitor.

- ② The screen is not synchronized.

- The Signal Cable is properly connected.
- The signal timing of the computer is within the specification of the monitor.

- ③ The screen position is not in the center.

- The signal timing of the computer is within the specification of the monitor.

- ④ The screen is too bright or too dark.

- The video output level of the computer is within the specification of the monitor.

- ⑤ The screen is shaking.

- The power voltage is within the specification of the monitor.
- The signal timing of the computer is within the specification of the monitor.

- ⑥ No sound.

- The audio equipment (computer etc.) is ON.
- The Audio Cable is properly connected.
- The Volume is turned up.
- The Mute is OFF.
- The audio output level of the audio equipment is within the specification of the monitor.



## Problem

## Check

- |  |   |
|--|---|
| ⑦ The sound is too loud or too quiet.  | <input type="checkbox"/> The audio output level of the audio equipment is within the specification of the monitor.                            |
| ⑧ A strange noise is heard.            | <input type="checkbox"/> The Audio Cable is properly connected.   |
| ⑨ The touch screen shows no response.  | <input type="checkbox"/> The USB Cable is firmly seated in the socket.<br><input type="checkbox"/> Touch screen driver software is installed. |
| ⑩ The touch position does not deviate. | <input type="checkbox"/> The calibration function set up correctly.   |

## RECYCLING INFORMATION

For better environment protection please don't dispose your monitor.  
Please visit our web site: <https://iiyama.com> for monitor recycling.

# APPENDIX

Design and specifications are subject to change without prior notice.

## SPECIFICATIONS : ProLite T2455MSC-B1

Touch Screen	Technology	Projected capacitive 10pt touch
	Light transmission	90%
	Communication system	USB
Size Category		24"
LCD Panel	Panel technology	IPS
	Size	Diagonal: 23.8" (60.47cm)
	Pixel pitch	0.2745mm H × 0.2745mm V
	Brightness	400cd/m <sup>2</sup> (Typical: without Touch panel), 360cd/m <sup>2</sup> (Typical: with Touch panel), 305cd/m <sup>2</sup> (Default / Energy Saving)
	Contrast ratio	1000 : 1 (Typical: with Touch panel), Adv. Contrast Function Available
	Viewable angle	Right / Left : 89 degrees each, Up / Down: 89 degrees each (Typical)
	Response time	14ms (Typical), 5ms (Gray to Gray) <sup>*3</sup>
Display Colors		Approx. 16.7M
Sync Frequency		Horizontal: 30.0-83.0kHz, Vertical: 55-76Hz
Native Resolution		1920 × 1080, 2.1 MegaPixels
Supported max. resolution		1920 × 1080 60Hz
Input Connector		HDMI, DisplayPort
Input Video Signal		HDMI, DisplayPort
USB Standard		USB3.0 (DC5V, 900mA)
Number of USB Ports		1 Upstream : Series B
Connector shape		2 Downstream : Series A
Headphone Connector		ø 3.5mm mini jack (Stereo)
Speakers		1W × 2 (Stereo speakers)
Web Camera		0.9 MegaPixels
Maximum Screen Size		527.04mm W × 296.46mm H / 20.7" W × 11.7" H
Power Source		100-240VAC, 50/60Hz, 0.8A
Power Consumption <sup>*1</sup>		18W typical, Standby mode: 1.5W maximum, Off mode: 0.3W maximum
Dimensions <sup>*2</sup> / Net Weight		567.0 × 337.5 × 43.5mm / 22.3 × 13.3 × 1.7" (W×H×D) 4.4kg / 9.7lbs
Tilt Angle		Upward: 15 - 65 degrees
Environmental Considerations		Operating: Temperature 5 to 35°C / 41 to 95°F Humidity 10 to 90% (No condensation) Storage: Temperature -20 to 60°C / -4 to 140°F Humidity 10 to 90% (No condensation)
Approvals		CE, UKCA, TÜV-Bauart, VCCI, PSE, EAC

**NOTE** <sup>\*1</sup> When the USB devices are not connected.

<sup>\*2</sup> When the stand is closed.

<sup>\*3</sup> When set to Overdrive +5.

## DIMENSIONS

\* When the stand is closed.

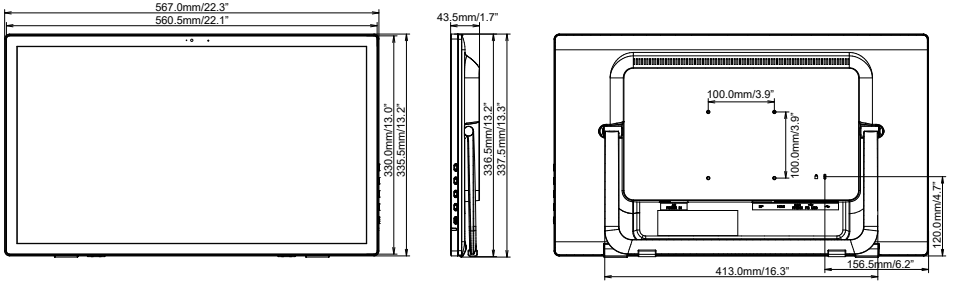

ENGLISH

## COMPLIANT TIMING

Video Mode	Horizontal Frequency	Vertical Frequency	Dot Clock
640 × 480	31.469kHz	59.940Hz	25.175MHz
	37.500kHz	75.000Hz	31.500MHz
	37.861kHz	72.809Hz	31.500MHz
800 × 600	35.156kHz	56.250Hz	36.000MHz
	37.879kHz	60.317Hz	40.000MHz
	46.875kHz	75.000Hz	49.500MHz
1024 × 768	48.363kHz	60.004Hz	65.000MHz
	56.476kHz	70.069Hz	75.000MHz
	60.023kHz	75.029Hz	78.750MHz
1280 × 1024	63.981kHz	60.020Hz	108.000MHz
	79.976kHz	75.025Hz	135.000MHz
1440 × 900	55.935kHz	59.887Hz	106.500MHz
1680 × 1050	65.290kHz	60.000Hz	146.250MHz
1920 × 1080	66.590kHz	59.930Hz	138.500MHz