

# SUPER<sup>®</sup>

SUPER<sup>®</sup> X8ST3-F

SUPER<sup>®</sup> X8STE

## USER'S MANUAL

Revision 1.3

---

The information in this User's Manual has been carefully reviewed and is believed to be accurate. The vendor assumes no responsibility for any inaccuracies that may be contained in this document, makes no commitment to update or to keep current the information in this manual, or to notify any person or organization of the updates. **Please Note: For the most up-to-date version of this manual, please see our web site at [www.supermicro.com](http://www.supermicro.com).**

Super Micro Computer, Inc. ("Supermicro") reserves the right to make changes to the product described in this manual at any time and without notice. This product, including software and documentation, is the property of Supermicro and/or its licensors, and is supplied only under a license. Any use or reproduction of this product is not allowed, except as expressly permitted by the terms of said license.

IN NO EVENT WILL SUPER MICRO COMPUTER, INC. BE LIABLE FOR DIRECT, INDIRECT, SPECIAL, INCIDENTAL, SPECULATIVE OR CONSEQUENTIAL DAMAGES ARISING FROM THE USE OR INABILITY TO USE THIS PRODUCT OR DOCUMENTATION, EVEN IF ADVISED OF THE POSSIBILITY OF SUCH DAMAGES. IN PARTICULAR, SUPER MICRO COMPUTER, INC. SHALL NOT HAVE LIABILITY FOR ANY HARDWARE, SOFTWARE, OR DATA STORED OR USED WITH THE PRODUCT, INCLUDING THE COSTS OF REPAIRING, REPLACING, INTEGRATING, INSTALLING OR RECOVERING SUCH HARDWARE, SOFTWARE, OR DATA.

Any disputes arising between manufacturer and customer shall be governed by the laws of Santa Clara County in the State of California, USA. The State of California, County of Santa Clara shall be the exclusive venue for the resolution of any such disputes. Supermicro's total liability for all claims will not exceed the price paid for the hardware product.

---

FCC Statement: This equipment has been tested and found to comply with the limits for a Class A digital device pursuant to Part 15 of the FCC Rules. These limits are designed to provide reasonable protection against harmful interference when the equipment is operated in a commercial environment. This equipment generates, uses, and can radiate radio frequency energy and, if not installed and used in accordance with the manufacturer's instruction manual, may cause harmful interference with radio communications. Operation of this equipment in a residential area is likely to cause harmful interference, in which case you will be required to correct the interference at your own expense.

---

California Best Management Practices Regulations for Perchlorate Materials: This Perchlorate warning applies only to products containing CR (Manganese Dioxide) Lithium coin cells. "Perchlorate Material-special handling may apply. See [www.dtsc.ca.gov/hazardouswaste/perchlorate](http://www.dtsc.ca.gov/hazardouswaste/perchlorate)".

**WARNING:** Handling of lead solder materials used in this product may expose you to lead, a chemical known to the State of California to cause birth defects and other reproductive harm.

---

Manual Revision 1.3

Release Date: January 11, 2012

Unless you request and receive written permission from Super Micro Computer, Inc., you may not copy any part of this document.

Information in this document is subject to change without notice. Other products and companies referred to herein are trademarks or registered trademarks of their respective companies or mark holders.

Copyright © 2012 by Super Micro Computer, Inc.  
All rights reserved.

**Printed in the United States of America**

## Preface

This manual is written for system integrators, PC technicians and knowledgeable PC users. It provides information for the installation and use of the **SUPER** X8ST3-F/X8STE motherboard.

### About This Motherboard

The **SUPER** X8ST3-F/X8STE supports the Intel® Core™ i7 990X, i7-980X, i7-975, i7-965 Extreme Edition, Intel® Xeon® 5600/5500 series and Intel® Xeon® 3600/3500 series. These processors support the Intel QuickPath Interconnect (QPI) technology, providing the next generation point-to-point system interface that replaces the current Front Side Bus. With the Intel X58 Express chipset built-in, the X8ST3-F/X8STE offers substantial enhancement in system performance with increased bandwidth and unprecedented scalability, optimized for intense-computing and high-end server platforms. Please refer to our web site (<http://www.supermicro.com/products/>) for updates on supported processors. This product is intended to be professionally installed and serviced by a technician.

### Manual Organization

**Chapter 1** describes the features, specifications and performance of the motherboard and provides detailed information about the chipset.

**Chapter 2** provides hardware installation instructions. Read this chapter when installing the processor, memory modules and other hardware components into the system. If you encounter any problems, see **Chapter 3**, which describes troubleshooting procedures for video, memory and system setup stored in the CMOS.

**Chapter 4** includes an introduction to the BIOS and provides detailed information on running the CMOS Setup utility.

**Appendix A** provides BIOS Error Beep Codes.

**Appendix B** lists the Windows OS Installation Instructions.

**Appendix C and Appendix D** lists Other Software Program Installation and BIOS Recovery Instructions.

## Conventions Used in the Manual:

Special attention should be given to the following symbols for proper installation and to prevent damage done to the components or injury to yourself:



**Danger/Caution:** Instructions to be strictly followed to prevent catastrophic system failure or to avoid bodily injury



**Warning:** Important information given to ensure proper system installation or to prevent damage to the components



**Note:** Additional Information given to differentiate various models or provides information for correct system setup.

## Contacting Supermicro

### Headquarters

Address: Super Micro Computer, Inc.  
980 Rock Ave.  
San Jose, CA 95131 U.S.A.

Tel: +1 (408) 503-8000

Fax: +1 (408) 503-8008

Email: marketing@supermicro.com (General Information)  
support@supermicro.com (Technical Support)

Web Site: www.supermicro.com

### Europe

Address: Super Micro Computer B.V.  
Het Sterrenbeeld 28, 5215 ML  
's-Hertogenbosch, The Netherlands

Tel: +31 (0) 73-6400390

Fax: +31 (0) 73-6416525

Email: sales@supermicro.nl (General Information)  
support@supermicro.nl (Technical Support)  
rma@supermicro.nl (Customer Support)

### Asia-Pacific

Address: Super Micro Computer, Inc.  
4F, No. 232-1, Liancheng Rd.  
Chung-Ho 235, Taipei County  
Taiwan, R.O.C.

Tel: +886-(2) 8226-3990

Fax: +886-(2) 8226-3991

Web Site: www.supermicro.com.tw

Technical Support:

Email: support@supermicro.com.tw

Tel: 886-2-8228-1366, ext.132 or 139

# Table of Contents

## **Preface**

About This Motherboard.....	3
Manual Organization .....	3
Conventions Used in the Manual:.....	4
Contacting Supermicro.....	5

## **Chapter 1 Introduction**

1-1 Overview .....	1-1
Checklist.....	1-1
Motherboard Features.....	1-6
1-2 Chipset Overview .....	1-11
1-3 PC Health Monitoring.....	1-12
Recovery from AC Power Loss.....	1-12
Onboard Voltage Monitoring .....	1-12
Fan Status Monitor with Software.....	1-12
CPU Overheat LED and Control .....	1-12
1-4 Power Configuration Settings.....	1-12
Slow Blinking LED for Suspend-State Indicator .....	1-12
BIOS Support for USB Keyboard.....	1-13
Main Switch Override Mechanism .....	1-13
Wake-On-LAN (WOL) .....	1-13
1-5 Power Supply .....	1-13
1-6 Super I/O.....	1-14
1-7 Overview of the Winbond WPCM450 Controller .....	1-14

## **Chapter 2 Installation**

2-1 Static-Sensitive Devices.....	2-1
Precautions .....	2-1
Unpacking .....	2-1
2-2 Processor and Heatsink Installation.....	2-2
Installing an LGA 1366 Processor .....	2-2
Installing a Passive CPU Heatsink (#SNK-P0037).....	2-4
2-3 Mounting the Motherboard into the Chassis.....	2-6
2-4 Installing and Removing the Memory Modules.....	2-7
Installing & Removing DIMMs.....	2-7
2-5 Connectors/IO Ports.....	2-10
Back Panel Connectors and IO Ports.....	2-10
ATX PS/2 Keyboard and PS/2 Mouse Ports.....	2-11

	Universal Serial Bus (USB).....	2-12
	Ethernet Ports .....	2-13
	Serial Ports.....	2-14
	Video Connector.....	2-15
	Front Control Panel.....	2-16
	Front Control Panel Pin Definitions.....	2-17
	NMI Button .....	2-17
	HDD LED.....	2-18
	NIC1/NIC2 LED Indicators .....	2-18
	Overheat (OH)/Fan Fail LED.....	2-19
	Power Fail LED .....	2-19
	Reset Button .....	2-20
	Power Button .....	2-20
2-6	Connecting Cables.....	2-21
	ATX Main PWR & CPU PWR Connectors .....	2-21
	Fan Headers.....	2-22
	Internal Buzzer .....	2-23
	Speaker .....	2-23
	Overheat/Fan Fail LED .....	2-24
	Chassis Intrusion .....	2-24
	Power Supply I <sup>2</sup> C Connector.....	2-25
	Onboard Power LED .....	2-25
	T-SGPIO 0/1 & 3-SGPIO 0/1 Headers.....	2-26
	Alarm Reset.....	2-26
	Wake-On-LAN .....	2-27
	I-Button.....	2-27
2-7	Jumper Settings .....	2-28
	Explanation of Jumpers .....	2-28
	LAN Port Enable/Disable .....	2-28
	CMOS Clear.....	2-29
	Watch Dog Enable/Disable .....	2-29
	SMB to PCI-X/PCI-E Slots Speeds.....	2-30
	(BMC) VGA Enable .....	2-30
	USB Wake-Up .....	2-31
	SAS Enable/Disable (X8ST3-F Only).....	2-32
	SAS RAID Mode Select (X8ST3-F Only).....	2-32
	BMC IPMI Enable (X7ST3-F only).....	2-33
2-8	Onboard Indicators.....	2-34
	LAN 1/LAN 2 LEDs .....	2-34

	IPMI Dedicated LAN LEDs (X8ST3-F Only) .....	2-34
	SAS Activity LED (X8ST3-F Only) .....	2-35
	SAS Heartbeat LED (X8ST3-F Only).....	2-35
	Onboard Power LED .....	2-36
2-9	Serial ATA and Floppy Drive Connections .....	2-37
	SATA Connectors .....	2-37
	Floppy Connector.....	2-38

**Chapter 3 Troubleshooting**

3-1	Troubleshooting Procedures .....	3-1
	Before Power On .....	3-1
	No Power .....	3-1
	No Video .....	3-1
	Memory Errors .....	3-2
	Losing the System's Setup Configuration.....	3-2
3-2	Technical Support Procedures.....	3-2
3-3	Frequently Asked Questions.....	3-3
3-4	Returning Merchandise for Service.....	3-5

**Chapter 4 BIOS**

4-1	Introduction.....	4-1
	Starting BIOS Setup Utility.....	4-1
	How To Change the Configuration Data .....	4-1
	How to Start the Setup Utility .....	4-2
4-2	Main Setup.....	4-2
4-3	Advanced Setup Configurations.....	4-4
4-4	Security Settings .....	4-23
4-5	Boot Configuration .....	4-24
4-6	Exit Options.....	4-25

**Appendix A POST Error Beep Codes**

	Recoverable POST Error Beep Codes .....	A-1
--	---	-----

**Appendix B Installing the Windows OS**

B-1	Installing the Windows OS for Systems with RAID Functions.....	B-1
B-2	Installing the Windows OS for Systems without RAID Functions.....	B-2

**Appendix C Software Installation Instructions**

C-1	Installing Drivers.....	C-1
C-2	Configuring SuperoDoctor III .....	C-2

**Appendix D - BIOS Recovery**

D-1	Recovery Process from a USB Device/Drive (Recommended Method).....	1
D-2	Recovery Process from an IDE/SATA ATAPI Disc Drive .....	2



# Chapter 1

## Introduction

### 1-1 Overview

#### Checklist

Congratulations on purchasing your computer motherboard from an acknowledged leader in the industry. Supermicro boards are designed with the utmost attention to detail to provide you with the highest standards in quality and performance.

Please check that the following items have all been included with your motherboard. If anything listed here is damaged or missing, contact your retailer.

The following items are included in the retail box.

- One (1) Supermicro Mainboard
- Six (6) SATA cables (CBL-0044L)
- One (1) floppy drive ribbon cable (CBL-022L)
- One (1) I/O shield (MCP-260-00027-0N)
- One (1) Supermicro CD containing drivers and utilities (CDR-X8-UP)
- One (1) User's/BIOS Manual (MNL-1040)

SUPER X8ST3-F Image

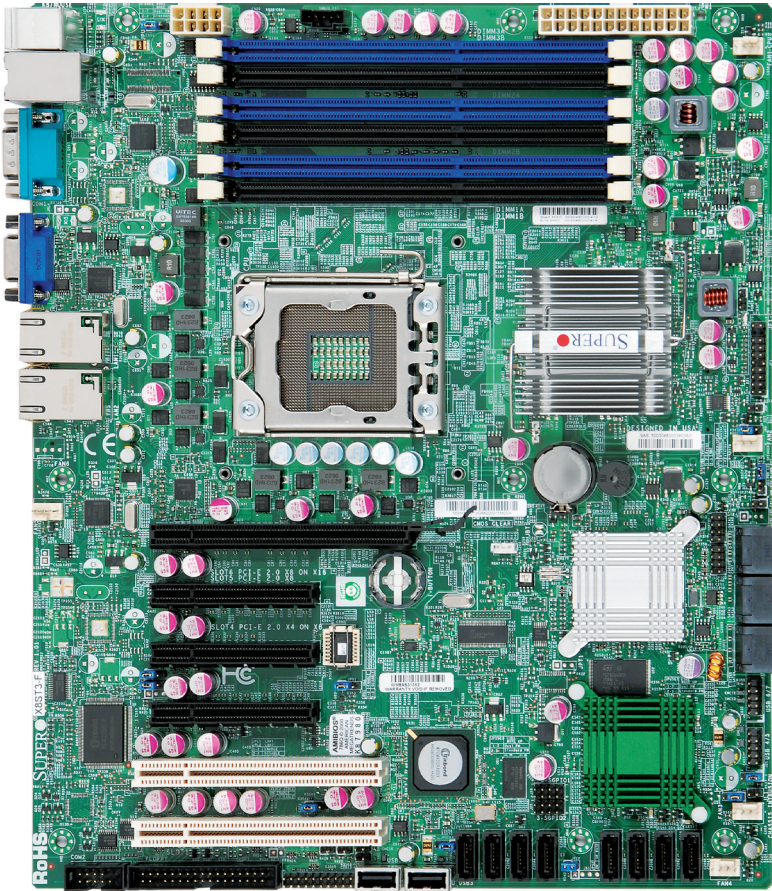

**Note:** All graphics shown in this manual were based upon the latest PCB Revision available at the time of publishing of the manual. The motherboard you've received may or may not look exactly the same as the graphics shown in this manual.



X8ST3-F/X8STE Quick Reference

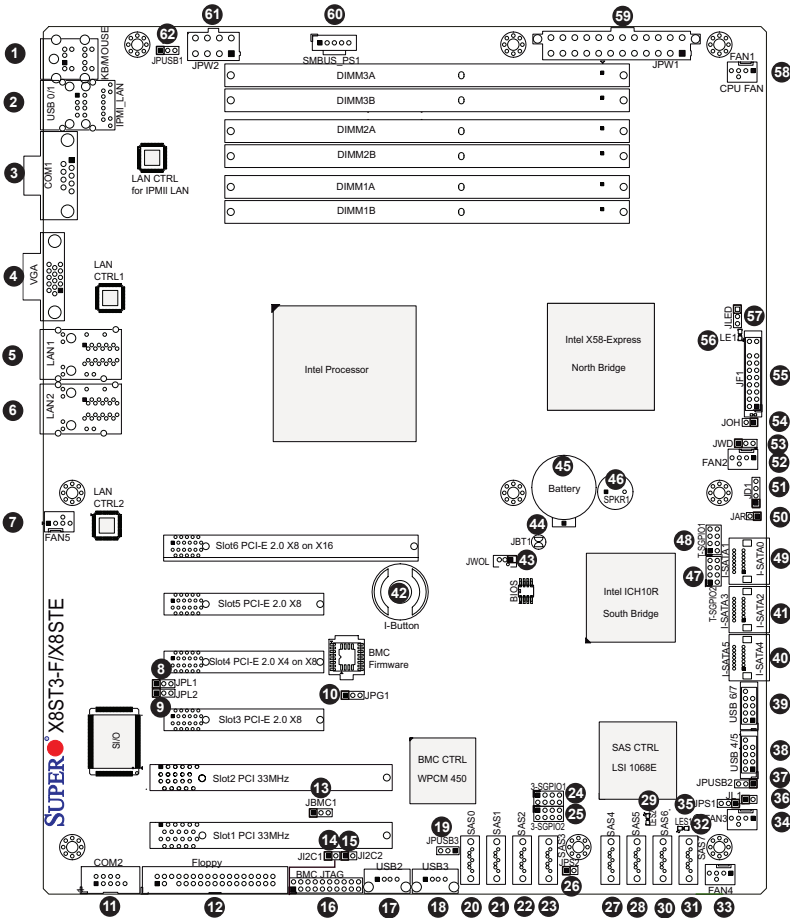

X8ST3-F/X8STE Jumpers

Jumper	Label	Description	Default Setting
JBMC1	#13	BMC Enable	Pins 1-2 (Enabled)
JBT1	#44	CMOS Clear	(See Chpt. 2)
J <sup>2</sup> C1/J <sup>2</sup> C2	#14, 15	SMB to PCI Slots	(See Chpt. 2)
JPG1	#10	VGA Enable	Pins 1-2 (Enabled)
JPL1/JPL2	#8, 9	LAN 1/2 Enable	Pins 1-2 (Enabled)
JPS1	#35	SAS Enable (X8ST3-F)	Pins 1-2 (Enabled)
JPS2	#26	SAS RAID Mode (X8ST3-F)	On (Software RAID)
JPUSB1	#62	BP USB0/1 Wake-up	Pins 1-2 (Enabled)
JPUSB2	#37	FP USB 4/5, 6/7 Wake-up	Pins 1-2 (Enabled)

**X8ST3-F/X8STE Jumpers**

JUSB3	#19	FP USB 2, 3 Wake-up	Pins 1-2 (Enabled)
JWD	#53	Watch Dog Timer Enable	Pins 1-2 (Reset)

**X8ST3-F/X8STE Headers/Connectors**

Connector	Label	Description
Battery	#45	Onboard battery (B1)
COM1/COM2	#3, 11	COM1/2 Serial connection headers
Fans 1~5	#58, 52, 34, 33, 7	System/CPU fan headers (Fan 1: CPU fan)
Floppy	#12	Floppy Disk Drive connector
I-Button	#42	I-Button for RAID data storage
JAR	#50	Alarm Reset
JD1	#51	Speaker header (Pins 3/4: Internal, 1~4:External)
JF1	#55	Front Panel Control header
JL1	#36	Chassis Intrusion header
JLED	#57	Power LED Indicator header
JOH	#54	Overheat LED header
JPW1	#59	24-pin ATX main power connector (required)
JPW2	#61	+12V 8-pin CPU power connector (required)
JWOL	#43	Wake-On-LAN header
KB/Mouse	#1	Keyboard/mouse connectors
LAN1/LAN2	#5, 6	Gigabit Ethernet (RJ45) ports
(IPMI) LAN	#2	IPMI Dedicated LAN (X8ST3-F only)
I-SATA 0~5	#40, 41, 49	Serial_ATA ports
SAS 0~3, 4~7	#20~23, 27, 28, 30, 31	Serial Attached SCSI Ports (X8ST3-F only)
SMB_PS1	#60	PWR supply (I <sup>2</sup> C) System Management Bus
SPKR1	#46	Internal speaker/buzzer
3-SGPIO-0/1	#24, 25	Serial_link IO headers for SAS (X8ST3-F)
T-SGPIO-0/1	#48, 47	Serial General Purpose IO headers (for SATA)
USB 0~1	#2	(Backpanel) Universal Serial Bus (USB) ports
USB 2, USB 3,	#17, 18, 38, 39	Front panel accessible USB headers
USB4/5, 6/7		
VGA	#4	Video Port

**X8ST3-F/X8STE LED Indicators**

LED	Label	Description
LE1	#56	Onboard Standby PWR warning LED Indicator
LES1	#32	SAS Activity (Blinking: SAS Active) (X8ST3-F only)
LES2	#29	SAS Heartbeat (Blinking: SAS Normal) (X8ST3-F only)

## Motherboard Features

### CPU

- Single Intel<sup>®</sup> Core™ i7 990X, i7-980X, i7-975, i7-965 Extreme Edition, Intel<sup>®</sup> Xeon<sup>®</sup> 5600/5500 series and Intel<sup>®</sup> Xeon<sup>®</sup> 3600/3500 series.

### Memory

- Six 240-pin, DDR3 SDRAM DIMM sockets with support for unbuffered ECC or non ECC 1333/1066/800 MHz memory.



**Note:** Both Unbuffered ECC and Non-ECC DIMM modules are supported by the motherboard. Using ECC or Non-ECC memory on your motherboard depends on the CPU installed. Please see page 3-3 for more information on memory support.

- Supports 3-channel memory bus
- DIMM sizes of 256 MB, 512 MB, 1 GB, 2 GB, and 4 GB are supported

### Chipset

- Intel<sup>®</sup> X58 Express Chipset (IOH)
- Intel ICH10R (South Bridge)

### Expansion Slots

- One (1) PCI-Express x8 Gen2 on x16 slot (Slot 6)
- Two (2) PCI-Express x8 Gen2 slots (Slot 3/Slot 5)
- One PCI-Express x4 Gen2 on x8 slot (Slot 4)
- Two (2) 32-bit PCI 33MHz slots (Slot 1/Slot 2)

### Graphics

- Support for multiple PCI-Express Graphics cards (Gen 2 or Gen 1)
- Matrox G200 with 16 MB DDR2 Memory

### Network Connections

- Intel Dual-channel 82574L Gigabit (10/100/1000 Mb/s) Ethernet Controller with two Gigabit LAN ports (LAN 1 and LAN 2)
- Realtek RTL8201N PHY (Dedicated LAN for X8ST3-F)
- Three (3) RJ-45 backplane connectors with Link and Activity LEDs built-in

### I/O Devices

#### SATA Connections

- Six (6) SATA ports supported by the Intel ICH10R SATA Controller
- Supports RAID 0, 1, 5, 10 under the Windows OS environment

- Supports RAID 0, 1 , 10 under the Linux OS environment

#### **SAS Connections (for the X8ST3-F only)**

- Eight (8) SAS ports supported by the LSI 1068E Controller
- Supports RAID 0, 1, 5\*, 10 under the Windows OS environment
- Supports RAID 0, 1 , 5\*, 10 under the Linux OS environment



#### **Notes:**

1. RAID 5 is supported when the I-Button (AOC-IButton68) is installed on the motherboard. For more information on the AOC-IButton68, please refer to <http://www.supermicro.com/products/accessories/addon/AOC-IButton68.cfm>.
2. For the LSI 1068 Controller User's Guide, please refer to <http://www.supermicro.com/support/manuals/>.

#### **Integrated IPMI 2.0 (for the X8ST3-F only)**

- IPMI 2.0 supported by the WPCM450 Server BMC



**Note:** For IPMI Configuration Instructions, please refer to the Embedded IPMI Configuration User's Guide available @ <http://www.supermicro.com/support/manuals/>.

### **Floppy Drive**

- One (1) floppy port interface (up to 1.44 MB)

#### **USB Devices**

- Two (2) USB ports (USB 0~1) on the IO backplane for rear access
- Six (6) USB connections for front access (Two Type A connectors: USB 2, USB 3 and two headers: USB 4/5, 6/7)

#### **Keyboard/Mouse**

- PS/2 Keyboard/Mouse ports on the I/O backplane

#### **Serial (COM) Ports**

- Fast UART 16550 Connections: one COM port and one header

#### **Super I/O**

- Winbond Super I/O 83627DHG

### **BIOS**

- 32 MBit SPI AMI BIOS® SM Flash BIOS
- DMI 2.3, PCI 2.3, ACPI 1.0/2.0/3.0, USB Keyboard and SMBIOS 2.5

## **Power Configuration**

- ACPI/ACPM Power Management
- Main switch override mechanism
- Keyboard Wake-up from Soft-Off
- USB Wake-up from Soft-Off
- Wake-on-LAN
- Power-on mode for AC power recovery

## **PC Health Monitoring**

### **CPU Monitoring**

- Onboard voltage monitors for CPU core, Memory Voltage, Chipset Voltage, +1.8V, +3.3V, +3.3V standby, +5V, +5V, Standby, VBat and  $\pm 12V$
- CPU 6-Phase-switching voltage regulator
- CPU/System overheat LED and control
- CPU Thermal Trip support
- Thermal Monitor 2 (TM2) support

### **Fan Control**

- Fan status monitoring with firmware 4-pin (Pulse Width Modulation) fan speed control
- Low noise fan speed control

## **System Management**

- PECI (Platform Environment Configuration Interface) support
- System resource alert via Supero Doctor III
- SuperoDoctor III, Watch Dog, NMI
- I<sup>2</sup>C temperature sensing logic
- Chassis Intrusion Header and Detection
- Pb Free

## **CD Utilities**

- BIOS flash upgrade utility
- Drivers and software for Intel® X58 Express chipset utilities

## **Dimensions**

- ATX form factor, 12" x 10" (304.8 x 254.0 mm)



## Notes



## 1-2 Chipset Overview

Built upon the functionality and the capability of the Intel X58 Express chipset, the X8ST3-F/X8STE motherboard provides the performance and feature set required for single-processor-based high-end systems with configuration options optimized for intensive application and high-end server platforms.

The main architecture of the X8ST3-F/X8STE consists of an Intel® Core™ i7 or an Intel Xeon 5500/3500 Processor in an LGA1366 socket, the Intel X58 Express chipset, and the ICH10R. With Intel QuickPath Interconnect (QPI) technology built in, the X8ST3-F/X8STE is one of the first motherboards on the market that offers the next generation point-to-point system interconnect interface, replacing the current Front Side Bus technology, providing substantial system performance enhancement by utilizing serial link interconnections to increase bandwidth and scalability.

## 1-3 PC Health Monitoring

This section describes the PC health monitoring features of the X8ST3-F/X8STE. These features are supported by an onboard System Hardware Monitor chip.

### Recovery from AC Power Loss

BIOS provides a setting for you to determine how the system will respond when AC power is lost and then restored to the system. You can choose for the system to remain powered off (in which case you must hit the power switch to turn it back on) or for it to automatically return to a power on state. See the Power Lost Control setting in the BIOS chapter of this manual to change this setting. The default setting is **Last State**.

### Onboard Voltage Monitoring

The onboard voltage monitor will scan the following voltages continuously: CPU Core, Chipset Voltage, Memory Voltage, +1.8V, +3.3V, +3.3V standby, +5V, +5V Standby, Vbat and  $\pm 12V$ . Once a voltage becomes unstable, it will give a warning or send an error message to the screen. Users can adjust the voltage thresholds to define the sensitivity of the voltage monitor by using SD III.

### Fan Status Monitor with Software

PC health monitoring can check the RPM status of the cooling fans via Supero Doctor III.

### CPU Overheat LED and Control

This feature is available when the user enables the CPU overheat warning feature in the BIOS. This allows the user to define an overheat temperature. When this temperature reaches this pre-defined overheat threshold, the CPU thermal trip feature will be activated and it will send a signal to the buzzer and, at the same time, the CPU speed will be decreased.

## 1-4 Power Configuration Settings

This section describes the features of your motherboard that deal with power and power settings.

### Slow Blinking LED for Suspend-State Indicator

When the CPU goes into a suspend state, the chassis power LED will start blinking to indicate that the CPU is in the suspend mode. When the user presses any

key, the CPU will wake-up and the LED indicator will automatically stop blinking and remain on.

## BIOS Support for USB Keyboard

If the USB keyboard is the only keyboard in the system, it will function like a normal keyboard during system boot-up.

## Main Switch Override Mechanism

When an ATX power supply is used, the power button can function as a system suspend button. When the user presses the power button, the system will enter a SoftOff state. The monitor will be suspended and the hard drive will spin down. Pressing the power button again to wake-up the whole system. During the SoftOff state, the ATX power supply provides power the system to keep the required circuitry "alive". In case the system malfunctions and you want to turn off the power, just press and hold the power button for 4 seconds. The power will turn off and no power will be provided to the motherboard.

## Wake-On-LAN (WOL)

Wake-On-LAN is defined as the ability of a management application to remotely power up a computer that is powered off. Remote PC setup, up-dates and asset tracking can occur after hours and on weekends so that daily LAN traffic is kept to a minimum and users are not interrupted. The motherboard has a 3-pin header (WOL) to connect to the 3-pin header on a Network Interface Card (NIC) that has WOL capability. In addition, an onboard LAN controller can also support WOL without any connection to the WOL header. The 3-pin WOL header is to be used with a LAN add-on card only.



**Note:** Wake-On-LAN requires an ATX 2.01 (or above) compliant power supply.

## 1-5 Power Supply

As with all computer products, a stable power source is necessary for proper and reliable operation. It is even more important for processors that have high CPU clock rates of 1 GHz and faster.

The **SUPER** X8ST3-F/X8STE accommodates ATX12V standard power supplies. Although most power supplies generally meet the specifications required by the CPU, some are inadequate. A 2-Amp of current supply on a 5V Standby rail is strongly recommended.

It is strongly recommended that you use a high quality power supply that meets ATX12V standard power supply Specification 1.1 or above. It is also required that the 12V 8-pin power connection (JPW2) be used for adequate power supply. In areas where noisy power transmission is present, you may choose to install a line filter to shield the computer from noise. It is recommended that you also install a power surge protector to help avoid problems caused by power surges.

## 1-6 Super I/O

The disk drive adapter functions of the Super I/O chip include a floppy disk drive controller that is compatible with industry standard 82077/765, a data separator, write pre-compensation circuitry, decode logic, data rate selection, a clock generator, drive interface control logic and interrupt and DMA logic. The wide range of functions integrated onto the Super I/O greatly reduces the number of components required for interfacing with floppy disk drives. The Super I/O supports two 360 K, 720 K, 1.2 M, 1.44 M or 2.88 M disk drives and data transfer rates of 250 Kb/s, 500 Kb/s or 1 Mb/s.

It also provides two high-speed, 16550 compatible serial communication ports (UARTs). Each UART includes a 16-byte send/receive FIFO, a programmable baud rate generator, complete modem control capability and a processor interrupt system. Both UARTs provide legacy speed with baud rate of up to 115.2 Kbps as well as an advanced speed with baud rates of 250 K, 500 K, or 1 Mb/s, which support higher speed modems.

The Super I/O provides functions that comply with ACPI (Advanced Configuration and Power Interface), which includes support of legacy and ACPI power management through a SMI or SCI function pin. It also features auto power management to reduce power consumption.

## 1-7 Overview of the Winbond WPCM450 Controller

The Winbond WPCM450, a Baseboard Management Controller (BMC), supports the 2D/VGA-compatible Graphics Core with the PCI interface, Virtual Media, and Keyboard/Video/Mouse (KVM) Redirection modules.

The WPCM450 BMC interfaces with the host system via a PCI interface to communicate with the graphics core. It supports USB 2.0 and 1.1 for remote keyboard/mouse/virtual media emulation. It also provides LPC interface to control Super IO functions. The WPCM450 is connected to the network via an external Ethernet PHY module.

The WPCM450 communicates with onboard components via six SMBus interfaces, fan control, Platform Environment Control Interface (PECI) buses, and General Purpose I/O (3SGPIO) ports.

The WPCM450 also includes the following features:

- One X-Bus parallel interface for expansion I/O connections
- Three ADC inputs, Analog and Digital Video outputs
- Two serial for boundary scan and debug



**Note:** For more information on IPMI configuration, please refer to the Embedded IPMI User's Guide posted on our website @ <http://www.supermicro.com/support/manuals/>.

## Notes



## Chapter 2

### Installation

#### 2-1 Static-Sensitive Devices

Electrostatic-Discharge (ESD) can damage electronic components. To prevent damage to your system board, it is important to handle it very carefully. The following measures are generally sufficient to protect your equipment from ESD.

##### **Precautions**

- Use a grounded wrist strap designed to prevent static discharge.
- Touch a grounded metal object before removing the board from the antistatic bag.
- Handle the board by its edges only; do not touch its components, peripheral chips, memory modules or gold contacts.
- When handling chips or modules, avoid touching their pins.
- Put the motherboard and peripherals back into their antistatic bags when not in use.
- For grounding purposes, make sure your computer chassis provides excellent conductivity between the power supply, the case, the mounting fasteners and the motherboard.
- Use only the correct type of onboard CMOS battery. Do not install the onboard upside down battery to avoid possible explosion.

##### **Unpacking**

The motherboard is shipped in antistatic packaging to avoid static damage. When unpacking the board, make sure the person handling it is static protected.

## 2-2 Processor and Heatsink Installation



When handling the processor package, avoid placing direct pressure on the label area of the fan.

### Notes:

1. Always connect the power cord last and always remove it before adding, removing or changing any hardware components. Make sure that you install the processor into the CPU socket before you install the CPU heatsink.
2. Intel's boxed processor package contains the CPU fan and heatsink assembly. If you buy a CPU separately, make sure that you use only Intel-certified multi-directional heatsink and fan.
3. Make sure to install the motherboard into the chassis before you install the CPU heatsink and heatsink fans.
4. When purchasing an LGA 1366 processor or when receiving a motherboard with an LGA 1366 processor pre-installed, make sure that the CPU plastic cap is in place, and none of the CPU pins are bent; otherwise, contact the retailer immediately.
5. Refer to the MB Features Section for more details on CPU support.

### Installing an LGA 1366 Processor

1. Press the socket clip to release the load plate, which covers the CPU socket, from its locking position.
2. Gently lift the socket clip to open the load plate.
3. Hold the plastic cap at its north and south center edges to remove it from the CPU socket.



**Note:** The photos on this page and succeeding pages 2-3 through 2-9 are for illustration purposes only. They do not necessarily reflect the exact product(s) described in this manual.



**Socket Clip**

**Load Plate**



**Plastic Cap**

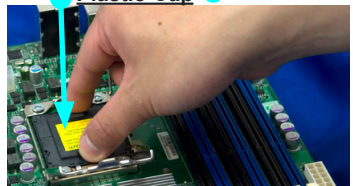

**Hold the north & south edges of the plastic cap to remove it**

4. After removing the plastic cap, using your thumb and the index finger, hold the CPU at the north and south center edges.
5. Align the CPU key, the semi-circle cutout, against the socket key, the notch below the gold color dot on the side of the socket.
6. Once both the CPU and the socket are aligned, carefully lower the CPU straight down into the socket. (Do not rub the CPU against the surface of the socket or its pins to avoid damaging the CPU or the socket.)
7. With the CPU inside the socket, inspect the four corners of the CPU to make sure that the CPU is properly installed.
8. Once the CPU is securely seated on the socket, lower the CPU load plate to the socket.
9. Use your thumb to gently push the socket clip down to the clip lock.



**Warning:** Please save the plastic cap. The motherboard must be shipped with the plastic cap properly installed to protect the CPU socket pins. Shipment without the plastic cap properly installed will cause damage to the socket pins.

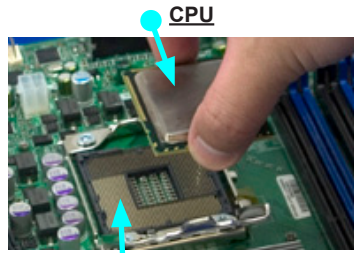

**CPU Socket**

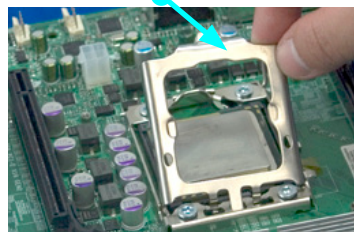
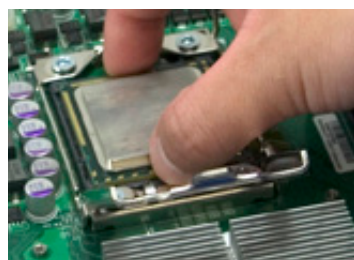
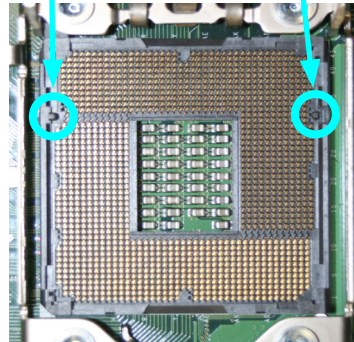
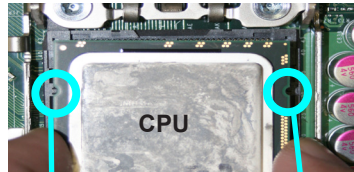

## Installing a Passive CPU Heatsink (#SNK-P0037)



**Note:** A heatsink bracket (BKT-0023L) is required for a screw-type heatsink (-which is a non-pushpin heatsink as shown on the right.) The required heatsink bracket (BKT-0023L) can be purchased from Supermicro.



**Note:** Do not apply any thermal grease to the heatsink or the CPU die because the required amount has already been applied.

1. If you use a screw-type heatsink, please install a heatsink bracket (BKT-0023L) on the reverse side of the motherboard before installing the heatsink. (To install the heatsink bracket, please insert four screws to the mounting holes to secure the bracket on the motherboard.) If you do not use a screw-type heatsink, please skip this step.
2. Place the heatsink on top of the CPU so that the four mounting holes are aligned with those on the bracket now located underneath.
3. Install two diagonal screws (i.e., the #1 and the #2 screws) until secure. However, leave each loosely tightened until all four screws are in place.

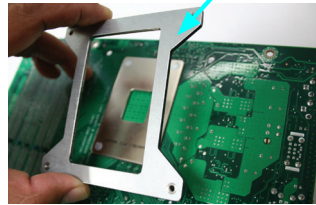
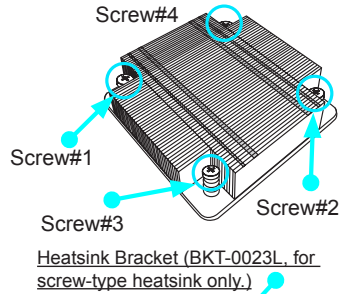

Install the Heatsink Bracket on the reverse side of the board.

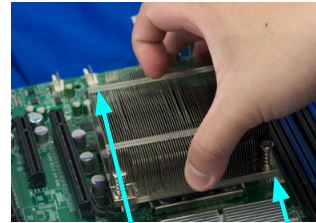

Install Screw#1

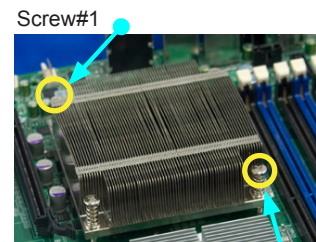
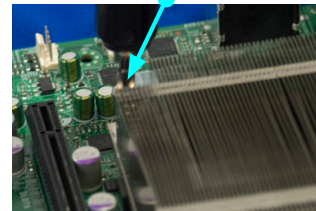

Install Screw#2

4. Finish the installation by fully tightening all four screws. Do not over-tighten to avoid possible damage to the CPU.

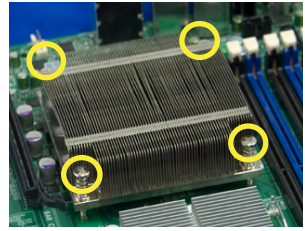

### Passive Heatsink Removal

1. Unplug the power cord from the power supply.
2. Using a screwdriver, loosen and remove the heatsink screws from the motherboard in the sequence as shown in the picture on the right.
3. Hold the heatsink as shown and gently loosen it from the CPU by moving it from side to side. (Do not use excessive force)
4. Once it is loosened, remove the heatsink from the CPU socket.
5. To reinstall the CPU and the heatsink, clean the surface of the CPU and the heatsink to remove the old thermal grease. Reapply the proper amount of thermal grease on the surface before reinstalling them on the motherboard.

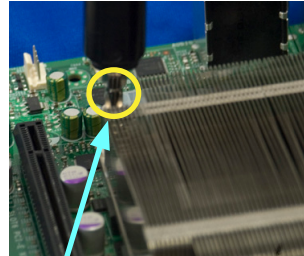

Using a screwdriver to  
Remove Screw#1

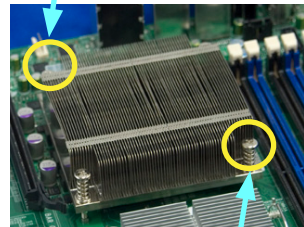

Remove Screw#2

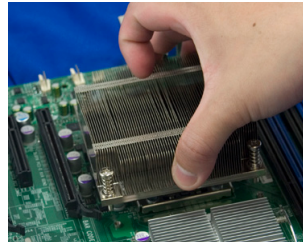

## 2-3 Mounting the Motherboard into the Chassis

All motherboards have standard mounting holes to fit different types of chassis. Make sure that the locations of all mounting holes for the motherboard and the chassis match. Although a chassis may have both plastic and metal mounting fasteners, metal ones are highly recommended because they ground the motherboard to the chassis. Make sure that the metal standoffs click in or are screwed in tightly. Then use a screwdriver to secure the motherboard onto the motherboard tray. (See the layout on the right for mounting hole locations.)



**Note:** Some components are very close to the mounting holes. Please take all necessary precautionary measures to avoid damaging these components when installing the motherboard into the chassis.

### Tools Needed

- Phillips Screwdriver



- (9) Pan head #6 screws



### Installation Instructions

1. Install the I/O shield in your chassis. This is provided with your motherboard.
2. Locate the mounting holes on the motherboard. Refer to the layout on the right for mounting hole locations.
3. Place Standoffs on the chassis as needed.
4. Place the motherboard inside the chassis.
5. Locate the matching mounting holes on the chassis. Align the mounting holes on the motherboard against the mounting holes on the chassis.
6. Insert a Pan head #6 screw into a mounting hole on the motherboard and its matching mounting hole on the chassis, using a Phillips screwdriver.
7. Repeat Step 6 until all mounting holes are secured.

**Location of Mounting Holes**

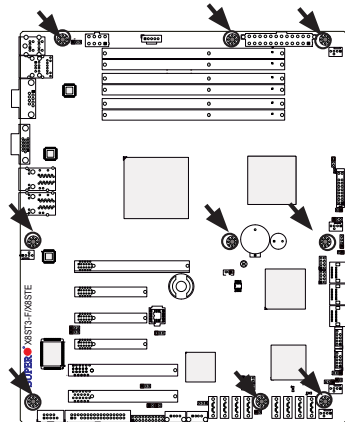

**Caution:** To avoid damaging the motherboard and its components, please do not use a force greater than 8 lb/inch on each mounting screw during motherboard installation.



## 2-4 Installing and Removing the Memory Modules

**Note:** Check the Supermicro web site for recommended memory modules.



**CAUTION** Exercise extreme care when installing or removing DIMM modules to prevent any possible damage.

### Installing & Removing DIMMs

1. Insert the desired number of DIMMs into the memory slots, starting with DIMM1A. When populating multiple DIMM modules within a channel, always start with Bank1 first. (For best performance, please use the memory modules of the same type and same speed in the same bank.)
2. Press down the release tabs on the ends of a memory slot. Insert each DIMM module vertically into its slot. Pay attention to the notch along the bottom of the module to prevent inserting the DIMM module incorrectly.
3. Gently press down on the DIMM module until it snaps into place in the slot. Repeat for all modules.
4. Reverse the steps above to remove the DIMM modules from the motherboard.

Press down the release tabs

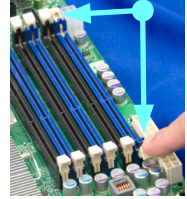

Insert & press down a DIMM module into the slot

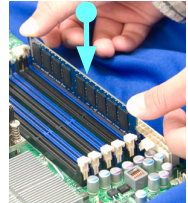

### Installing and Removing DDR3 Memory

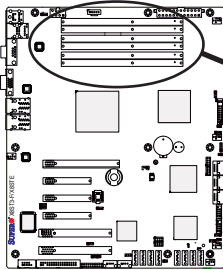

#### To Remove:

Use your thumbs to gently push the release tabs near both ends of the module. This should release it from the slot.

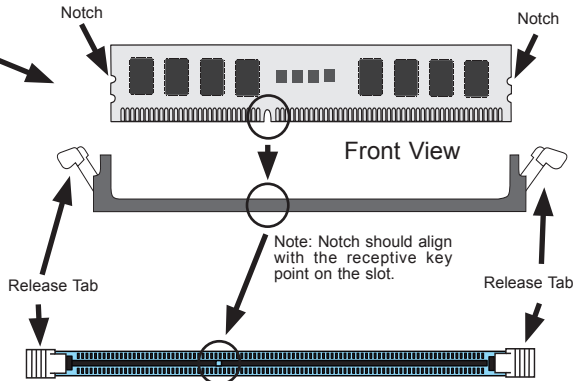

#### Top View of DDR3 Slot

**To Install:** Insert module vertically and press down until it snaps into place. Pay attention to the alignment notch at the bottom.

## Memory Support

The X8ST3-F/X8STE supports up to 24 GB Unbuffered ECC or Non ECC DDR3 1333/1066/800 in 6 DIMM slots.

### DIMM Module Population Configuration

For memory to work properly, follow the table below for memory installation:

Memory Population (UDIMM Only Routing)				
DIMM Slots per Channel	DIMMs Populated per Channel	DIMM Type	POR Speeds (in MHz)	Ranks per DIMM (any combination; SR=Single Rank, DR=Dual Rank)
2	1	Unbuffered DDR3 (with or without ECC)	800,1066,1333	SR, DR
2	2	Unbuffered DDR3 (with or without ECC)	800,1066,	SR, DR

**Population Rules:** Any combination of x8 and x16 UDIMMs, with 1Gb or 2Gb DRAM density.

Memory Population (UDIMM 3 DIMMs per Channel Routing)				
DIMM Slots per Channel	DIMMs Populated per Channel	DIMM Type	POR Speeds (in MHz)	Ranks per DIMM (any combination; SR=Single Rank, DR=Dual Rank)
3	1	Unbuffered DDR3 (with or without ECC)	800,1066,1333	SR, DR
3	2	Unbuffered DDR3 (with or without ECC)	800,1066,	SR, DR

**Population Rules:** Any combination of x8 UDIMMs, with 1Gb or 2Gb DRAM density.

### Maximum Memory Possible

Single Rank UDIMMs - 12GB (6x 2GB DIMMs), Dual Rank UDIMMs - 24GB (6x 4GB DIMMs)



**Note 1:** Both Unbuffered ECC and Non-ECC DIMM modules are supported by the motherboard. Using ECC or Non-ECC memory on your motherboard depends on the CPU installed.

**Note 2:** Due to OS limitations, some operating systems may not show more than 4 GB of memory.

**Note 3:** Due to memory allocation to system devices, the amount of memory that remains available for operational use will be reduced when 4 GB of RAM is used. The reduction in memory availability is disproportional. Refer to the table on the next page. For Microsoft Windows users: Microsoft implemented a design change in Windows XP with Service Pack 2 (SP2) and Windows Vista. This change is specific to the Physical Address Extension (PAE) mode behavior which improves driver compatibility. For more information, please read the following article at Microsoft's Knowledge Base website at: <http://support.microsoft.com/kb/888137>.



Possible System Memory Allocation & Availability		
System Device	Size	Physical Memory Remaining (-Available) (4 GB Total System Memory)
Firmware Hub flash memory (System BIOS)	1 MB	3.99 GB
Local APIC	4 KB	3.99 GB
Area Reserved for the chipset	2 MB	3.99 GB
I/O APIC (4 Kbytes)	4 KB	3.99 GB
PCI Enumeration Area 1	256 MB	3.76 GB
PCI Express (256 MB)	256 MB	3.51 GB
PCI Enumeration Area 2 (if needed) -Aligned on 256-MB boundary-	512 MB	3.01 GB
VGA Memory	16 MB	2.85 GB
TSEG	1 MB	2.84 GB
Memory available for the OS & other applications		2.84 GB

**Note :**

The motherboard will NOT boot if DIMM module(s) are installed in any of the Bank2 slots but none in the Bank1 slots. The first DIMM module must be installed in DIMM1A, and all Bank1 slots must be filled before populating any Bank2 slot(s).

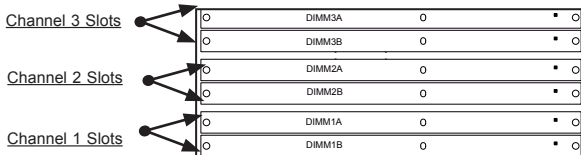

## 2-5 Connectors/IO Ports

The I/O ports are color coded in conformance with the PC 99 specification. See the figure below for the colors and locations of the various I/O ports.

### Back Panel Connectors and IO Ports

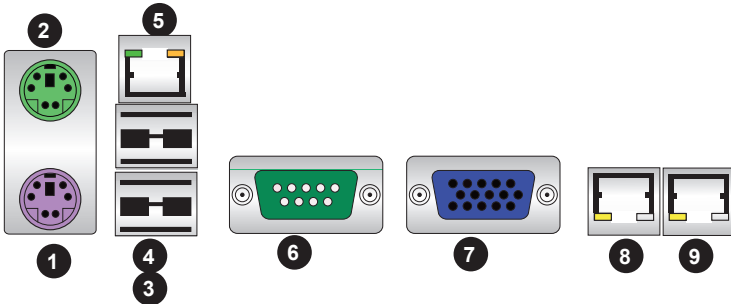
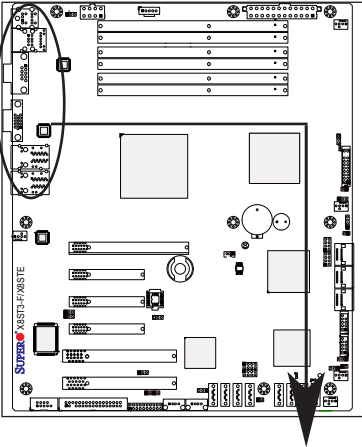

### Back Panel Connectors

1. Keyboard (Purple)
2. PS/2 Mouse (Green)
3. USB Port 0
4. USB Port 1
5. IPMI LAN (X8ST3-F)
6. COM 1
7. VGA
8. LAN1
9. LAN 2

## ATX PS/2 Keyboard and PS/2 Mouse Ports

The ATX PS/2 keyboard and PS/2 mouse are located next to the Back Panel USB Ports 0/1 on the motherboard. See the table at right for pin definitions.

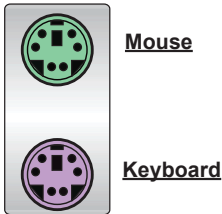

PS/2 Keyboard/Mouse Pin Definitions			
PS2 Keyboard		PS2 Mouse	
Pin#	Definition	Pin#	Definition
1	KB Data	1	Mouse Data
2	No Connection	2	No Connection
3	Ground	3	Ground
4	Mouse/KB VCC (+5V)	4	Mouse/KB VCC (+5V)
5	KB Clock	5	Mouse Clock
6	No Connection	6	No Connection

VCC: with 1.5A PTC (current limit)

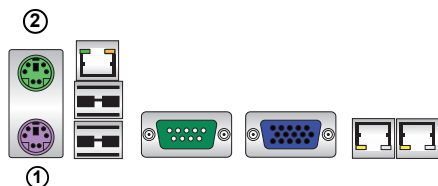
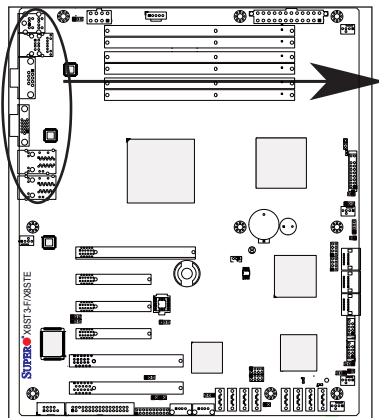

1. Keyboard (Purple)

2. Mouse (Green)

### Universal Serial Bus (USB)

Two Universal Serial Bus ports (USB 0/1) are located on the I/O back panel. Additional six USB connections (USB 2, USB 3, USB 4/5 and USB 6/7) are used to provide front chassis access. USB 2 and USB 3 are Type A Connectors. (USB Cables are not included). See the tables on the right for pin definitions.

Pin#	Definition	Pin#	Definition
1	+5V	5	+5V
2	USB_PN1	6	USB_PN0
3	USB_PP1	7	USB_PP0
4	Ground	8	Ground

USB 2, 3, 4, 6		USB 5, 7	
Pin #	Definition	Pin #	Definition
1	+5V	6	+5V
2	USB_PN2	7	USB_PN3
3	USB_PP2	8	USB_PP3
4	Ground	9	Ground
5	No Connection	10	Key

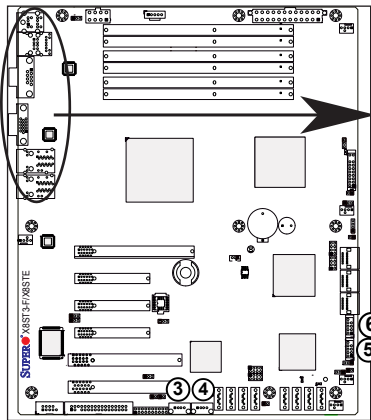

1. Backplane USB 0
2. Backplane USB 1
3. Front Panel USB 2
4. Front Panel USB 3
5. Front Panel USB 4/5
6. Front Panel USB 6/7

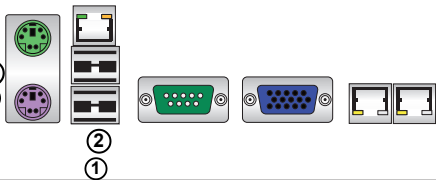

## Ethernet Ports

Two Ethernet ports are located next to the VGA port on the IO Backplane. In addition, an IPMI Dedicated LAN is located above the USB ports. These ports accept RJ45 type cables.



### Notes:

1. The IPMI Dedicated LAN is for the X8ST3-F only.
2. Please refer to the LED Indicator Section for LAN LED information.

LAN Ports Pin Definition			
Pin#	Definition		
1	P2V5SB	10	SGND
2	TD0+	11	Act LED
3	TD0-	12	P3V3SB
4	TD1+	13	Link 100 LED (Yellow, +3V3SB)
5	TD1-	14	Link 1000 LED (Yellow, +3V3SB)
6	TD2+	15	Ground
7	TD2-	16	Ground
8	TD3+	17	Ground
9	TD3-	88	Ground

(NC: No Connection)

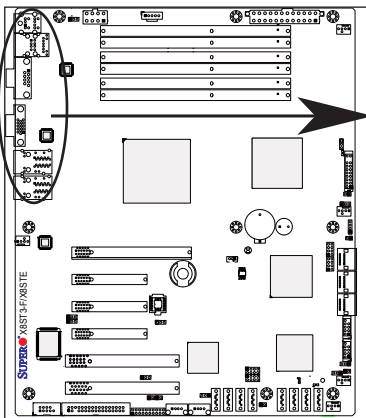

1. LAN1

2. LAN2

3. IPMI Dedicated LAN  
(X8ST3-F only)

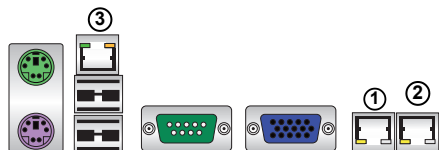

**Serial Ports**

A COM Port is located on the IO Backplane and a Serial port is located next to the Floppy Drive to provide front access. See the table on the right for pin definitions.

Serial Port Pin Definitions (COM1/COM2)			
Pin #	Definition	Pin #	Definition
1	CDC	6	DSR
2	RXD	7	RTS
3	TXD	8	CTS
4	DTR	9	RI
5	Ground	10	NC

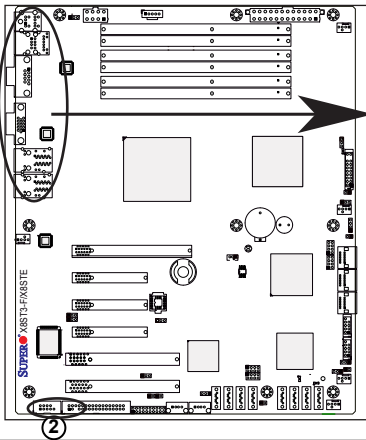

- 1. COM1
- 2. COM2

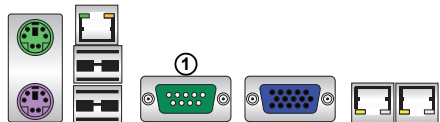

## Video Connector

A Video (VGA) connector is located next to the COM Port on the IO backplane. This connector is used to provide video and CRT display. Refer to the board layout below for the location.

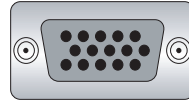

Note: If you decide use an add-on VGA card instead, you will need to disable this device using jumper JPG1. Please see page 1-4 for the jumper location.

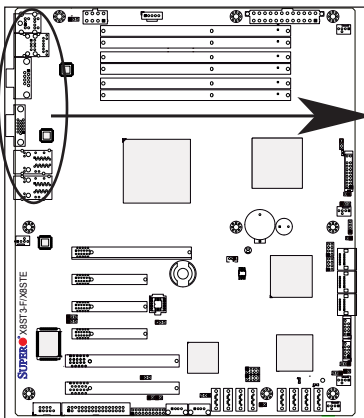

1. VGA

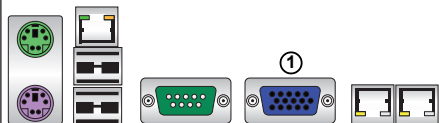

## Front Control Panel

JF1 contains header pins for various buttons and indicators that are normally located on a control panel at the front of the chassis. These connectors are designed specifically for use with Supermicro server chassis. See the figure below for the descriptions of the various control panel buttons and LED indicators. Refer to the following section for descriptions and pin definitions.

### JF1 Header Pins

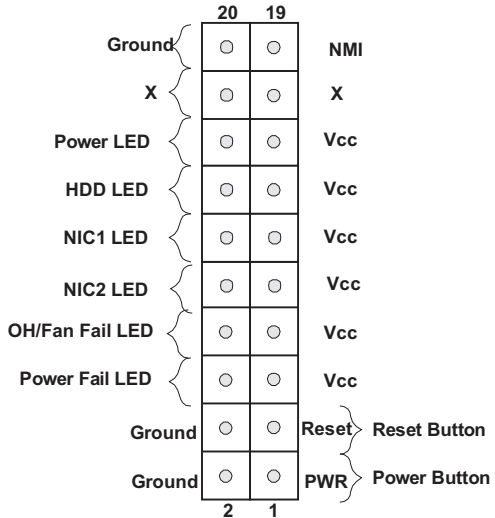
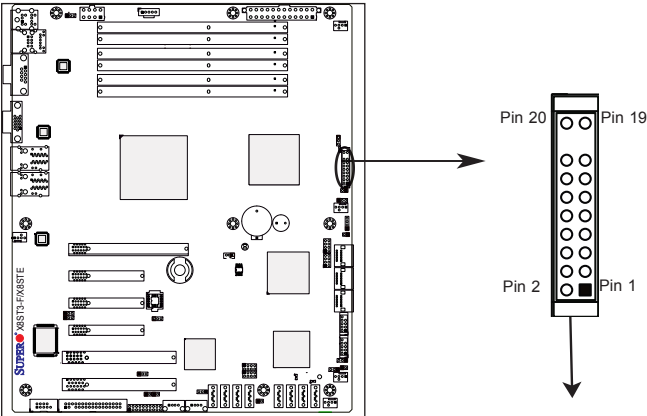





**HDD LED**

The HDD LED connection is located on pins 13 and 14 of JF1. Attach a hard drive LED cable here to display disk activity (for any hard drive activities on the system, including Serial ATA and IDE). See the table on the right for pin definitions.

HDD LED Pin Definitions (JF1)	
Pin#	Definition
13	+5V
14	HD Active

**NIC1/NIC2 LED Indicators**

The NIC (Network Interface Controller) LED connection for LAN port 1 is located on pins 11 and 12 of JF1, and the LED connection for LAN Port 2 is on Pins 9 and 10. Attach the NIC LED cables to display network activity. Refer to the table on the right for pin definitions.

GLAN1/2 LED Pin Definitions (JF1)	
Pin#	Definition
9/11	Vcc
10/12	Ground

- A. HDD LED
- B. NIC1 LED
- C. NIC2 LED

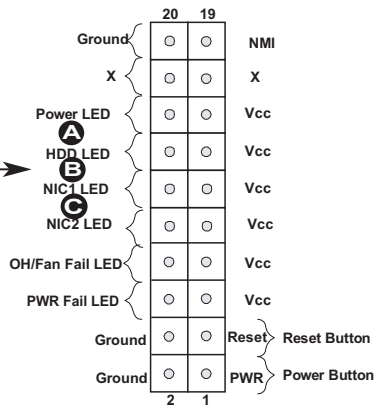
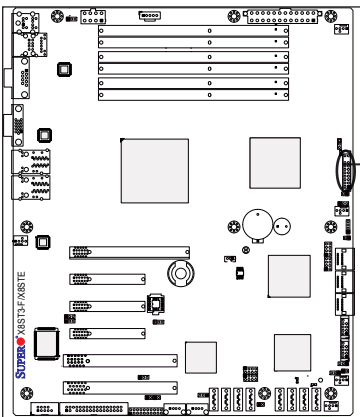



### Reset Button

The Reset Button connection is located on pins 3 and 4 of JF1. Attach it to a hardware reset switch on the computer case to reset the system. Refer to the table on the right for pin definitions.

Reset Button Pin Definitions (JF1)	
Pin#	Definition
3	Reset
4	Ground

### Power Button

The Power Button connection is located on pins 1 and 2 of JF1. Momentarily contacting both pins will power on/off the system. This button can also be configured to function as a suspend button (with a setting in the BIOS - see Chapter 4). To turn off the power in the suspend mode, press the button for at least 4 seconds. Refer to the table on the right for pin definitions.

Power Button Pin Definitions (JF1)	
Pin#	Definition
1	Signal
2	+3V Standby

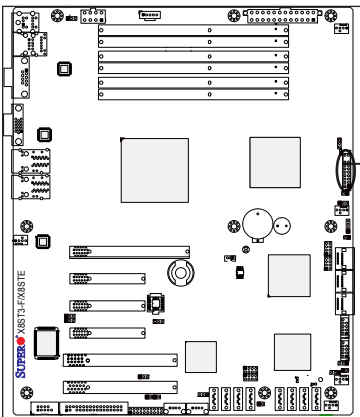

A. Reset Button

B. PWR Button

## 2-6 Connecting Cables

This section provides brief descriptions and pin-out definitions for onboard headers and connectors. Be sure to use the correct cable for each header or connector.

- For information on Backpanel USB and Front Panel USB ports, refer to Page 2-14.
- For information on COM Port 1 and COM Port 2, please see Page 2-16.

### ATX Main PWR & CPU PWR Connectors

The 24-pin main power connector (JPW1) is used to provide power to the motherboard. The 8-pin CPU PWR connector (JPW2) is also required for the processor. These power connectors meet the SSI EPS 12V specification. See the table on the right for pin definitions.

Pin#	Definition	Pin #	Definition
13	+3.3V	1	+3.3V
14	-12V	2	+3.3V
15	COM	3	COM
16	PS_ON	4	+5V
17	COM	5	COM
18	COM	6	+5V
19	COM	7	COM
20	Res (NC)	8	PWR_OK
21	+5V	9	5VSB
22	+5V	10	+12V
23	+5V	11	+12V
24	COM	12	+3.3V

### 12V 8-pin Power Connector Pin Definitions (JPW3)

Pins	Definition
1 through 4	Ground
5 through 8	+12V

(Required)

A. 24-Pin ATX Main PWR

B. 8-Pin Processor PWR

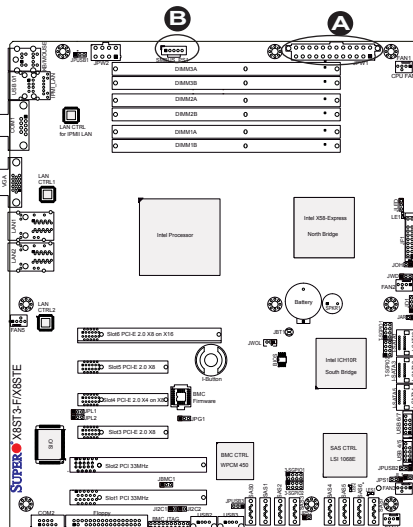

Fan Headers

The X8ST3-F/X8STE has five fan headers (Fan1 ~ Fan5). Fans 2~5 are system cooling fans. Fan 1 is used as a CPU fan. These fans are 4-pin fan headers. However, Pins 1-3 of the fan headers are backward compatible with the traditional 3-pin fans. The default setting is **Disabled** which allows the onboard fans to run at full speed. Refer to the table on the right for pin definitions.

Fan Header Pin Definitions	
Pin#	Definition
1	Ground (Black)
2	+12V (Red)
3	Tachometer
4	PWM_Control

 **Note:** Please use all 3-pin fans or all 4-pin fans on a motherboard. Please do not use 3-pin fans and 4-pin fans on the same board.

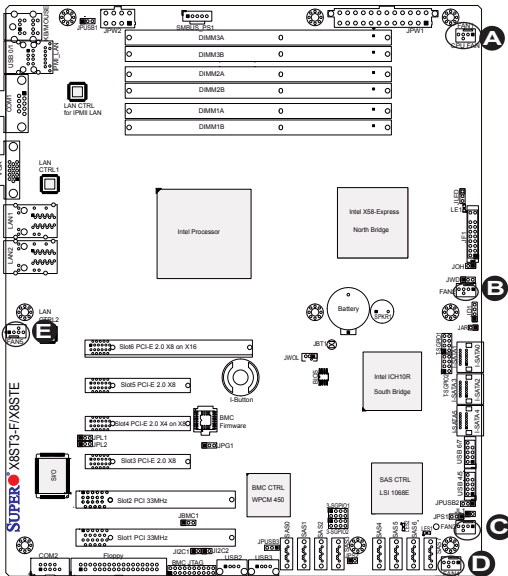

- A. Fan1 (CPU Fan)
- B. Fan2
- C. Fan3
- D. Fan4
- E. Fan5

## Internal Buzzer

The Internal Buzzer (SPKR1) can be used to provide audible indications for various beep codes. See the table on the right for pin definitions. Refer to the layout below for the locations of the Internal Buzzer.

Internal Buzzer Pin Definition		
Pin#	Definitions	
Pin 1	Pos. (+)	Beep In
Pin 2	Neg. (-)	Alarm Speaker

## Speaker

On the JD1 header, Pins 3~4 are used for internal speaker. Close Pins 3~4 with a cap to use the onboard speaker. If you wish to use an external speaker, close Pins 1~4 with a cable. See the table on the right for pin definitions.

Speaker Connector Pin Definitions	
Pin Setting	Definition
Pins 3~4	Internal Speaker
Pins 1~4	External Speaker

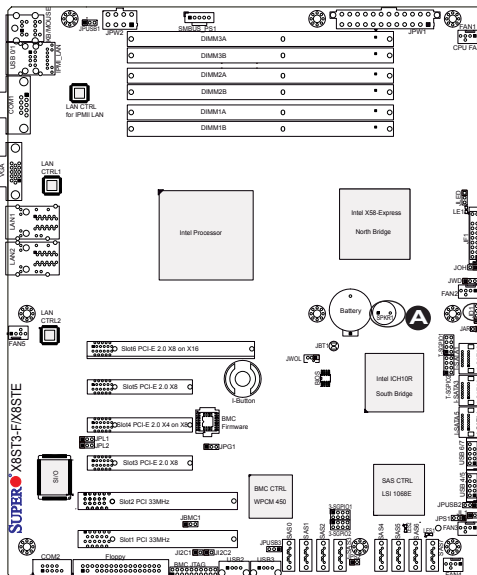

A. Internal Buzzer

B. Speaker

### Overheat/Fan Fail LED

The JOH header is used to connect an LED to provide warnings of chassis overheat. This LED will also blink to indicate a fan failure. Refer to the table on right for pin definitions.

Overheat LED Pin Definitions	
Pin#	Definition
1	5vDC
2	OH Active

OH/Fan Fail LED Pin Definitions	
State	Message
Solid	Overheat
Blinking	Fan Fail

### Chassis Intrusion

A Chassis Intrusion header is located at JL1 on the motherboard. Attach the appropriate cable from the chassis to inform you of a chassis intrusion when the chassis is opened.

Chassis Intrusion Pin Definitions (JL1)	
Pin#	Definition
1	Intrusion Input
2	Ground

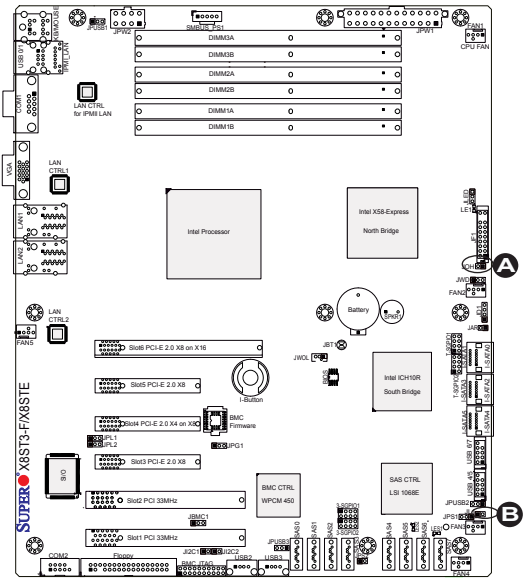

A. Overheat/Fan Fail LED

B. Chassis Intrusion



## Power Supply I<sup>2</sup>C Connector

Power Supply (I<sup>2</sup>C) Connector, located at SMB\_PS1 on the motherboard. This connector monitors the status of the power supply, fan and system temperature. See the table on the right for pin definitions.

PWR Supply I <sup>2</sup> C Pin Definitions	
Pin#	Definition
1	Clock
2	Data
3	PWR Fail
4	Ground

## Onboard Power LED

An onboard Power LED header is located at JLED1. This Power LED header is connected to Front Control Panel located at JF1 to indicate the status of system power. See the table on the right for pin definitions.

Onboard PWR LED Pin Definitions	
Pin#	Definition
1	VCC
2	No Connection
3	Connection to PWR LED in JF1

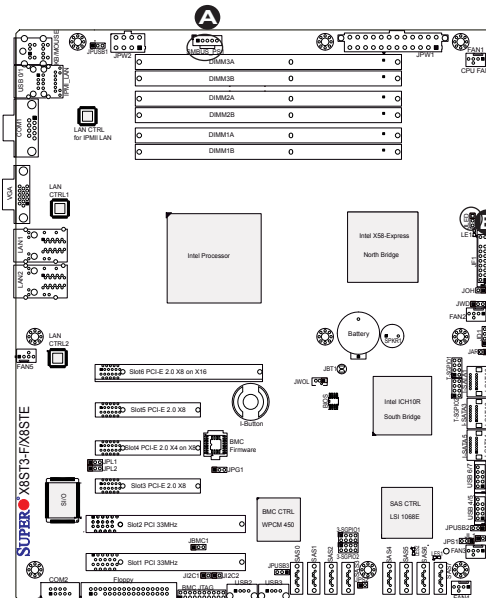

A. PWR SMB

B. PWR LED

**T-SGPIO 0/1 & 3-SGPIO 0/1 Headers**

Two T-SGPIO (Serial-Link General Purpose Input/Output) headers are located next to the I-SATA Port 1 on the motherboard. Additionally, two 3-SGPIO ports are also located next to SAS Port 3 on the X8ST3-F motherboard. These headers are used to communicate with the enclosure management chip in the system. See the table on the right for pin definitions. Refer to the board layout below for the locations of the headers.

Serial_Link-SGPIO Pin Definitions			
Pin#	Definition	Pin	Definition
1	NC	2	NC
3	Ground	4	DATA Out
5	Load	6	Ground
7	Clock	8	NC

NC: No Connections

**Alarm Reset**

If three power supplies are installed and Alarm Reset (JP5) is enabled, the system will notify you when any of the three power modules fail. Connect JP5 to a micro-switch to enable you to turn off the alarm that is activated when a power module fails. See the table on the right for pin definitions.

Alarm Reset Pin Definitions	
Pin Setting	Definition
Pin 1	Ground
Pin 2	+5V

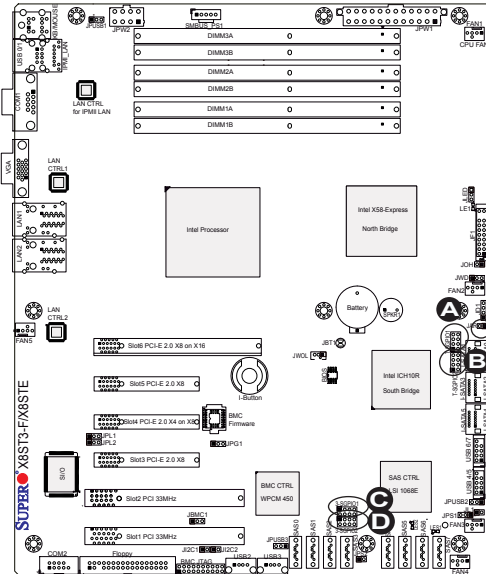

- A. T-SPGIO 0
- B. T-SPGIO 1
- C. 3-SGPIO 0 (X8ST3-F only)
- D. 3-SGPIO 1 (X8ST3-F only)
- E. Alarm Reset

### Wake-On-LAN

The Wake-On-LAN header is located at JWOL on the motherboard. See the table on the right for pin definitions. (You must also have a LAN card with a Wake-On-LAN connector and cable to use this feature.)

Wake-On-LAN Pin Definitions (JWOL)	
Pin#	Definition
1	+5V Standby
2	Ground
3	Wake-up

### I-Button

An onboard I-Button, located next to USB Ports 2~3, is an 1-wire computer chip enclosed in a durable stainless steel can. I-Button stores instructions, provides electronic interface and allows HostRAID to operate with Mega-RAID firmware.



**Note:** RAID 5 is supported when the I-Button (AOC-IButton68) is installed on the motherboard. For more information on the AOC-IButton68, please refer to <http://www.supermicro.com/products/accessories/addon/AOC-Ibutton68.cfm>.

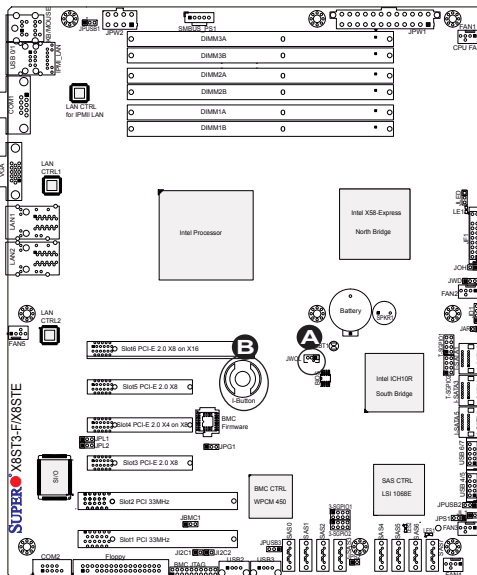

A. WOL

B. I-Button

## 2-7 Jumper Settings

### Explanation of Jumpers

To modify the operation of the motherboard, jumpers can be used to choose between optional settings. Jumpers create shorts between two pins to change the function of the connector. Pin 1 is identified with a square solder pad on the printed circuit board.

**Note:** On two pin jumpers, "Closed" means the jumper is on and "Open" means the jumper is off the pins.

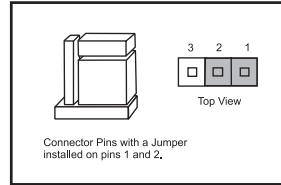
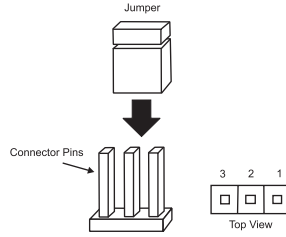

### LAN Port Enable/Disable

JPL1/JPL2 enable or disable LAN Port 1/LAN Port 2 on the motherboard. See the table on the right for jumper settings. The default setting is enabled.

GLAN Enable Jumper Settings	
Pin#	Definition
1-2	Enabled (default)
2-3	Disabled

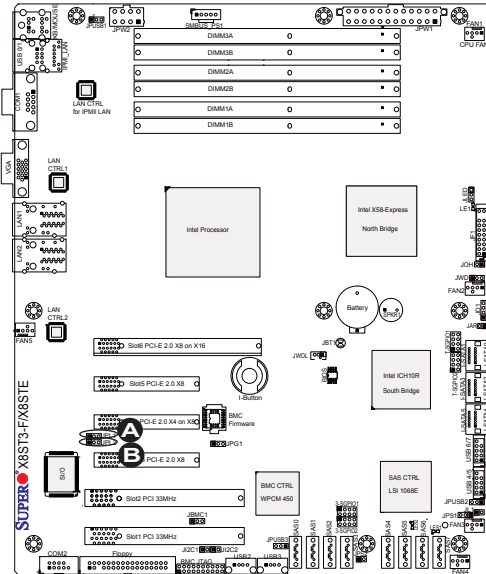

- A. LAN Port 1 Enable
- B. LAN Port 2 Enable



**SMB to PCI-X/PCI-E Slots Speeds**

Use Jumper JI<sup>2</sup>C1 to connect the System Management Bus to the PCI slots, and Jumper JI<sup>2</sup>C2, to the PCI-Exp. slots in order to improve power management for PCI-X and PCI-E slots. The default setting is to close pins 2-3 to disable the function. See the table on the right for jumper settings.

SMBus to PCI-X/PCI-Exp Slots Jumper Settings	
Jumper Setting	Definition
Pins 1-2	Enabled
Pins 2-3 (Default)	Disabled

**(BMC) VGA Enable**

JPG1 allows you to enable or disable the onboard VGA connection supported by the onboard WPCM450 Controller. The default position is on pins 1 and 2 to enable VGA. See the table on the right for jumper settings.

(BMC) VGA Enable/Disable Jumper Settings (JPG1)	
Both Jumpers	Definition
Pins 1-2	Enabled
Pins 2-3	Disabled

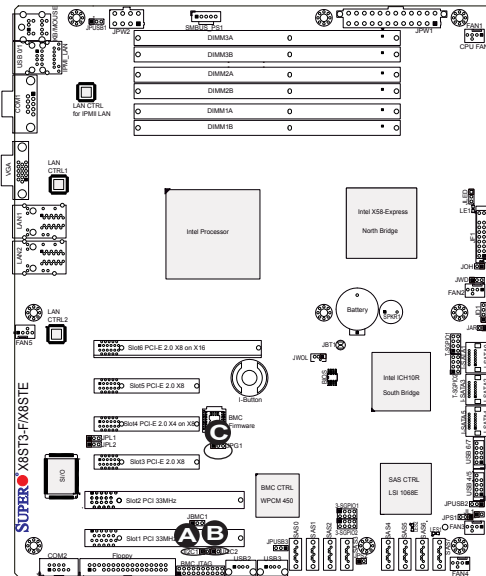

- A. JI<sup>2</sup>C1
- B. JI<sup>2</sup>C2
- C. VGA Enable



**SAS Enable/Disable (X8ST3-F Only)**

JPS1 allows you to enable or disable SAS Connectors. The default position is on pins 1 and 2 to enable SAS. See the table on the right for jumper settings.

SAS Enable/Disable Jumper Settings	
Jumper Settings	Definition
Pins 1-2	Enabled (Default)
Pins 2-3	Disabled

**SAS RAID Mode Select (X8ST3-F Only)**

JPS2 allows you to select the SAS RAID mode. You can use either Software RAID or IT Mode. Close this jumper to use Software RAID (Default). Set this jumper to open to use the IT Mode.

Software RAID Jumper Settings	
Settings	Definition
Close	Software RAID Enabled (Default)
Open	IT Mode Enabled

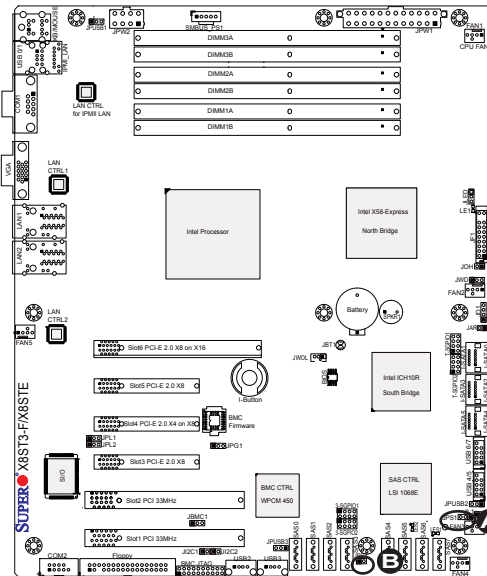

- A. RAID Enable
- B. SAS RAID Mode Select



## BMC IPMI Enable (X7ST3-F only)

JBMC1 allows the user to enable or disable BMC (Baseboard Management Control) Chip and the onboard IPMI connections. This jumper is to be used together with the IPMI settings in the BIOS. If this jumper is set to Enabled, please enable IPMI settings in the BIOS as well and vice versa. The default position is on pins 1 and 2 to Enable BMC. See the table on the right for jumper settings.

BMC IPMI Enable/Disable Jumper Settings	
Settings	Definition
Pins 1-2	Enabled (Default)
Pins 2-3	Disabled

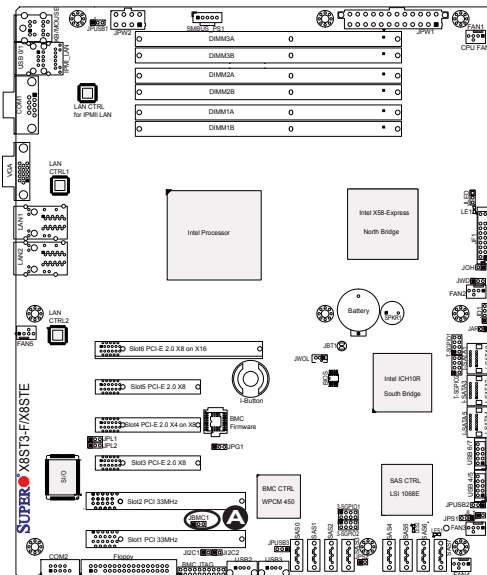

### A. BMC Enable

## 2-8 Onboard Indicators

### LAN 1/LAN 2 LEDs

Two LAN ports (LAN 1/LAN 2) are located on the IO Backplane of the motherboard. Each Ethernet LAN port has two LEDs. The yellow GLAN Activity LED (right, see above right) indicates activity, while the GLAN Link/Speed LED (left) may be green, amber or off to indicate the speed of the connection. See the tables at right for more information.

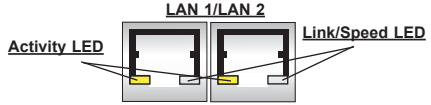

**Rear View** (when facing the rear side of the chassis)

GLAN Link/Speed LED Indicator	
LED Color	Definition
Off	No Connection or 10 Mbps
Green (On)	100 Mbps
Amber (On)	1 Gbps

GLAN Activity LED Indicator	
Color	Definition
Yellow (Flashing)	Connection Active

### IPMI Dedicated LAN LEDs (X8ST3-F Only)

In addition to LAN 1/LAN 2, an IPMI Dedicated LAN is also located on the IO Backplane of the X8ST3-F. The amber LED on the right indicates activity, while the green LED on the left indicates the speed of the connection. See the tables at right for more information.



IPMI LAN Link LED (Left) & Activity LED (Right)		
Color	Status	Definition
Link (Left)	Green: Solid	100 Mbps
Activity (Right)	Amber: Blinking	Active

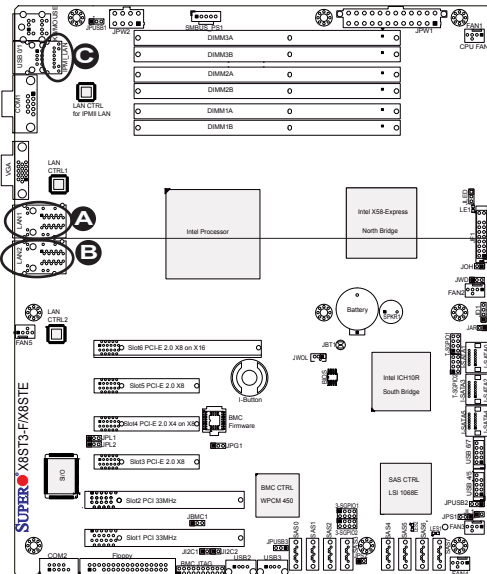

- A. LAN Port 1
- B. LAN Port 2
- C. IPMI LAN

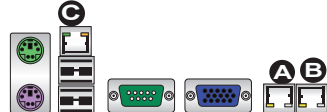

### SAS Activity LED (X8ST3-F Only)

A SAS Activity LED is located at LES1. When LES1 blinks, SAS is active. Refer to the table on the right for details. Also see the layout below for the LED location.

SAS Activity LED Indicator LED Settings	
Blinking: Green	SAS is active

### SAS Heartbeat LED (X8ST3-F Only)

A SAS Heartbeat LED is located at LES2. When LES2 blinks, SAS connectors are ready for use. Refer to the table on the right for details. Also see the layout below for the LED location.

SAS Heartbeat LED Indicator (LES) LED Settings	
Blinking: Yellow	SAS is ready for use

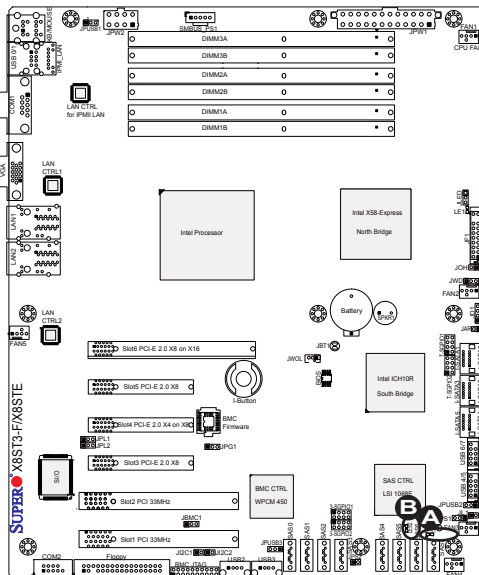

A. SAS Heartbeat

B. SAS Activity

**Onboard Power LED**

An Onboard Power LED is located at LE1 on the motherboard. When LE1 is on, the AC power cable is connected. Make sure to disconnect the power cable before removing or installing any component. See the layout below for the LED location.

Onboard PWR LED Indicator LED Settings	
LED Color	Definition
Off	System Off
On	System on, or System off and PWR Cable Connected

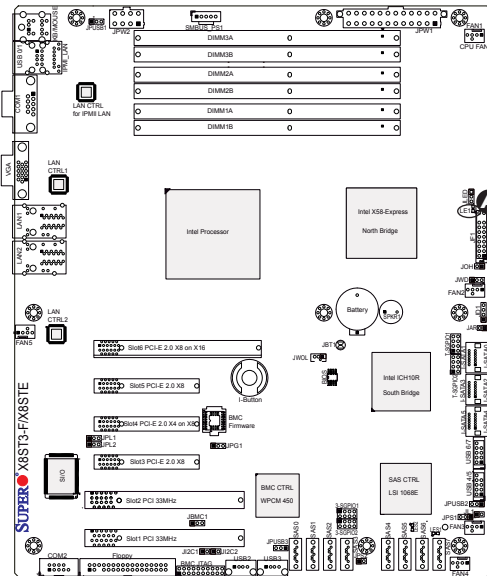

A. Onboard PWR LED



### Floppy Connector

The floppy connector is located near the PCI Slot 1 on the motherboard. See the table on the right for pin definitions.



Note the following when connecting the floppy cable:

- The floppy disk drive cable has seven twisted wires.
- A red mark on a wire typically designates the location of pin 1.
- A single floppy disk drive ribbon cable has 34 wires and two connectors to provide for two floppy disk drives. The connector with twisted wires always connects to drive A, and the connector that does not have twisted wires always connects to drive B.

Floppy Drive Connector Pin Definitions			
Pin#	Definition	Pin #	Definition
1	Ground	2	FDHDIN
3	Ground	4	Reserved
5	Key	6	FDEDIN
7	Ground	8	Index
9	Ground	10	Motor Enable
11	Ground	12	Drive Select B
13	Ground	14	Drive Select B
15	Ground	16	Motor Enable
17	Ground	18	DIR
19	Ground	20	STEP
21	Ground	22	Write Data
23	Ground	24	Write Gate
25	Ground	26	Track 00
27	Ground	28	Write Protect
29	Ground	30	Read Data
31	Ground	32	Side 1 Select
33	Ground	34	Diskette

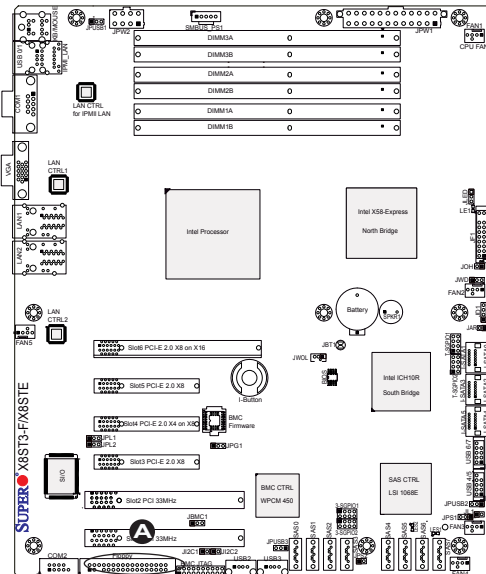

A. Floppy

## Chapter 3

# Troubleshooting

### 3-1 Troubleshooting Procedures

Use the following procedures to troubleshoot your system. If you have followed all of the procedures below and still need assistance, refer to the 'Technical Support Procedures' and/or 'Returning Merchandise for Service' section(s) in this chapter. Always disconnect the AC power cord before adding, changing or installing any hardware components.

#### Before Power On

1. Make sure that the Standby PWR LED (LE1) is not lit. (**Note:** If LE1 is on, the onboard power is on. Be sure to unplug the power cable before installing or removing the components.)
2. Make sure that there are no short circuits between the motherboard and chassis.
3. Disconnect all ribbon/wire cables from the motherboard, including those for the keyboard and mouse. Also, be sure to remove all add-on cards.
4. Install a CPU and heatsink (be sure that it is fully seated) and then connect the chassis speaker and the power LED to the motherboard. Check all jumper settings as well.

#### No Power

1. Make sure that there are no short circuits between the motherboard and chassis.
2. Make sure that all jumpers are set to their default positions.
3. Check if the 115V/230V switch on the power supply is properly set.
4. Turn the power switch on and off to test the system.
5. The battery on your motherboard may be old. Check to make sure that it still supplies ~3VDC. If it does not, replace it with a new one.

#### No Video

1. If the power is on, but you have no video--in this case, you will need to remove all the add-on cards and cables first.

2. Use the speaker to determine if any beep codes exist. (Refer to Appendix A for details on beep codes.)
3. Remove all memory modules and turn on the system. (If the alarm is on, check the specs of memory modules, reset the memory or try a different one.)

## Memory Errors

1. Make sure that the DIMM modules are properly installed and fully seated in the slots.
2. You should be using unbuffered ECC or non-ECC DDR3 (1.5V) 1333/1066/800 MHz memory (recommended by the manufacturer). Also, it is recommended that you use the memory modules of the same type and speed for all DIMMs in the system.
3. Check for bad DIMM modules or slots by swapping modules between slots to see if you can locate the faulty modules.
4. Check the power supply voltage 115V/230V switch.

## Losing the System's Setup Configuration

1. Please be sure to use a high quality power supply. A poor quality power supply may cause the system to lose the CMOS setup information. Refer to Section 1-5 for details on recommended power supplies.
2. The battery on your motherboard may be old. Check to verify that it still supplies ~3VDC. If it does not, replace it with a new one.
3. If the above steps do not fix the Setup Configuration problem, contact your vendor for repairs.

## 3-2 Technical Support Procedures

Before contacting Technical Support, please make sure that you have followed all the steps listed below. Also, Note that as a motherboard manufacturer, Supermicro does not sell directly to end users, so it is best to first check with your distributor or reseller for troubleshooting services. They should know of any possible problem(s) with the specific system configuration that was sold to you.

1. Please go through the 'Troubleshooting Procedures' and 'Frequently Asked Question' (FAQ) sections in this chapter or see the FAQs on our website (<http://www.supermicro.com/support/faqs/>) before contacting Technical Support.
2. BIOS upgrades can be downloaded from our website at (<http://www.supermicro.com>).



[com/support/bios/](http://www.supermicro.com/support/bios/)).



**Note:** Not all BIOS can be flashed. Some cannot be flashed; it depends on the modifications to the boot block code.

3. If you've followed the instructions above to troubleshoot your system, and still cannot resolve the problem, then contact Supermicro's technical support and provide them with the following information:

- Motherboard model and PCB revision number
- BIOS release date/version (this can be seen on the initial display when your system first boots up)
- System configuration

An example of a Technical Support form is on our website at <http://www.supermicro.com/support/contact.cfm>.

4. Distributors: For immediate assistance, please have your account number ready when placing a call to our technical support department. We can be reached by e-mail at [support@supermicro.com](mailto:support@supermicro.com), by phone at: (408) 503-8000, option 2, or by fax at (408)503-8019.

### 3-3 Frequently Asked Questions

**Question:** What type of memory does my motherboard support?

**Answer:** The X8ST3-F/X8STE supports up to 24 GB of **unbuffered** ECC or non-ECC DDR3 (1.5V) 1333/1066/800 MHz, two-way interleaved or non-interleaved SDRAM. See Section 2-4 for details on installing memory.

**Question:** I installed 1333/1066 MHz memory, why doesn't my motherboard (X8SAX, C7X58, X8ST3-F/E or X8STi family) run the memory at 1333/1066 MHz?

Since the memory controller is integrated into the CPU, the memory speed depends on the installed CPUs QPI (QuickPath Interconnect) rating. Please check your CPU specifications. For example, to support 1333 MHz memory, the CPU's QPI should be 6.4GT/S. A lower QPI number means that it will support slower memory. More information may be found at [www.intel.com](http://www.intel.com).

**Question:** How do I update my BIOS?

**Answer:** It is recommended that you **do not** upgrade your BIOS if you are not experiencing any problems with your system. Updated BIOS files are located on our web site at <http://www.supermicro.com/support/bios/>. Please check our

BIOS warning message and the information on how to update your BIOS on our web site. Select your motherboard model and download the BIOS ROM file to your computer. Also, check the current BIOS revision and make sure that it is newer than your BIOS before downloading. You may choose the zip file or the .exe file. If you choose the zipped BIOS file, please unzip the BIOS file onto a bootable device or a USB pen/thumb drive. To flash the BIOS, run the batch file named "ami.bat" with the new BIOS ROM file from your bootable device or USB pen/thumb drive. Use the following format:

```
F:\> ami.bat BIOS-ROM-filename.xxx <Enter>
```



**Notes:** Always use the file named "ami.bat" to update the BIOS and insert a space between "ami.bat" and the filename. The BIOS-ROM-filename will bear the motherboard name (i.e., X8ST3) and build version as the extension. For example, "X8ST30.115".

When completed, your system will automatically reboot. If you choose the .exe file, please run the .exe file under Windows to create the BIOS flash floppy disk. Insert the floppy disk into the system you wish to flash the BIOS. Then, boot the system to the floppy disk. The BIOS utility will automatically flash the BIOS without any prompts. Please note that this process may take a few minutes to complete. Do not be concerned if the screen is paused for a few minutes.



**Warning:** Do not shut down or reset the system while updating the BIOS to prevent possible system boot failure!

When the BIOS flashing screen is completed, the system will reboot and will show "Press F1 or F2". At this point, you will need to load the BIOS defaults. Press <F1> to go to the BIOS setup screen, and press <F9> to load the default settings. Next, press <F10> to save and exit. The system will then reboot.



**Note:** The SPI BIOS chip installed on this motherboard is not removable. To repair or replace a damaged BIOS chip, please send your motherboard to RMA at Supermicro for service.

**Question: I think my BIOS is corrupted. How can I recover my BIOS?**

**Answer:** Please see Appendix D, BIOS Recovery for detailed instructions.

**Question: What's on the CD that came with my motherboard?**

**Answer:** The supplied compact disc has quite a few drivers and programs that will greatly enhance your system. We recommend that you review the CD and install the applications you need. Applications on the CD include chipset drivers for Windows, security and audio drivers.

**Question: Is the PCI-Ex16 slot on X8 boards reserved for graphic cards only?**

**Answer:** No, the PCI-Ex16 slot is not only for graphic cards. It may be used for PCI-E storage, LAN, and other peripherals.

**Question: Does X8 series motherboards come with a screw type CPU heat sink bracket?**

**Answer:** No, it does not come with a bracket for a screw-type heat sink. Customers have to purchase it separately. Please contact RMA for information, ask for part number BKT\_0023L.

**Question: Under the Microsoft Windows environment, how do I configure my power button to shut-off instantly or wait 4 seconds before powering down?**

**Answer:** Enter the BIOS Setup -> Advanced -> Boot Feature -> Power Button Function. Select "Instant Off" if you want the system to power down instantly when the power button is pressed, or select "4 Second Override" to require the power button to be pressed continuously for 4 seconds before shutting off.

### **3-4 Returning Merchandise for Service**

A receipt or copy of your invoice marked with the date of purchase is required before any warranty service will be rendered. You can obtain service by calling your vendor for a Returned Merchandise Authorization (RMA) number. When returning to the manufacturer, the RMA number should be prominently displayed on the outside of the shipping carton, and mailed prepaid or hand-carried. Shipping and handling charges will be applied for all orders that must be mailed when service is complete.

This warranty only covers normal consumer use and does not cover damages incurred in shipping or from failure due to the alteration, misuse, abuse or improper maintenance of products.

During the warranty period, contact your distributor first for any product problems.

## Notes

## Chapter 4

# BIOS

### 4-1 Introduction

This chapter describes the AMI BIOS Setup Utility for the X8ST3-F/X8STE. The AMI ROM BIOS is stored in a Flash EEPROM and can be easily updated. This chapter describes the basic navigation of the AMI BIOS Setup Utility setup screens.

#### Starting BIOS Setup Utility

To enter the AMI BIOS Setup Utility screens, press the <Delete> key while the system is booting up.



**Note:** In most cases, the <Delete> key is used to invoke the AMI BIOS setup screen. There are a few cases when other keys are used, such as <F1>, <F2>, etc.

Each main BIOS menu option is described in this manual. The Main BIOS setup menu screen has two main frames. The left frame displays all the options that can be configured. Grayed-out options cannot be configured. Options in blue can be configured by the user. The right frame displays the key legend. Above the key legend is an area reserved for a text message. When an option is selected in the left frame, it is highlighted in white. Often a text message will accompany it. (**Note:** the AMI BIOS has default text messages built in. Supermicro retains the option to include, omit, or change any of these text messages.)

The AMI BIOS Setup Utility uses a key-based navigation system called "hot keys". Most of the AMI BIOS setup utility "hot keys" can be used at any time during the setup navigation process. These keys include <F1>, <F10>, <Enter>, <ESC>, arrow keys, etc.



**Note:** Options printed in **Bold** are default settings.

#### How To Change the Configuration Data

The configuration data that determines the system parameters may be changed by entering the AMI BIOS Setup utility. This Setup utility can be accessed by pressing <Del> at the appropriate time during system boot.

## How to Start the Setup Utility

Normally, the only visible Power-On Self-Test (POST) routine is the memory test. As the memory is being tested, press the <Delete> key to enter the main menu of the AMI BIOS Setup Utility. From the main menu, you can access the other setup screens. An AMI BIOS identification string is displayed at the left bottom corner of the screen, below the copyright message.



**Warning!** Do not upgrade the BIOS unless your system has a BIOS-related issue. Flashing the wrong BIOS can cause irreparable damage to the system. In no event shall Supermicro be liable for direct, indirect, special, incidental, or consequential damages arising from a BIOS update. If you have to update the BIOS, do not shut down or reset the system while the BIOS is updating. This is to avoid possible boot failure.

## 4-2 Main Setup

When you first enter the AMI BIOS Setup Utility, you will enter the Main setup screen. You can always return to the Main setup screen by selecting the Main tab on the top of the screen. The Main BIOS Setup screen is shown below.

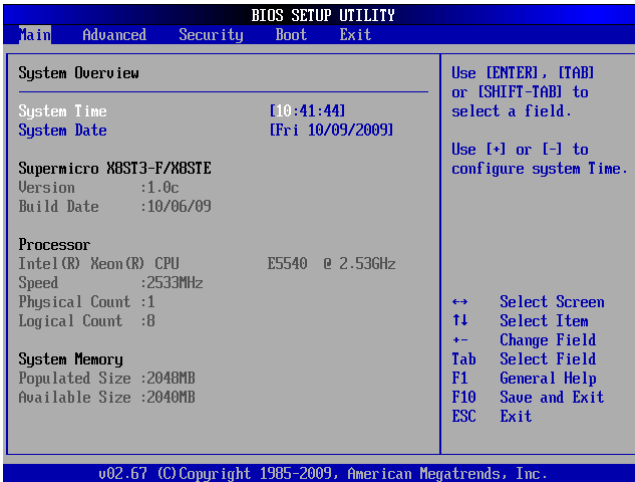

**System Overview:** The following BIOS information will be displayed:

### **System Time/System Date**

Use this option to change the system time and date. Highlight *System Time* or *System Date* using the arrow keys. Enter new values through the keyboard. Press the <Tab> key or the arrow keys to move between fields. The date must be entered in Day MM/DD/YY format. The time is entered in HH:MM:SS format. (**Note:** The time is in the 24-hour format. For example, 5:30 P.M. appears as 17:30:00.)

Supermicro X8ST3-F/X8STE

Version

Build Date

### **Processor**

The AMI BIOS will automatically display the status of processor as shown below:

Type of Processor

Speed

Physical Count

Logical Count

### **System Memory**

This displays the size of memory available in the system:

Populated Size

Available Size

## 4-3 Advanced Setup Configurations

Use the arrow keys to select Boot Setup and hit <Enter> to access the submenu items:

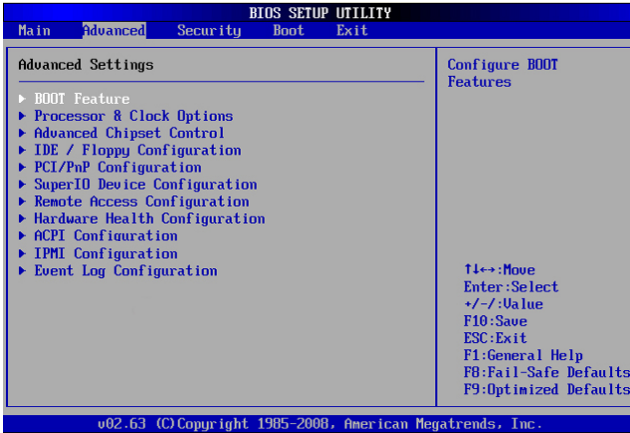

### ►BOOT Feature

#### Quick Boot

If Enabled, this option will skip certain tests during POST to reduce the time needed for system boot. The options are **Enabled** and Disabled.

#### Quiet Boot

This option allows the bootup screen options to be modified between POST messages or the OEM logo. Select Disabled to display the POST messages. Select Enabled to display the OEM logo instead of the normal POST messages. The options are **Enabled** and Disabled.

#### AddOn ROM Display Mode

This sets the display mode for Option ROM. The options are **Force BIOS** and Keep Current.

#### Bootup Num-Lock

This feature selects the Power-on state for Numlock key. The options are Off and **On**.

#### PS/2 Mouse Support

This feature enables support for the PS/2 mouse. The options are Disabled, Enabled and **Auto**.



**Wait For 'F1' If Error**

This forces the system to wait until the 'F1' key is pressed if an error occurs. The options are Disabled and **Enabled**.

**Hit 'Del' Message Display**

This feature displays "Press DEL to run Setup" during POST. The options are **Enabled** and Disabled.

**Watch Dog Function**

If enabled, the Watch Dog Timer will allow the system to reboot when it is inactive for more than 5 minutes. The options are Enabled and **Disabled**.

**Power Button Function**

This setting allows you to decide if the power button will instantly turn the system off, or wait 4 seconds to turn off while the button is depressed. The options are 4 Seconds Override and **Instant Off**.

**Restore on AC Power Loss**

Use this feature to set the power state after a power outage. Select Power-Off for the system power to remain off after a power loss. Select Power-On for the system power to be turned on after a power loss. Select Last State to allow the system to resume its last state before a power loss. The options are Power-On, Power-Off and **Last State**.

**Interrupt 19 Capture**

Interrupt 19 is the software interrupt that handles the boot disk function. When this item is set to Enabled, the ROM BIOS of the host adaptors will "capture" Interrupt 19 at boot and allow the drives that are attached to these host adaptors to function as bootable disks. If this item is set to Disabled, the ROM BIOS of the host adaptors will not capture Interrupt 19, and the drives attached to these adaptors will not function as bootable devices. The options are **Enabled** and Disabled.

**► Processor & Clock Options**

**Warning:** Take Caution when changing the Advanced settings. An incorrect value, a very high DRAM frequency or incorrect DRAM timing may cause system to become unstable. When this occurs, revert to the default setting.

**CPU Ratio**

This feature allows the user to use the CPU clock multiplier to multiply CPU speed in order to enhance performance. Select Manual to Manually set the multiplier set-

ting. Select Auto for the BIOS to automatically select the CPU multiplier setting for your system. The options are **Auto** and Manual.

#### **Clock Spread Spectrum**

Select Enable to use the feature of Clock Spectrum, which will allow the BIOS to monitor and attempt to reduce the level of Electromagnetic Interference caused by the components whenever needed. Select Disabled to enhance system stability. The options are **Disabled** and Enabled.

#### **Hardware Prefetcher (Available when supported by the CPU)**

If set to Enabled, the hardware pre fetcher will pre fetch streams of data and instructions from the main memory to the L2 cache in the forward or backward manner to improve CPU performance. The options are Disabled and **Enabled**.

#### **Adjacent Cache Line Prefetch (Available when supported by the CPU)**

The CPU fetches the cache line for 64 bytes if this option is set to Disabled. The CPU fetches both cache lines for 128 bytes as comprised if **Enabled**.

#### **MPS and ACPI MADT Ordering**

Choose the method of ordering for the Multiple APIC Description Table (MADT). Select Modern Ordering for Microsoft Windows XP or later, Select Legacy Ordering for Microsoft Windows 2000 or earlier. The options are **Modern Ordering** and Legacy Ordering.

#### **Intel® Virtualization Technology (Available when supported by the CPU)**

Select Enabled to use the feature of Virtualization Technology to allow one platform to run multiple operating systems and applications in independent partitions, creating multiple "virtual" systems in one physical computer. The options are **Enabled** and Disabled. **Note:** If there is any change to this setting, you will need to power off and restart the system for the change to take effect. Please refer to Intel's web site for detailed information.

#### **Execute-Disable Bit Capability (Available when supported by the OS and the CPU)**

Set to Enabled to enable the Execute Disable Bit which will allow the processor to designate areas in the system memory where an application code can execute and where it cannot, thus preventing a worm or a virus from flooding illegal codes to overwhelm the processor or damage the system during an attack. The default is **Enabled**. (Refer to Intel and Microsoft Web Sites for more information.)

**Intel AES-NI (When supported by the CPU)**

Intel® AES instructions are a new set of instructions available beginning with the the all new 2010 Intel® Core™ processor family based on the 32nm Intel® microarchitecture. These instructions enable fast and secure data encryption and decryption, using the Advanced Encryption Standard (AES). The options are **Disabled** and **Enabled**.

**Simultaneous Multi-Threading (Available when supported by the CPU)**

Set to **Enabled** to use the Hyper-Threading Technology, which will result in increased CPU performance. The options are **Disabled** and **Enabled**.

**Active Processor Cores**

Set to **Enabled** to use a processor's Second Core and beyond. (Please refer to Intel's web site for more information.) The options are **All**, **1** and **2**.

**Intel® EIST Technology**

EIST (Enhanced Intel SpeedStep Technology) allows the system to automatically adjust processor voltage and core frequency in an effort to reduce power consumption and heat dissipation. **Please refer to Intel's web site for detailed information.** The options are **Disable** (Disable GV3), and **Enable** (**Enable GV3**).

**Intel® Turbo Boost (Available if Intel® EIST technology is Enabled)**

This feature allows processor cores to run faster than marked frequency in specific conditions. The options are **Disabled** and **Enabled**.

**C1E Support**

Select **Enabled** to use the "Enhanced Halt State" feature. C1E significantly reduces the CPU's power consumption by reducing the CPU's clock cycle and voltage during a "Halt State." The options are **Disabled** and **Enabled**.

**Intel C-STATE Tech**

If enabled, C-State is set by the system automatically to either C2, C3 or C4 state. The options are **Disabled** and **Enabled**.

**C-State package limit setting**

If set to **Auto**, the AMI BIOS will automatically set the limit on the C-State package register. The options are **Auto**, **C1**, **C3**, **C6** and **C7**.

**C1 Auto Demotion**

When enabled, the CPU will conditionally demote C3, C6 or C7 requests to C1 based on un-core auto-demote information. The options are **Disabled** and **Enabled**.

### C3 Auto Demotion

When enabled, the CPU will conditionally demote C6 or C7 requests to C3 based on un-core auto-demote information. The options are Disabled and **Enabled**.

### ACPI T State

This feature Enables the ACPI throttling support for the processor to save power. The options are **Disabled** and Enabled.

### DCA Technology

This feature accelerates the performance of TOE devices. **Note:** A TOE device is a specialized, dedicated processor that is installed on an add-on card or a network card to handle some or all packet processing of this add-on card. For this motherboard, the TOE device is built inside the ESB 2 South Bridge chip. This feature is supported only by some types of processors. The options are **Enabled** and Disabled.

### DCA Prefetch Delay

A DCA Prefetch is used with TOE components to prefetch data in order to shorten execution cycles and maximize data processing efficiency. Prefetching too frequently can saturate the cache directory and delay necessary cache accesses. This feature reduces or increases the frequency the system prefetches data. The options are [8], [16], **[32]**, [40], [48], [56], [64], [72], [80], [88], [96], [104], [112], [120]

## ►Advanced Chipset Control

The items included in the Advanced Settings submenu are listed below.

## ►QPI and IMC Configuration

QuickPath Interconnect (QPI) is the connection between the CPU and the motherboard's I/O hub. Use this feature to modify speed and power management settings.

### QPI Links Speed

Use this feature to select QPI data transfer speed. The options are Slow-mode, and **Full Speed**.

### QPI Frequency

Use this option to set the QPI frequency. The options are **Auto**, 4.800 GT, 5.866 GT, and 6.400 GT.

### QPI L0s and L1

QuickPath Interconnect (QPI) offers three power states called L0, L0s and L1:

L0 is a normal operational state where data and control packets can be transmitted and received. All power management states are entered from this state.

L0s is intended as a power saving state. It allows a link to quickly enter and recover from a power saving state without going through recovery.

L1 is a power saving state that allows an additional power saving over L0s, but with additional resume (wake-up) latency.

Select Enabled to activate QPI power saving (L0s and L1 are automatically selected by the motherboard), select Disabled for normal operational state without any power-saving function. The options are Disabled and **Enabled**.

### **Memory Frequency**

Use this option to force the system memory to run at a different frequency than the default frequency. The available options are **Auto**, Force DDR-800, Force DDR-1066, and Force DDR-1333.

### **Memory Mode**

The options are **Independent**, Channel Mirror, Lockstep and Sparing.

Independent - All DIMMs are available to the operating system.

Channel Mirror - The motherboard maintains two identical copies of all data in memory for redundancy.

Lockstep - The motherboard uses two areas of memory to run the same set of operations in parallel.

Sparing - Memory sparing occurs when on-demand inactive memory is automatically activated by the system to temporarily replace failed memory until a service action can be performed (supported only on 2010 Intel® Core™ processor family based on the 32nm Intel® microarchitecture).

### **Demand Scrubbing**

Demand Scrubbing is a process that allows the CPU to correct correctable memory errors found on a memory module. When the CPU or I/O issues a demand-read command, and the read data from memory turns out to be a correctable error, the error is corrected and sent to the requestor (the original source). Memory is updated as well. Select Enabled to use Demand Scrubbing for ECC memory correction. The options are Enabled and **Disabled**.

### **Patrol Scrubbing**

Patrol Scrubbing is a process that allows the CPU to correct correctable memory errors detected on a memory module and send the correction to the requestor (the original source). When this item is set to Enabled, the North Bridge will read and write back one cache line every 16K cycles, if there is no delay caused by internal processing. By using this method, roughly 64 GB of memory behind the North Bridge will be scrubbed every day. The options are Enabled and **Disabled**.

### Throttling - Closed Loop

Throttling improves reliability and reduces power in the processor by automatic voltage control during processor idle states. Available options are Disabled and **Enabled**.

### Intel VT-d

Select Enabled to enable Intel's Virtualization Technology support for Direct I/O VT-d by reporting the I/O device assignments to VMM through the DMAR ACPI Tables. This feature offers fully-protected I/O resource-sharing across the Intel platforms, providing the user with greater reliability, security and availability in networking and data-sharing. The settings are Enabled and **Disabled**.

### SR-IOV Support

Enable this item to support Single Root I/O Virtualization and Sharing (SR-IOV). The options are **Disabled** and Enabled.

### Intel I/OAT

The Intel I/OAT (I/O Acceleration Technology) significantly reduces CPU overhead by leveraging CPU architectural improvements, freeing resources for more other tasks. The options are Disabled and **Enabled**.

### Active State Power Management

Select Enabled to start Active-State Power Management for signal transactions between L0 and L1 Links on the PCI Express Bus. This maximizes power-saving and transaction speed. The options are Enabled and **Disabled**.

### Route Port 80h Cycles to

This feature allows the user to decide which bus to send debug information to. The options are Disabled, **PCI** and LPC.

### USB Functions

This feature allows the user to decide the number of onboard USB ports to be enabled. The Options are: Disabled, 2 USB ports, 4 USB ports, 6 USB ports, 8 USB ports, 10 USB Ports and **12 USB Ports**.

### USB 2.0 Controller

Select Enabled to activate the onboard USB 2.0 controller. The options are **Enabled** and Disabled.

---

## Legacy USB Support

Select Enabled to use Legacy USB devices. If this item is set to Auto, Legacy USB support will be automatically enabled if a legacy USB device is installed on the motherboard, and vice versa. The settings are Disabled, Enabled and **Auto**.

## ► IDE / Floppy Configuration

When this submenu is selected, the AMI BIOS automatically detects the presence of the IDE Devices and displays the following items:

### Floppy A

This feature allows the user to select the type of floppy drive connected to the system. The options are Disabled, 360KB 5 1/4", 1.2MB 5 1/4", 720KB 3 1/2", **1.44MB 3 1/2"** and 2.88MB 3 1/2".

### SATA#1 Configuration

If Compatible is selected, it sets SATA#1 to legacy compatibility mode, while selecting Enhanced sets SATA#1 to native SATA mode. The options are Disabled, Compatible, **Enhanced**.

#### Configure SATA#1 as

This feature allows the user to select the drive type for SATA#1. The options are **IDE**, RAID and AHCI.

#### ICH RAID CodeBase (Available if RAID is selected above)

Select Intel to enable the Intel SATA Host RAID Utility. Select Adaptec to use the Adaptec Host RAID Utility. The options are **Intel** and Adaptec.

### SATA#2 Configuration (Available if IDE is enabled under "Configure SATA#1 as" above)

Selecting Enhanced will set SATA#2 to native SATA mode. The options are Disabled, **Enhanced**

### IDE Detect Timeout (sec)

Use this feature to set the time-out value for the BIOS to detect the ATA, ATAPI devices installed in the system. The options are 0 (sec), 5, 10, 15, 20, 25, 30, and **35**.

### Primary IDE Master/Slave, Secondary IDE Master/Slave, Third IDE Master, and Fourth IDE Master

These settings allow the user to set the parameters of Primary IDE Master/Slave, Secondary IDE Master/Slave, Third and Fourth IDE Master slots. Hit <Enter> to

activate the following submenu screen for detailed options of these items. Set the correct configurations accordingly. The items included in the submenu are:

### **Type**

Select the type of device connected to the system. The options are Not Installed, **Auto**, CD/DVD and ARMD.

### **LBA/Large Mode**

LBA (Logical Block Addressing) is a method of addressing data on a disk drive. In the LBA mode, the maximum drive capacity is 137 GB. For drive capacities over 137 GB, your system must be equipped with a 48-bit LBA mode addressing. If not, contact your manufacturer or install an ATA/133 IDE controller card that supports 48-bit LBA mode. The options are Disabled and **Auto**.

### **Block (Multi-Sector Transfer)**

Block Mode boosts the IDE drive performance by increasing the amount of data transferred. Only 512 bytes of data can be transferred per interrupt if Block Mode is not used. Block Mode allows transfers of up to 64 KB per interrupt. Select Disabled to allow data to be transferred from and to the device one sector at a time. Select Auto to allow data transfer from and to the device occur multiple sectors at a time if the device supports it. The options are **Auto** and Disabled.

### **PIO Mode**

The IDE PIO (Programmable I/O) Mode programs timing cycles between the IDE drive and the programmable IDE controller. As the PIO mode increases, the cycle time decreases. The options are **Auto**, 0, 1, 2, 3, and 4.

Select Auto to allow the AMI BIOS to automatically detect the PIO mode. Use this value if the IDE disk drive support cannot be determined.

Select 0 to allow the AMI BIOS to use PIO mode 0. It has a data transfer rate of 3.3 MB/s.

Select 1 to allow the AMI BIOS to use PIO mode 1. It has a data transfer rate of 5.2 MB/s.

Select 2 to allow the AMI BIOS to use PIO mode 2. It has a data transfer rate of 8.3 MB/s.

Select 3 to allow the AMI BIOS to use PIO mode 3. It has a data transfer rate of 11.1 MB/s.

Select 4 to allow the AMI BIOS to use PIO mode 4. It has a data transfer bandwidth of 32-Bits. Select Enabled to enable 32-Bit data transfer.



**DMA Mode**

Select Auto to allow the BIOS to automatically detect IDE DMA mode when the IDE disk drive support cannot be determined.

Select SWDMA0 to allow the BIOS to use Single Word DMA mode 0. It has a data transfer rate of 2.1 MB/s.

Select SWDMA1 to allow the BIOS to use Single Word DMA mode 1. It has a data transfer rate of 4.2 MB/s.

Select SWDMA2 to allow the BIOS to use Single Word DMA mode 2. It has a data transfer rate of 8.3 MB/s.

Select MWDMA0 to allow the BIOS to use Multi Word DMA mode 0. It has a data transfer rate of 4.2 MB/s.

Select MWDMA1 to allow the BIOS to use Multi Word DMA mode 1. It has a data transfer rate of 13.3 MB/s.

Select MWDMA2 to allow the BIOS to use Multi-Word DMA mode 2. It has a data transfer rate of 16.6 MB/s.

Select UDMA0 to allow the BIOS to use Ultra DMA mode 0. It has a data transfer rate of 16.6 MB/s. It has the same transfer rate as PIO mode 4 and Multi Word DMA mode 2.

Select UDMA1 to allow the BIOS to use Ultra DMA mode 1. It has a data transfer rate of 25 MB/s.

Select UDMA2 to allow the BIOS to use Ultra DMA mode 2. It has a data transfer rate of 33.3 MB/s.

Select UDMA3 to allow the BIOS to use Ultra DMA mode 3. It has a data transfer rate of 44.4 MB/s.

Select UDMA4 to allow the BIOS to use Ultra DMA mode 4 . It has a data transfer rate of 66.7 MB/s.

Select UDMA5 to allow the BIOS to use Ultra DMA mode 5 . It has a data transfer rate of 100.0 MB/s.

Select UDMA6 to allow the BIOS to use Ultra DMA mode 6 . It has a data transfer rate of 133 MB/s.

The options are **Auto**, SWDMA<sub>n</sub>, MWDMA<sub>n</sub>, and UDMA<sub>n</sub>.

**S.M.A.R.T.**

Self-Monitoring Analysis and Reporting Technology (SMART) can help predict impending drive failures. Select Auto to allow the AMI BIOS to automatically detect hard disk drive support. Select Disabled to prevent the AMI BIOS from using

the S.M.A.R.T. Select Enabled to allow the AMI BIOS to use the S.M.A.R.T. to support hard drive disk. The options are Disabled, Enabled, and **Auto**.

### **32-Bit Data Transfer**

Select Enable to enable the function of 32-bit IDE data transfer. The options are **Enabled** and Disabled.

## **► PCI/PnP Configuration**

This feature allows the user to set the PCI/PnP configurations for the following items:

### **Clear NVRAM**

This feature clears the NVRAM during system boot. The options are **No** and Yes.

### **Plug & Play OS**

Selecting Yes allows the OS to configure Plug & Play devices. (This is not required for system boot if your system has an OS that supports Plug & Play.) Select **No** to allow the AMI BIOS to configure all devices in the system.

### **PCI Latency Timer**

This feature sets the latency Timer of each PCI device installed on a PCI bus. Select 64 to set the PCI latency to 64 PCI clock cycles. The options are 32, **64**, 96, 128, 160, 192, 224 and 248.

### **PCI IDE Bus Master**

When enabled, the BIOS uses PCI bus mastering for reading/writing to IDE drives. The options are Disabled and **Enabled**.

### **PCIe I/O Performance**

This feature selects the setting for the IOH PCIe maximum payload size. The options are **128B** and 256B.

### **ROM Scan Ordering**

This item determines what kind of option ROM activates over another. The options are **Onboard First** and Add-on First.

### **Slot 1 PCI 33MHz, Slot 2 PCI 33MHz, Slot 3 PCIe x8, Slot 4 PCIe x4 on x8, Slot 5 PCIe x8, Slot 6 PCIe x8 on x16**

Use this feature to enable or disable a PCI-E or a PCI slot. The options are Disabled and **Enabled**.

---

**Load Onboard LAN1 Option ROM/Load Onboard LAN2 Option ROM**

This feature is to enable LAN OPROM for PXE. This is to boot computers using a network interface. The options are **Disabled** and **Enabled**.

**Load SAS Option ROM (X8ST3-F Only)**

This feature is to load the Serial Attached SCSI (SAS) option ROM, if available. The options are **Disabled** and **Enabled**.

**Boot Graphics Adapter Priority**

Use this feature to select the graphics controller to be used as the primary boot device. The options are **Other**, **Onboard VGA** and **Slot 6**. Select **Slot 6** if a graphics controller is installed in the CPU-controlled Slot 6 slot.

**► Super IO Device Configuration****Serial Port1 Address/ Serial Port2 Address**

This option specifies the base I/O port address and the Interrupt Request address of Serial Port 1 and Serial Port 2. Select **Disabled** to prevent the serial port from accessing any system resources. When this option is set to **Disabled**, the serial port physically becomes unavailable. Select **3F8/IRQ4** to allow the serial port to use 3F8 as its I/O port address and IRQ 4 for the interrupt address. The options for Serial Port1 are **Disabled**, **3F8/IRQ4**, **2E8/IRQ3**. The options for Serial Port2 are **Disabled**, **2F8/IRQ3**, and **2E8/IRQ3**.

**Onboard Floppy Controller**

Select **Enabled** to enable the onboard Floppy Controller. The options are **Enabled** and **Disabled**.

**► Remote Access Configuration****Remote Access**

This allows the user to enable the Remote Access feature. The options are **Disabled** and **Enabled**.

If Remote Access is set to **Enabled**, the following items will display:

**Serial Port Number**

This feature allows the user to decide which serial port to be used for Console Redirection. The options are **COM 1 (Base Address 3F8h, IRQ 4)**, **COM 2 (Base Address 2F8h, IRQ 3)** and **COM 3 (Base Address 3E8h, IRQ 5)**. An ad-

ditional option, Onboard IPMI is featured on the X8ST3-F motherboard only, and becomes the default.

### Serial Port Mode

This feature allows the user to set the serial port mode for Console Redirection. The options are **115200 8, n 1**; 57600 8, n, 1; 38400 8, n, 1; 19200 8, n, 1; and 9600 8, n, 1.

### Flow Control

This feature allows the user to set the flow control for Console Redirection. The options are **None**, Hardware, and Software.

### Redirection After BIOS POST

Select Disabled to turn off Console Redirection after Power-On Self-Test (POST). Select Always to keep Console Redirection active all the time after POST. (Note: This setting may not be supported by some operating systems.) Select Boot Loader to keep Console Redirection active during POST and Boot Loader. The options are Disabled, Boot Loader, and **Always**.

### Terminal Type

This feature allows the user to select the target terminal type for Console Redirection. The options are ANSI, **VT100**, and VT-UTF8.

### VT-UTF8 Combo Key Support

A terminal keyboard definition that provides a way to send commands from a remote console. Available options are **Enabled** and Disabled.

### Sredir Memory Display Delay

This feature defines the length of time in seconds to display memory information. The options are **No Delay**, Delay 1 Sec, Delay 2 Sec, and Delay 4 Sec.

## ►Hardware Health Configuration

This feature allows the user to monitor Hardware Health of the system and review the status of each item when displayed.

### CPU Overheat Alarm

This option allows the user to select the CPU Overheat Alarm setting which determines when the CPU OH alarm will be activated to provide warning of possible CPU overheat.



**Warning:** Any temperature that exceeds the CPU threshold temperature predefined by the CPU manufacturer may result in CPU overheating or system instability. When the CPU temperature reaches this predefined threshold, the CPU and system cooling fans will run at full speed.

The options are:

- The Early Alarm: Select this setting if you want the CPU overheating alarm (including the LED and the buzzer) to be triggered as soon as the CPU temperature reaches the CPU overheating threshold as predefined by the CPU manufacturer.
- **The Default Alarm:** Select this setting if you want the CPU overheating alarm (including the LED and the buzzer) to be triggered when the CPU temperature reaches about 5°C above the threshold temperature as predefined by the CPU manufacturer to give the CPU and system fans additional time needed for CPU and system cooling. In both the alarms above, please take immediate action as shown below. (See the notes on P. 4-18 for more information.)

### CPU Temperature/System Temperature

This feature displays current temperature readings for the CPU and the System.

The following items will be displayed for your reference only:

#### CPU Temperature

The CPU Temperature feature will display the CPU temperature status as detected by the BIOS:

**Low** – This level is considered as the 'normal' operating state. The CPU temperature is well below the CPU 'Temperature Tolerance'. The motherboard fans and CPU will run normally as configured in the BIOS (Fan Speed Control).

User intervention: No action required.

**Medium** – The processor is running warmer. This is a 'precautionary' level and generally means that there may be factors contributing to this condition, but the CPU is still within its normal operating state and below the CPU 'Temperature Tolerance'. The motherboard fans and CPU will run normally as configured in the BIOS. The fans may adjust to a faster speed depending on the Fan Speed Control settings.

User intervention: No action is required. However, consider checking the CPU fans and the chassis ventilation for blockage.

**High** – The processor is running hot. This is a 'caution' level since the CPU's 'Temperature Tolerance' has been reached (or has been exceeded) and may activate an overheating alarm:

The Default Alarm – the Overheat LED and system buzzer will activate if the High condition continues for some time after it is reached. The CPU fan will run at full

speed to bring the CPU temperature down. If the CPU temperature still increases even with the CPU fan running at full speed, the system buzzer will activate and the Overheat LED will turn on.

The Early Alarm – the Overheat LED and system buzzer will be activated exactly when the High level is reached. The CPU fan will run at full speed to bring the CPU temperature down.

Note: In both the alarms above, please take immediate action as shown below. See CPU Overheat Alarm to modify the above alarm settings.

User intervention: If the system buzzer and Overheat LED has activated, take action immediately by checking the system fans, chassis ventilation and room temperature to correct any problems. Note: the system may shut down if it continues for a long period to prevent damage to the CPU.



**Notes:** The CPU thermal technology that reports absolute temperatures (Celsius/Fahrenheit) has been upgraded to a more advanced feature by Intel in its newer processors. The basic concept is that each CPU is embedded by a unique temperature information that the motherboard can read. This 'Temperature Threshold' or 'Temperature Tolerance' has been assigned at the factory and is the baseline by which the motherboard takes action during different CPU temperature conditions (i.e., by increasing CPU Fan speed, triggering the Overheat Alarm, etc). Since CPUs can have different 'Temperature Tolerances', the installed CPU can now send its 'Temperature Tolerance' to the motherboard resulting in better CPU thermal management.

Supermicro has leveraged this feature by assigning a temperature status to certain thermal conditions in the processor (Low, Medium and High). This makes it easier for the user to understand the CPU's temperature status, rather than by just simply seeing a temperature reading (i.e., 25°C).

The information provided above is for your reference only. For more information on thermal management, please refer to Intel's Web site at [www.Intel.com](http://www.Intel.com).

### **System Temperature**

This feature displays the absolute system temperature (i.e., 34°C).

### **Fan1 ~ Fan 5 Reading**

This feature displays the fan speed readings from fan interfaces Fan1 through Fan5.

### **Fan Speed Control Modes**

This feature allows the user to decide how the system controls the speeds of the onboard fans. The CPU temperature and the fan speed are correlative. When the CPU on-die temperature increases, the fan speed will also increase for effective

system cooling. Select Full Speed to allow the onboard fans to run at full speed (of 100% Pulse Width Modulation Duty Cycle) for maximum cooling. The Full Speed setting is recommended for special system configuration or debugging. Select Performance for the onboard fans to run at 70% of the Initial PWM Cycle for better system cooling. The Performance setting is recommended for high-power-consuming and high-density systems. Select Balanced for the onboard fans to run at 50% of the Initial PWM Cycle in order to balance the needs between system cooling and power saving. The Balanced setting is recommended for regular systems with normal hardware configurations. Select Energy Saving for the onboard fans to run at 30% of the Initial PWM Cycle for best power efficiency and maximum quietness. The Options are: Full Speed/FS (@100% of PWM Cycle), Performance/PF (@70% of PWM Cycle), **Balanced/BL** (@50% of PWM Cycle), and Energy Saving/ES (@30% of PWM Cycle).

### **Voltage Reading**

This feature displays the current voltage detected of the various components in the system:

Vcore, VDIMM, 5V, 12V, -12V, 3.3Vcc, 3.3VSB, VBAT, Vtt

### **►ACPI Configuration**

Use this feature to configure Advanced Configuration and Power Interface (ACPI) power management settings for your system.

### **High Performance Event Timer**

Select Enabled to activate the High Performance Event Timer (HPET) that produces periodic interrupts at a much higher frequency than a Real-time Clock (RTC) does in synchronizing multimedia streams, providing smooth playback and reducing the dependency on other timestamp calculation devices, such as an x86 RDTSC Instruction embedded in the CPU. The High Performance Event Timer is used to replace the 8254 Programmable Interval Timer. The options are **Enabled** and Disabled.

### **ACPI Aware O/S**

Enable ACPI support if it is supported by the OS to control ACPI through the Operating System. Otherwise, disable this feature. The options are **Yes** and No.

### **AMI OEMB Table**

This enables the OEMB table support. The options are **Enabled** and Disabled.

### **ACPI APIC Support**

Select Enabled to include the ACPI APIC Table Pointer in the RSDT (Root System Description Table) pointer list. The options are **Enabled** and Disabled.

---

### **APIC ACPI SCI IRQ**

When this item is set to Enabled, APIC ACPI SCI IRQ is supported by the system. The options are Enabled and **Disabled**.

### **Headless Mode**

This feature is used to enable system to function without a keyboard, monitor or mouse attached. The options are Enabled and **Disabled**.

### **ACPI Version Features**

The options are ACPI v1.0, **ACPI v2.0** and ACPI v3.0. Please refer to ACPI's website for further explanation: <http://www.acpi.info/>

## **► IPMI Configuration (X8ST3-F Only)**

Intelligent Platform Management Interface (IPMI) is a set of common interfaces that IT administrators can use to monitor system health and to manage the system as a whole. For more information on the IPMI specifications, please visit Intel's website at [www.intel.com](http://www.intel.com).

### **IPMI Firmware Revision**

This item displays the current IPMI firmware revision.

### **Status of BMC**

Baseboard Management Controller (BMC) manages the interface between system management software and platform hardware. This is an informational feature which returns the status code of the BMC micro controller.

### **View BMC System Event Log**

This feature is used to view any BMC events. It shows the total number of entries and will allow the viewing of each event by scrolling down on an Entry Number and pressing Enter.

### **Clear BMC System Event Log**

This feature is used to clear the System Event Log. Caution: Any cleared information is unrecoverable. Make absolutely sure you no longer need any data stored in the log before clearing the BMC Event Log.

### **Set LAN Configuration**

Set this feature to configure the IPMI LAN adapter with a network address.

**Channel Number** - Enter the channel number for the SET LAN Config command. This is initially set to **[1]**. Press "+" or "-" on your keyboard to change the Channel Number.



**Channel Number Status** - This feature returns the channel status for the Channel Number selected above: "Channel Number is OK" or "Wrong Channel Number".

**IP Address Source** - This feature selects whether the IP address, Subnet Mask and Gateway Address are automatically assigned by the network's DHCP server (Dynamic Host and Configuration Protocol) or manually entered by the user (Static). If Static is selected, the IP Address, Subnet Mask and Gateway Address must be manually entered below. If DHCP is selected, the next three items will be configured automatically and will be grayed out. The options are Static and **DHCP**.

**IP Address** - Enter the IP address for this machine. This should be in decimal and in dotted quad form (i.e., 192.168.10.253). The value of each three-digit number separated by dots should not exceed 255.

**Subnet Mask** - Subnet masks tell the network which subnet this machine belongs to. The value of each three-digit number separated by dots should not exceed 255 (i.e., 255.255.255.0).

**Gateway Address** - Enter the Gateway address this machine will use (i.e., 192.168.10.1).

**MAC Address** - The BIOS will automatically enter the MAC address (also known as Hardware Address) of this machine, however it may be over-ridden. MAC addresses are 6 two-digit hexadecimal numbers (Base 16, 0 ~ 9, A, B, C, D, E, F) separated by dots. (i.e., 00.30.48.D0.D4.60)

### **BMC Watch Dog Timer Action**

Allows the BMC to reset or power down the system if the operating system hangs or crashes. The options are **Disabled**, Reset System, Power Down, Power Cycle.

#### **BMC WatchDog TimeOut [Min:Sec]**

This option appears if BMC Watch Dog Timer Action (above) is enabled. This is a timed delay in minutes or seconds, before a system power down or reset after an operating system failure is detected. The options are **[5 Min]**, [1 Min], [30 Sec], and [10 Sec].

## **►Event Log Configuration**

### **View Event Log**

Use this option to view the System Event Log.

### **Mark all events as read**

This option marks all events as read. The options are OK and Cancel.

**Clear event log**

This option clears the Event Log memory of all messages. The options are OK and **Cancel**.

**PCIe Error Log**

Use this option to enable logging of errors encountered in the system's PCIe bus. The options are Yes and **No**.

**Memory ECC Error Log**

Use this option to enable logging of errors encountered in the system's memory. The options are **Yes** and No.

## 4-4 Security Settings

The AMI BIOS provides a Supervisor and a User password. If you use both passwords, the Supervisor password must be set first.

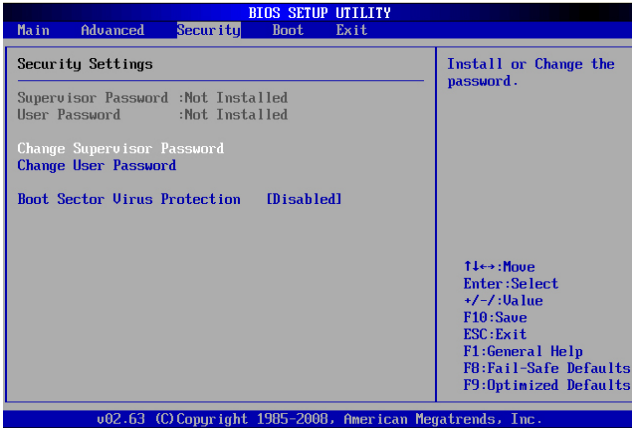

### Supervisor Password

This item indicates if a supervisor password has been entered for the system. Clear means such a password has not been used and Set means a supervisor password has been entered for the system.

### User Password:

This item indicates if a user password has been entered for the system. Clear means such a password has not been used and Set means a user password has been entered for the system.

### Change Supervisor Password

Select this feature and press <Enter> to access the submenu, and then type in a new Supervisor Password.

### User Access Level (Available when Supervisor Password is set as above)

Available options are **Full Access**: grants full User read and write access to the Setup Utility, **View Only**: allows access to the Setup Utility but the fields cannot be changed, **Limited**: allows only limited fields to be changed such as Date and Time, **No Access**: prevents User access to the Setup Utility.

### Change User Password

Select this feature and press <Enter> to access the submenu , and then type in a new User Password.

**Clear User Password (Available only if User Password has been set)**

**Password Check**

Available options are **Setup** and **Always**.

**Boot Sector Virus Protection**

When Enabled, the AMI BOIS displays a warning when any program (or virus) issues a Disk Format command or attempts to write to the boot sector of the hard disk drive. The options are **Enabled** and **Disabled**.

**4-5 Boot Configuration**

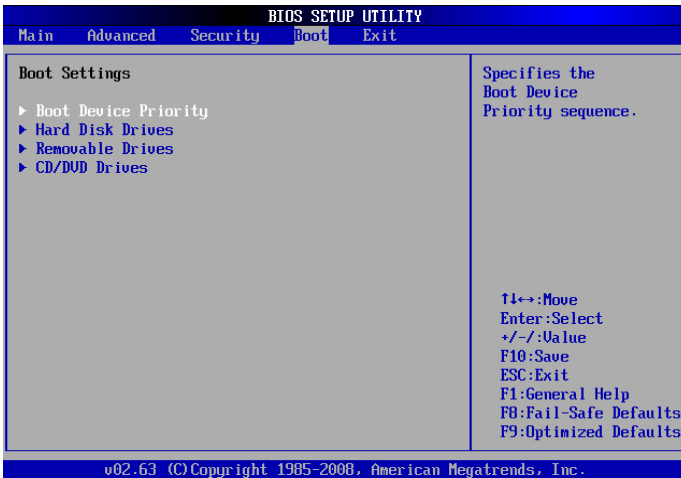

Use this feature to configure Boot Settings:

**► Boot Device Priority**

This feature allows the user to specify the sequence of priority for the Boot Device. The settings are 1st boot device, 2nd boot device, 3rd boot device, 4th boot device, 5th boot device and Disabled.

- 1st Boot Device - 1st Floppy Drive
- 2nd Boot Device - [USB: XXXXXXXXX]
- 3rd Boot Device - [SATA: XXXXXXXXX]
- 4th Boot Device - [Network: XXXXXXXXX]
- 5th Boot Device - [Network: XXXXXXXXX]

## ► Hard Disk Drives

This feature allows the user to specify the boot sequence from all available hard disk drives. The settings are Disabled and a list of all hard disk drives that have been detected (i.e., 1st Drive, 2nd Drive, 3rd Drive, etc).

## ► Removable Drives

This feature allows the user to specify the boot sequence from available Removable Drives. The settings are 1st boot device, 2nd boot device, and Disabled.

- 1st Drive
- 2nd Drive - [USB: XXXXXXXXX]

## ► CD/DVD Drives

This feature allows the user to specify the boot sequence from available CD/DVD Drives (i.e., 1st Drive, 2nd Drive, etc).

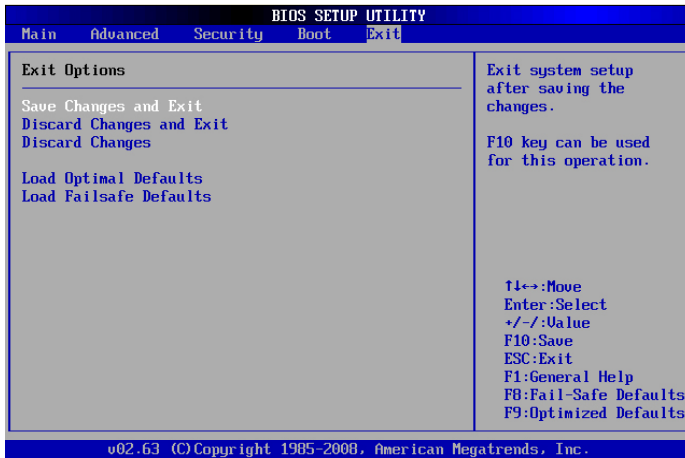

## 4-6 Exit Options

Select the Exit tab from the AMI BIOS Setup Utility screen to enter the Exit BIOS Setup screen.

### Save Changes and Exit

When you have completed the system configuration changes, select this option to leave the BIOS Setup Utility and reboot the computer, so the new system con-

figuration parameters can take effect. Select Save Changes and Exit from the Exit menu and press <Enter>.

### **Discard Changes and Exit**

Select this option to quit the BIOS Setup without making any permanent changes to the system configuration, and reboot the computer. Select Discard Changes and Exit from the Exit menu and press <Enter>.

### **Discard Changes**

Select this option and press <Enter> to discard all the changes and return to the AMI BIOS Utility Program.

### **Load Optimal Defaults**

To set this feature, select Load Optimal Defaults from the Exit menu and press <Enter>. Then, select OK to allow the AMI BIOS to automatically load Optimal Defaults to the BIOS Settings. The Optimal settings are designed for maximum system performance, but may not work best for all computer applications.

### **Load Fail-Safe Defaults**

To set this feature, select Load Fail-Safe Defaults from the Exit menu and press <Enter>. The Fail-Safe settings are designed for maximum system stability, but not for maximum performance.

## Appendix A

### POST Error Beep Codes

This section lists POST (Power On Self Test) error beep codes for the AMI BIOS. POST error beep codes are divided into two categories: recoverable and terminal. This section lists Beep Codes for recoverable POST errors.

#### Recoverable POST Error Beep Codes

When a recoverable type of error occurs during POST, BIOS will display a POST code that describes the problem. BIOS may also issue one of the following beep codes:

- 1 long and two short beeps - video configuration error
- 1 repetitive long beep - no memory detected
- 1 continuous beep with the front panel Overheat LED on - system overheat
- 8 beeps - Memory error.

## Notes



## Appendix B

### Installing the Windows OS

After all hardware components have been installed, you must first configure Intel South Bridge RAID Settings before you install the Windows OS and other software drivers. To configure RAID settings, please refer to RAID Configuration User Guides posted on our website at [www.supermicro.com/support/manuals](http://www.supermicro.com/support/manuals).

#### B-1 Installing the Windows OS for Systems with RAID Functions

1. Insert Microsoft's Windows XP/2003 Setup CD in the CD Drive, and the system will start booting up from CD.
  2. Press the <F6> key when the message-" Press F6 if you need to install a third party SCSI or RAID driver" displays.
  3. When the Windows XP/2003 Setup screen appears, press "S" to specify additional device(s).
  4. Insert the driver diskette- "ITE RAID XP/2003 Driver into Drive A: and press the <ENTER> key.
  5. When the Windows XP/2003 Setup screen appears, press "S" to specify additional device(s).
  6. Insert the driver diskette-"Intel AA RAID XP/2003 Driver for ICH10R" into Drive A: and press the <Enter> key.
  7. Choose the Intel(R) ICH10R SATA RAID Controller from the list indicated in the XP/2003 Setup Screen, and press the <Enter> key.
  8. Press the <Enter> key to continue the installation process. (If you need to specify any additional devices to be installed, do it at this time.) Once all devices are specified, press the <Enter> key to continue with the installation.
  9. From the Windows XP/2003 Setup screen, press the <Enter> key. The XP/2003 Setup will automatically load all device files and then, continue the Windows XP/2003 installation.
  10. After the Windows XP/2003 OS Installation is completed, the system will automatically reboot.
-

## B-2 Installing the Windows OS for Systems without RAID Functions

1. Insert Microsoft's Windows XP/2003 Setup CD in the CD Driver, and the system will start booting up from CD.
2. Press the <F6> key when the message-" Press F6 if you need to install a third party SCSI or RAID driver" displays.
3. When the Windows XP/2003 Setup screen appears, press "S" to specify additional device(s).
4. Insert the driver diskette-"ITE RAID XP/2003 Driver for IDE" into Drive A: and press the <Enter> key.
5. Press the <Enter> key to proceed with the installation process. (If you need to specify any additional devices to be installed, do it at this time.) Once all devices are specified, press the <Enter> key to continue with the installation.
6. From the Windows XP/2003 Setup screen, press the <Enter> key. The XP/2003 Setup will automatically load all device files and then continue with the Windows XP/2003 installation.
7. After the Windows XP/2003 OS Installation is completed, the system will automatically reboot.
8. Insert the Supermicro Setup CD that came with your motherboard into the CD Drive during system boot, and the main screen shown on Page C-1 in Appendix C will display. Follow the instructions given in Appendix C to complete software installation.

## Appendix C

### Software Installation Instructions

#### C-1 Installing Drivers

After you've installed the Windows Operating System, a screen as shown below will appear. You are ready to install software programs and drivers that have not yet been installed. To install these software programs and drivers, click the icons to the right of these items. (**Note:** To install the Windows Operating System, please refer to the instructions posted on our website at <http://www.supermicro.com/support/manuals/>.)

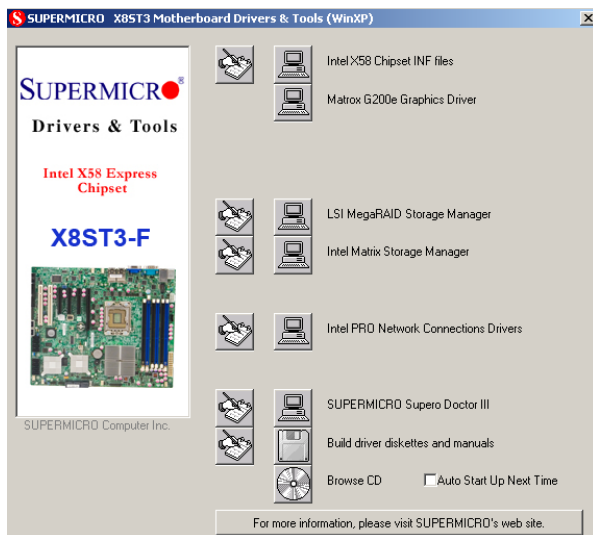

#### Driver/Tool Installation Display Screen



**Note 1.** Click the icons showing a hand writing on the paper to view the readme files for each item. Click on a computer icon to the right of an item to install this item (from top to the bottom), one at a time. After installing each item, you must reboot the system before proceeding with the next item on the list. The bottom icon with a CD on it allows you to view the entire contents of the CD.

**Note 2.** When making a storage driver diskette by booting into a Driver CD, please set the SATA Configuration to "Compatible Mode" and configure SATA as IDE in the BIOS Setup. After making the driver diskette, be sure to change the SATA settings back to your original settings.

## C-2 Configuring SuperDoctor<sup>®</sup> III

The SuperDoctor III program is a Web-based management tool that supports remote management capability. It includes Remote and Local Management tools. The local management is called the SD III Client. The SuperDoctor III program included on the CDROM that came with your motherboard allows you to monitor the environment and operations of your system. SuperDoctor III displays crucial system information such as CPU temperature, system voltages and fan status. See the Figure below for a display of the SuperDoctor III interface.



**Note:** 1 The default user name and password are ADMIN.

**Note 2:** In the Windows OS environment, the SuperDoctor III settings take precedence over the BIOS settings. When first installed, SuperDoctor III adopts the temperature threshold settings previously set in BIOS. Any subsequent changes to these thresholds must be made within SuperDoctor, since the SD III settings override the BIOS settings. For the Windows OS to adopt the BIOS temperature threshold settings, please change the SDIII settings to be the same as those set in BIOS.

SuperDoctor III Interface Display Screen-I (Health Information)

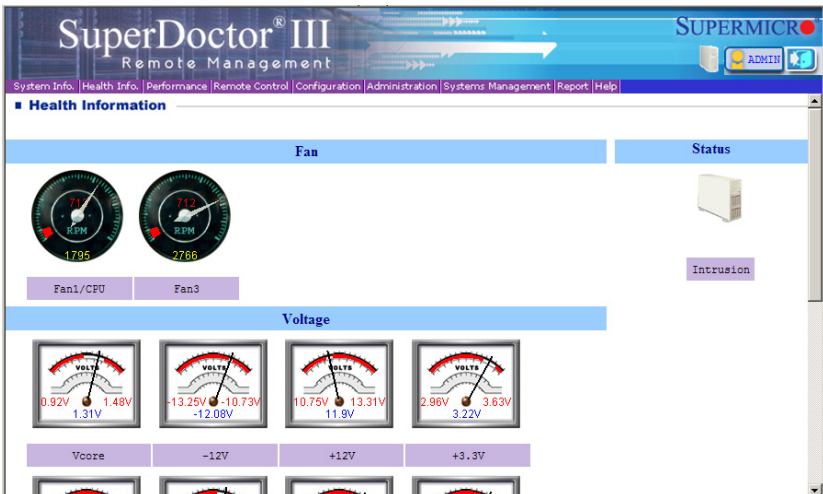

## SuperDoctor III Interface Display Screen-II (Remote Control)



**Graceful power control (cancelable)**

Supero Doctor III allows a user to inform the OS to reboot or shut down the system within 30 seconds. On the system console, a pop-up window will appear with a message telling the local user to save his working files. Before the system reboots or shuts down, it's allowed to cancel the action either locally or remotely.

**Power control (noncancelable)**

Supero Doctor III allows a user to inform the OS to reboot or shut down the system right away. The system will reboot or shut down without any warning messages. It's not allowed to cancel the action.



**Note:** The SuperDoctor III software and manual can be downloaded from our Website at: <http://www.supermicro.com/products/accessories/software/SuperDoctorIII.cfm>. For Linux, we will still recommend that you use Supero Doctor II, which can also be downloaded from the link above.

## Notes

---

---

## Appendix D - BIOS Recovery

The recovery procedure described in this section is to be used only when advised by your Supermicro Technical Support representative, or in cases of emergencies where the system no longer can boot due to a corrupted BIOS. DO NOT re-program (re-flash) the BIOS if your system is running properly.

### D-1 Recovery Process from a USB Device/Drive (Recommended Method)

If the BIOS file is corrupted and the system is not able to boot up, this feature will allow you to recover the BIOS image using a USB-attached device. A USB Flash Drive or a USB CD/DVD ROM/RW drive may be used for this purpose. Please note that a USB Hard Disk drive is NOT supported at this time. Below is a two-part procedure to recover the BIOS:

#### Part 1: Boot Sector Recovery Process

1. Using a different system, download and copy the correct BIOS binary image into a USB flash device or a writable CD/DVD disc's Root "" Directory. Rename the downloaded file to "super.rom", so the recovery process can recognize and read the BIOS binary file.
2. Insert the USB device that contains the new BIOS binary image ("super.rom") and power the system down.
3. While powering on the system, press and hold <Ctrl> and <Home> simultaneously on your keyboard until the USB device's LED indicator comes on. This will take a few seconds or up to one minute.
4. Once the USB device's LED is on, release the <Ctrl> and <Home> keys. The system may generate beep codes to indicate that the BIOS ROM firmware is being reprogrammed. The screen will also display a message as shown below. DO NOT INTERRUPT THIS PROCESS!

```
Starting FLASH Recovery.  
NVRAM data will be destroyed.  
CMOS data will be destroyed.  
.....  
.....  
Ending FLASH Recovery.  
FLASH Update completed successfully.  
Rebooting...
```

5. When the Boot Sector Recovery Process is complete, the system will reboot automatically and you will see a checksum error on your screen.

## Part 2 - BIOS Reprogramming (Re-Flashing)

After completing the Boot Sector Recovery Process, you will need to reprogram ("re-flash") the proper BIOS binary file again into the BIOS ROM in order to have the correct BIOS file loaded by the system. For details on how to flash/re-flash a BIOS, please check our website for "Update your BIOS", or see the section 3-3 (FAQ) of this manual. **DO NOT INTERRUPT THIS PROCESS!**

When completed, the system will reboot automatically, and you will see a checksum error again.

Press "F1" to go to setup. Press "F9" to load the defaults and then press "F10" to save and exit.

## D-2 Recovery Process from an IDE/SATA ATAPI Disc Drive

This process is identical to the Boot Sector Recovery Process from a USB Device/Drive (as above), except that the BIOS image file ("super.rom") is loaded from an IDE/ATAPI CD/DVD-ROM/RW disc drive that is attached to the system. Note that loading from an IDE/SATA hard disk drive is NOT supported.

1. Using a different system, download and copy the correct BIOS binary image into a writable CD/DVD disc's Root "\\" Directory. Rename the downloaded file to "super.rom", so the recovery process can recognize and read the BIOS binary file.



**Note:** Record/Burn the CD/DVD-R/RW disc using the ISO 9600 standard format. Refer to your CD/DVD mastering application documentation for instructions on how to do this.

2. Insert the newly-created disc into the IDE/SATA ATAPI CD/DVD ROM/RW drive of the system that has the corrupted BIOS and power the system down.
3. Follow the step-by-step instructions under Part 1 - Recovery Process from a USB Device/Drive (above) starting from Step 3 and continue on to Part 2 - BIOS Reprogramming (Re-Flashing).

If your system still does not boot up after performing the above procedure, then there may be other issues with your motherboard. Please contact your customer service representative.



(Disclaimer Continued)

The products sold by Supermicro are not intended for and will not be used in life support systems, medical equipment, nuclear facilities or systems, aircraft, aircraft devices, aircraft/emergency communication devices or other critical systems whose failure to perform be reasonably expected to result in significant injury or loss of life or catastrophic property damage. Accordingly, Supermicro disclaims any and all liability, and should buyer use or sell such products for use in such ultra-hazardous applications, it does so entirely at its own risk. Furthermore, buyer agrees to fully indemnify, defend and hold Supermicro harmless for and against any and all claims, demands, actions, litigation, and proceedings of any kind arising out of or related to such ultra-hazardous use or sale.