

# RITCHEY User Manual

## Handlebars, bar ends, aero bars, stems, grips and bar tape

Important information about use, care, maintenance and installation

### Contents

Introduction	1
Before Your First Ride – Intended Use	1
Before Every Ride	2
Special Characteristics of Carbon	2
Cleaning and Care	3
Maintenance	3
General Notes on Installation	3
RITCHEY Liquid Torque	4
RITCHEY Torquey	4
RITCHEY Torque Wrench	5
Installing Aheadset®-Stems	5
Adjusting the Aheadset®-Headset	6
Installing the Handlebars	7
Mountain Bike – Adjusting Controls and Levers	8
Road Bike – Adjusting the Handlebars	8
Installing Bar Ends	9
Adjusting the Handlebar Height	10
Aheadset®-Stems	10
Readjusting the Aheadset® by Using Spacers	10
Adjustable Stems	11
C260 Stems	12
Stem to Bar Installation	12
Stem Tightening	13
Installing and Adjusting Aero Bars	14
WCS Carbon Hammerhead TT Base Bar	14
WCS Carbon Interval Base Bar	15
Pro Base Bar	15
Installing the Arm Rests WCS “Wedge” Carbon-Alloy	16
Installing the Arm Rests WCS “Sliver” Carbon-Alloy	17
Grips and Bar Tape	18
Installing the Grips	18
Wrapping the Bar Tape	18
Warranty Terms	19
A Note on Wear	19
Manufacturer’s Guarantee	20

### Notes on This User Manual

Pay particular attention to the following symbols:

 This symbol means that your life or health may be in danger unless you comply with provided instructions or carry out prescribed measures.

 This symbol warns you about actions that could lead to damage of property or the environment.

 This symbol indicates there is special information on how to handle the product and may refer you to a specific passage in this manual requiring your special attention.

The possible consequences described above are not repeated every time one of the symbols appears!

## Introduction

Congratulations, when buying a RITCHEY part, you made a superb choice. RITCHEY develops, tests and manufactures our products with dedication to uphold the highest standards of quality. Like all high-quality sports equipment, RITCHEY components require careful installation in order to function properly and to provide long-term dependability. We recommend that you ask a qualified mechanic at your authorized RITCHEY dealer for help with installation and use RITCHEY components together whenever possible in order to achieve optimum performance and durability. Our precise tolerances are intended to ensure component compatibility, and are carefully monitored during production and quality control so that installation will be easy and trouble-free.

This manual contains important notes about use, care, maintenance and installation.

Please read this manual carefully, beginning with the general information, followed by the chapter referring to the component you purchased, or you intend to use. Doing so will ensure smooth installation and trouble-free use of the product.

Keep this user manual for your records and future reference. If you sell or lend your component or bike to someone, share this manual with the new user.

With RITCHEY components, as with all lightweight bicycle products, special care and attention need to be paid to proper installation and intended use. Materials used by RITCHEY are extremely strong and durable, with very low weight. However, sometimes they can break, rather than bend, in the event of an accident. Internal damage to the component may not show up obviously or with visible signs of damage. In the event of undue stress of any kind, e.g. as a result of a crash, the components need to be inspected by a qualified mechanic to ensure the product is safe to use. Therefore, consult your RITCHEY dealer after any such occurrence.

## Before Your First Ride – Intended Use

RITCHEY handlebars, bar ends and stems (a) are designed for road racing, triathlon, cyclocross, trekking and mountain bikes and their typical use. They are, however, not suitable for freeriding, dual slalom, downhill riding, jumps or the like. If you use your bike for this type of cycling you should opt for the special RITCHEY SC (“Severe Condition”) components.

 Never make any changes to handlebars, bar ends and stems. Do not file or drill holes in components, especially in carbon components, as it will compromise their structural integrity and void your warranty.

RITCHEY stems are designed to be only used with threadless headsets, also referred to as Aheadset®-headsets! Attempting to use a RITCHEY stem in combination with a threaded fork steerer can lead to sudden failure, resulting in a crash with unforeseeable consequences.

Make sure when performing any adjusting that the brake levers are always within easy reach. Keep in mind that the brake levers are not within easy reach when you ride with your hands on the bar ends or aero bars. The SuperLogic Evolution and Logic II road handlebars are not suitable for clip-on aero bars!

We recommend that you always use RITCHEY components together in order to achieve optimum performance and component durability.

If you intend to combine RITCHEY components (e.g. handlebars or stems) with components from other manufacturers, make sure they are compatible, i.e. that all dimensions are identical with the specifications given in this manual.

 RITCHEY handlebars and stems are designed for an overall load of 110 kilos (242 lbs) including rider and baggage, e.g. rucksack.

 After a crash, accident or other major impact, have your RITCHEY handlebars, stems and bar ends or aero bars, checked and, if necessary, replaced by your RITCHEY dealer for your own safety.

 If your handlebars, stem and bar ends or aero bars, if mounted, produce any creaking or cracking noises or show any external damage, such as notches, cracks, dents, discoloration etc., do not use your bike any longer. Ask your RITCHEY dealer to check these components thoroughly and to replace them, if necessary.

 In case you have any questions, please contact your RITCHEY dealer.

## Before Every Ride

1. Verify the tight fit of the stem on the fork steerer and of the handlebars in the stem.
2. Are the quick-release levers or nuts of the front and rear wheel properly closed? For more information see the respective chapters of your general bike user manual.

 Improperly closed quick-releases or thru axles can cause the wheels to come loose. This can lead to a serious accident!

 Read the user manual of your bike manufacturer before you set off!

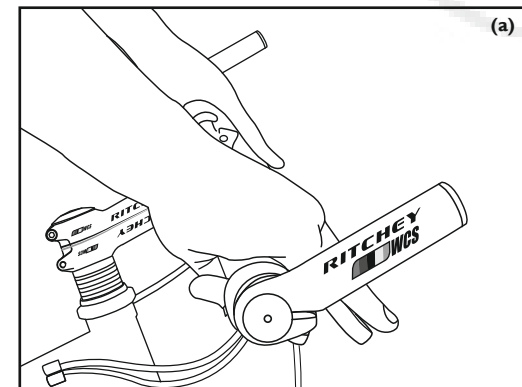

## Special Characteristics of Carbon

All RITCHEY products made of carbon fiber-reinforced plastic, also referred to as carbon or abbreviated CFR, require special care and attention.

Carbon is an extremely strong material that allows the production of components combining high compression resistance with low weight. Please note that carbon, unlike metals, shows no visible deformation after undue stress even though some of its fibers may be damaged. This makes it very dangerous to continue using a carbon component after an impact or undue stress, as it may fail without previous warning, thereby causing an accident with unforeseeable consequences.

If your RITCHEY carbon component sustained this kind of impact or undue stress, we strongly recommend that you take your complete bike to your RITCHEY dealer for inspection. They will check the damaged bike and, if necessary, replace the defective component. In case there are any unanswered questions or doubts, the RITCHEY dealer can contact the RITCHEY after-sales department or one of the RITCHEY distributors directly.

 For safety reasons components made of carbon must never be repaired! Replace a damaged component immediately. Make sure that any damage components will not be re-used. It should be destroyed to ensure that re-use is impossible.

Components made of carbon must under no circumstances be exposed to excessive heat. Therefore, never have a carbon component enamelled or powder-coated. The temperatures required for doing so could destroy it. Do not leave carbon fiber components near a source of heat or in a car or trunk during hot or sunny weather.

Components made of carbon have like all lightweight components only a limited service life. Therefore, to be on the safe side it is recommended that you replace handlebars, stems and headsets depending on use at regular intervals (e.g. every three years), even if they were not involved in an accident or similar incident.

Make sure the clamping areas are absolutely free of grease and other lubricants, especially when the clamping surfaces are made of carbon! Grease will penetrate the surface of the carbon component and undermine the stability of joined parts by reducing the coefficient of friction. Greased carbon components may never again provide a safe clamping surface! When you install carbon components, apply RITCHEY Liquide Torque to interconnecting surfaces to increase friction. This will allow you to tighten bolts to low and therefore gentle torque values.

 If any notches, tears, deformations, dents or discolorations etc. are visible on your carbon component, or if it makes creaking or cracking noises, do not use the bike until the component has been replaced! After undue stress, a crash or other major impact, replace the component or have it inspected by your local RITCHEY dealer before using it again.

 If you have carbon road handlebars, do not use clip-on or aero parts, unless the handlebars are especially designed, such as the RITCHEY Pro Carbon Evo or Pro Carbon Matrix road handlebars.

## Cleaning and Care

Clean the handlebars and the stem, the bar ends as well as the grips and the bar tape with water and a soft rag at regular intervals. If necessary, use a non abrasive soap to remove grime. You may add a little detergent liquid for cleaning and removing tough stains, such as oil or grease, from hard surfaces. Do not use degreasing agents, which contain organic solvents (e.g. acetone, trichloroethylene, methylene, etc.). Chemicals of this sort may damage the finish or substructure of the material.

After your bike has dried, apply a wax based polish **(a)** to painted, carbon and metal surfaces (exception: braking surfaces). Polish the components after the wax has dried. With this treatment your handlebars, stem and bar ends will keep their nice appearance for years.

 While cleaning your bike, look for cracks, scratches, dents, as well as for deformed or discoloured material. If you think there may be a problem, see your local RITCHEY dealer. Have damaged or defective components replaced immediately.

 Make absolutely sure to keep the braking surfaces or rotors free of cleaning agent, grease or lubricants. Otherwise the braking performance might be drastically reduced or even rendered ineffective.

 Be sure to never store the handlebars and the stem in the blazing sun or near a source of heat.

 Remove the handlebar tape once a year. Clean the handlebars with water and a little liquid soap. If necessary, remove any traces of adhesive with alcohol. Inspect the handlebars for any damage or corrosion. Immediately replace corroded or damaged handlebars for your own safety.

## Maintenance

Check the torque values of all bolts after the first 100 to 300 km (60 to 180 miles) or 5 to 15 hours of use. If necessary, tighten them as prescribed with a torque wrench. Check at least every 1,500 km (930 miles) or 75 hours of use thereafter.

 Loose or overly tightened bolts may result in an accident!

After about three years the handlebars, the stem and the bar ends have aged to an extent that they need to be checked thoroughly and have to be replaced, if necessary. Ask your RITCHEY dealer for advice.



## General Notes on Installation

In general, handlebars, stem and bar end installation are jobs for skilled mechanics. We therefore recommend that you have these jobs performed by an authorized RITCHEY dealer. Each of the following instructions must be followed strictly. Non-observance of these instructions can lead to component failure, resulting in a severe accident or injuries.

 Installing non-matching components can result in bolt failure and consequently in a serious accident.

We recommend using RITCHEY handlebars, stems and bar ends together, as they are designed to fit and function as an integrated whole. If you decide to use a component from another manufacturer, read the user manual of this component regarding size accuracy to ensure proper fit and usability with RITCHEY components.

RITCHEY assumes no responsibility for problems resulting from a RITCHEY component being used with a component from another manufacturer.

Before installation watch out for sharp edges and burrs on all clamping surfaces of the handlebars, stem **(b)** and bar ends. Do not use these components, if they have burrs or sharp edges. If there are burrs or sharp edges on a RITCHEY or non-RITCHEY component, have your RITCHEY dealer inspect it to see, whether the issue can be remedied or whether the component must be replaced.

If you fit new handlebars to an existing stem, check the old handlebars carefully for scratches, abrasion marks and notches after removal. Notches in the clamping area indicate defective processing or deficient design of the stem in these areas.

 Do not use components, if you are not absolutely sure about their compatibility. In case of any doubt, ask your RITCHEY dealer who will contact, if necessary, our after-sales service hotline.

 Do not use further damaged components. If you have the slightest doubt, we recommend that you replace the component. Do not use your bike until this has been done.

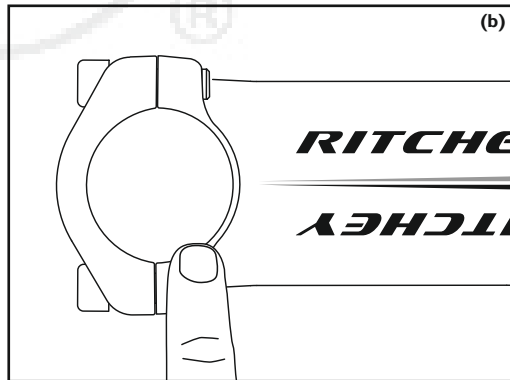

## RITCHEY Liquid Torque

### Installing components with RITCHEY Liquid Torque

Carbon fiber components are particularly vulnerable to damage caused by excessive clamping force. RITCHEY Liquid Torque **(c)** creates extra friction between two surfaces, allowing the necessary clamping force to be reduced by up to 30 %.

This is especially useful in the clamping areas of handlebars and stem or fork steerer tube and stem, i.e. two areas where too much clamping force can damage either component, causing component failure or voiding the warranty. Carbon components are particularly sensitive to crushing as a result of too high clamping force. By reducing the clamping force, RITCHEY Liquid Torque relieves stress on sensitive carbon surfaces, preventing damage to fibers or the cracking of the carbon substructure. It also retains its effectiveness in wet conditions and provides maximum protection against corrosion.

RITCHEY Liquid Torque can be used for all carbon, aluminum and steel connections including:

- stem/handlebars clamping areas
- stem/steerer tube clamping areas
- seat post/frame clamping areas

RITCHEY Liquid Torque is ideal for this purpose, as it does not harden.

### Precautions for use

Prior to applying RITCHEY Liquid Torque, remove dirt particles and lubricant residues from the surfaces to be treated. Next, apply a thin and even film of RITCHEY Liquid Torque to the cleaned surfaces using a brush, lint-free rag or chamois. Install components as directed by the manufacturer, by using a torque wrench (such as the RITCHEY Torque Wrench recommended for use with all RITCHEY handlebars and stems) and do not to exceed the manufacturer's maximum torque values. Remove excessive Liquid Torque and re-seal the RITCHEY Liquid Torque container after use.

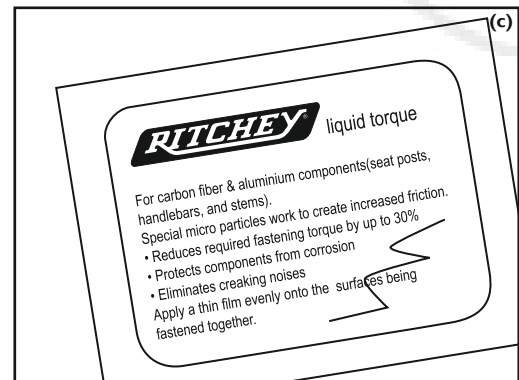

### Additional information

Many manufacturer warranties will not cover damage to component due to overtightening. Refer to manufacturer's recommended torque limits for each component. Always use a torque wrench to verify you are within specified torque limits, and do not exceed them. Using RITCHEY Liquid Torque will allow you to safely install your bicycle components – particularly in the case of carbon fiber – without exceeding the torque limits specified by the manufacturers. In most cases, using RITCHEY Liquid Torque will enable you to use as much as 30% less torque while installing your components.

 RITCHEY Liquid Torque is neutral to copper and aluminum alloys, steel and synthetic material, and will not damage product surfaces.

 For detailed information about RITCHEY Liquid Torque, visit the online shop of RITCHEY International at [www.ritchey.ch](http://www.ritchey.ch).

## RITCHEY Torqkey

To achieve long lasting and problem-free clamping of components, RITCHEY considers the use of a torque wrench absolutely necessary. The RITCHEY Torqkey **(d)** is designed for use with all RITCHEY road and mountain bike stems, handlebars and bar ends. It is a 4 mm hex bolt/Allen wrench pre-set to 5 Nm, which is both the ideal clamping force as well as the maximum prescribed torque, used to tighten RITCHEY stem, handlebars and bar ends bolts. If 5 Nm of torque does not generate sufficient clamping force, apply RITCHEY Liquid Torque to interconnecting surfaces to increase friction.

Exceeding 5 Nm of torque on clamp bolts of stem, steerer tube or handlebars creates too much clamping force, which can lead to component failure. This not only bears a high risk of accident, but also voids the warranty.

 Loose or overly tightened bolts can result in component failure and in an accident. Strictly observe the torque specifications. If you do not have a high-quality torque wrench or a RITCHEY Torqkey, see your local RITCHEY dealer.

 For detailed information about the RITCHEY Torqkey, visit the online shop of RITCHEY International at [www.ritchey.ch](http://www.ritchey.ch).

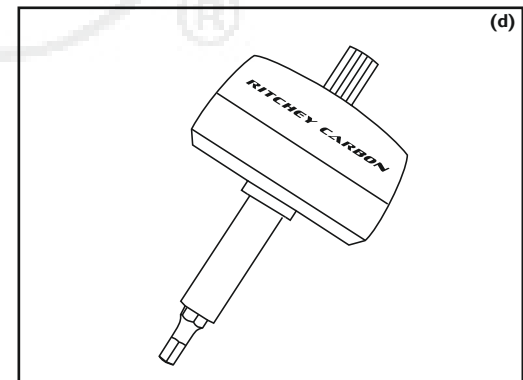

## RITCHEY Torque Wrench

 For bolts tightened to another torque than 5 Nm, please use the RITCHEY Torque Wrench.

The RITCHEY Torque Wrench is suitable for torque settings from 2 Nm (e.g. for small aluminum bolts) to 16 Nm (e.g. for M6 bolts at some seat posts).

 For detailed information about RITCHEY Torque Wrench, visit the online shop of RITCHEY International at [www.ritchey.ch](http://www.ritchey.ch).

## Installing Aheadset®-Stems

Many RITCHEY stems can be installed in either vertical orientation. These flip-flop models allow handlebars to be positioned at two different heights by simply inverting the stem (a).

Verify that the stem and fork steerer tube always have matching or compatible clamp diameters (b):

If you fit a new stem on a fork with carbon steerer tube, check the clamping area for notches or abrasion marks. In case such damage is actually visible, ask your RITCHEY dealer whether it is necessary to have the fork replaced.

Make sure the clamping areas are absolutely free of grease, especially when the clamping surfaces are made of carbon. Use RITCHEY Liquid Torque at the clamping areas to optimize clamp hold.

Grease the threads and the connecting surfaces/heads of the steerer clamp bolts. Do not apply lubricants to the clamping surfaces.

Slide the stem onto the fork steerer tube. It must fit snugly onto the fork. Do not fit stems which have play on the steerer tube.

Depending on the steerer tube length and the desired stem position, install spacers on the fork steerer above the upper cover of the headset, and/or above the stem (c). You can stack them up to a maximum height of 30 mm.

Spacers are available in different heights. You have installed the correct number of spacers, when the steerer tube ends 2 mm below the top edge of the stem.

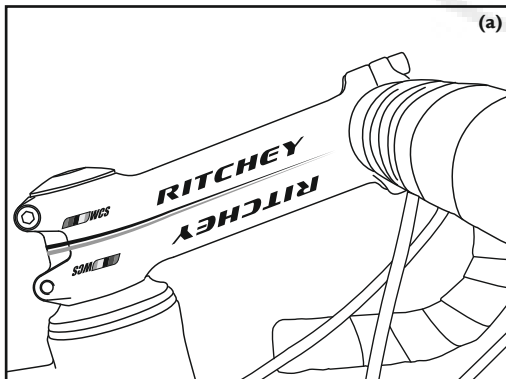

Make sure the stem provides sufficient support for the steerer tube and that the steerer tube ends 2 mm at the most below the top edge of the stem. This ensures a reliable clamping when tightening the clamping bolts of the steerer tube clamp to the prescribed torque setting.

If your preferred stem height results in a deeper position of the stem on the steerer tube, the steerer tube projects from the stem. To check whether you have found the proper position, slide spacers on the steerer by making sure that the steerer tube ends 2 mm below the top edge of the stem. After the test ride the steerer tube of a carbon fork must be shortened.

 The space between the top of the steerer tube and the upper edge of the stem should not exceed 2 to 3 mm (d). Tighten the stem bolts only a little, if you intend to install the handlebar right afterwards. Finish by adjusting the headset.

 The clamp bolts of RITCHEY stems are designed to oppose each other for proper load distribution during clamping. Please check that the bolt heads of RITCHEY stems are always oriented in opposition to each other.

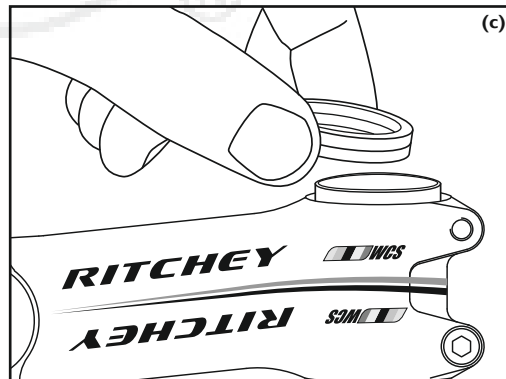
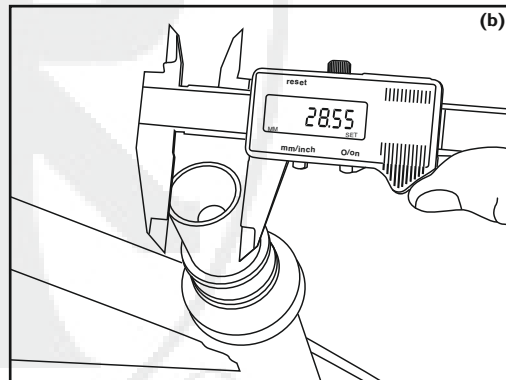

## Adjusting the Aheadset®-Headset

 Adjusting the headset is a job for a skilled mechanic. Have this work done by an authorized RITCHEY dealer. If you intend to do the adjustment on your own, read the user manual of the headset manufacturer first and note that you need special tools, e.g. a RITCHEY Torqkey.

Release the clamping bolts on the stem side by two to three turns without unscrewing them entirely.

The Allen bolt located in the top cap is intended to re-adjust the bearing play (e). Turning the bolt clockwise removes play, as the stem is pressed downward on the bearing; turning the bolt anticlockwise increases the play. In case there is bearing play, tighten the adjusting bolt by another quarter or half a turn.

Check the headset for play as described in the user manual of your bike (f). Do not overtighten the headset; otherwise there is the risk of headset failure.

 Do not overtighten the top Allen bolt, it is intended for adjustment! Tighten the bolt carefully in quarter-turns and check the play regularly.

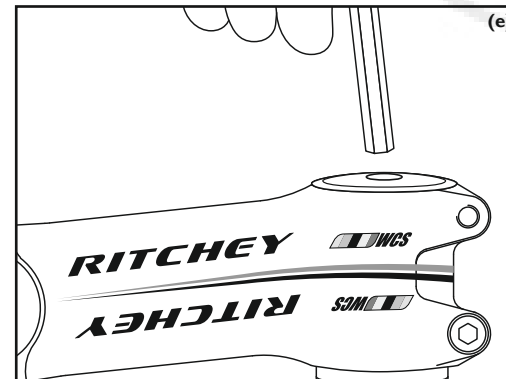
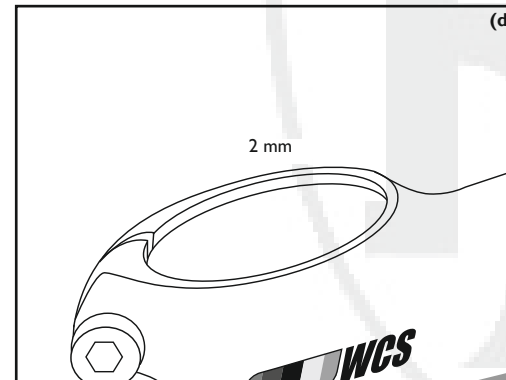

Once the play is properly adjusted, align the stem in the direction of motion. Check the alignment of frame and stem with the front wheel from the top. The handlebars should be at right angle to the direction of motion.

Tighten both clamping bolts alternately by using the RITCHEY Torqkey. If you use a standard torque wrench, start with a minimum tightening torque of 4 Nm (g). In case the stem clamping is not tight enough, increase the tightening torque to 5 Nm or until the RITCHEY Torqkey clicks.

 With carbon steerer tubes, make sure the inside of the tube is supported by an expander-cone mechanism for adjusting the headset. Strictly observe the instructions given in the user manual of the fork manufacturer before tightening the stem.

 After adjusting the headset check the tight clamping of the stem by holding the front wheel between your knees and trying to turn the handlebars relative to the front wheel. A loose stem can lead to an accident!

 If the stem cannot be tightened on the fork steerer tube to a tightening torque of 5 Nm, in spite of RITCHEY Liquid Torque on the clamping surfaces, stem and fork are incompatible. Replace the stem by a matching model or ask your RITCHEY dealer for assistance.

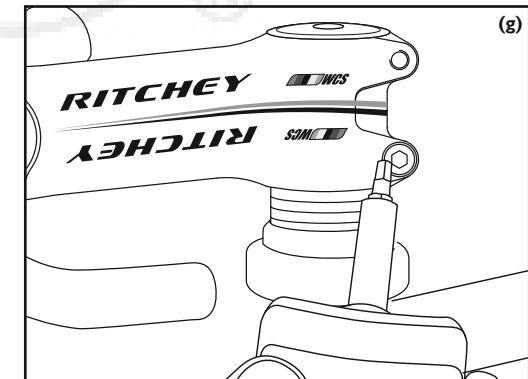
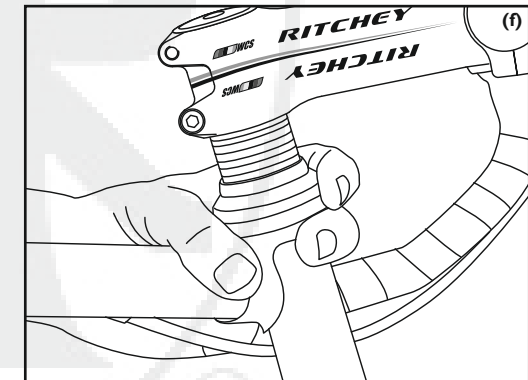



## Installing the Handlebars

Before you start installation verify that the stem you have chosen has a clamping diameter matching the handlebars.

Stems with a 31.8 mm clamping are for example only compatible with handlebars with a clamping diameter of 31.8 mm.

Position the stem clamp in the middle of your new RITCHEY handlebars so that the handlebars extend the same distance from the stem on each side. If the handlebars do not slide easily into the stem clamp or if there is play between the two components, ask your RITCHEY dealer whether both components are compatible.

Mountain bike handlebars are normally mounted with the sweep supporting a natural ergonomic hand position, i.e. bent slightly rearward. The handlebar position is correct when your wrists are relaxed and your elbows not flared out too much.

In the case of road bikes the straight piece of the drops should be in parallel to the ground or point with the ends slightly downwards.

Tighten the greased bolts of the stem faceplate with your fingers by a few turns. Gently tighten all four bolts with a RITCHEY Torqkey or another quality torque wrench until they are snug and verify that the upper and lower clamping slots are identical in width. Do not exceed the prescribed torque settings **(a)**.

Tighten the fixing bolts evenly in a cross pattern, i.e. alternately and in small increments to the minimum limit of the recommended torque settings.

The recommended maximum torque setting for RITCHEY 4-bolt stems is 5 Nm **(b)**. Always use the RITCHEY Torqkey and observe the torque settings indicated on the component in case of doubt.

Check the shift/brake lever controls or the brake levers for burrs and sharp edges. Do not use shifters or brake levers with burrs or sharp edges to prevent your handlebars from damage and dents. Components that are affected by burrs and sharp edges should be checked by a RITCHEY dealer. They will see, whether this is a problem that can be solved or whether the component has to be replaced. Loosen clamping bolts completely to ensure clamps are open all the way before sliding the shifters and brake levers onto the handlebars.

In the case of road bike shift/brake lever controls (Dual Control, Ergopower or DoubleTap) dismount the clamp completely from the control.

Start tightening the clamping bolts slightly, so that the controls can still rotate freely. Bring the controls to the desired position. Tighten the bolts to the prescribed torque value to ensure a reliable hold **(c)**.

Never rotate the controls on the handlebars after you have tightened the clamping bolts. Otherwise you will scratch the surface and mar the finish. In addition you run the risk of damaging the material.

 Read through the manufacturers' user manuals of all components before you follow the above instructions.

 Never shorten carbon fiber mountain bike handlebars by cutting off the ends, as the handlebars are generally reinforced in the clamping areas of the shift/brake lever controls. Shortening handlebars by cutting off the ends can damage the handlebars and result in an accident during use! Any modification to a RITCHEY carbon component will void the warranty.

 If you have a C260 stem, please read the additional instructions in chapter "C260 Stems".

## Mountain Bike – Adjusting Controls and Levers

Turn the loosened controls on the handlebars so that they show slightly downward. Sit on the saddle and place your hands on the controls with your fingers on the brake levers.

The back of your hands should form a straight line with your forearms. With your hands in the correct position adjust the shift levers accordingly **(d)** and tighten the clamping bolts of the brake and shift lever controls to the recommended torque values.

## Road Bike – Adjusting the Handlebars

In the case of road bikes the straight piece of the drops should be in parallel to the ground or point with the ends slightly downwards **(e)**. Verify the tight fit of the handlebars in the stem by trying to rotate them.

You should not be able to rotate the handlebars **(f)**. Never exceed the torque value recommended by the manufacturer.

In case the handlebars are not tight, check that each bolt was tightened to the recommended torque value (5 Nm for RITCHEY stem clamp bolts). If each bolt was tightened to a torque value of 5 Nm and the clamping force is still insufficient, release the bolts, remove the handlebars from the stem and apply RITCHEY Liquid Torque to the clamping areas.

Retighten each bolt individually to a torque value of 5 Nm. If the handlebars are still not tight in the stem, contact your RITCHEY dealer or ask a skilled mechanic for advice.

Check the adjustment of the brake/shift levers, if necessary, as described in section "Installing the Handlebars".

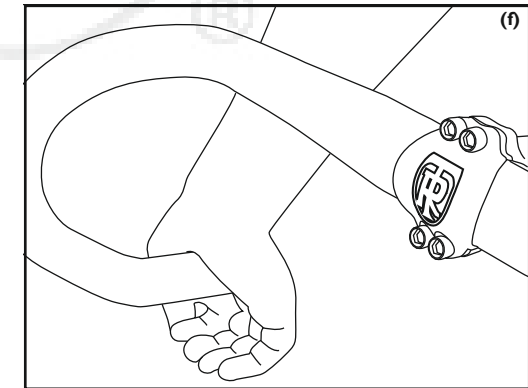
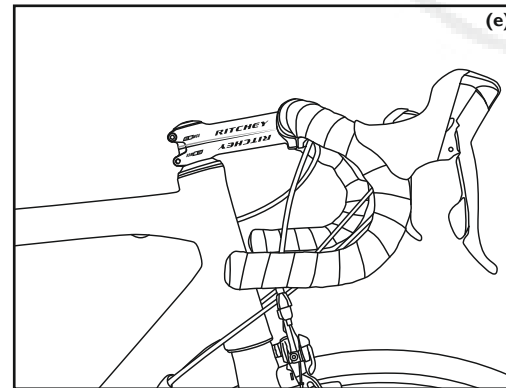
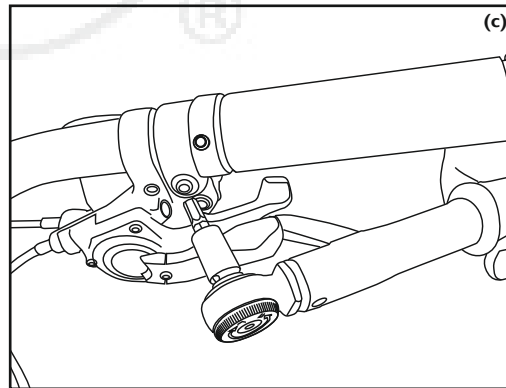
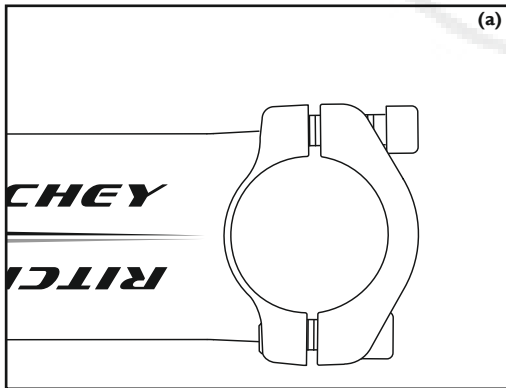
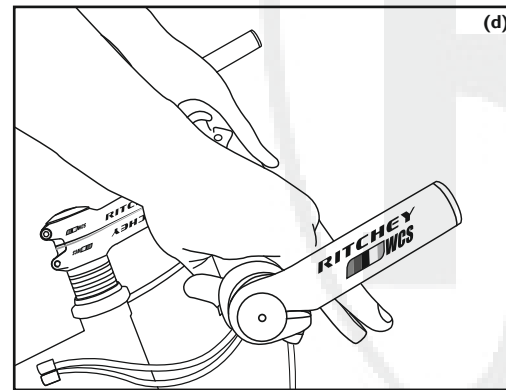
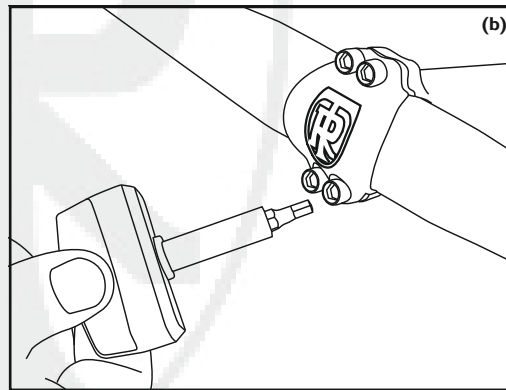

## Installing Bar Ends

Bar ends add more hand positions to your handlebar configuration. They are usually set to a position that provides more leverage and more comfort when you pedal out of the saddle.

RITCHEY bar ends are suitable for usage with almost all RITCHEY handlebars, regardless of whether they are made of aluminum or carbon.

 RITCHEY SuperLogic mountain bike handlebars are not suitable for being fitted with bar ends!

If you intend to install RITCHEY bar ends on non-RITCHEY handlebars, make sure first that the handlebars are suitable for being fitted with bar ends. In case of doubt ask your RITCHEY dealer for advice.

 Mounting bar ends to unsuitable handlebars, i.e. handlebars with thin wall thicknesses that are not designed to withstand the specific load, can lead to handlebar failure during use and result in an accident!

Verify that the clamping areas of the bar ends are free of burrs and sharp edges. Do not use bar ends with burrs or sharp edges. Burrs are sharp and can cut into other components. If there are any burrs or sharp edges, contact your RITCHEY dealer.

Release the clamping bolts of the brake/shift lever controls and slide them together with the handlebar grips towards the centre of the handlebars until there is enough space to install the bar ends. If the grips have end caps, cut them before you move the grips.

Do not use any liquids or grease to loosen the grips; if necessary, use compressed air to loosen them.

Loosen the bar end bolts on the bottom side of the bar ends by two to three complete turns.

Slide the bar ends on the respective side of the handlebars (a). Angle the bar ends according to personal preference and make sure they are both at the same angle (b). Observe possible right/left references on the bar ends.

Retighten the bolts carefully in small increments of 0.5 Nm. Do not exceed the maximum torque value of 5 Nm for the clamping bolts of RITCHEY bar ends or bar ends used with RITCHEY handlebars.

Never exceed the maximum torque indicated on the components (c).

 If a tight fit of the bar ends on the handlebars cannot be achieved in spite of using RITCHEY Liquid Torque on the contact surfaces, the bars ends and the handlebars are not compatible. Replace the bar ends or the handlebars by appropriate models.

 The interfacing clamping areas of stems, handlebars, bar ends, shift and brake levers must be tightened to specified torque settings.

 Installing unsuitable bar ends to RITCHEY handlebars can lead to sudden failure during use and therefore result in an accident. Highly conifed handlebars and handlebars made of carbon are mainly not suitable for bar ends. Ask your RITCHEY dealer for advice.

## Adjusting the Handlebar Height

Both the handlebar height and the stem length determine how much your upper body will be inclined forward (d). Lowering the handlebars gives the rider a streamlined position and brings more weight to bear on the front wheel. An excessively low handlebar position may prove less comfortable, especially on longer rides, and can strain wrists, arms, upper body and neck.

Seek the assistance of a qualified bike fit expert, especially if you experience pain or discomfort after set up and use. If necessary, your RITCHEY dealer can help you with our FIT LOGIC BY RITCHEY program that gives you an overview of the available RITCHEY products and sizes finding the ideal seating position for you that satisfies your needs.

## Aheadset®-Stems

### Readjusting the Aheadset® by Using Spacers

On bikes using a threadless headset system, or Aheadset®-system, the stem is an integral part of the headset. To modify the seating position the stem can be dismounted and re-mounted. Subsequently, the headset must be re-adjusted (see chapter “Adjusting the Headset”).

The vertical position of the stem is determined by the arrangement of the spacers. In the case of flip-flop models (e) it is also possible to reverse the stem in order to achieve a higher or lower position of the handlebars.

Loosen the headset cap bolt at the top of the fork steerer tube (f). This cap serves to adjust the bearing preload. Remove the cap and loosen the stem's steerer clamp bolts, then pull the stem up and off the steerer tube. Now you can remove the spacers. Reposition the spacers on the steerer tube above and below the stem (g) in order to position the handlebar at the desired height.

Check the reliable fit of all components, as described above.

 Keep in mind not to position more than 30 mm spacers below the stem.

 If you want to reduce the number of spacers, you have to shorten the steerer tube. This shortening is irreversible. Cutting the steerer tube is a job for a skilled mechanic. Have this work performed only after you have found the ideal position. Instead of shortening the steerer tube you have also the option to modify the arrangement of the spacers. Make a test ride and place the equal number of spacers you have removed from below the stem above the stem and vice versa.

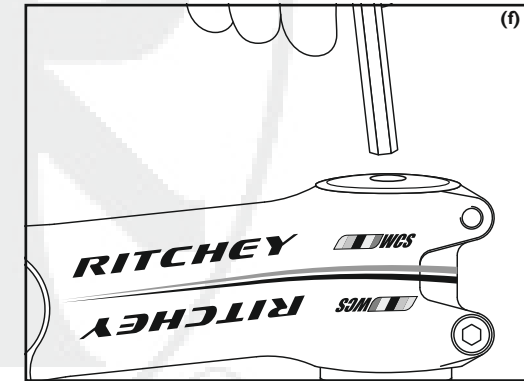
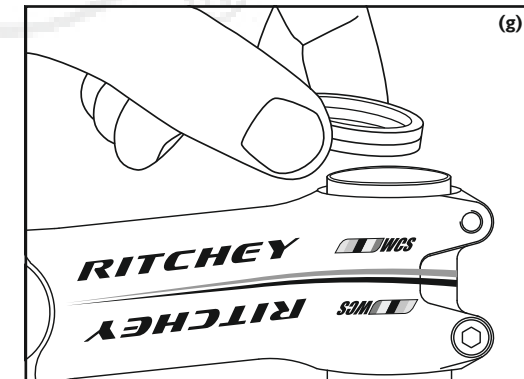
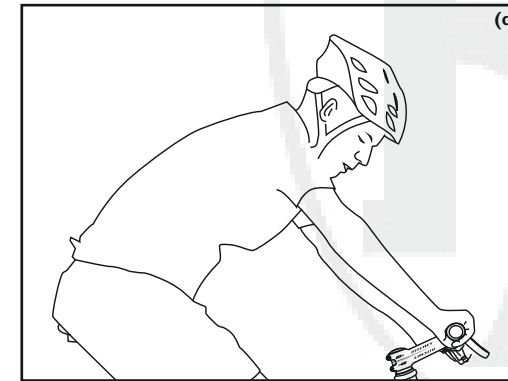
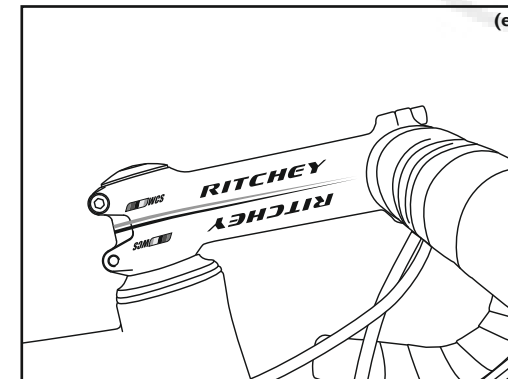
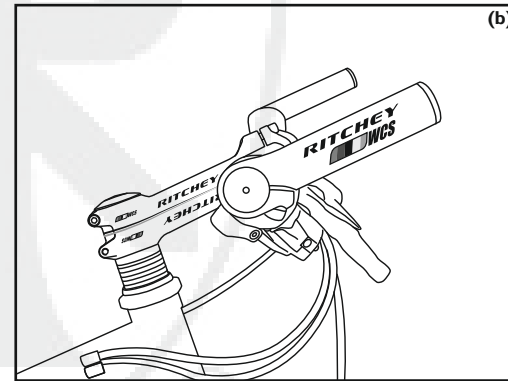
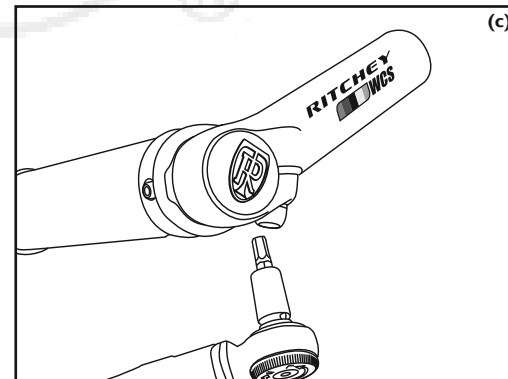
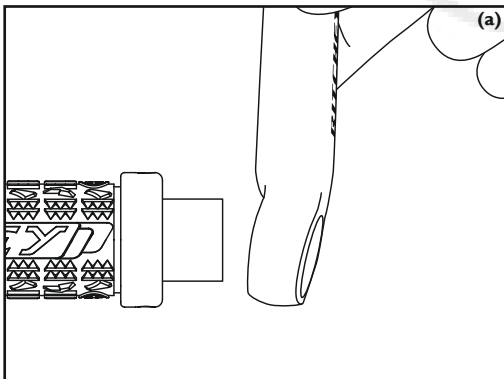

## Adjustable Stems

In the case of adjustable Aheadset®-stems (a) you can vary the height of the handlebars by changing the tilt of the front part of the stem.

**i** After you have changed the height of the handlebars, make sure to also re-adjust the headset. If you are not sure whether you can perform this adjustment, ask your RITCHEY dealer for help.

Release the lateral bolt (b) for the angle adjustment until the ratchet mechanism disengages and open the steerer tube clamping. Undo both parts of the clamping so that you are able to bring the stem into a new position (c). Re-assemble both parts by making sure the ratchet mechanism interlocks properly and remount the bolt. Retighten it to the recommended torque value (d).

When you have determined the position of your stem, you should also change the position of the handlebars, as described in chapter "Installing the Handlebars". To do so, release the bolts of the stem's faceplate and turn the handlebars. Retighten the bolts to a maximum torque value of 5 Nm.

Adjust the headset, as described in chapter "Adjusting the Headset".

**i** Keep in mind that when changing the position of the stem you also change the position of the handlebars including brake and shift levers and bar ends, if mounted. Readjust the position of the handlebars, as described in chapter "Installing the Handlebars".

**⚠** Make sure to properly tighten the bolts of stem and handlebars. Non-observing the prescribed torque settings can result in handlebar or stem failure.

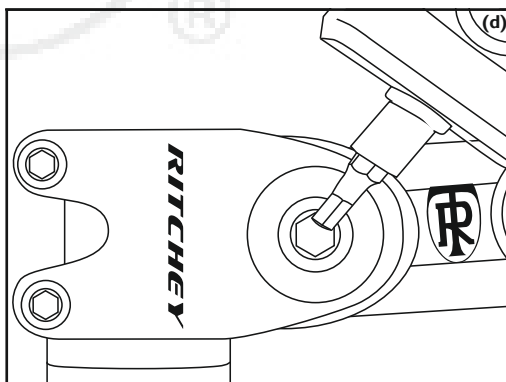
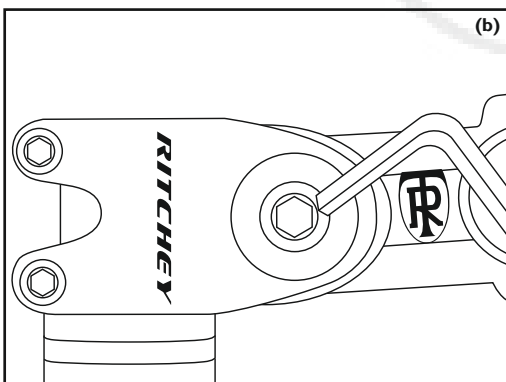
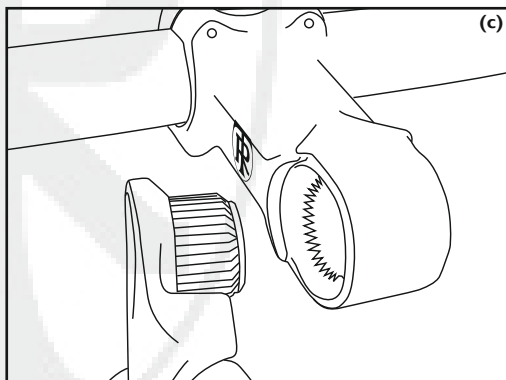
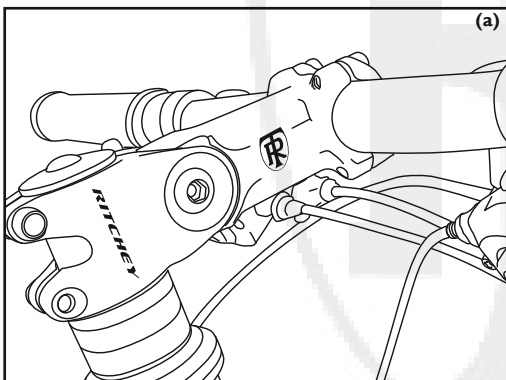

## C260 Stems

**⚠** We strongly recommend using RITCHEY stems only with RITCHEY handlebars to ensure optimum performance and durability. Although RITCHEY C260 stems are designed to be theoretically compatible with most handlebars, some makes/models may not fit. **Risk of Accident!**

**⚠** Do not force the stem onto a bar, as scratching or damage may occur.

4) Carefully slide the stem over the center section of the bar and rotate the stem by 180 degrees to the proper riding position (h).

5) Adjust the stem in the center of the clamp according to your preferred riding position and torque the bolts to the specifications indicated in chapter "Stem Tightening" (i).

### Stem to Bar Installation

#### A) Road bar with ergonomic top section

- 1) Remove the faceplate and the bolts. Peel the bar tape back to the hoods, if necessary. Insert the stem onto the bar near the outer portion of the bend (e).
- 2) Rotate the stem body by 180 degrees to face inward towards the center of the bar (f).
- 3) Carefully work the stem towards the center of the bar to avoid damage. Do not use excessive force to compensate for the increased friction that may occur (g).

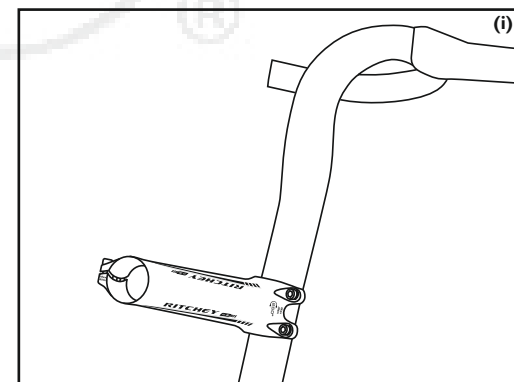
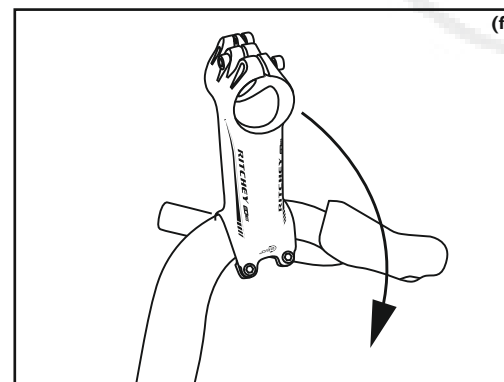
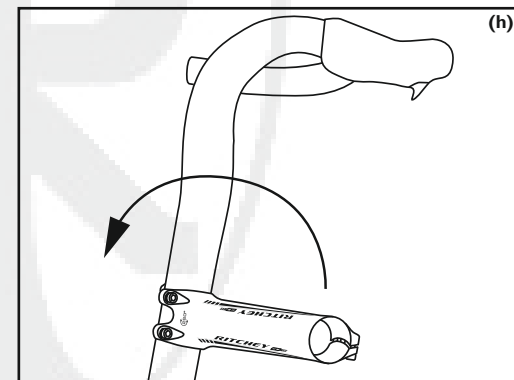
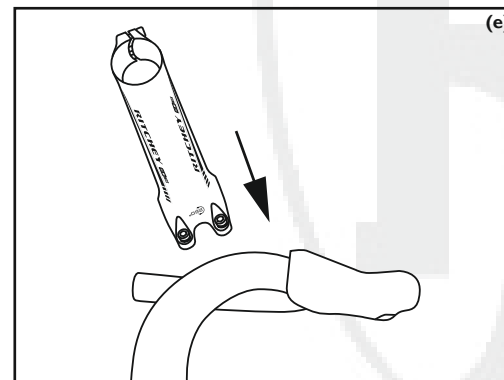
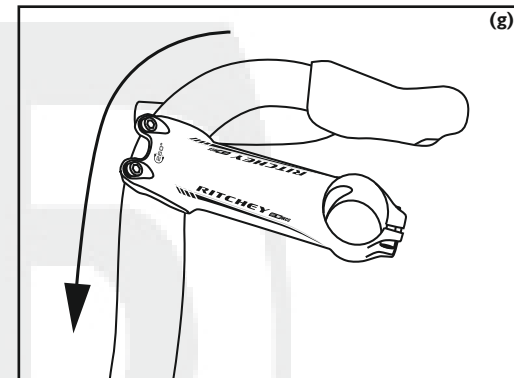

### B) Standard road bars

- 1) Remove the faceplate and the bolts. Peel the bar tape back to the hoods, if necessary. Insert the stem onto the bar on either side of the oversize center section of the bar (a).
- 2) Carefully slide the stem over the center section of the bar. Adjust the stem in the center of the clamp according to your preferred riding position and torque the bolts to the specifications indicated in chapter "Stem Tightening" (b).

### C) Mountain flat / rise bar

- 1) Remove the faceplate and the bolts. Insert the stem onto the bar on either side of the oversize center section of the bar (c).
- 2) Carefully slide the stem over the center section of the bar. Adjust the stem in the center of the clamp according to your preferred riding position and torque the bolts to the specifications indicated in chapter "Stem Tightening" (d).

### Stem Tightening

 Use a torque wrench to ensure the bolts are secured to the proper torque specifications

#### Step 1

With the bar and stem mounted on the bike adjust them according to your preferred riding position. Start by tightening the steerer clamp bolts gently and evenly and only then to a maximum torque of 5 Nm (e).

#### Step 2

Start by tightening the handlebar clamp bolts gently and evenly to ensure the upper and lower gap between stem and faceplate is identical in width. Retighten the bolts only then in an alternating pattern (f) to a maximum torque value of 5 Nm.

## Installing and Adjusting Aero Bars

### WCS Carbon Hammerhead TT Base Bar

The WCS Carbon Hammerhead TT Base Bar is installed to regular stems, as described in section "Installing the Handlebars". Make sure to install the handlebars in parallel to the ground or with a slight upward tilt.

It is recommended to opt for a shorter stem than you would use with a regular road bar. Take your time to find out the ideal position for you and ask your RITCHEY dealer for advice.

 The Hammerhead base bar is not compatible with Shimano Dual Control, Campagnolo Ergopower or SRAM Double Tap brake/shift levers. Specific time trial brake levers and bar end shifters are not necessary!

Release the clamping bolts at the bottom side of the clamp devices and slide the extensions into these clamps. Bent extensions should be installed with the RITCHEY logo outside. The extensions can be moved towards the front or backwards until you are comfortable in your desired seating position. Make sure the extensions are always fully inserted in the clamps. Tighten the clamping bolts of the extensions only slightly so that they can still be moved into the desired position.

Remove both carbon arm rests and release the clamping bolts of both handlebar clamp devices. Remove the clamp devices, install them in the desired position at the elliptical part of the base bar and retighten the clamping bolts to a maximum torque value of 5 Nm (g).

Subsequently, install the carbon arm rests on the clamp devices and slightly tighten their bolts. Determine the optimal angle of the carbon arm rests and tighten the bolts to a maximum torque of 5 Nm (h).

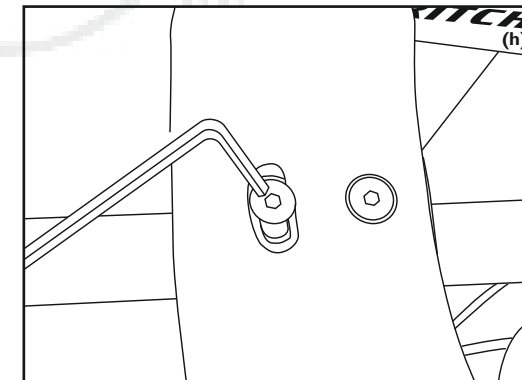
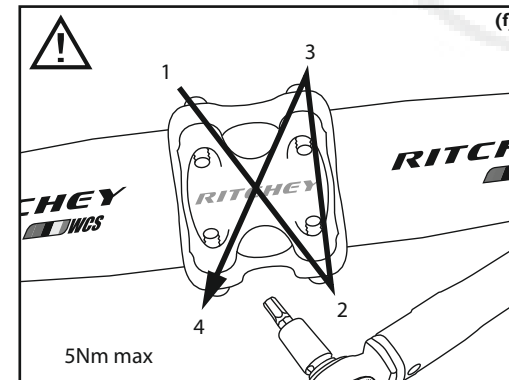
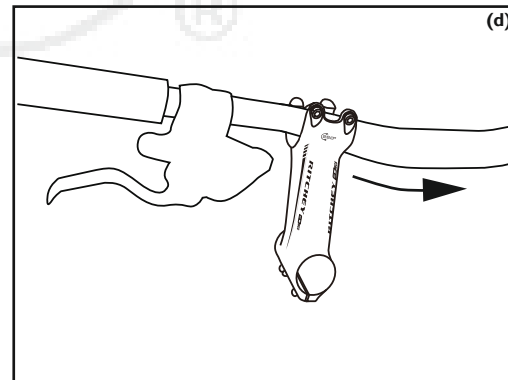
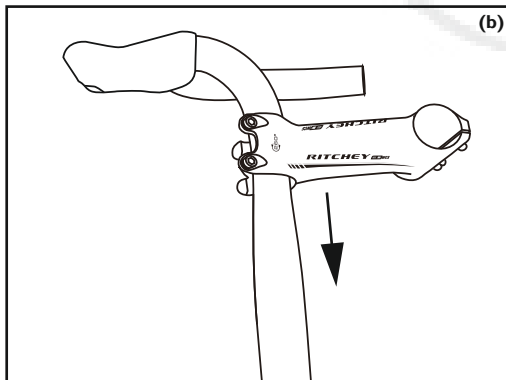
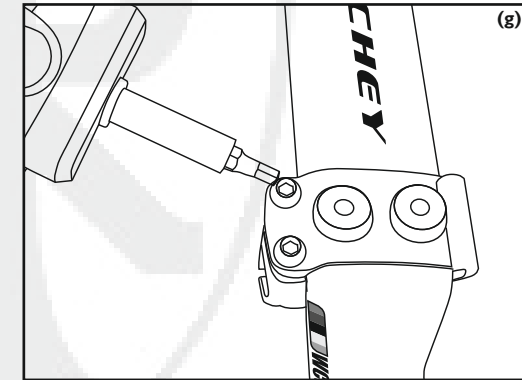
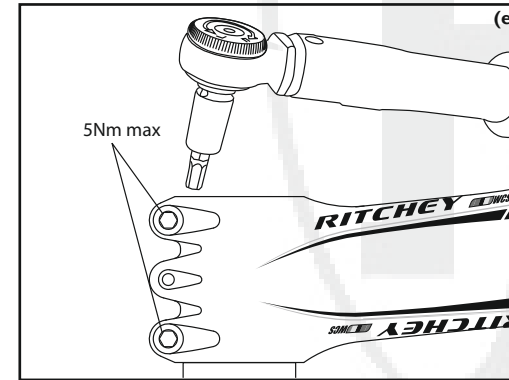
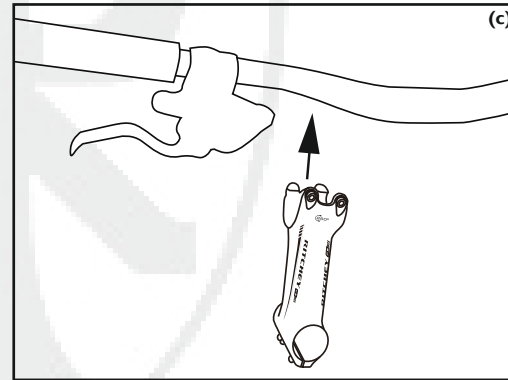
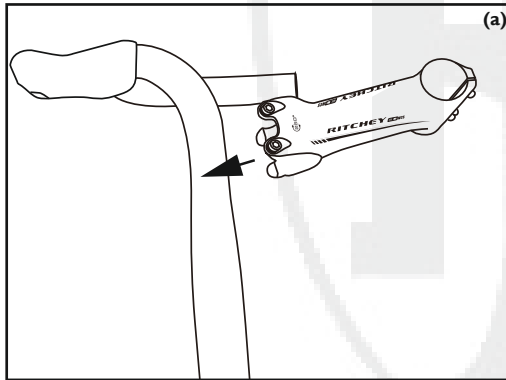





Once you have found the optimal seating position, tighten the clamping bolts of the extensions in half turns until the extensions are tight and can no longer be turned **(a)**. Never exceed the prescribed torque value of 5 Nm.

Finish by removing the protective film from the rest pads and fix them in the desired position on the carbon arm rests.

The brake cables run over the first centimetres through the handlebars before they come out of the respective hole. In the case of bar end shifters the shift cables are conducted entirely along the extensions.

 Read the user manual of the brake and shift lever manufacturer before you install them according to the instructions.

 After you have found your final seating position it may be that you have to shorten the extensions. This is a job you should have performed by your RITCHEY dealer.

 Make sure the extensions are clamped over the entire possible length. Otherwise the aero bars may fail during use. **Risk of Accident!**

 Wrap the RITCHEY bar tape around the grip area of the aero extensions to ensure a firm grip during riding.

## WCS Carbon Interval Base Bar

Install the Interval Base Bar, as described in chapter “Installing the Handlebars”. Make sure the straight grip part of the handlebars is about in parallel to the ground or with a slight upward tilt.

 The Interval Base Bar is not compatible with Shimano Dual Control, Campagnolo Ergopower or SRAM Double Tap brake/shift levers. Specific time trial brake levers and bar end shifters are not necessary!

The brake cables run over the first centimetres through the handlebars before they come out of the respective hole. In the case of bar end shifters the shift cables are conducted entirely along the extensions.

## Pro Base Bar

Install the Pro Base Bar, as described in chapter “Installing the Handlebars”. Make sure the straight grip part of the handlebars is about in parallel to the ground or with a slight upward tilt.

 The Pro Base Bar is compatible with Shimano Dual Control, Campagnolo Ergopower or SRAM Double Tap brake/shift levers. Most specific brake/shift levers are also compatible with the Interval Base Bar, whereas most bar end shifters are compatible with RITCHEY aero extensions. Read the respective user manual to be on the safe side.

The brake cables should run along the front side of the handlebars, as usual. The shift cables can enter through the opening (outside) into the bar bend, before coming out through the opening on the bottom side. As an alternative the shift cables can also be conducted in parallel to the brake cables. In the case of bar end shifters the shift cables are conducted entirely along the extensions.

The WCS Carbon Interval Base Bar and the Pro Base Bar can be combined with the arm rests **WCS “Wedge” Carbon-Alloy** and **WCS “Sliver” Carbon-Alloy**.

 Read the user manual of the brake and shift lever manufacturer before you install the controls according to the instructions.

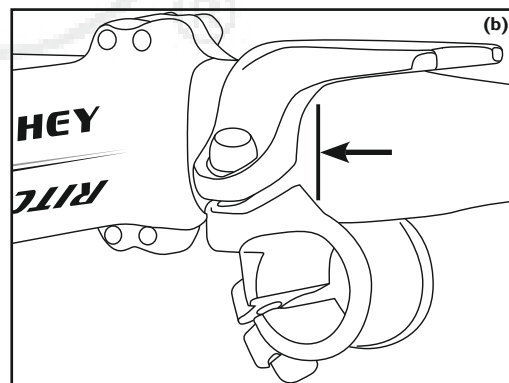
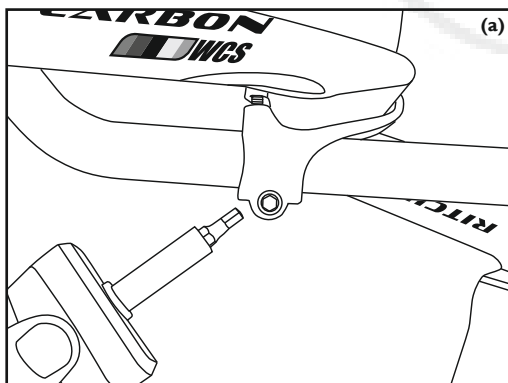

## Installing the Arm Rests WCS “Wedge” Carbon-Alloy

Release the handlebar clamping bolts of the Wedge clamp devices. Disassemble the handlebar clamps in its two components, position them around the cylindrical centre part of the handlebars **(b)**, engage the front parts and slightly tighten the handlebar clamping bolts. Make sure the platforms for the carbon arm rests point to the outside and the clamping bolts for the extensions under the handlebars show to the inside.

Release the clamping bolts for the extensions and slide the extensions into these clamps. Bent extensions should be installed with the RITCHEY logo outside. The extensions can be moved towards the front or backwards until you are comfortable in your desired seating position. Make sure the extensions are always fully inserted in the clamps. Tighten the clamping bolts of the extensions only slightly so that they can still be moved into the desired position.

Remove both carbon arm rests and determine their optimal position. You can determine the distance between your arms by means of the front bolts. The rear bolt is intended to vary the angle of your arm position. Retighten the bolts to a maximum torque value of 3 to 4 Nm **(c)**.

Once you have found the optimal seating position tighten the handlebar clamping bolts of the wedge clamp device to a maximum torque value of 6 to 7 Nm. Tighten the clamping bolts of the extensions in half turns until the extensions are tight and can no longer be turned **(d)**. Never exceed the prescribed maximum torque value of 4 to 5 Nm.

Finish by removing the protective film from the rest pads and fix them in the desired position on the carbon arm rests.

Once you have found your ideal seating position after a test ride, mark both extensions with a touch-up stick where they must be shortened. Remove both extensions and cut them off at the mark. Deburr the cutting edges and reinstall the extensions, as above described.

 Make sure the extensions are clamped over the entire possible length of the “Wedge” clamps. Otherwise the aero bars may fail during use. **Risk of Accident!**

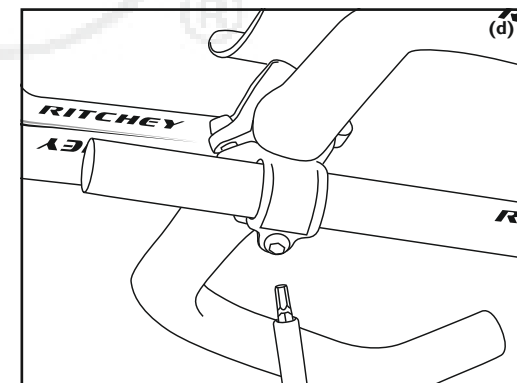
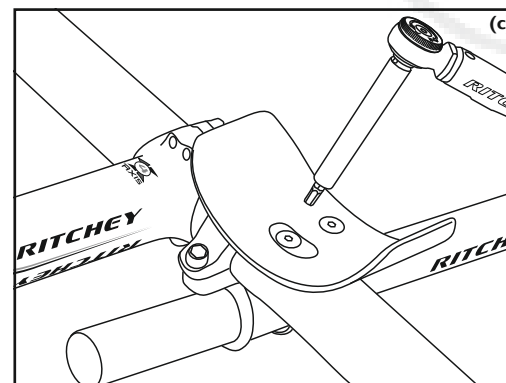



## Installing the Arm Rests WCS “Sliver” Carbon-Alloy

Release the handlebar clamping bolts of the Sliver clamp devices. Remove the bottom brackets of both devices, position the arm rests and brackets around the cylindrical centre part of the handlebars (a) and slightly tighten the handlebar clamping bolts. Make sure the platforms for the carbon arm rests and the clamping bolts for the extensions under the handlebars point to the outside.

Release the clamping bolts for the extension clamps and slide the extensions until stop into these clamps. Bent extensions should be installed with the RITCHEY logo outside. The extensions cannot be moved towards the front or backwards until you are comfortable in your desired seating position. If necessary, the extensions may be shortened. This is a job you should have performed by your RITCHEY dealer.

Remove both carbon arm rests and determine their optimal position. The “Sliver” model offers you five possibilities of adjusting the distance between your arms. It does not allow changes to the arm angle! Bring the arm rests into the desired position and retighten both bolts to a maximum torque value of 3 to 4 Nm (b).

Once you have found the optimal seating position tighten the handlebar clamping bolts of the Sliver clamp device to a maximum torque value of 6 to 7 Nm. Make sure the clamping slots in the front and rear are identical in width. Tighten the clamping bolts of the extensions in half turns until the extensions are tight and can no longer be turned (c). Never exceed the prescribed maximum torque value of 3 to 4 Nm.

Finish by removing the protective film from the rest pads and fix them in the desired position on the carbon arm rests.

 Make sure the extensions are fitted until stop in the “Sliver” clamps. Otherwise the aero bars may fail during use. **Risk of Accident!**

 Make sure the clamp devices are clamped over their entire width on the cylindrical centre part of the handlebars and not too far outside (a+d). This is the only way of ensuring a durable and secure fit of the aero extensions. **Risk of Accident!**

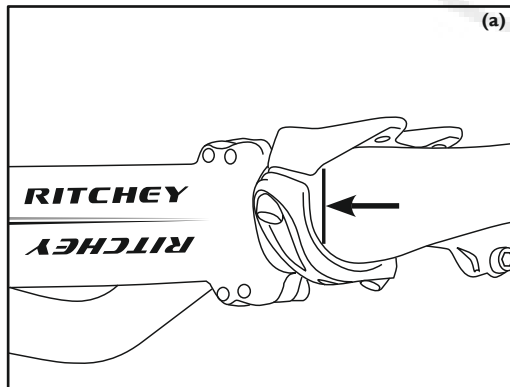

 RITCHEY offers four different extension models: two models made of carbon (**Carbon TT S-Bend Extension 340 mm** and **Carbon TT 376 mm Extension Straight**) and two made of aluminum (**Pro Alloy TT Extension S-Bend 400 mm** and **WCS Alloy TT Extension L-Bend**).

 After you have found your final seating position it may be that you have to shorten the extensions. This is a job you should have performed by your RITCHEY dealer.

 On RITCHEY carbon extensions the aluminium sleeve is designed for mounting the shift levers. Do not shorten in this area!

 Wrap the RITCHEY bar tape around the grip area of the aero extensions to ensure a firm grip during riding.

 Make sure the clamping areas are absolutely free of grease and other lubricants, especially when the clamping surfaces are made of carbon! When you install carbon components, apply RITCHEY Liquide Torque to interconnecting surfaces to increase friction.

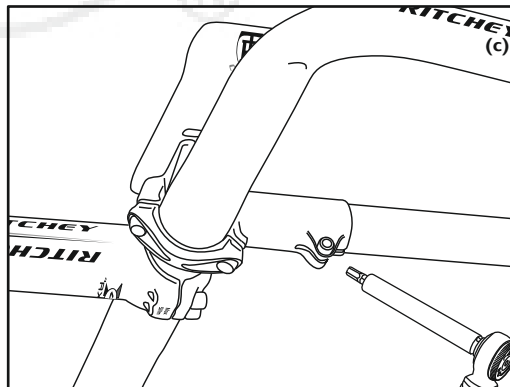
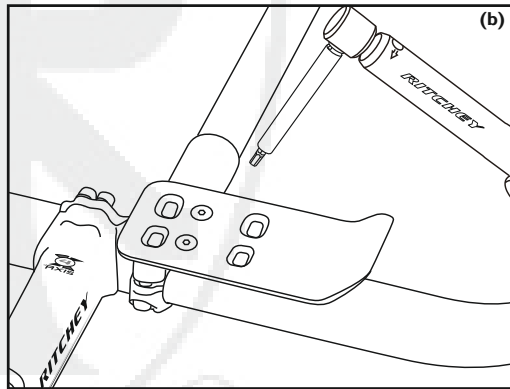

## Grips and Bar Tape

Grips and bar tapes not only provide comfort, but also have a very important secondary function: they ensure that your hands' movements communicate clearly with the steering components!

Make sure your set of grips and the bar tape are in good, functional condition. Replace worn through or extremely dirty grips and bar tapes immediately.

### Installing the Grips

For a reliable fit without play RITCHEY grips must be mounted on handlebars that are free of oil and grease.

- 1) Grips with bolt locking can be slid easily on the handlebars. Verify that the clamping mechanism is at the end of the handlebars. Slide the grip into the correct position on the handlebars and tighten the bolts to ensure a tight fit of the grip. Never exceed the maximum torque value of 3 Nm (d).
- 2) All other RITCHEY grips adhere to the handlebars due to friction between bars and grip. The easiest way to mount the grips is with compressed air. Inflate the grips with air and slide them onto the handlebars. If you don't have compressed air, please contact your RITCHEY dealer to perform this job for you.

We discourage the use of slip agents, such as hairspray etc., as they can cause the grips to loosen during use.

All types of grips that are designed with open ends should be fitted with the enclosed plugs (into the ends of the handlebars). This will avoid or at least reduce potential damage to the handlebars and, more importantly, injuries in the case of a crash.

 Make sure the handlebars are free of lubricants and do not use chemical fluids to mount the grips!

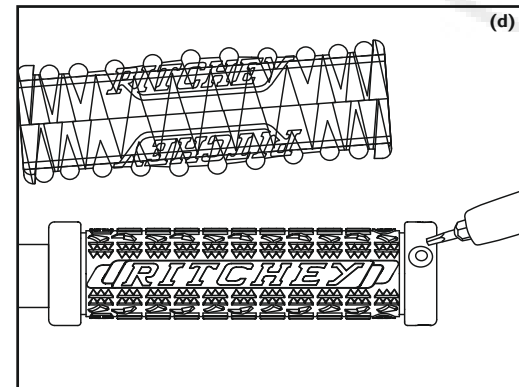

## Wrapping the Bar Tape

Clean the handlebars of any dirt, adhesive residues or grease.

Start wrapping the bar at the bottom, i.e. at the open end of the drop. The first wrap around the bar should be positioned that half of the tape is overlapping the end of the bar (e).

Proceed inward/upward with the tape diagonal and partly overlapping the previous wrap, and so on. Hold the tape under tension during the complete wrapping process and remove the paper backing from the adhesive as you go.

Position a short piece of bar tape on the rear side of the brake lever and over its clamp around the bar so you will not have an “unwrapped area” as you wrap past the lever. Continue wrapping the tape until you reach the bulge/clamp area. Finish by taping the final wrap of the bar tape with insulating tape.

Tuck the overlapping bar tape you left at the beginning into the open end of the bar and insert a plug. Repeat this process on the other side.

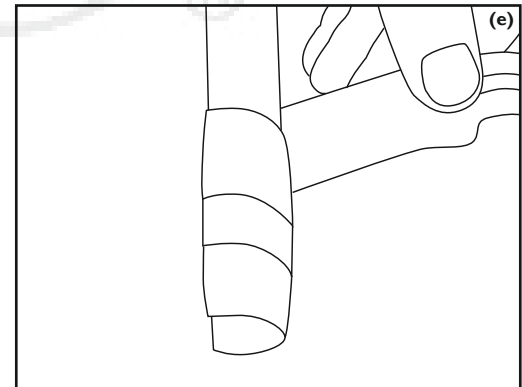

## Warranty Terms

Under European consumer law, the purchaser has full statutory warranty rights within the first two years from date of purchase. In North America, these rights apply to the first year from the date of purchase. According to these laws, your dealer is responsible for ensuring the product is free of defects that could cause premature wear from normal use.



The two year warranty law is only valid in countries where European (EU) regulations apply! Please ask your bicycle dealer about the regulations in your country.

Warranty claims will only be accepted, if the bicycle has been used solely for its intended purpose (see section, “**Before Your First Ride**”).

It does not cover damage resulting from wear (worn through bar tapes and grips), neglect (insufficient care and maintenance), accidents, overstress caused by overloading, incorrect installation, improper treatment or as a result of changes to the components.

Be sure to strictly follow all assembly instructions in this manual as well as all additional instructions provided by the manufacturers of products used in conjunction with RITCHEY products, especially torque values and the prescribed maintenance instructions. Observe all user manuals that may be enclosed with RITCHEY products with regard to behavioral procedures and control procedures that are mentioned in this manual. But also observe any other manuals that may be enclosed with RITCHEY products. Keep the user manuals of all safety-relevant components (handlebars, bar ends, etc.) for your records and future reference.

Your direct contact with regard to all issues outlined in this manual and corresponding instructions is your local RITCHEY dealer, who is qualified to answer your questions. To handle your claim you need to present your receipt.

**In the event of a defect or if you have a warranty issue, please contact the dealer who sold you the bicycle component in question.** RITCHEY has exclusive agreements with all authorized dealers to handle potential warranty claims. If you purchase a RITCHEY product from an unauthorized RITCHEY dealer, e.g. from an internet auction site, the warranty granted by RITCHEY becomes void, so you must seek resolution with the reseller who sold you the product.

## A Note on Wear

Bicycle components are subject to wear due to normal and proper use. The rate of wear will depend on care and maintenance, the bicycle usage and the environmental conditions, such as rain, mud, dust, and sand. Some components require regular care and maintenance, but despite the best maintenance program, all components will eventually reach the end of their service life, depending on conditions and intensity of use.

The following RITCHEY components are especially subject to wear due to the nature of their intended use and not covered for wear under this warranty:

Grips and bar tape that are subject to compression, abrasion and contamination.

## Manufacturer's Guarantee

RITCHEY products have been developed and manufactured with great care and have gone through numerous testing controls. Our products are examined as part of our internal quality control process to meet strict standards as well as by external, independent test laboratories.

For the EU market we grant, independent of legal regulation, a voluntary guarantee that your RITCHEY product is free of manufacturing and processing defects for two years from the date of purchase.

For the North American market we grant, independent of legal regulation, a voluntary guarantee, that your RITCHEY product is free of manufacturing and processing defects for one year from date of purchase. (Exception: grips and bar tape, as above described).

The manufacturer's guarantee only applies to claims made by the initial buyer, who must present the purchase receipt with date of purchase, dealer address and model number. Guarantee claims will only be accepted, if the bicycle has been used in accordance with the intended use of RITCHEY products.

This guarantee does not cover damage resulting from:

- wear
- neglect (insufficient care and maintenance)
- accidents
- overstress caused by overloading
- incorrect installation or improper treatment
- changes or modifications to the component (e.g.: cutting the handlebars).



The instructions of this and all other RITCHEY manuals are drawn up carefully to maximize the service life of RITCHEY products. Any guarantee is void, if installation instructions are ignored and/or if regular inspection and maintenance intervals are not observed.

In the event of a warranty claim, RITCHEY reserves the right to provide all or part of the current successor model in an available colour or if such part is not available, a higher grade model to remedy the claim. The guarantee does not cover assembly, refitting costs or any new accessories that may be required (e.g. different dimension parts).

The guarantee does not cover labour and transport costs, nor does it cover follow-up costs resulting from defects.

**Your direct contact for any issue is your RITCHEY dealer who is authorized to respond to your inquiries.**

RITCHEY International  
Via Cantonale 2  
CH- 6916 Grancia-Lugano

European Authorized Representative  
Obelis s.a  
Bd. Général Wahis 53  
1030 Brussels, BELGIUM

RITCHEY Corporate HQ's  
620 Spice Island Drive  
Sparks, NV 89431

RITCHEY Design Inc.  
Sales & Warranty Office  
575 Old County Road  
San Carlos, CA 94070

RITCHEY Design Inc. Taiwan Branch  
22-1, #123 Chungang Rd. Sec 3  
Taichung 407  
Taiwan R.O.C.

In case of inquiries, contact your national distributor at [www.ritcheylogic.com](http://www.ritcheylogic.com).

Technical details in the text and illustrations of this manual are subject to change.

© No part of this publication may be reprinted, copied or transmitted by hand or with mechanical or electronic systems or used for an another business purpose without prior written permission.

**Concept and text:**

Zedler – Institut für Fahrradtechnik und -Sicherheit GmbH  
[www.zedler.de](http://www.zedler.de)  
Edition 4, October 2012