

Signum SG1X TG RGB

Accessories / Dołączone akcesoria

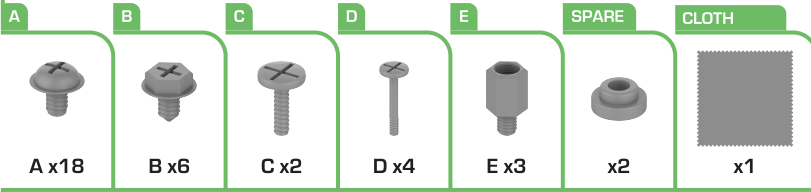

4x Corona HP RGB 120
(pre installed)
4x Corona HP RGB 120
(zamontowane)

ZIP TIE

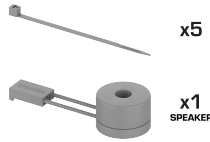

x5

x1
SPEAKER

NANO RESET RGB

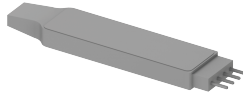

PANEL I/O

1. USB ports/
Wejścia USB
2. Microphone port/
Wtyczka mikrofonu
3. Headphone port/
Wtyczka słuchawek
4. HDD, SSD LED/
Dioda HDD, SSD
5. Reset button/
Przycisk resetu
6. Power button/
Przycisk zasilania

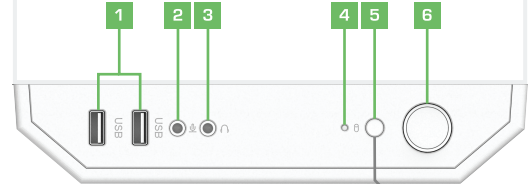

1. Overview / Przegląd

REAR / TYŁ



120 FAN
120 RAD

TOP FILTER / FILTR GÓRNY



PSU FILTER / FILTR ZASILACZA



CPU MAX:
161MM



GPU MAX:
325MM



PSU MAX:
160/280MM

FRONT FILTERS / FILTRY PRZEDNIE

TOP / GÓRA

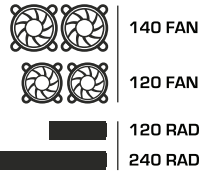

140 FAN

120 FAN

120 RAD

240 RAD

PSU CHAMBER / KOMORA ZASILACZA



120 FAN

FRONT / PRZÓD

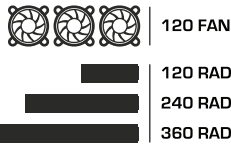

120 FAN

120 RAD

240 RAD

360 RAD



2. Panel removal / Zdejmowanie paneli



RGB and FAN Splitter/ Rozgałęziacz łączący RGB oraz zasilania wentylatorów

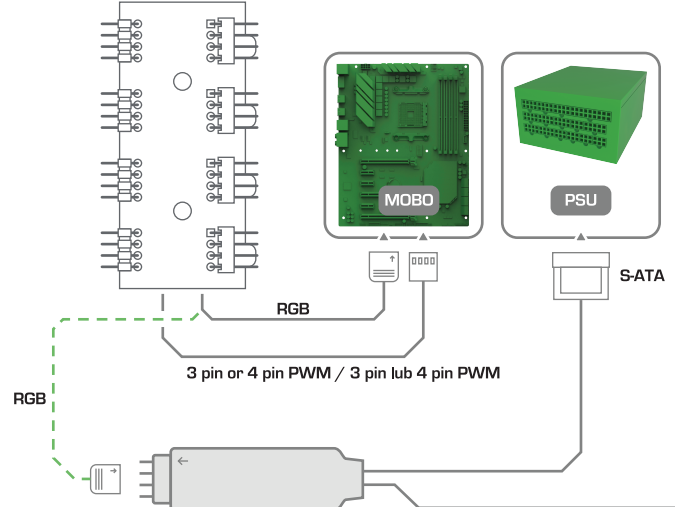

i EN: If motherboard without RGB connector use Nano Reset RGB controller/
PL: Jeśli płyta główna nie posiada złącza RGB, podłącz do kontrolera Nano Reset RGB

3. Hardware installation / Montaż sprzętu

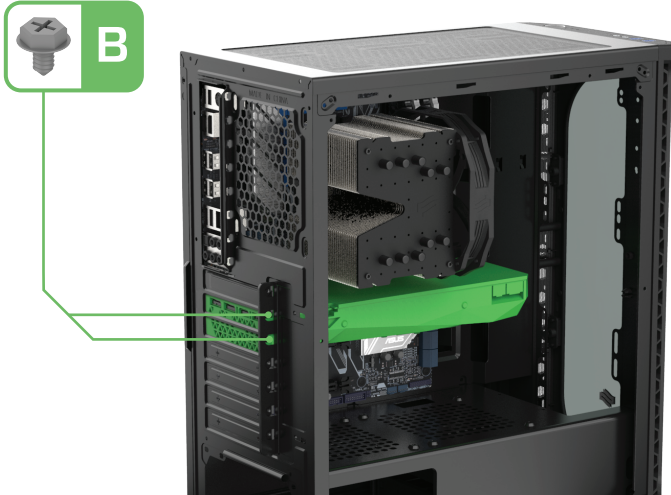
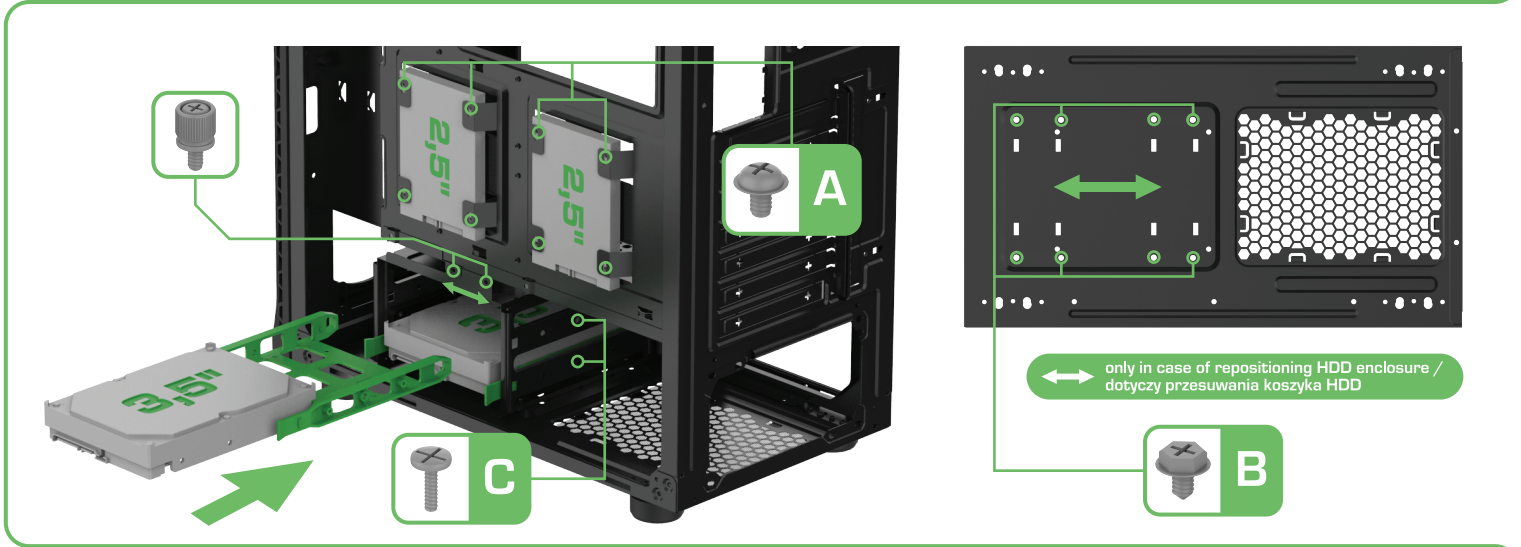
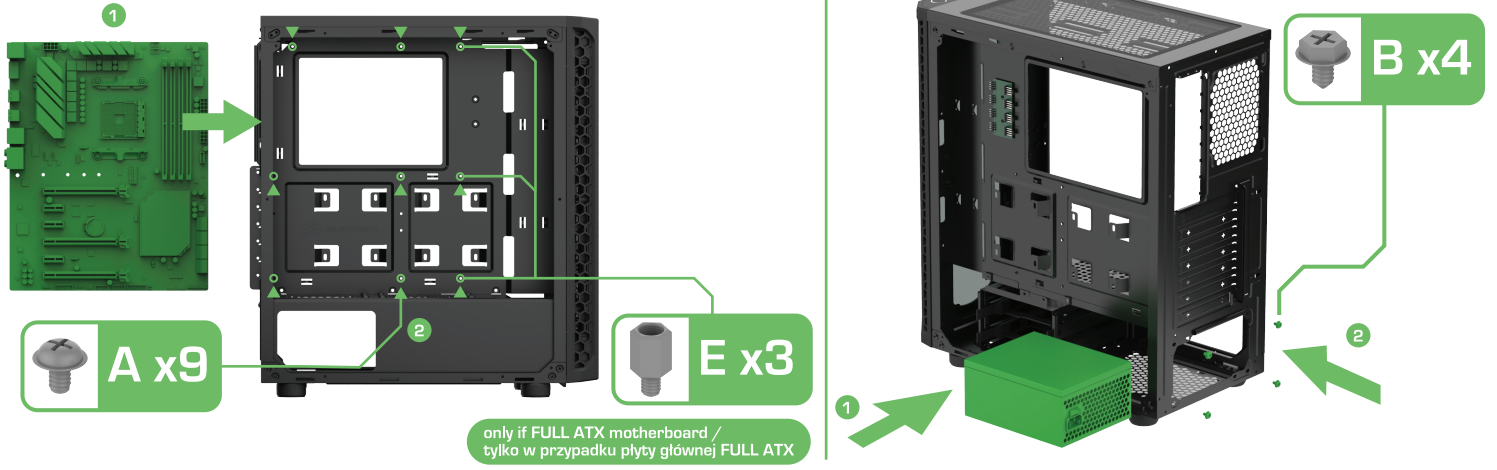

4. Front panel removal / Zdejmowanie panela przedniego



5. Dust filters / Filtry przeciwkurzowe

