

---

# Incredible Immersion with Ultra-Narrow Bezel

## VL5F Series

The VL5F series provides all-encompassing screen immersion thanks to its ultra-narrow 3.5 mm bezel-to-bezel, while its outstanding IPS panel delivers a clear image from any angle. With its extremely attractive and highly functional design, it can be used to deliver advertising and information in a variety of business environments.

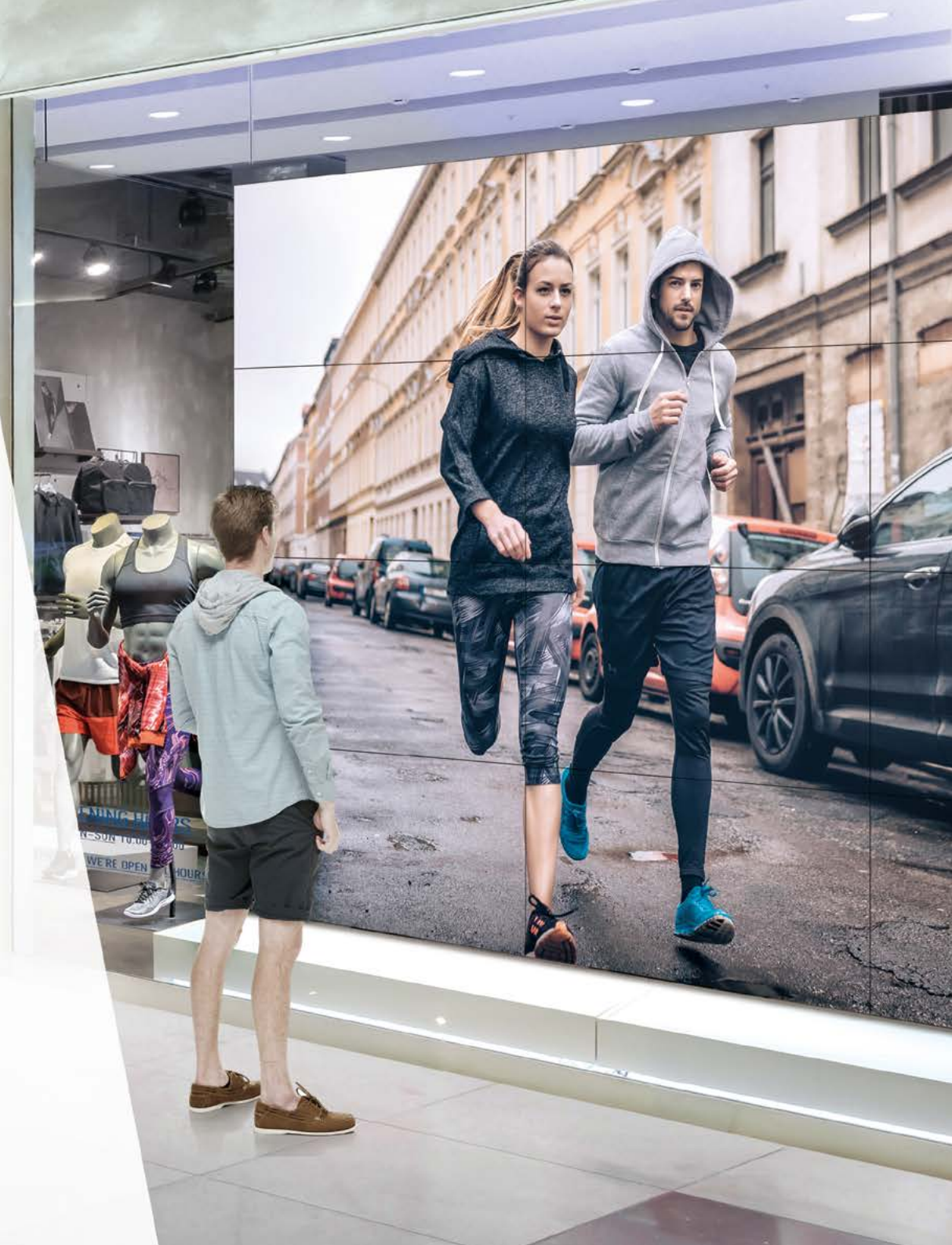

# Incredible Immersion with Ultra-Narrow Bezel

## VL5F Series

### Achieving Incredible Immersion

#### Seamless Large Screens with Ultra-Narrow Bezel

The ultra-narrow bezel creates a visually stunning digital wall to effectively deliver dynamic content and immerse the viewers. The large screen it generates is enough to captivate the attention of passersby.



#### Image Gap Reduction

The VL5F series includes an image improvement algorithm that can reduce image gaps among tiled displays when playing back videos. Objects located on the bezel boundaries are adjusted for a seamless viewing experience.

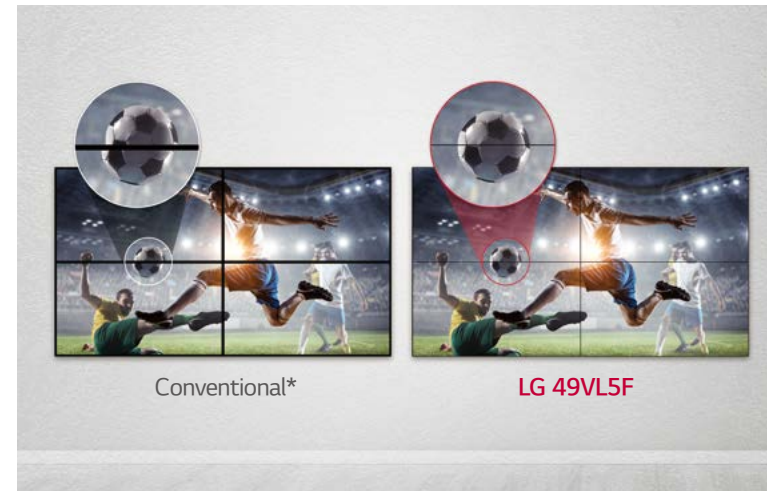

\* The "Conventional" refers to displays which do not include an image improvement algorithm.



# Incredible Immersion with Ultra-Narrow Bezel

## VL5F Series

### Vivid and Dynamic Picture Quality

#### Higher Viewing Angle

Large screens are usually positioned higher than human-eye level, making uniform picture quality essential for video walls. The viewing angle of the VL5F series is high enough to display vivid colors throughout the screen with no distortion.



45°\* High Viewing Angle

#### Wider Viewing Angle

It is well known that LG IPS panel technology enables better control of liquid crystals, which in turn allows the screen to be viewed from virtually any angle. Because of this, the VL5F series captures the attention of and captivates more viewers with lifelike colors, regardless of their viewing position.



\* Results based on in-house testing. Actual test results may differ depending on environment and measuring equipment.

# Incredible Immersion with Ultra-Narrow Bezel

## VL5F Series

### User Convenience

#### Easy Color Adjustment

Depending on the content, the color temperature of the display can be easily adjusted in increments of 100K using a remote control.

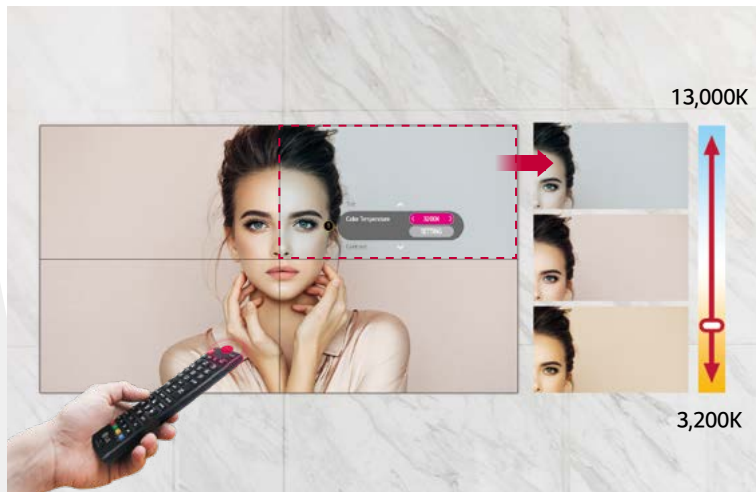

#### Simple White Balance Adjustment

In conventional video walls, white balance was adjustable only in "full-white" mode, but the VL5F series allows you to modify each value of grey scale to achieve more detailed and precise white balance adjustment.



# Incredible Immersion with Ultra-Narrow Bezel

## VL5F Series

### User Convenience

#### User-Friendly Menu Structure

The menu structure has been optimized for commercial use. It simplifies approach flows and groups similar functions together, adopting a more intuitive GUI for ease of use. This way, users can avoid having to do trial-and-error when exploring desired functions and managing displays.

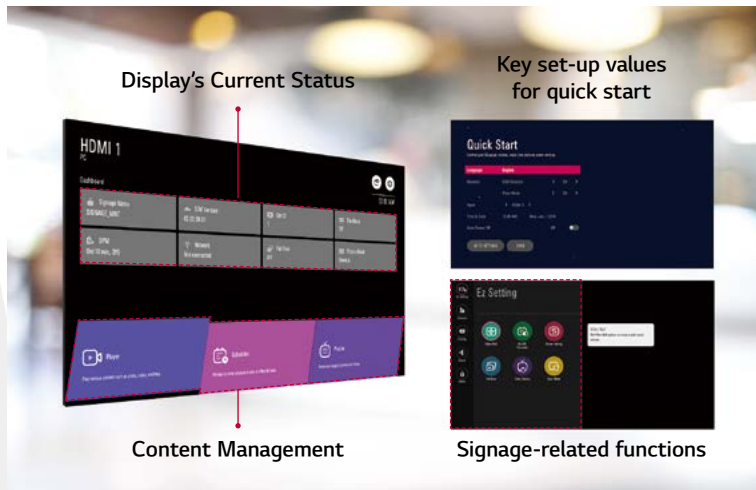

#### Intuitive GUI

The GUI(Graphic User Interface) is carefully designed with a four-way navigation remote control that lets users easily switch to other settings. Also, it adopts a larger font for better visibility, which is necessary when users want to control displays from relatively far distances.

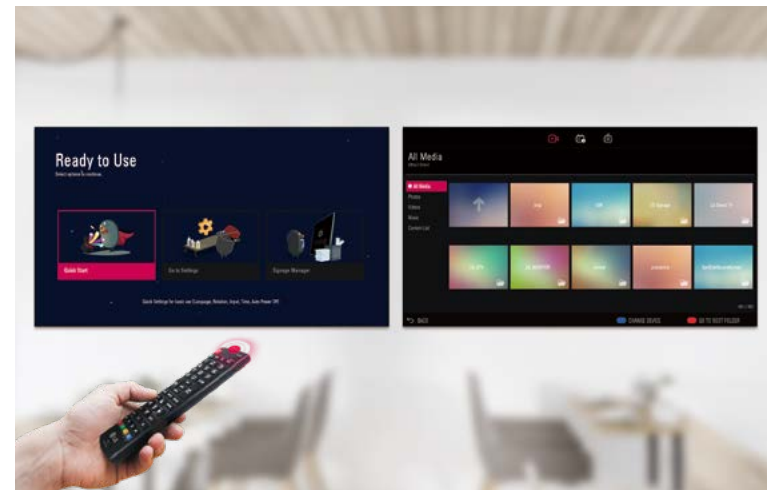

## Dimension (unit: mm)

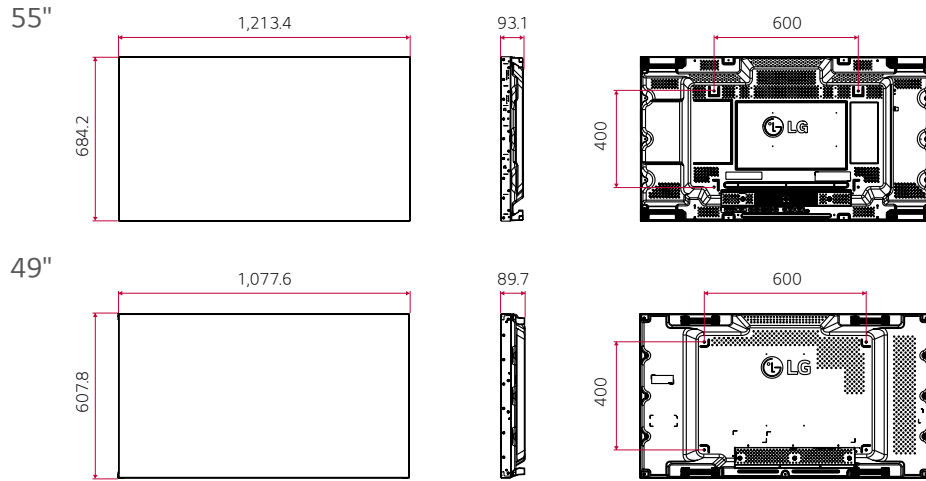

## Connectivity

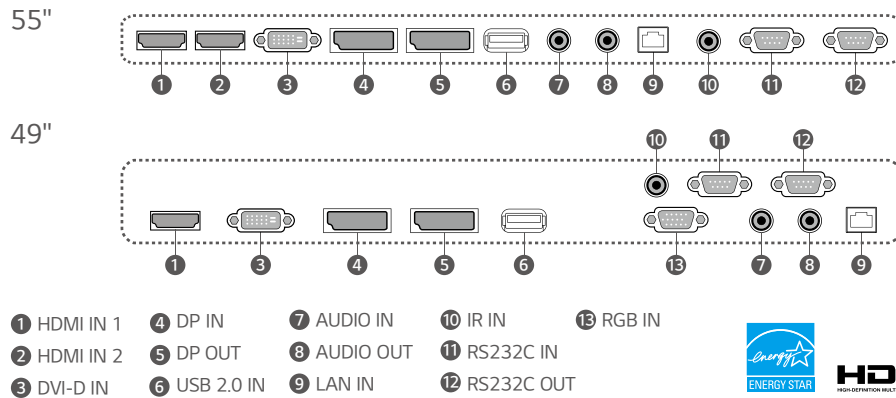

## Specifications

	55VL5F	49VL5F	
<b>PANEL</b>	Screen Size	55"	49"
	Panel Technology	IPS	IPS
	Aspect Ratio	16 : 9	16 : 9
	Native Resolution	1,920 x 1,080 (FHD)	1,920 x 1,080 (FHD)
	Brightness (Typ.)	500 cd/m <sup>2</sup>	450 cd/m <sup>2</sup>
	Contrast Ratio	1,200:1	1,300:1
	Dynamic CR	500,000 : 1	500,000:1
	Viewing Angle (H x V)	178 x 178	178 x 178
	Response Time	8 ms (G to G)	8 ms (G to G)
	Surface Treatment	3%	3%
Life Time (Typ.)	50,000 Hrs	50,000 Hrs	
Operation Hours	24 Hrs	24 Hrs	
Orientation	Landscape & Portrait	Landscape & Portrait	
<b>CONNECTIVITY</b>	Input	HDMI(2), DP, DVI-D, Audio, USB	HDMI, DP, DVI-D, RGB, Audio, USB
	Output	DP, Audio	DP, Audio
<b>EXTERNAL CONTROL</b>	External Control	RS232C In/out, RJ45(LAN) In, IR In	RS232C In/out, RJ45 (LAN) In, IR In
	Bezel Color	Black	Black
<b>MECHANICAL SPECIFICATION</b>	Bezel Width	2.25 mm (T/L) / 1.25 mm(B/R)	2.3 mm (T/L), 1.2 mm (B/R)
	Monitor Dimension (W x H x D)	1,213.4 x 684.2 x 93.1 mm	1,077.6 x 607.8 x 89.7 mm
	Weight (Head)	23.2kg	17.8 kg
	Carton Dimensions (W x H x D)	1,337 x 828 x 239 mm	1,214 x 778 x 263 mm
	Packed Weight	30.5kg	22.8 kg
	Handle	Yes	Yes
VESA™ Standard Mount Interface	600 x 400 mm	600 x 400 mm	
<b>KEY FEATURE</b>	Temperature Sensor, Tile Mode (Up to 15x15), Natural Mode @Tile Mode, ISM Method, DPM Wake Up, Smart Energy Saving, File Play with USB, USB Cloning, Contents Scheduling (USB), Calibration Mode, PM Mode, Firmware Update (LAN), HDMI-CEC <sup>1)</sup> , No Signal Image (Up to 5MB), Wake on LAN, Failover, OPS Power Control, Scan Inversion (with Pivot Mode)		
<b>ENVIRONMENT CONDITIONS</b>	Operation Temperature	0°C to 40°C	0°C to 40°C
	Operation Humidity	10% to 80%	10% to 80%
<b>POWER</b>	Power Supply	100-240V~, 50/60Hz	100-240V~, 50/60Hz
	Power Type	Built-In Power	Built-In Power
	Power Typ./Max. Consumption Smart Energy Saving	130 W / 150 W 62 W	90 W / 110 W 55 W
<b>CERTIFICATION</b>	Safety	IEC 60950-1 / EN 60950-1 / UL 60950-1	IEC 60950-1 / EN 60950-1 / UL 60950-1
	EMC	FCC Class "A" / CE / KC	FCC Class "A" / CE / KC
<b>MEDIA PLAYER COMPATIBILITY</b>	ErP / Energy Star	NA / Yes (Energy Star 7.0)	N/A / Yes (Energy Star 7.0)
	OPS Type Compatible	No	No
<b>SOFTWARE COMPATIBILITY</b>	External Media Player Attachable	Yes (MP500/MP700)	Yes (MP500/MP700)
	Content Management Software	SuperSign CMS	SuperSign CMS
<b>ACCESSORIES</b>	Control and Monitoring Software	SuperSign Control/Control+	SuperSign Control/Control+
	Basic	Remote Controller, Power Cord, RS232C Cable, DP Cable, IR Receiver, Guide Bracket, Screws, Manual	
Optional	Wall Mount (Landscape: WM-L640V, Portrait: WM-P640V)		

1) Compatibility may differ by equipment



Download  
LG C-Display+  
Mobile App

Google Play Store

- www.lg.com/b2b
- www.youtube.com/c/LGCommercialDisplay
- www.facebook.com/LGInformationDisplay
- www.linkedin.com/company/LGInformationDisplay

LG may make changes to specifications and product descriptions without notice.  
Copyright © 2019 LG Electronics Inc. All rights reserved. "LG Life's Good" is a registered trademark of LG Corp.  
The names of products and brands mentioned here may be the trademarks of their respective owners.

