

# Unpacking

Thank you for buying the MSI® **H270M BAZOOKA/ B250M BAZOOKA** motherboard. Check to make sure your motherboard box contains the following items. If something is missing, contact your dealer as soon as possible.

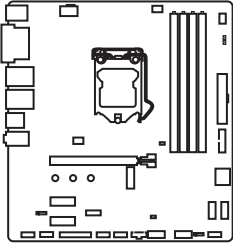

Motherboard

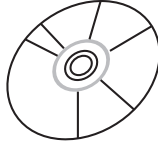

Drivers & Utilities  
Disc



Motherboard User  
Guide



I/O Shield

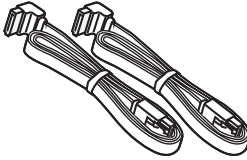

SATA Cable x2

## Safety Information

- The components included in this package are prone to damage from electrostatic discharge (ESD). Please adhere to the following instructions to ensure successful computer assembly.
- Ensure that all components are securely connected. Loose connections may cause the computer to not recognize a component or fail to start.
- Hold the motherboard by the edges to avoid touching sensitive components.
- It is recommended to wear an electrostatic discharge (ESD) wrist strap when handling the motherboard to prevent electrostatic damage. If an ESD wrist strap is not available, discharge yourself of static electricity by touching another metal object before handling the motherboard.
- Store the motherboard in an electrostatic shielding container or on an anti-static pad whenever the motherboard is not installed.
- Before turning on the computer, ensure that there are no loose screws or metal components on the motherboard or anywhere within the computer case.
- Do not boot the computer before installation is completed. This could cause permanent damage to the components as well as injury to the user.
- If you need help during any installation step, please consult a certified computer technician.
- Always turn off the power supply and unplug the power cord from the power outlet before installing or removing any computer component.
- Keep this user guide for future reference.
- Keep this motherboard away from humidity.
- Make sure that your electrical outlet provides the same voltage as is indicated on the PSU, before connecting the PSU to the electrical outlet.
- Place the power cord such a way that people can not step on it. Do not place anything over the power cord.
- All cautions and warnings on the motherboard should be noted.
- If any of the following situations arises, get the motherboard checked by service personnel:
  - Liquid has penetrated into the computer.
  - The motherboard has been exposed to moisture.
  - The motherboard does not work well or you can not get it work according to user guide.
  - The motherboard has been dropped and damaged.
  - The motherboard has obvious sign of breakage.
- Do not leave this motherboard in an environment above 60°C (140°F), it may damage the motherboard.

# Quick Start

## Preparing Tools and Components

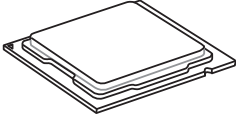

Intel® LGA 1151 CPU

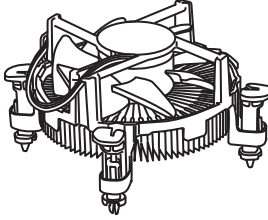

CPU Fan

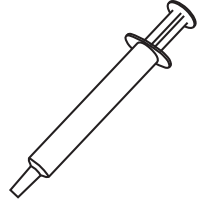

Thermal Paste

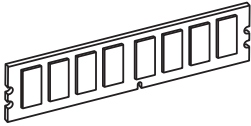

DDR4 Memory

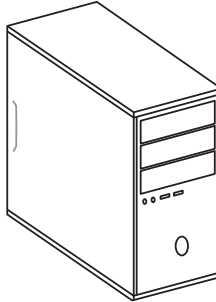

Chassis

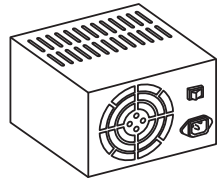

Power Supply Unit



SATA DVD Drive

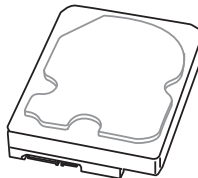

SATA Hard Disk Drive

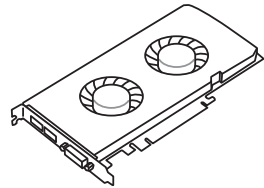

Graphics Card

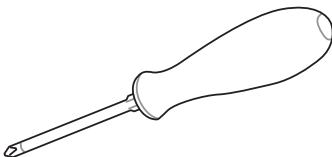

Phillips Screwdriver

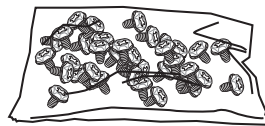

A Package of Screws

# Installing a Processor



<http://youtu.be/bf5La099url>

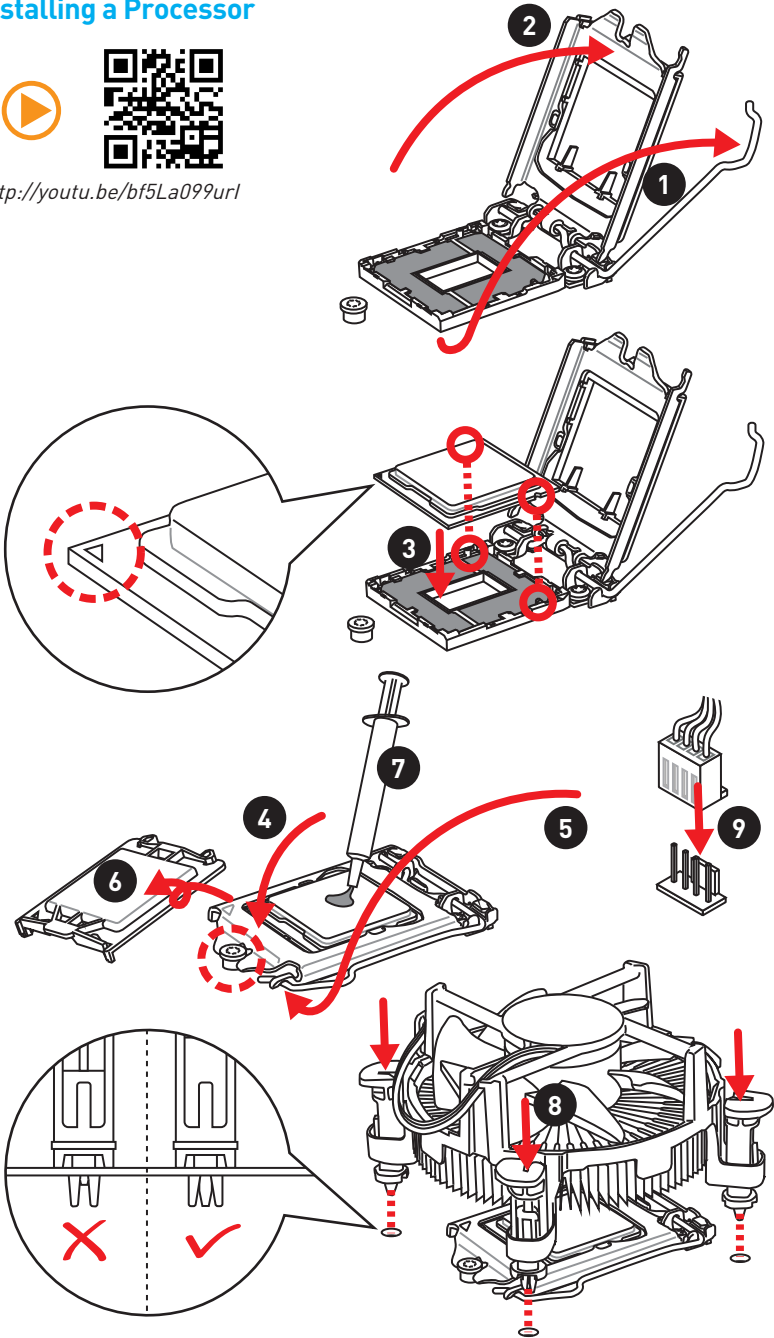

# Installing DDR4 memory



<http://youtu.be/T03aDrJPYQs>

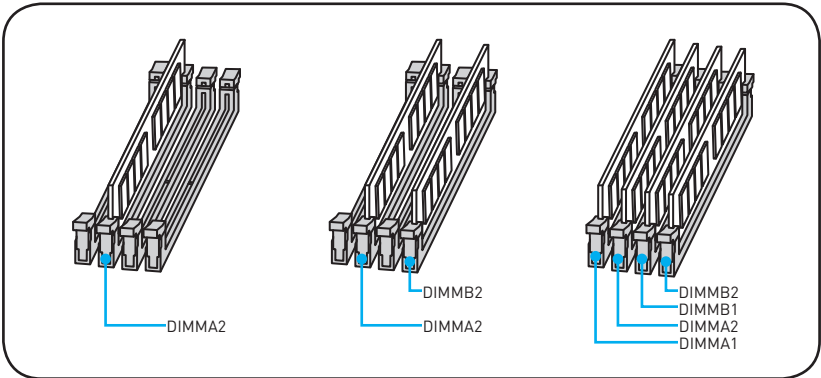
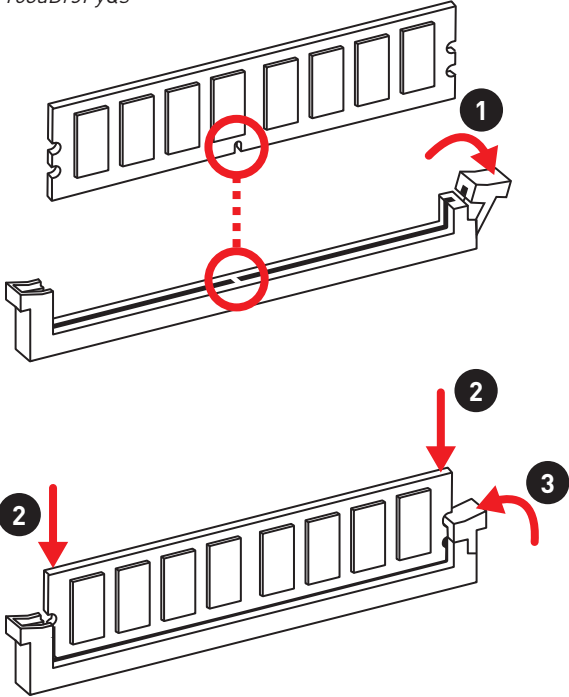

# Connecting the Front Panel Header



<http://youtu.be/DPELIdVNZUI>

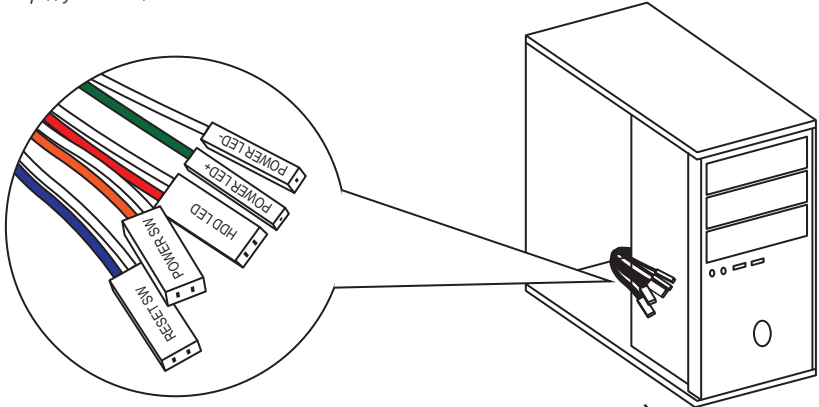

<p>JFP1</p>		1	HDD LED +	2	Power LED +
		3	HDD LED -	4	Power LED -
		5	Reset Switch	6	Power Switch
		7	Reset Switch	8	Power Switch
		9	Reserved	10	No Pin

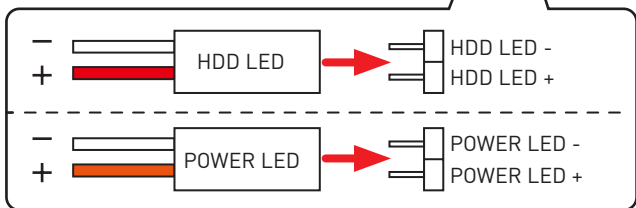
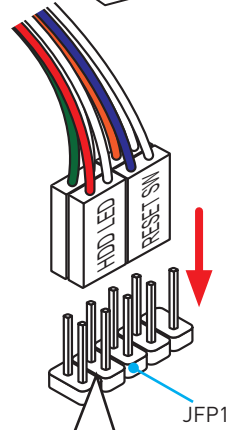

# Installing the Motherboard

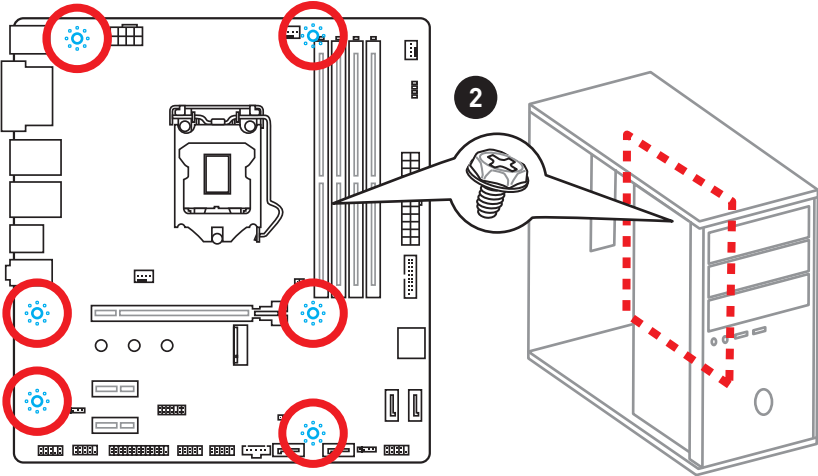
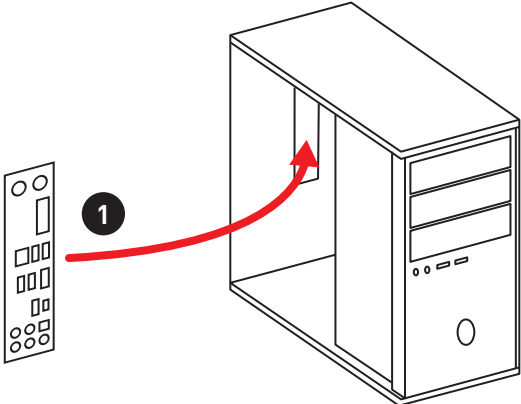

# Installing SATA Drives



<http://youtu.be/RZsMpqxythc>

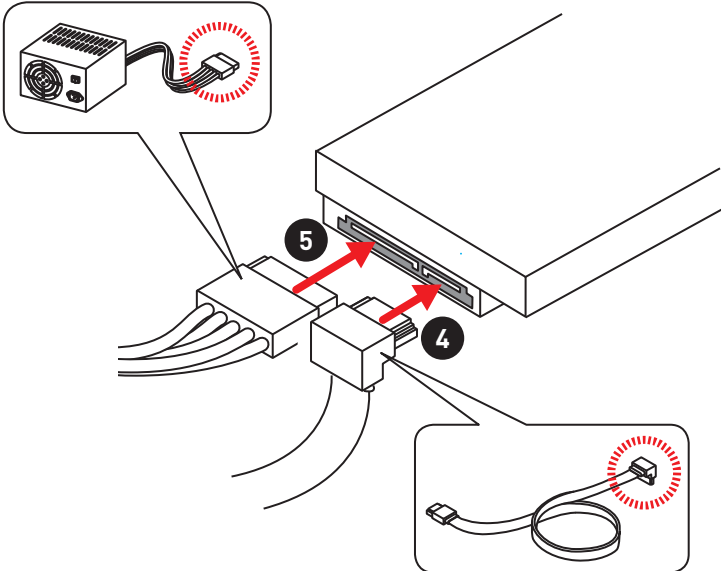
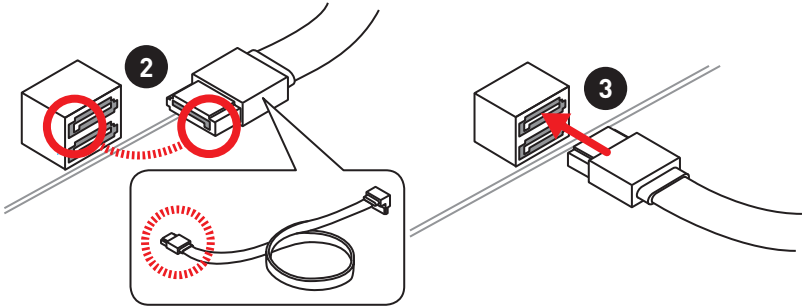
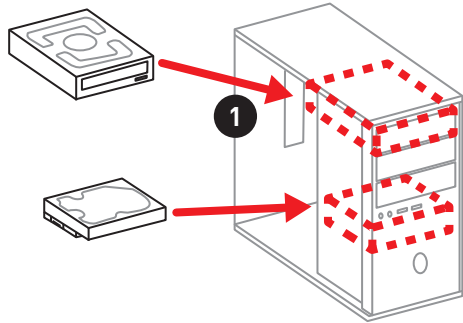



## Installing a Graphics Card



[http://youtu.be/mG0GZpr9w\\_A](http://youtu.be/mG0GZpr9w_A)

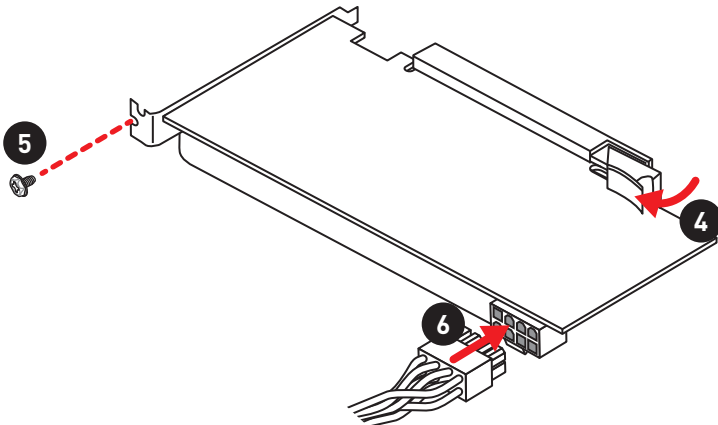
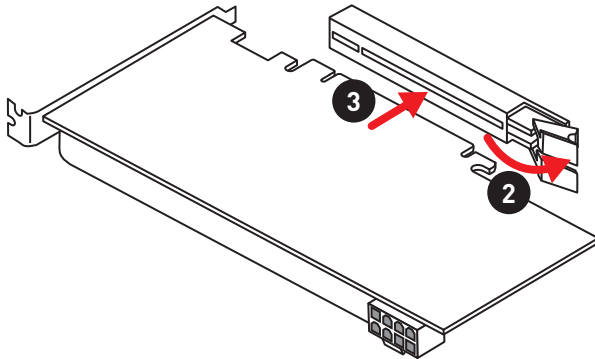
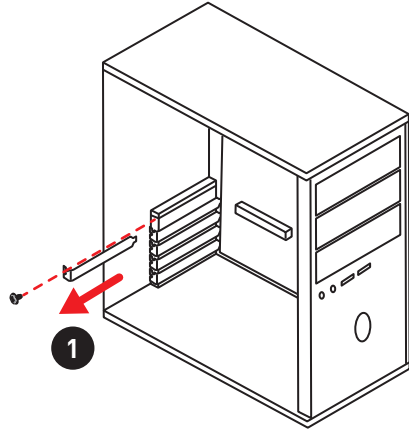

# Connecting Peripheral Devices

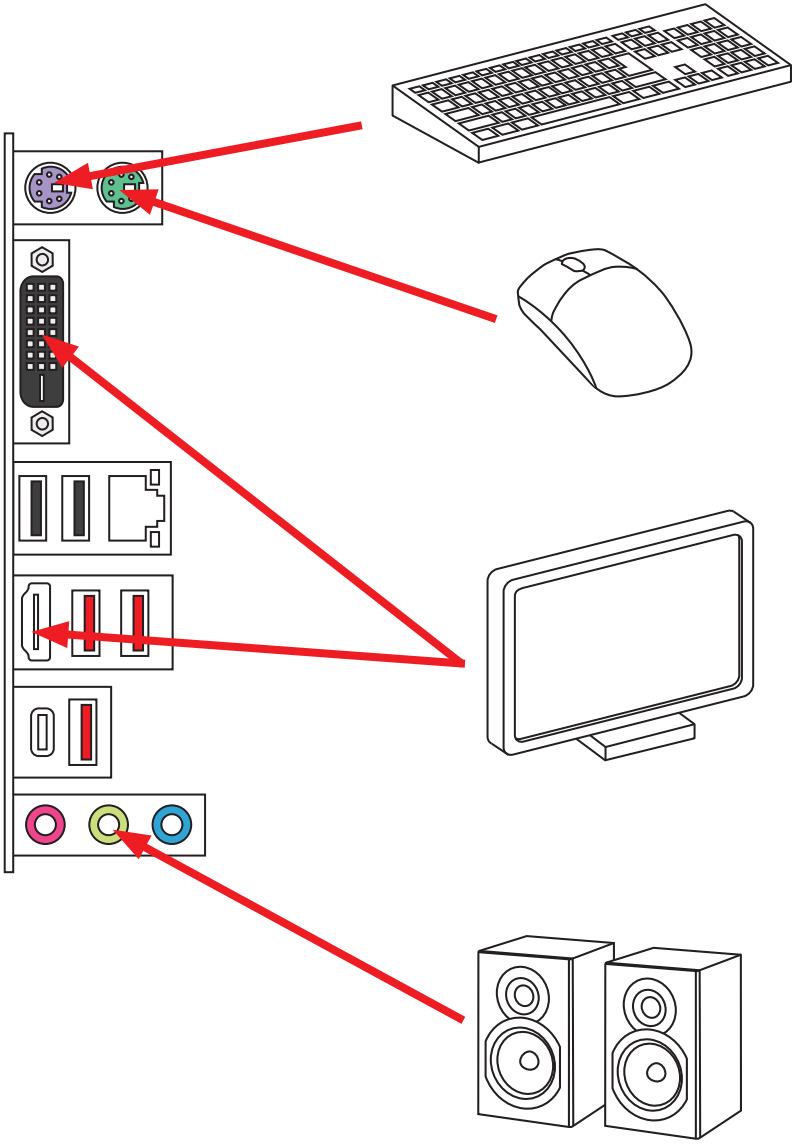

# Connecting the Power Connectors



[http://youtu.be/gkDYyR\\_8314](http://youtu.be/gkDYyR_8314)

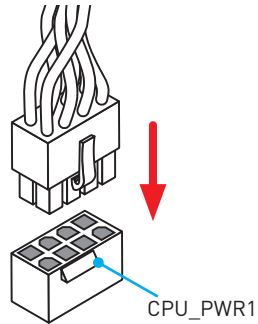
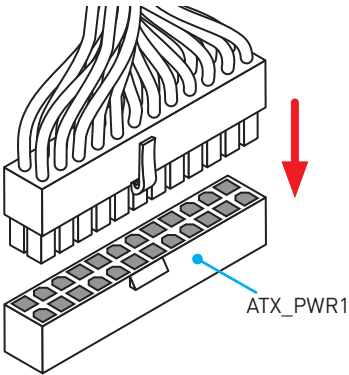
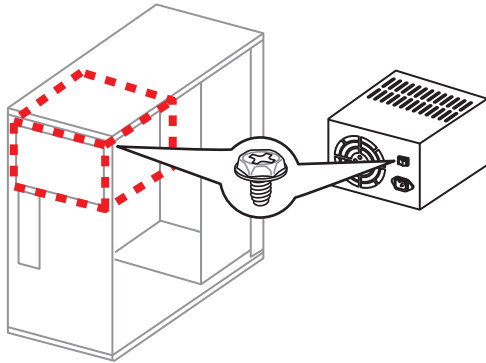

# Power On

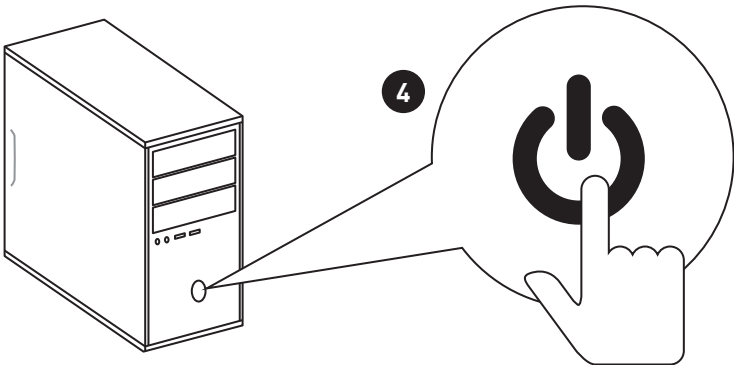
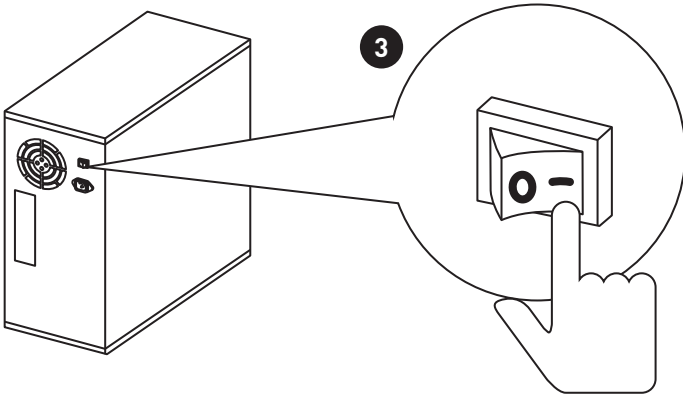
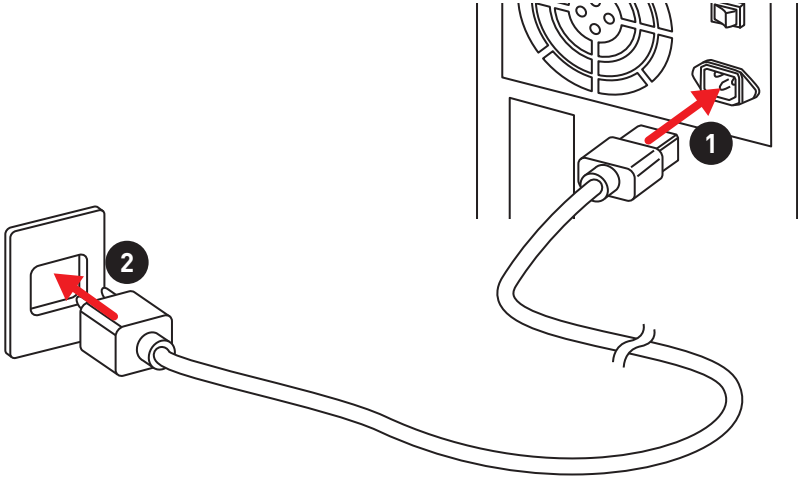

# Contents

<b>Unpacking .....</b>	<b>1</b>
<b>Safety Information .....</b>	<b>2</b>
<b>Quick Start .....</b>	<b>3</b>
Preparing Tools and Components .....	3
Installing a Processor .....	4
Installing DDR4 memory .....	5
Connecting the Front Panel Header .....	6
Installing the Motherboard .....	7
Installing SATA Drives .....	8
Installing a Graphics Card .....	9
Connecting Peripheral Devices .....	10
Connecting the Power Connectors .....	11
Power On .....	12
<b>Specifications .....</b>	<b>15</b>
<b>Block Diagram .....</b>	<b>19</b>
<b>Rear I/O Panel .....</b>	<b>20</b>
LAN Port LED Status Table .....	20
Realtek HD Audio Manager .....	20
<b>Overview of Components .....</b>	<b>22</b>
CPU Socket .....	24
DIMM Slots .....	25
PCI_E1~3: PCIe Expansion Slots .....	26
SATA1~6: SATA 6Gb/s Connectors .....	26
M2_1: M.2 Slot (Key M) .....	27
JFP1, JFP2: Front Panel Connectors .....	28
JAUD1: Front Audio Connector .....	28
JCOM1: Serial Port Connector .....	28
CPU_PWR1, ATX_PWR1: Power Connectors .....	29
JUSB2~3: USB 2.0 Connectors .....	30
JUSB1: USB 3.1 Gen1 Connectors .....	30
CPU_FAN1~2,SYS_FAN1~4: Fan Connectors .....	31
JC11: Chassis Intrusion Connector .....	32
JTPM1: TPM Module Connector .....	32
JLED1: RGB LED connector .....	33
JLPT1: Parallel Port Connector .....	33
JBAT1: Clear CMOS (Reset BIOS) Jumper .....	34

EZ Debug LED.....	34
<b>BIOS Setup.....</b>	<b>35</b>
Entering BIOS Setup.....	35
Resetting BIOS.....	36
Updating BIOS.....	36
System Status Menu.....	37
Advanced Menu.....	38
Overclocking Menu.....	45
M-Flash Menu.....	51
Security Menu.....	52
Boot Menu.....	54
Save & Exit Menu.....	55
<b>Software Description.....</b>	<b>56</b>
Installing Windows® 7/ 8.1/ 10.....	56
Installing Drivers.....	56
Installing Utilities.....	56
COMMAND CENTER.....	57
LIVE UPDATE 6.....	61
GAMING APP.....	63
RAMDISK.....	67
GAMING LAN MANAGER.....	68
DRAGON EYE.....	70
Intel® Extreme Tuning Utility.....	71
SteelSeries Engine 3.....	72
CPU-Z.....	74
<b>RAID Configuration (optional).....</b>	<b>75</b>
Using Intel® Rapid Storage Technology Option ROM.....	75
Degraded RAID Array.....	78
<b>Troubleshooting.....</b>	<b>80</b>
<b>Regulatory Notices.....</b>	<b>81</b>

# Specifications

CPU	Supports 6th/7th Gen Intel® Core™ i3/i5/i7 processors, and Intel® Pentium® and Celeron® processors for Socket LGA1151
Chipset	Intel® H270/ B250 Chipset
Memory	<ul style="list-style-type: none"> <li>• 4x DDR4 memory slots, support up to 64GB             <ul style="list-style-type: none"> <li>▪ 7th Gen processors support DDR4 2400/ 2133 MHz*</li> <li>▪ 6th Gen processors support DDR4 2133 MHz*</li> </ul> </li> <li>• Dual channel memory architecture</li> <li>• Supports Intel® Extreme Memory Profile (XMP)**</li> </ul> <p>* Please refer <a href="http://www.msi.com">www.msi.com</a> for more information on compatible memory.            ** DDR4 memory modules can only run at maximum of 2400 MHz for 7th Gen processors and 2133 MHz for 6th Gen processors on XMP mode.</p>
Expansion Slots	<ul style="list-style-type: none"> <li>• 1x PCIe 3.0 x16 slot (supports x16 mode)</li> <li>• 2x PCIe 3.0 x1 slots</li> </ul>
Onboard Graphics	<ul style="list-style-type: none"> <li>• 1x HDMI™ port, supports a maximum resolution of 4096x2160@24Hz, 2560x1600@60Hz</li> <li>• 1x DVI-D port, supports a maximum resolution of 1920x1200@60Hz</li> </ul>
Storage	<p>Intel® H270/ B250 Chipset</p> <ul style="list-style-type: none"> <li>• 6x SATA 6Gb/s ports</li> <li>• 1x M.2 slot (Key M)*             <ul style="list-style-type: none"> <li>▪ Supports up to PCIe 3.0 x4 and SATA 6Gb/s</li> <li>▪ Supports 2242/ 2260 /2280 storage devices</li> <li>▪ Intel® Optane™ Memory Ready</li> </ul> </li> <li>• H270 supports RAID 0, RAID1, RAID 5 and RAID 10 for SATA storage devices</li> </ul> <p>* The SATA1 port will be unavailable when an M.2 SATA SSD module has been installed in the M.2 slot.</p>
USB	<p>Intel® H270/ B250 Chipset</p> <ul style="list-style-type: none"> <li>• 6x USB 3.1 Gen1 (SuperSpeed USB) ports (3 Type-A &amp; 1 Type-C ports on the back panel, 2 ports available through the internal USB connector)</li> <li>• 6x USB 2.0 (High-speed USB) ports (2 ports on the back panel, 4 ports available through the internal USB connector)</li> </ul>
Audio	<ul style="list-style-type: none"> <li>• Realtek® ALC887 Codec</li> <li>• 7.1-Channel High Definition Audio</li> </ul>
LAN	1x Realtek® 8111H Gigabit LAN controller

Continued on next page

Continued from previous page

<p>Back Panel Connectors</p>	<ul style="list-style-type: none"> <li>• 1x PS/2 keyboard port</li> <li>• 1x PS/2 mouse port</li> <li>• 1x HDMI™ port</li> <li>• 1x DVI-D port</li> <li>• 1x LAN (RJ45) port</li> <li>• 2x USB 2.0 Type-A ports</li> <li>• 3x USB 3.1 Gen1 Type-A ports</li> <li>• 1x USB 3.1 Gen1 Type-C port</li> <li>• 3x audio jacks</li> </ul>
<p>Internal Connectors</p>	<ul style="list-style-type: none"> <li>• 1x 24-pin ATX main power connector</li> <li>• 1x 8-pin ATX 12V power connector</li> <li>• 6x SATA 6Gb/s connectors</li> <li>• 2x USB 2.0 connectors (supports additional 4 USB 2.0 ports)</li> <li>• 1x USB 3.1 Gen1 connector (supports additional 2 USB 3.1 Gen1 ports)</li> <li>• 1x 4-pin CPU fan connector</li> <li>• 2x 4-pin system fan connectors</li> <li>• 1x Front panel audio connector</li> <li>• 2x Front panel connectors</li> <li>• 1x TPM module connector</li> <li>• 1x Chassis Intrusion connector</li> <li>• 1x Serial port connector</li> <li>• 1x Parallel port connector</li> <li>• 1x RGB LED connector</li> <li>• 1x TBT connector</li> <li>• 1x Clear CMOS jumper</li> </ul>
<p>I/O Controller</p>	<p>NUVOTON NCT6795 Controller Chip</p>
<p>Hardware Monitor</p>	<ul style="list-style-type: none"> <li>• CPU/System temperature detection</li> <li>• CPU/System fan speed detection</li> <li>• CPU/System fan speed control</li> </ul>
<p>Form Factor</p>	<ul style="list-style-type: none"> <li>• ATX Form Factor</li> <li>• 9.6 in. x 9.0 in. (24.4 cm x 22.8 cm)</li> </ul>

Continued on next page



Continued from previous page

BIOS Features	<ul style="list-style-type: none"><li>• 1x 64 Mb flash</li><li>• UEFI AMI BIOS</li><li>• ACPI 5.0, PnP 1.0a, SM BIOS 2.8</li><li>• Multi-language</li></ul>
Software	<ul style="list-style-type: none"><li>• Drivers</li><li>• COMMAND CENTER</li><li>• LIVE UPDATE 6</li><li>• FAST BOOT</li><li>• SUPER CHARGER</li><li>• GAMING APP</li><li>• RAMDISK</li><li>• GAMING LAN MANAGER</li><li>• X-BOOST</li><li>• MSI SMART TOOL</li><li>• Intel® Extreme Tuning Utility</li><li>• Norton™ Internet Security Solution</li><li>• Google Chrome™ ,Google Toolbar, Google Drive</li><li>• SteelSeries Engine 3</li><li>• CPU-Z MSI GAMING</li><li>• DRAGON EYE</li></ul>
Arsenal GAMING Features	<ul style="list-style-type: none"><li>• GAMING LAN<ul style="list-style-type: none"><li>▪ GAMING Network Manager power by cFos</li></ul></li><li>• GAMING APP<ul style="list-style-type: none"><li>▪ Gaming Hotkey</li><li>▪ Gaming Mouse Control</li></ul></li><li>• GAMING CERTIFIED</li><li>• WTFast GPN*<ul style="list-style-type: none"><li>▪ 2-Month Premium License</li><li>▪ Multi-Server Network Optimization</li><li>▪ Advanced Lag Spike &amp; Disconnect Reduction</li></ul></li></ul> <p>* This offer is valid for a limited period only, for more information please visit <a href="http://www.msi.com">www.msi.com</a></p>

Continued on next page

Continued from previous page

MSI Exclusive Features	<ul style="list-style-type: none"><li>• CLICK BIOS</li><li>• MILITARY CLASS 5<ul style="list-style-type: none"><li>▪ Military Class Component</li><li>▪ Military Class Stability and Reliability<ul style="list-style-type: none"><li>• ESD Protection</li><li>• EMI Protection</li><li>• Humidity Protection</li><li>• Circuit Protection</li><li>• High Temperature Protection</li><li>• VGA Armor PCIe Slots</li></ul></li></ul></li><li>• COMMAND CENTER<ul style="list-style-type: none"><li>▪ System Monitor</li><li>▪ Smart Fan Control</li></ul></li><li>• RAMDISK</li><li>• LIVE UPDATE 6</li><li>• GAMING DNA</li><li>• CPU-Z</li></ul>
Specification Highlights	<ul style="list-style-type: none"><li>• PCI Express 3.0 Support</li><li>• SATA Express Support</li><li>• NVMe / AHCI Driver Support</li></ul>

# Block Diagram

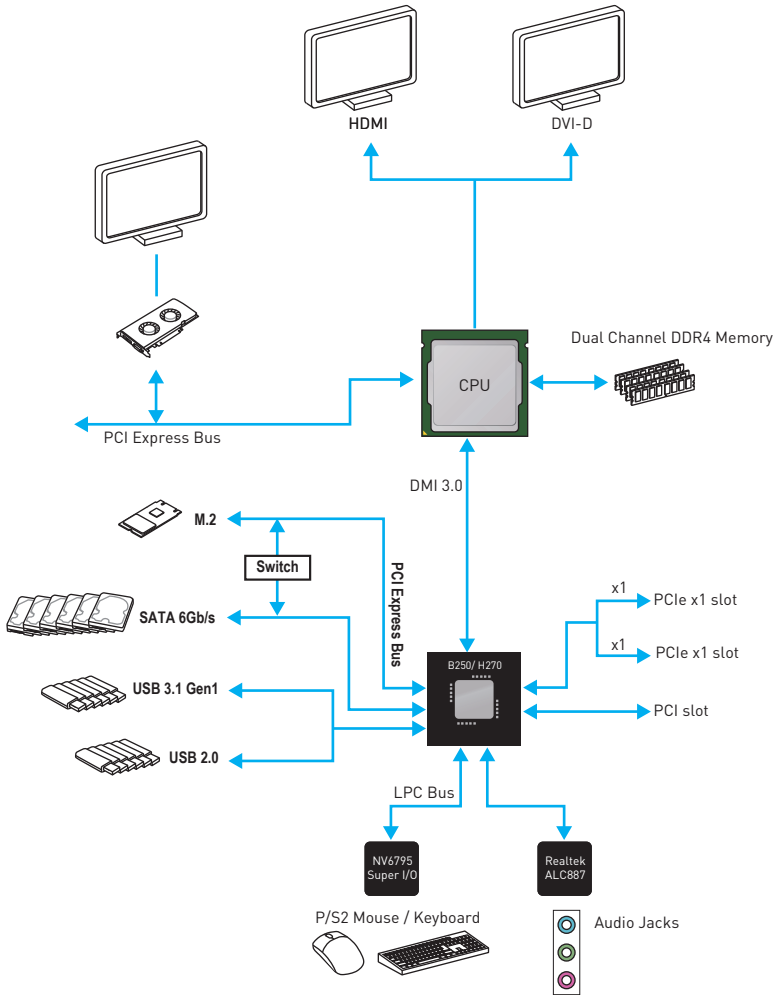

# Rear I/O Panel

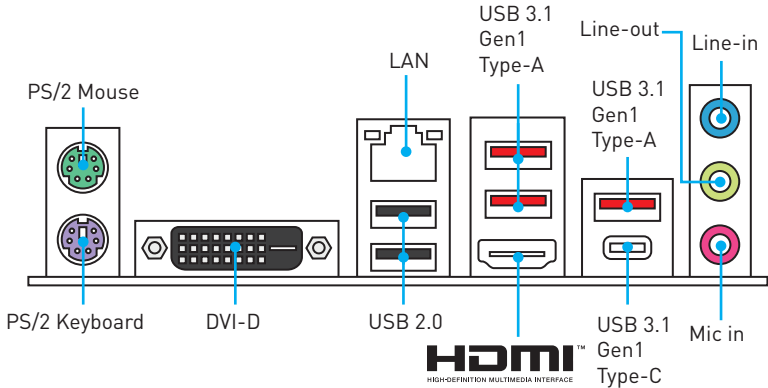

## LAN Port LED Status Table

Link/ Activity LED	
Status	Description
Off	No link
Yellow	Linked
Blinking	Data activity

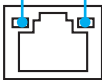

Speed LED	
Status	Description
Off	10 Mbps connection
Green	100 Mbps connection
Orange	1 Gbps connection

## Realtek HD Audio Manager

After installing the **Realtek HD Audio** driver, the **Realtek HD Audio Manager** icon will appear in the system tray. Double click on the icon to launch.

Device Selection

Application Enhancement

Main Volume

Profiles

Advanced Settings

Jack Status

Connector Strings

msi

Speaker Configuration

Sound Effects

Room Correction

Default Format

Stereo

Full-range Speakers

Front left and right

Surround speakers

Virtual Surround

ANALOG Back Panel

Front Panel

Main Volume

L R

- **Device Selection** - allows you to select a audio output source to change the related options. The **check** sign indicates the devices as default.
- **Application Enhancement** - the array of options will provide you a complete guidance of anticipated sound effect for both output and input device.
- **Main Volume** - controls the volume or balance the right/left side of the speakers that you plugged in front or rear panel by adjust the bar.
- **Profiles** - toggles between profiles.
- **Advanced Settings** - provides the mechanism to deal with 2 independent audio streams.
- **Jack Status** - depicts all render and capture devices currently connected with your computer.
- **Connector Settings** - configures the connection settings.

### Audio 7.1-channel Configuration

To configure 7.1-channel audio, you have to connect front audio I/O module to JAUD1 connector and follow the below steps.

1. Click on the **Advanced Settings** to open the dialog below.



2. Select **Mute the rear output device, when a front headphone plugged in.**
3. Plug your speakers to audio jacks on rear and front I/O panel. When you plug into a device at an audio jack, a dialogue window will pop up asking you which device is current connected.

# Overview of Components

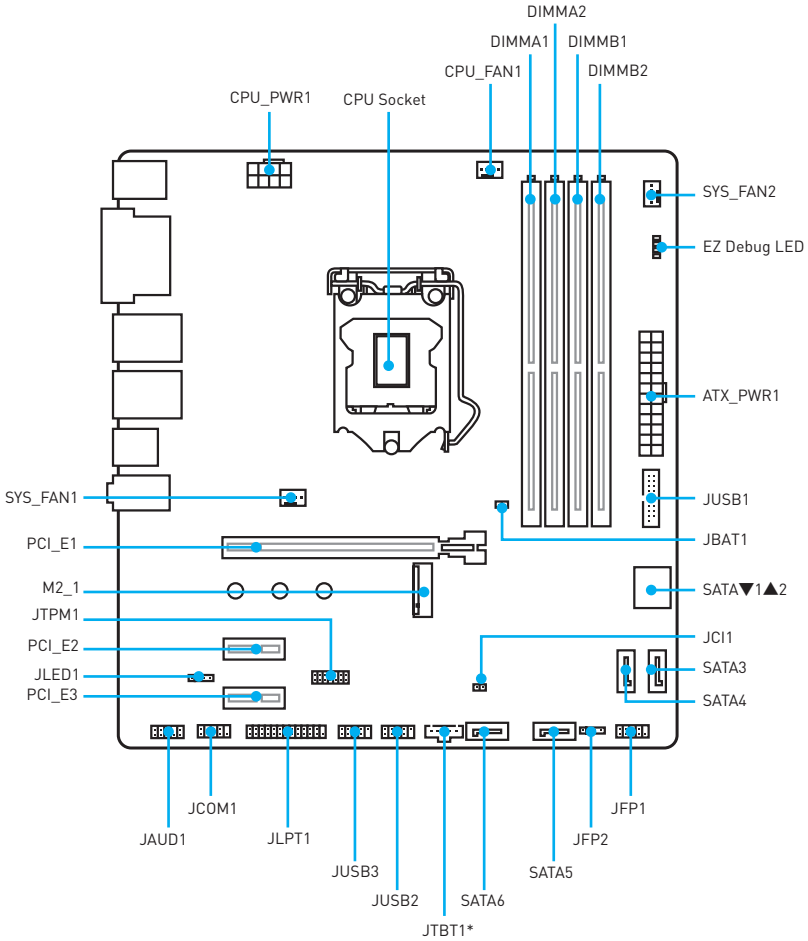

\* JTB1 is used to connect a specific card.

## Component Contents

Port Name	Port Type	Page
CPU_FAN1~2,SYS_FAN1~4	Fan Connectors	31
CPU_PWR1, ATX_PWR1	Power Connectors	29
CPU Socket	LGA1151 CPU Socket	24
DIMMA1, DIMMA2, DIMMB1,DIMMB2	DIMM Slots	25
JAUD1	Front Audio Connector	28
JBAT1	Clear CMOS (Reset BIOS) Jumper	34
JCI1	Chassis Intrusion Connector	32
JCOM1	Serial Port Connector	28
JFP1, JFP2	Front Panel Connectors	28
JLED1	RGB LED connector	33
JLPT1	Parallel Port Connector	33
JTPM1	TPM Module Connector	32
JUSB1	USB 3.1 Gen1 Connectors	30
JUSB2~3	USB 2.0 Connectors	30
M2_1	M.2 Slot (Key M)	27
PCI_E1~3	PCIe Expansion Slots	26
SATA1~6	SATA 6Gb/s Connectors	26

## CPU Socket

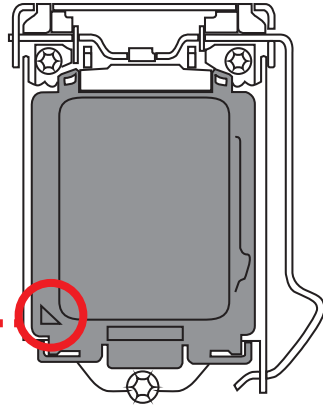
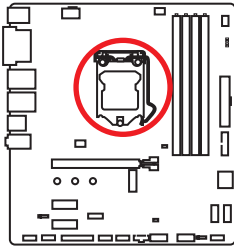

### Introduction to the LGA 1151 CPU

The surface of the LGA 1151 CPU has two **notches** and a **golden triangle** to assist in correctly lining up the CPU for motherboard placement. The golden triangle is the Pin 1 indicator.

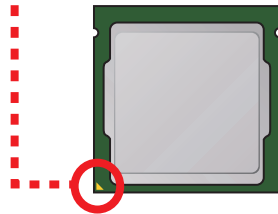

### Important

- Always unplug the power cord from the power outlet before installing or removing the CPU.
- Please retain the CPU protective cap after installing the processor. MSI will deal with Return Merchandise Authorization (RMA) requests if only the motherboard comes with the protective cap on the CPU socket.
- When installing a CPU, always remember to install a CPU heatsink. A CPU heatsink is necessary to prevent overheating and maintain system stability.
- Confirm that the CPU heatsink has formed a tight seal with the CPU before booting your system.
- Overheating can seriously damage the CPU and motherboard. Always make sure the cooling fans work properly to protect the CPU from overheating. Be sure to apply an even layer of thermal paste (or thermal tape) between the CPU and the heatsink to enhance heat dissipation.
- Whenever the CPU is not installed, always protect the CPU socket pins by covering the socket with the plastic cap.
- If you purchased a separate CPU and heatsink/ cooler, Please refer to the documentation in the heatsink/ cooler package for more details about installation.
- This motherboard is designed to support overclocking. Before attempting to overclock, please make sure that all other system components can tolerate overclocking. Any attempt to operate beyond product specifications is not recommended. MSI® does not guarantee the damages or risks caused by inadequate operation beyond product specifications.



## DIMM Slots

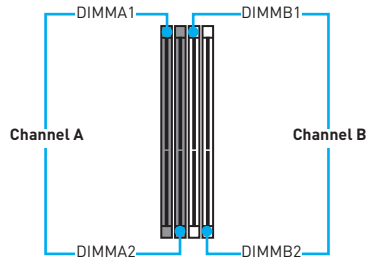
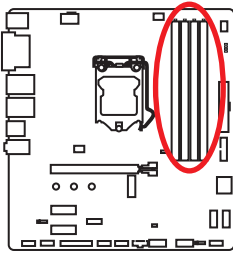

## Memory module installation recommendation

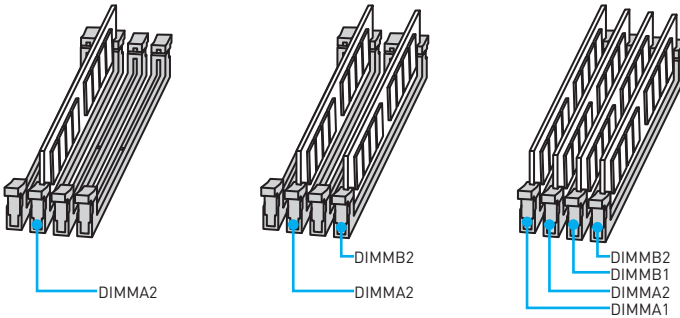

### Important

- Always insert memory modules in the **DIMMA2** slot first.
- Due to chipset resource usage, the available capacity of memory will be a little less than the amount of installed.
- Based on Intel CPU specification, the Memory DIMM voltage below 1.35V is suggested to protect the CPU.
- Please note that the maximum capacity of addressable memory is 4GB or less for 32-bit Windows OS due to the memory address limitation. Therefore, we recommended that you to install 64-bit Windows OS if you want to install more than 4GB memory on the motherboard.
- Some memory may operate at a lower frequency than the marked value when overlocking due to the memory frequency operates dependent on its Serial Presence Detect (SPD). Go to BIOS and find the **Memory Try It!** to set the memory frequency if you want to operate the memory at the marked or at a higher frequency.
- It is recommended to use a more efficient memory cooling system for full DIMMs installation or overlocking.
- The stability and compatibility of installed memory module depend on installed CPU and devices when overlocking.

## PCI\_E1~3: PCIe Expansion Slots

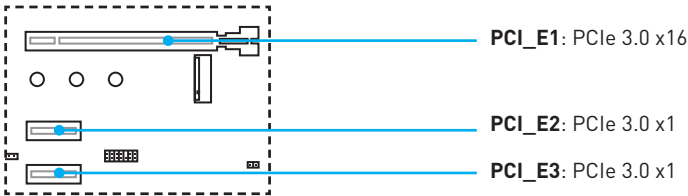

### Important

- When adding or removing expansion cards, always turn off the power supply and unplug the power supply power cable from the power outlet. Read the expansion card's documentation to check for any necessary additional hardware or software changes.
- If you install a large and heavy graphics card, you need to use a tool such as **MSI Gaming Series Graphics Card Bolster** to support its weight to prevent deformation of the slot.

## SATA1~6: SATA 6Gb/s Connectors

These connectors are SATA 6Gb/s interface ports. Each connector can connect to one SATA device.

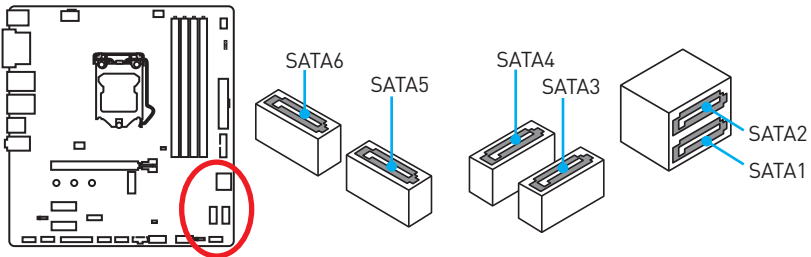

### Important

- Please do not fold the SATA cable at a 90-degree angle. Data loss may result during transmission otherwise.
- SATA cables have identical plugs on either sides of the cable. However, it is recommended that the flat connector be connected to the motherboard for space saving purposes.

## M2\_1: M.2 Slot (Key M)

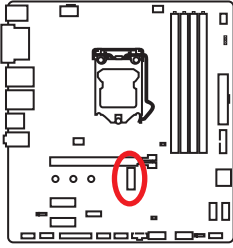

### Important

- Intel® RST only supports PCIe M.2 SSD with UEFI ROM, does not support Legacy ROM.
- The SATA1 port will be unavailable when an M.2 SATA SSD module has been installed in the M.2 slot.



### Video Demonstration

Watch the video to learn how to Install M.2 module.

<http://youtu.be/JCTFAByrYA>

## Installing M.2 module

1. Remove the screw from the base screw.
2. Remove the base screw.

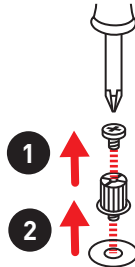

3. Tighten the base screw into the hole of the distance to the M.2 slot as the length your M.2 module.
4. Insert your M.2 module into the M.2 slot at a 30-degree angle.

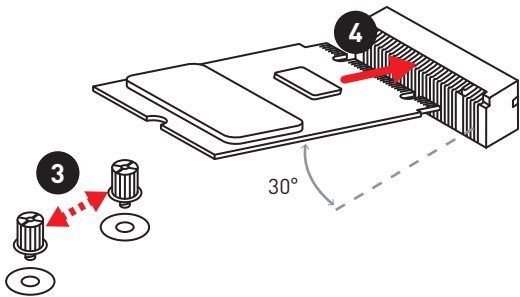

5. Put the screw in the notch on the trailing edge of your M.2 module and tighten it into the base screw.

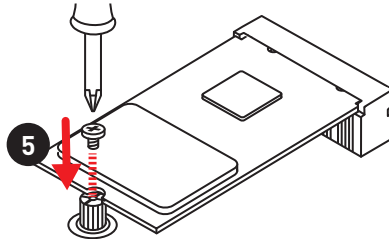

## JFP1, JFP2: Front Panel Connectors

These connectors connect to the switches and LEDs on the front panel.

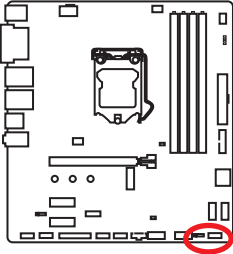

1	HDD LED +	2	Power LED +
3	HDD LED -	4	Power LED -
5	Reset Switch	6	Power Switch
7	Reset Switch	8	Power Switch
9	Reserved	10	No Pin

1	Speaker -	2	Buzzer +
3	Buzzer -	4	Speaker +

## JAUD1: Front Audio Connector

This connector allows you to connect audio jacks on the front panel.

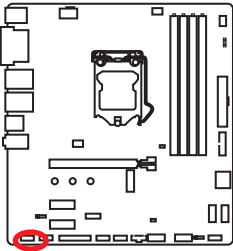

1	MIC L	2	Ground
3	MIC R	4	NC
5	Head Phone R	6	MIC Detection
7	SENSE_SEND	8	No Pin
9	Head Phone L	10	Head Phone Detection

## JCOM1: Serial Port Connector

This connector allows you to connect the optional serial port with bracket.

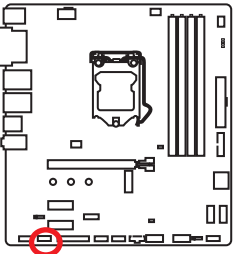

1	DCD	2	SIN
3	SOUT	4	DTR
5	Ground	6	DSR
7	RTS	8	CTS
9	RI	10	No Pin

## CPU\_PWR1, ATX\_PWR1: Power Connectors

These connectors allow you to connect an ATX power supply.

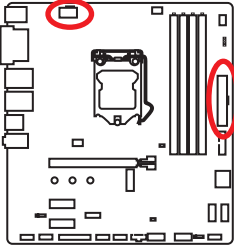

1	Ground	5	+12V
2	Ground	6	+12V
3	Ground	7	+12V
4	Ground	8	+12V

1	+3.3V	13	+3.3V
2	+3.3V	14	-12V
3	Ground	15	Ground
4	+5V	16	PS-ON#
5	Ground	17	Ground
6	+5V	18	Ground
7	Ground	19	Ground
8	PWR OK	20	Res
9	5VSB	21	+5V
10	+12V	22	+5V
11	+12V	23	+5V
12	+3.3V	24	Ground

### **Important**

Make sure that all the power cables are securely connected to a proper ATX power supply to ensure stable operation of the motherboard.

## JUSB2~3: USB 2.0 Connectors

These connectors allow you to connect USB 2.0 ports on the front panel.

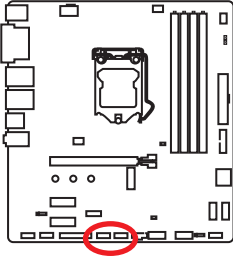

1	VCC	2	VCC
3	USB0-	4	USB1-
5	USB0+	6	USB1+
7	Ground	8	Ground
9	No Pin	10	NC



### Important

- Note that the VCC and Ground pins must be connected correctly to avoid possible damage.
- In order to recharge your iPad, iPhone and iPod through USB ports, please install MSI® SUPER CHARGER utility.

## JUSB1: USB 3.1 Gen1 Connectors

These connectors allow you to connect USB 3.1 Gen1 ports on the front panel.

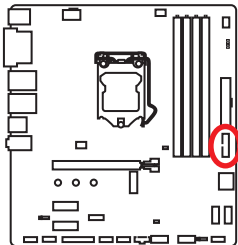

1	Power	11	USB2.0+
2	USB3_RX_DN	12	USB2.0-
3	USB3_RX_DP	13	Ground
4	Ground	14	USB3_TX_C_DP
5	USB3_TX_C_DN	15	USB3_TX_C_DN
6	USB3_TX_C_DP	16	Ground
7	Ground	17	USB3_RX_DP
8	USB2.0-	18	USB3_RX_DN
9	USB2.0+	19	Power
10	NC	20	No Pin



### Important

Note that the Power and Ground pins must be connected correctly to avoid possible damage.

## CPU\_FAN1~2, SYS\_FAN1~4: Fan Connectors

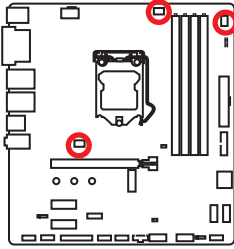

Fan connectors can be classified as PWM (Pulse Width Modulation) Mode and DC Mode. PWM Mode fan connectors provide constant 12V output and adjust fan speed with speed control signal. DC Mode fan connectors control fan speed by changing voltage. When you plug a 3-pin (Non-PWM) fan to a PWM Mode fan connector, the fan speed will be always maintained at 100%, and that could be noisy.



PWM Mode fan connector

 CPU_FAN1			
1	Ground	2	+12V
3	Sense	4	Speed Control Signal

DC Mode fan connector

 SYS_FAN1		 SYS_FAN2	
1	Ground	2	Voltage Control
3	Sense	4	NC

## Switching fan mode and adjusting fan speed

You can switch between PWM mode and DC mode and adjust fan speed in **BIOS > Advanced > Hardware Monitor**.

Select **PWM Mode** or **DC Mode**

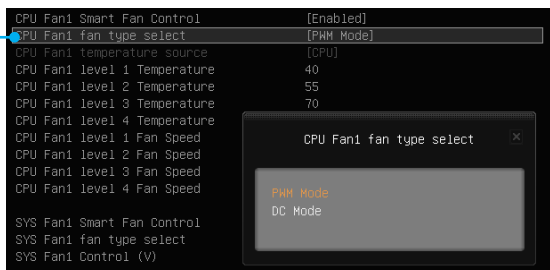

In **Hardware Monitor** sub-menu, you can set the temperature levels and the corresponding fan speed levels.



**Important**  
Make sure fans are working properly after switching the PWM/ DC mode.

## JCI1: Chassis Intrusion Connector

This connector allows you to connect the chassis intrusion switch cable.

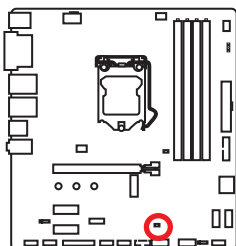

Normal  
(default)



Trigger the chassis  
intrusion event

### Using chassis intrusion detector

1. Connect the **JCI1** connector to the chassis intrusion switch/ sensor on the chassis.
2. Close the chassis cover.
3. Go to **BIOS > Settings > Security > Chassis Intrusion Configuration**.
4. Set **Chassis Intrusion** to **Enabled**.
5. Press **F10** to save and exit and then press the **Enter** key to select **Yes**.
6. Once the chassis cover is opened again, a warning message will be displayed on screen when the computer is turned on.

### Resetting the chassis intrusion warning

1. Go to **BIOS > Settings > Security > Chassis Intrusion Configuration**.
2. Set **Chassis Intrusion** to **Reset**.
3. Press **F10** to save and exit and then press the **Enter** key to select **Yes**.

## JTPM1: TPM Module Connector

This connector is for TPM (Trusted Platform Module). Please refer to the TPM security platform manual for more details and usages.

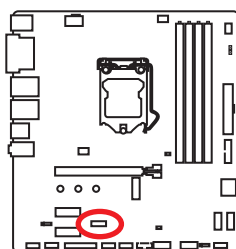

1	LPC Clock	2	3V Standby power
3	LPC Reset	4	3.3V Power
5	LPC address & data pin0	6	Serial IRQ
7	LPC address & data pin1	8	5V Power
9	LPC address & data pin2	10	No Pin
11	LPC address & data pin3	12	Ground
13	LPC Frame	14	Ground



## JLED1: RGB LED connector

These connectors allow you to connect the 5050 RGB LED strips.

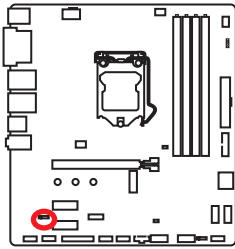

1	+12V	2	G
3	R	4	B

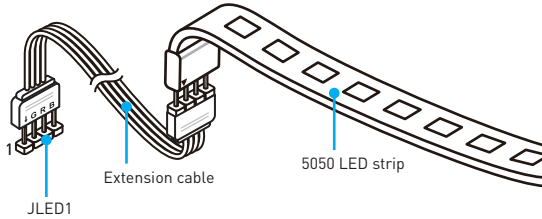

### Important

- This connector supports 5050 RGB multi-color LED strips (12V/G/R/B) with the maximum power rating of 3A (12V). Please keeping the LED strip shorter than 2 meters to prevent dimming.
- Always turn off the power supply and unplug the power cord from the power outlet before installing or removing the RGB LED strip.
- Please use the **LED Effect** of GAMING APP to adjust, calibrate and control the LED light, refer to the Software section for details.

## JLPT1: Parallel Port Connector

This connector allows you to connect the optional parallel port with bracket.

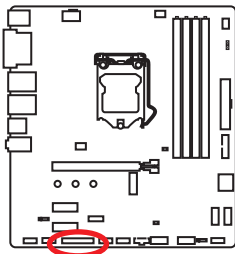

1	RSTB#	2	AFD#	3	PRND0
4	ERR#	5	PRND1	6	PINIT#
7	PRND2	8	LPT_SLIN#	9	PRND3
10	Ground	11	PRND4	12	Ground
13	PRND5	14	Ground	15	PRND6
16	Ground	17	PRND7	18	Ground
19	ACK#	20	Ground	21	BUSY
22	Ground	23	PE	24	Ground
25	SLCT	26	No Pin		

## JBAT1: Clear CMOS (Reset BIOS) Jumper

There is CMOS memory onboard that is external powered from a battery located on the motherboard to save system configuration data. If you want to clear the system configuration, set the jumpers to clear the CMOS memory.

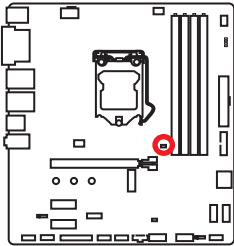

Keep Data  
(default)



Clear CMOS/  
Reset BIOS

### Resetting BIOS to default values

1. Power off the computer and unplug the power cord
2. Use a jumper cap to short JBAT1 for about 5-10 seconds.
3. Remove the jumper cap from JBAT1.
4. Plug the power cord and power on the computer.

### EZ Debug LED

These LEDs indicate the debug status of the motherboard.

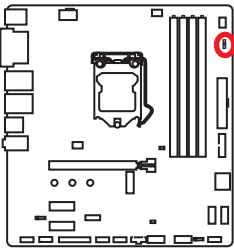

- CPU** - indicates CPU is not detected or fail.
- DRAM** - indicates DRAM is not detected or fail.
- VGA** - indicates GPU is not detected or fail.
- BOOT** - indicates the booting device is not detected or fail.

# BIOS Setup

The default settings offer the optimal performance for system stability in normal conditions. You should **always keep the default settings** to avoid possible system damage or failure booting unless you are familiar with BIOS.

## Important

- BIOS items are continuous update for better system performance. Therefore, the description may be slightly different from the latest BIOS and should be held for reference only. You could also refer to the **HELP** information panel for BIOS item description.
- The pictures in this chapter are for reference only and may vary from the product you purchased.

## Entering BIOS Setup

Please refer the following methods to enter BIOS setup.

- Press **Delete** key, when the **Press DEL key to enter Setup Menu, F11 to enter Boot Menu** message appears on the screen during the boot process.
- Use MSI FAST BOOT application. Click on **GO2BIOS** button and choose **OK**. The system will reboot and enter BIOS setup directly.



Click on **GO2BIOS**

## Function key

Key	Function	Key	Function
F1	General Help	F4	Enter CPU Specifications menu
F5	Enter Memory-Z menu	F6	Load optimized defaults
F10	Save Change and Reset*	F12	Take a screenshot and save it to USB flash drive (FAT/ FAT32 format only).

\* When you press F10, a confirmation window which provides the modification information appears. Select between **Yes** or **No** to confirm your choice.

## Resetting BIOS

You might need to restore the default BIOS setting to solve certain problems. There are several ways to reset BIOS:

- Go to BIOS and press **F6** to load optimized defaults.
- Short the **Clear CMOS** jumper on the motherboard.



### **Important**

Please refer to the **Clear CMOS** jumper/ button section for resetting BIOS.

## Updating BIOS

### Updating BIOS with M-FLASH

Before updating:

Please download the latest BIOS file that matches your motherboard model from MSI website. And then save the BIOS file into the USB flash drive.

Updating BIOS:

1. Insert the USB flash drive that contains the update file into the computer.
2. Reboot the system, and then press **Del** key to enter the BIOS Setup during POST.
3. Go to **BIOS > M-FLASH > Select one file to update BIOS and ME**, select a BIOS file to perform the BIOS update process.
4. After the flashing process is 100% complete, the system will reboot.

### Updating the BIOS with Live Update 6

Before updating:

Make sure the LAN driver is already installed and the internet connection is set properly.

Updating BIOS:

1. Install and launch MSI LIVE UPDATE 6.
2. Select **Manual scan**.
3. Check **MB BIOS** box and click on **Scan** button.
4. Select the **MB BIOS** and click on  icon to download and install the latest BIOS file.
5. Click **Next** and choose **In Windows mode**. And then click **Next** and **Start** to start updating BIOS.
6. After the flashing process is 100% completed, the system will restart automatically.

## System Status Menu

After entering BIOS, the following screen is displayed. The System Status Menu allows you to configure basic system settings, such as time, date etc.

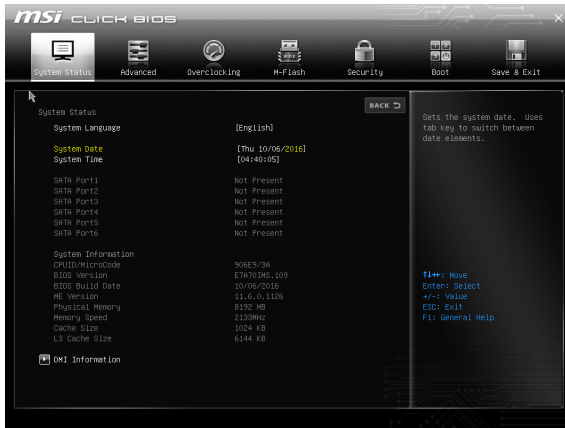

### ▶ System Language [English]

Allows you to select the language of BIOS setup.

### ▶ System Date

Sets the system date. Use tab key to switch between date elements.

The format is <day> <month> <date> <year>.

<day> Day of the week, from Sun to Sat, determined by BIOS. Read-only.

<month> The month from Jan. through Dec.

<date> The date from 1 to 31 can be keyed by numeric function keys.

<year> The year can be adjusted by users.

### ▶ System Time

Sets the system time. Use tab key to switch between time elements.

The time format is <hour> <minute> <second>.

### ▶ SATA PortX

Shows the information of connected SATA device.



### **Important**

*If the connected SATA device is not displayed, turn off computer and re-check SATA cable and power cable connections of the device and motherboard.*

### ▶ System Information

Shows detailed system information, including CPU type, BIOS version, and Memory (read only).

### ▶ DMI Information

Shows system information, desktop Board Information and chassis Information. (Read only).

## Advanced Menu

The Advanced Menu allows you to set up the items of special enhanced features.

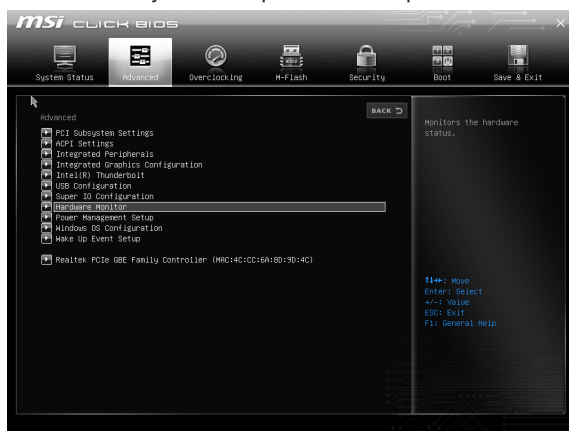

### ► PCI Subsystem Settings

Sets PCI, PCI express interface protocol and latency timer. Press <Enter> to enter the sub-menu.

#### ► PEG X - Max Link Speed [Auto]

Sets PCI Express protocol of PCIe x16 slots for matching different installed devices.

[Auto] This item will be configured automatically by BIOS.

[Gen1] Enables PCIe Gen1 support only.

[Gen2] Enables PCIe Gen2 support only.

[Gen3] Enables PCIe Gen3 support only.

#### ► PCI Latency Timer [32]

Sets latency timer of PCI interface device.

[Options: 32, 64, 96, 128, 160, 192, 224, 248 PCI Bus clocks]

#### ► Above 4G Decoding [Disabled]

Enables or disables 64-bit capable devices to be decoded in above 4G address space. It is only available if the system supports 64-bit PCI decoding.

### ► ACPI Settings

Sets ACPI parameters of onboard power LED behaviors. Press <Enter> to enter the sub-menu.

#### ► Power LED [Blinking]

Sets shining behaviors of the onboard Power LED.

[Dual Color] The power LED turns to another color to indicate the S3 state.

[Blinking] The power LED blinks to indicate the S3 state.

### ► Integrated Peripherals

Sets integrated peripherals' parameters, such as LAN, HDD, USB and audio. Press <Enter> to enter the sub-menu.

▶ **Onboard LAN Controller [Enabled]**

Enables or disables the onboard LAN controller.

▶ **LAN Option ROM [Disabled]**

Enables or disables the legacy network Boot Option ROM for detailed settings. This item will appear when **Onboard LAN Controller** is enabled.

[Enabled] Enables the onboard LAN Boot ROM.

[Disabled] Disables the onboard LAN Boot ROM.

▶ **Network Stack [Disabled]**

Sets UEFI network stack for optimizing IPv4 / IPv6 function.

[Enabled] Enables UEFI network stack.

[Disabled] Disables UEFI network stack.

▶ **Ipv4 PXE Support [Enabled]**

When “Enabled”, the system UEFI network stack will support Ipv4 protocol. This item will appear when “Network Stack” is enabled.

[Enabled] Enables the Ipv4 PXE boot support.

[Disabled] Disables the Ipv4 PXE boot support.

▶ **Ipv6 PXE Support [Enabled]**

When “Enabled”, the system UEFI network stack will support Ipv6 protocol. This item will appear when “Network Stack” is enabled.

[Enabled] Enables the Ipv6 PXE boot support.

[Disabled] Disables the Ipv6 PXE boot support.

▶ **SATA Mode [AHCI Mode]**

Sets the operation mode of the onboard SATA controller.

[AHCI Mode] Specify the AHCI mode for SATA storage devices. AHCI (Advanced Host Controller Interface) offers some advanced features to enhance the speed and performance of SATA storage device, such as Native Command Queuing (NCQ) and hot-plugging.

[RAID Mode] Enables RAID function for SATA storage devices.

▶ **SATAx Hot Plug [Disabled]**

Allows user to enable or disable the SATA hot plug support.

[Enabled] Enables hot plug support for the SATA ports.

[Disabled] Disables hot plug support for the SATA ports.

▶ **HD Audio Controller [Enabled]**

Enables or disables the onboard High Definition Audio controller.

▶ **HPET [Enabled]**

Enables or disables the HPET (High Precision Event Timers) support.

▶ **Integrated Graphics Configuration**

Adjusts integrated graphics settings for optimum system. Press <Enter> to enter the sub-menu.

▶ **Initiate Graphic Adapter [PEG]**

Selects a graphics device as the primary boot device.

[IGD]            Integrated Graphics Display.

[PEG]            PCI-Express Graphics Device.

▶ **Integrated Graphics Share Memory [64M]**

Selects a fixed amount of system memory allocated to the onboard graphics. This item will appear when **IGD Multi-Monitor** is enabled.

▶ **IGD Multi-Monitor [Disabled]**

Enables or disables the multi-screen output from integrated graphics and external graphics card.

[Enabled]        Enables multi-screen function for both integrated and external graphics cards.

[Disabled]       Disables this function.

▶ **Intel(R) Thunderbolt [Fully Disabled]**

▶ **Thunderbolt(TM) Support**

Enables or disables Thunderbolt™ support.

▶ **USB Configuration**

Sets the onboard USB controller and device function. Press <Enter> to enter the sub-menu.

▶ **USB Controller [Enabled]**

Enables or disables all USB controller.

▶ **XHCI Hand-off [Enabled]**

Enables or disables XHCI hand-off support for the operating system without XHCI hand-off feature. This item will appear when **USB Controller** is enabled.

▶ **Legacy USB Support [Enabled]**

Sets Legacy USB function support.

[Auto]            The system will automatically detect if any USB device is connected and enables or disables the legacy USB support.

[Enabled]        Enable the USB support for legacy operating systems that do not support USB.

[Disabled]       The USB devices are available only for UEFI applications.

▶ **Super IO Configuration**

Sets system Super I/O chip parameters including LPT and COM ports. Press <Enter> to enter the sub-menu.

▶ **Serial (COM) Port x Configuration**

Sets detailed configuration of serial(COM) port x. Press <Enter> to enter the sub-menu.

▶ **Serial (COM) Port x [Enabled]**

Enables or disables serial (COM) port x.



▶ **Serial (COM) Port x Settings [Auto]**

Sets serial port x (COM). If set to Auto, BIOS will optimize the IRQ automatically or you can set it manually.

▶ **Parallel (LPT) Port Configuration**

Sets detailed configuration of parallel port (LPT). Press <Enter> to enter the sub-menu.

▶ **Parallel (LPT) Port [Enabled]**

Enables or disables parallel(LPT) port.

▶ **Parallel (LPT) Port Settings [Auto]**

Sets parallel port (LPT). If set to Auto, BIOS will optimize the IRQ automatically or you can set it manually.

▶ **Device Mode [STD Printer Mode]**

Selects an operating mode for parallel port.

[STD Printer Mode]	Printer port mode
[SPP]	Standard Parallel Port mode
[EPP-1.9/ 1.7 + SPP]	Enhanced Parallel Port-1.9/ 1.7 mode + Standard Parallel Port mode.
[ECP]	Extended Capability Port mode
[ECP + EPP-1.9/ 1.7]	Extended Capability Port mode + Enhanced Parallel Port-1.9/ 1.7 mode.

▶ **Hardware Monitor**

Sets fan speeds. Press <Enter> to enter the sub-menu.

▶ **CPU/ SYS FanX Smart Fan Control [Enabled]**

Enables or disables the smart fan control. Smart Fan Control automatically controls fan speed depending on target temperature and to keep it with a specific operating speed. When the temperature is over the maximum temperature, the fan will operate maximum speed. When the temperature is under the minimum temperature, the fan will operate minimum speed.

▶ **CPU/ SYS FanX fan type select [PWM Mode/ DC Mode]**

Sets PWM mode or DC mode for installed CPU/ system fan.

▶ **CPU/ SYS FanX level 1~4 Temperature [40, 55, 70, 85]**

Sets target temperature for level 1 to 4 (low to high). The fan will operate designate speed according to level 1~4 target temperatures. These items will be un-available when Smart Fan Control is disabled.

▶ **CPU/ SYS FanX level 1~4 Fan Speed [13, 38, 63, 100]**

Sets fan duty cycle (%) for level 1 to 4 (low to high). The fan will operate designate duty cycle according to level 1~4 target temperatures. These items will be un-available when Smart Fan Control is disabled.

▶ **CPU Fan Fail Warning Control [Disabled]**

Enables or disables to show the CPU fan fail warning message on the POST.

▶ **CPU temperature Warning Control [Disabled]**

Enables or disables to show the CPU high temperature warning message.

▶ **Power Management Setup**

Sets system Power Management of EuP2013 and AC Power Loss behaviors. Press <Enter> to enter the sub-menu.

▶ **EuP 2013 [Disabled]**

Enables or disables the system power consumption according to EuP2013 regulation.

[Enabled] Optimize the system power consumption according to EuP 2013 regulation. It will not support S4 & S5 wake up by USB, PCI and PCIe devices.

[Disabled] Disables this function.

▶ **Restore after AC Power Loss [Power Off]**

Sets the system behaviors while encountering the AC power loss.

[Power Off] Leaves the system in power off state after restoring AC power.

[Power On] Boot up the system after restoring AC power.

[Last State] Restores the system to the previous state (power on/ power off) before AC power loss.

▶ **System Power Fault Protection [Disabled]**

Enables or disables the system to boot up when detecting abnormal voltage input.

[Enabled] Protect the system from unexpected power operation and remain the shut down status.

[Disabled] Disables this function.

▶ **Windows OS Configuration**

Sets Windows 8/ 8.1 detailed configuration and behaviors. Press <Enter> to enter the sub-menu.

▶ **Windows 8.1/ 10 WHQL Support [Disabled]**

Enables the supports for Windows 8.1/ 10 or disables for other operating systems. Before enabling this item, make sure all installed devices & utilities (hardware & software) should meet the Windows 8.1/ 10 requirements.

[Enabled] The system will switch to UEFI mode to meet the Windows requirement.

[Disabled] Disables this function.

▶ **MSI Fast Boot [Disabled]**

MSI Fast Boot is the fastest way to boot the system. It will disable more devices to speed up system boot time which is faster than the boot time of **Fast Boot**.

[Enabled] Enables the MSI Fast Boot function to speed up booting time. And the following **Fast Boot** field will be disabled and fixed.

[Disabled] Disables MSI Fast Boot.



**Important**

When MSI Fast Boot is enabled, you can use **FAST BOOT** application to enter BIOS setup if needed. Please refer to page 35 for Entering BIOS Setup.

▶ **Fast Boot [Disabled/ windows7, Enabled/ windows 8.1/ 10]**

Enables or disables the fast boot feature for Windows 8.1/ 10. This item will only be available when **MSI Fast Boot** is disabled.

[Enabled] Enables the Fast Boot configuration to accelerate system boot time.

[Disabled] Disables the Fast Boot configuration.

▶ **Internal GOP Configuration**

Manages the onboard Graphics Output Protocol (GOP). Press <Enter> to enter the sub-menu. This sub-menu appear when **Windows 8.1/ 10 WHQL Support** is enabled.

▶ **Secure Boot**

Sets the Windows secure boot to prevent the unauthorized accessing. Press <Enter> to enter the sub-menu. This sub-menu appear when **Windows 8.1/ 10 WHQL Support** is enabled.

▶ **Secure Boot Support [Disabled]**

Enables or disables secure boot support.

[Enabled] Enables the secure boot function and allow you to set the secure boot settings.

[Disabled] Disables this function.

▶ **Secure Boot Mode [Standard]**

Selects the secure boot mode. This item is to select how the secure boot keys be loaded. This item appears when **Secure Boot Support** is enabled.

[Standard] The system will automatically load the secure keys from BIOS.

[Custom] Allows user to configure the secure boot settings and manually load the secure keys.

▶ **Key Management**

Manages the secure boot keys. Press <Enter> to enter the sub-menu. This sub-menu will appear when **Secure Boot Mode** sets to [Custom].

▶ **Wake Up Event Setup**

Sets system wake up behaviors for different sleep modes. Press <Enter> to enter the sub-menu.

▶ **Wake Up Event By [BIOS]**

Selects the wake up event by BIOS or operating system.

[BIOS] Activates the following items, set wake up events of these items.

[OS] The wake up events will be defined by OS.

▶ **Resume By RTC Alarm [Disabled]**

Disables or enables the system wake up by RTC Alarm.

[Enabled] Enables the system to boot up on a scheduled time/ date.

[Disabled] Disables this function.

▶ **Date (of month) Alarm/ Time (hh:mm:ss) Alarm**

Sets RTC alarm date/ Time. If Resume By RTC Alarm is set to [Enabled], the system will automatically resume (boot up) on a specified date/hour/minute/second in these fields (using the <+> and <-> to select the date & time settings).

▶ **Resume By PCI-E Device [Disabled]**

Enables or disables the system wake up by PCI express device.

[Enabled] Enables the system to be awakened from the power saving modes when activity or input signal of PCI/ PCIe device is detected.

[Disabled] Disables this function.

▶ **Resume by USB Device [Disabled]**

Disables or enables the system wake up by USB devices.

[Enabled] Enables the system to be awakened from sleep state when activity of USB device is detected.

[Disabled] Disables this function.

▶ **Resume From S3/S4/S5 by PS/2 Mouse [Disabled]**

Disables or enables the system wake up by PS/2 mouse.

[Enabled] Enables the system to be awakened from S3/ S4/ S5 state when activity of PS/2 mouse is detected.

[Disabled] Disables this function.

▶ **Resume From S3/S4/S5 by PS/2 Keyboard [Disabled]**

Disables or enables the system wake up by PS/2 keyboard.

[Any Key] Enables the system to be awakened from S3/ S4/ S5 state when activity of any key on PS/2 keyboard is detected.

[Hot Key] Enables the system to be awakened from S3/ S4/ S5 state when activity of hot key on PS/2 keyboard is detected.

[Disabled] Disables this function.

▶ **Hot Key [Ctrl+Space]**

Selects a combination of keys as a hot key to awake the system. This item appears when you set the Resume From S3/S4/S5 by PS/2 Keyboard to **Hot Key**.

## Overclocking Menu

The Overclocking Menu allows you to adjust the frequency and voltage. Increasing the frequency may get better performance.



### **Important**

- Overclocking your PC manually is only recommended for advanced users.
- Overclocking is not guaranteed, and if done improperly, it could void your warranty or severely damage your hardware.

#### ▶ **OC Explore Mode [Normal]**

Enables or disables to show the normal or expert version of OC settings.

[Normal] Provides the regular OC settings in BIOS setup.

[Expert] Provides the advanced OC settings for OC expert to configure in BIOS setup.

Note: We use \* as the symbol for the OC settings of Expert mode.

#### ▶ **CPU Ratio Apply Mode [All Core]\***

Sets applied mode for CPU ratio. This item only appears when a CPU that supports **Turbo Boost** is installed.

[All Core] Activate the **CPU Ratio** field. All CPU cores will run the same CPU ratio that be set in **CPU Ratio**.

[Per Core] Activate the **X-Core Ratio Limit** field. Sets each CPU core ratio separately in **X-Core Ratio Limit**.

#### ▶ **CPU Ratio [Auto]**

Sets the CPU ratio that is used to determine CPU clock speed. This item can only be changed if the processor supports this function.

#### ▶ **1/2/3/4-Core Ratio Limit [Auto]**

Allows you to set the CPU ratios for different number of active cores. These items only appear when a CPU that support this function is installed.

▶ **Adjusted CPU Frequency**

Shows the adjusted CPU frequency. Read-only.

▶ **CPU Ratio Offset When Running AVX [Auto]\***

Sets a offset value to lower the CPU core ratio. It could be helpful for heat dissipation when running AVX instruction set. If set to Auto, BIOS will configure this setting automatically.

▶ **CPU Ratio Mode [Dynamic Mode]\***

Selects the CPU Ratio operating mode. This item will appear when you set the CPU ratio manually.

[Fixed Mode]      Fixes the CPU ratio.

[Dynamic Mode]    CPU ratio will be changed dynamically according to the CPU loading.

▶ **Ring Ratio [Auto]**

Sets the ring ratio. The valid value range depends on the installed CPU.

▶ **Adjusted Ring Frequency**

Shows the adjusted Ring frequency. Read-only.

▶ **GT Ratio [Auto]**

Sets the integrated graphics ratio. The valid value range depends on the installed CPU.

▶ **Adjusted GT Frequency**

Shows the adjusted integrated graphics frequency. Read-only.

▶ **EIST [Enabled]\***

Enables or disables the Enhanced Intel® SpeedStep Technology.

[Enabled]      Enables the EIST to adjust CPU voltage and core frequency dynamically. It can decrease average power consumption and average heat production.

[Disabled]      Disables EIST.

▶ **Intel Turbo Boost [Enabled]\***

Enables or disables the Intel® Turbo Boost. This item appears when the installed CPU supports this function.

[Enabled]      Enables this function to boost CPU performance automatically above rated specifications when system request the highest performance state.

[Disabled]      Disables this function.

▶ **Extreme Memory Profile (X.M.P.) [Disabled]**

X.M.P. (Extreme Memory Profile) is the overclocking technology by memory module. This item will be available when the memory modules that support X.M.P. is installed.

[Disabled]      Disables this function.

[Profile 1]      Uses profile1 settings of XMP memory module.

[Profile 2]      Uses profile2 settings of XMP memory module.

▶ **DRAM Reference Clock [Auto]\***

Sets the DRAM reference clock. The valid value range depends on the installed CPU. This item appears when a CPU that supports this adjustment is installed.

▶ **DRAM Frequency [Auto]**

Sets the DRAM frequency. Please note the overclocking behavior is not guaranteed.

▶ **Adjusted DRAM Frequency**

Shows the adjusted DRAM frequency. Read-only.

▶ **Memory Try It ! [Disabled]**

It can improve memory compatibility or performance by choosing optimized memory preset.

▶ **DRAM Timing Mode [Link]**

Selects the memory timing mode.

[Link]            Allows user to configure the DRAM timing for all memory channel.

[UnLink]        Allows user to configure the DRAM timing for respective memory channel.

▶ **Advanced DRAM Configuration**

Press <Enter> to enter the sub-menu. User can set the memory timing for each/ all memory channel. The system may become unstable or unbootable after changing memory timing. If it occurs, please clear the CMOS data and restore the default settings. (Refer to the Clear CMOS jumper/ button section to clear the CMOS data, and enter the BIOS to load the default settings.)

▶ **Memory Fast Boot [Auto] \***

Enables or disables the initiation and training for memory every booting.

[Auto]            The setting will be configured automatically by BIOS.

[Enabled]        System will completely keep the archives of first initiation and training for memory. So the memory will not be initialed and trained when booting to accelerate the system booting time.

[Disabled]       The memory will be initialed and trained every booting.

▶ **CPU Voltages control [Auto]**

These options allows you to set the voltages related to CPU. If set to **Auto**, BIOS will set these voltages automatically or you can set it manually.

▶ **DRAM Voltages control [Auto]**

These options allows you to set the voltages related to memory. If set to **Auto**, BIOS will set these voltages automatically or you can set it manually.

▶ **PCH Voltages control [Auto]**

These options allows you to set the voltages related to PCH. If set to **Auto**, BIOS will set these voltages automatically or you can set it manually.

▶ **CPU Memory Changed Detect [Enabled]\***

Enables or disables the system to issue a warning message during boot when the CPU or memory has been replaced.

[Enabled] The system will issue a warning message during boot and then you have to load the default settings for new devices.

[Disabled] Disables this function and keeps the current BIOS settings.

▶ **CPU Specifications**

Press <Enter> to enter the sub-menu. This sub-menu displays the information of installed CPU. You can also access this information menu at any time by pressing [F4]. Read only.

▶ **CPU Technology Support**

Press <Enter> to enter the sub-menu. The sub-menu shows the key features of installed CPU. Read only.

▶ **MEMORY-Z**

Press <Enter> to enter the sub-menu. This sub-menu displays all the settings and timings of installed memory. You can also access this information menu at any time by pressing [F5].

▶ **DIMMx Memory SPD**

Press <Enter> to enter the sub-menu. The sub-menu displays the information of installed memory. Read only.

▶ **CPU Features**

Press <Enter> to enter the sub-menu.

▶ **Hyper-Threading [Enabled]**

Intel Hyper-Threading technology treats the multi cores inside the processor as multi logical processors that can execute instructions simultaneously. In this way, the system performance is highly improved. This item appears when the installed CPU supports this technology.

[Enable] Enables Intel Hyper-Threading technology.

[Disabled] Disables this item if the system does not support HT function.

▶ **Active Processor Cores [All]**

Allows you to select the number of active CPU cores.

▶ **Limit CPUID Maximum [Disabled]**

Enables or disables the extended CPUID value.

[Enabled] BIOS limits the maximum CPUID input value to circumvent boot problems with older operating system that do not support the processor with extended CPUID value.

[Disabled] Use the actual maximum CPUID input value.



▶ **Intel Virtualization Tech [Enabled]**

Enables or disables Intel Virtualization technology.

[Enabled] Enables Intel Virtualization technology and allows a platform to run multiple operating systems in independent partitions. The system can function as multiple systems virtually.

[Disabled] Disables this function.

▶ **Intel VT-D Tech [Disabled]**

Enables or disables Intel VT-D (Intel Virtualization for Directed I/O) technology.

▶ **Hardware Prefetcher [Enabled]**

Enables or disables the hardware prefetcher (MLC Streamer prefetcher).

[Enabled] Allows the hardware prefetcher to automatically pre-fetch data and instructions into L2 cache from memory for tuning the CPU performance.

[Disabled] Disables the hardware prefetcher.

▶ **Adjacent Cache Line Prefetch [Enabled]**

Enables or disables the CPU hardware prefetcher (MLC Spatial prefetcher).

[Enabled] Enables adjacent cache line prefetching for reducing the cache latency time and tuning the performance to the specific application.

[Disabled] Enables the requested cache line only.

▶ **CPU AES Instructions [Enabled]**

Enables or disables the CPU AES (Advanced Encryption Standard-New Instructions) support. This item appears when a CPU supports this function.

▶ **Intel Adaptive Thermal Monitor [Enabled]**

Enables or disables the Intel adaptive thermal monitor function to protect the CPU from overheating.

[Enabled] Throttles down the CPU core clock speed when the CPU is over the adaptive temperature.

[Disabled] Disables this function.

▶ **Intel C-State [Auto]**

Enables or disables the Intel C-state. C-state is a processor power management technology defined by ACPI.

[Auto] This setting will be configured automatically by BIOS.

[Enabled] Detects the idle state of system and reduce CPU power consumption accordingly.

[Disabled] Disable this function.

▶ **C1E Support [Disabled]**

Enables or disables the C1E function for power-saving in halt state. This item appears when **Intel C-State** is enabled.

[Enabled] Enables C1E function to reduce the CPU frequency and voltage for power-saving in halt state.

[Disabled] Disables this function.

▶ **Package C State limit [Auto]**

This item allows you to select a CPU C-state level for power-saving when system is idle. The options of C-state depend on the installed CPU. This item appears when **Intel C-State** is enabled.

▶ **CFG Lock [Enabled]**

Lock or un-lock the MSR 0xE2[15], CFG lock bit.

[Enabled] Locks the CFG lock bit.

[Disabled] Un-locks the CFG lock bit.

▶ **EIST [Enabled]**

Enables or disables the Enhanced Intel® SpeedStep Technology. This item will appear when **OC Explore Mode** is set to **Normal**.

[Enabled] Enables the EIST to adjust CPU voltage and core frequency dynamically. It can decrease average power consumption and average heat production.

[Disabled] Disables EIST.

▶ **Intel Turbo Boost [Enabled]**

Enables or disables the Intel® Turbo Boost. This item is for **Normal mode** and appears when a CPU that support Turbo Boost is installed.

[Enabled] Enables this function to boost CPU performance automatically over specification when system request the highest performance state.

[Disabled] Disables this function.

▶ **Long Duration Power Limit (W) [Auto]**

Sets the long duration TDP power limit for CPU in Turbo Boost mode.

▶ **Long Duration Maintained (s) [Auto]**

Sets the maintaining time for Long duration power Limit(W).

▶ **Short Duration Power Limit (W) [Auto]**

Sets the short duration TDP power limit for CPU in Turbo Boost mode.

▶ **CPU Current Limit (A) [Auto]**

Sets maximum current limit of CPU package in Turbo Boost mode. When the current is over the specified value, the CPU will automatically reduce the core frequency for reducing the current.

▶ **FCLK Frequency [Auto]**

Sets FCLK frequency. Lower FCLK frequency may help you to set higher base clock frequency.

▶ **DMI Link Speed [Auto]**

Sets DMI speed.

## M-Flash Menu

The M-Flash Menu allows you to update BIOS with a USB flash disk.

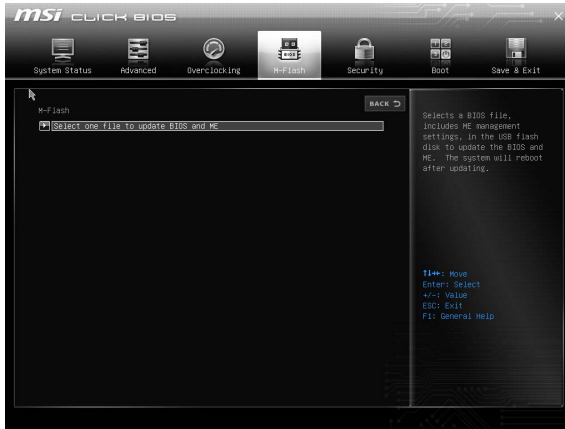

### ► Select one file to update BIOS and ME

Selects a BIOS file, includes the ME management settings, in the USB flash drive to update the BIOS and ME. The system will reboot after updating.

## Security Menu

The Security Menu allows you to set supervisor and user passwords.

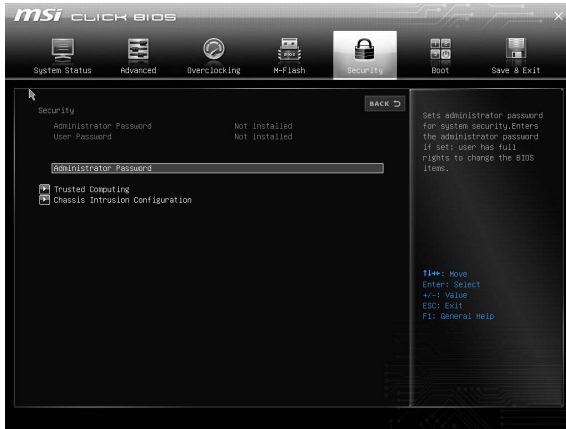

### ► Administrator Password

Sets administrator password for system security. User has full rights to change the BIOS items with administrator password. After setting the administrator password, the state of this item will show “Installed”.

### ► User Password

Sets User Password for system security. User has limited rights to change the BIOS items with user password. This item will be available when administrator password is set. After setting the user password, the state of this item will show “Installed”.

### ► Password Check [Setup]

Selects a condition that will request the password.

[Setup] A password will be requested for entering the BIOS Setup.

[Boot] A password will be requested for booting the system.

### ► Password Clear [Enabled]

Enables or disables the clear CMOS behavior to clear a set password.

[Enabled] The password will be erased after clear CMOS.

[Disabled] The password will always be kept.

## Important

When selecting the Administrator / User Password items, a password box will appear on the screen. Type the password then press <Enter>. The password typed now will replace any previous set password from CMOS memory. You will be prompted to confirm the password. You may also press <Esc> to abort the selection.

To clear a set password, press <Enter> when you are prompted to enter a new password. A message will confirm the password is being disabled. Once the password is disabled, you can enter the setup and OS without authorization.

▶ **Trusted Computing**

Sets TPM (Trusted Platform Module) function.

▶ **Security Device Support [Enabled]**

Enables or disables the TPM function to build the endorsement key for accessing the system.

▶ **TPM Device Selection [PTT]**

Selects TPM device: PTT or dTPM.

[PTT]            Select it for Intel Platform Trust technology

[dTPM]         Select it for installed TPM device.

▶ **Device select [Auto]**

Selects TPM 1.2 or TPM 2.0 technology for installed TPM device. If set to **Auto**, BIOS will detect it automatically.

▶ **Chassis Intrusion Configuration**

Press <Enter> to enter the sub-menu.

▶ **Chassis Intrusion [Disabled]**

Enables or disables recording messages when the chassis is opened. This function is ready for the chassis equips a chassis intrusion switch.

[Enabled]       Once the chassis is opened, the system will record and issue a warning message.

[Reset]         Clear the warning message. After clearing the message, please return to **Enabled** or **Disabled**.

[Disabled]      Disables this function.

## Boot Menu

The Boot Menu allows you to specify the priority of boot devices.

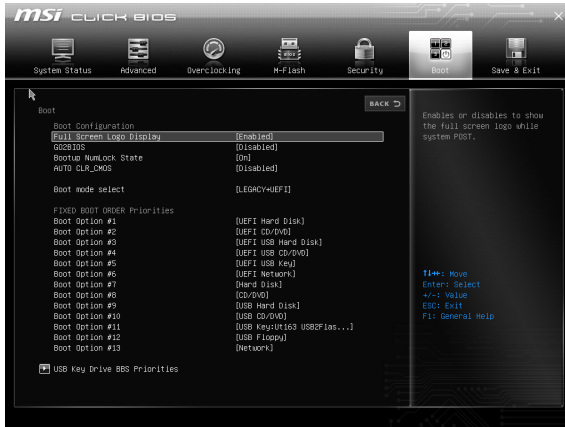

### ► Full Screen Logo Display [Enabled]

Enables or disables to show the full screen logo while system POST.

[Enabled] Shows the logo in full screen.

[Disabled] Shows the POST messages.

### ► GO2BIOS [Disabled]

Allows system to enter BIOS setup directly by pressing the Power button for 4 sec upon bootup.

[Enabled] The system boots straight to the BIOS setup by long pressing the power button about 4 seconds when the system is off.

[Disabled] Disables this function.

### ► Bootup NumLock State [On]

Select the keyboard NumLock state upon bootup.

### ► AUTO CLR\_CMOS [Disabled]

Enables or disables the CMOS data to be resumed automatically when the booting process hang-up over 5 seconds.

### ► Boot Mode Select [LEGACY+UEFI]

Sets the system boot mode from legacy or UEFI architecture depending on OS installation requirement. This item will become un-selectable and will be configured automatically by BIOS when **Windows 8.1/ 10 WHQL Support** is enabled.

[UEFI] Enables UEFI BIOS boot mode support only.

[LEGACY+UEFI] Enables both Legacy BIOS boot mode and UEFI BIOS boot mode.

### ► FIXED BOOT ORDER Priorities

Sets device priority for system boot.

### ► Boot Option Priorities

These items are used to prioritize the installed boot devices.

## Save & Exit Menu

This menu allows you to load the BIOS default values or factory default settings into the BIOS and exit the BIOS setup utility with or without changes.

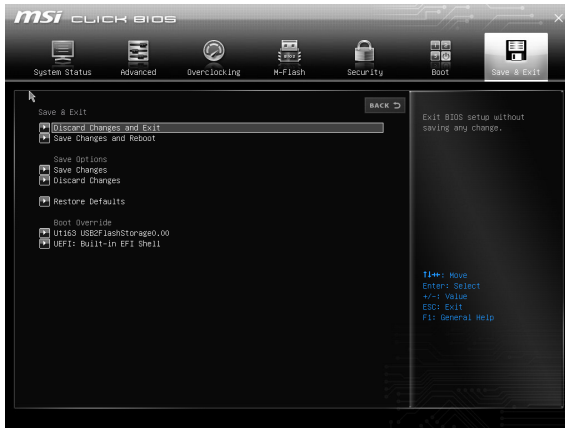

### ▶ Discard Changes and Exit

Exit BIOS setup without saving any change.

### ▶ Save Changes and Reboot

Save all changes and reboot the system.

### ▶ Save Changes

Save current changes.

### ▶ Discard Changes

Discard all changes and restore to the previous values.

### ▶ Restore Defaults

Restore or load all default values.

### ▶ Boot Override

Enter the of EFI Shell screen. The installed boot-able devices will appear on this menu, you can select one of them be the boot device.

# Software Description

## Installing Windows® 7/ 8.1/ 10

1. Power on the computer.
2. Insert the Windows® 7/ 8.1/ 10 disc into your optical drive.  
**Note:** Due to chipset limitation, during the Windows 7 installation process, USB optical drives or USB flash drives are not supported. You can use **MSI Smart Tool** to install Windows® 7.
3. Press the **Restart** button on the computer case.
4. For windows 8.1/ 10, skip this step. For Windows 7, access the BIOS menu **SETTING > Advanced > Windows OS Configuration > Windows 7 Installation** and set the item to enabled, save changes and restart.  
**Note:** It is suggested to plug in your USB Keyboard/ USB Mouse to the leftmost USB port when installing Windows® 7.
5. Press **F11** key during the computer POST (Power-On Self Test) to get into Boot Menu.
6. Select your optical drive from the Boot Menu.
7. Press any key when screen shows **Press any key to boot from CD or DVD...** message.
8. Follow the instructions on the screen to install Windows® 7/ 8.1/ 10.

## Installing Drivers

1. Start up your computer in Windows® 7/ 8.1/ 10.
2. Insert MSI® Driver Disc into your optical drive.
3. The installer will automatically appear and it will find and list all necessary drivers.
4. Click **Install** button.
5. The software installation will then be in progress, after it has finished it will prompt you to restart.
6. Click **OK** button to finish.
7. Restart your computer.

## Installing Utilities

Before you install utilities, you must complete drivers installation.

1. Insert MSI® Driver Disc into your optical drive.
2. The installer will automatically appear.
3. Click **Utilities** tab.
4. Select the utilities you want to install.
5. Click **Install** button.
6. The utilities installation will then be in progress, after it has finished it will prompt you to restart.
7. Click **OK** button to finish.
8. Restart your computer.



## COMMAND CENTER

COMMAND CENTER is an user-friendly software and exclusively developed by MSI, helping users to adjust system settings and monitor status under OS. With the help of COMMAND CENTER, making it possible to achieve easier and efficient monitoring process and adjustments than that under BIOS. In addition, the COMMAND CENTER can be a server for mobile remote control application.



### Profile Buttons



- **Default** - load the default values for the current feature.
- **Apply** - apply your changes.
- **Save** - store values in the file with individual file extension.
- **Load** - load the values from the file.

### Important

Every time you shut down the system, the configured setting will be restored to the factory default. If you want to use the saved settings, you have to load it every time by clicking the **Load** and **Apply** buttons.

### CPU Frequency

CPU Frequency control panel allows you to change CPU Ratio and Base clock. You can see the current frequency of each CPU core on the top of the panel.

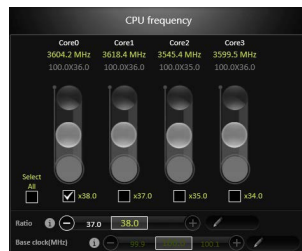

## CPU Fan

CPU Fan control panel provides **Smart mode** and **Manual Mode**. You can switch the control mode by clicking the **Smart Mode** and **Manual Mode** buttons on the top of the CPU Fan control panel.

- **Manual Mode** - allows you to manually control the CPU fan speed by percentage.
- **Smart Mode** - a linear fan speed control feature. The control panel contains 4 dots allows you to drag and adjust the Smart Speed slopes. The fan speed will be changed along these lines with CPU temperature. The white dot will create fan chart in real time.
- **System Fan Button** - to open the system fan control panel in new window.
- **Fan Tune Button** - to automatically optimize the smart fan setting.

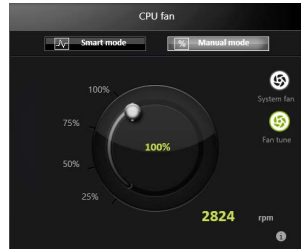

Manual Mode

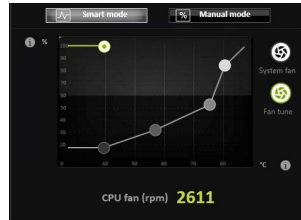

Smart Mode

## CPU Voltage

CPU Voltage control panel allows you to control the CPU voltage.



## DRAM Frequency & DRAM Voltage

- **DRAM Frequency** - Shows the DRAM clock, ratio and frequency.
- **DRAM Voltage** - Allows you to adjust the DRAM voltage. The risky values are displayed in red.

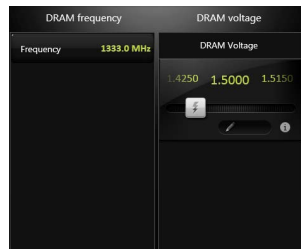

## IGP Frequency & GT Voltage

- **IGP Frequency** - Allows you to adjust the IGP ratio, and shows the IGP clock, ratio and frequency.
- **GT Voltage** - Allows you to adjust the GT voltage. The risky values are displayed in red.

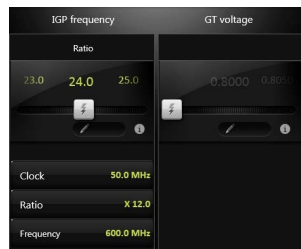

## Option Buttons - Advanced

When click the **Advanced** button, The **Voltage**, **Fan** and **DRAM** icons will appear.



- **Voltage** - allows you to adjust advanced voltage values of CPU and chipset.
- **Fan** - allows you to control the system fans speed.
- **DRAM** - shows the current Advanced DRAM parameters, and allows you to change the settings by selecting values from the drop-down menu on the right hand side.
- **Sensor** - allows you to monitor your motherboard temperature and fan speed with the virtual thermal image. You can drag and drop the fan icons to new locations. When you press the **Cooling** button, all fans will run at full speed.

## Option Buttons - Setting

When click the **Setting** button, The **Record**, **Warning** and **Mobile Control** icons will appear.

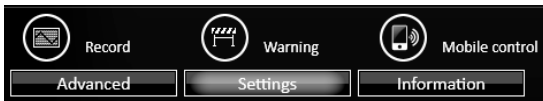

- **Record** - allows you to monitor the status of voltage, fan speed and temperature in real time.
  - To filter record charts, select the check box next to the items.
  - When click the **Play** button, the chart pane will start to show the recording chart. If you want to check the value of a specific spot on chart, please move the orange vertical line to the spot.
  - History Record stores the data and names with date and time.
  - To make a history record: Select items and click the **Record** button. When finished, click the **Record** button again. The data will be stored in the drop-down menu.
  - To load a record, click the drop-down menu and select one from the list.
  - To delete a record, select the record that you want to delete, and click the **Trash Can** icon.
- **Warning** - contains fields of voltage, fan speed and temperature for you to set the threshold values. When system detects the status over your settings, a warning message will pop-up.

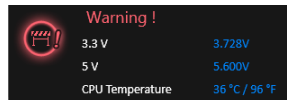

- **Mobile Control** - is only available for the motherboard with the built-in WiFi module. It allows you to enable/disable the COMMAND CENTER Remote Server. Please refer to the instruction on the Mobile Control control panel.

- **To start remote control: (optional)**

1. Download and install **MSI® COMMAND CENTER APP** to your mobile device.
2. Enable **COMMAND CENTER Remote Server** on the **Mobile Control** panel.
3. Enable **SoftAP Management**.
4. Enter **SSID** and **Password**, and then click the **Apply** button.
5. Activate Wi-Fi® on your mobile device and connect to SoftAP with the SSID.
6. Run **MSI® COMMAND CENTER APP** on your mobile device.
7. Find the IP address on the **SoftAP Management Setting** area, and enter the IP address on your **MSI® COMMAND CENTER APP** to link your system.
8. Press **Refresh** on the **MSI® COMMAND CENTER APP** to verify that monitoring and OC functions are working properly.

### Option Buttons - Information

When click the **Information** button, The **Motherboard, CPU, Memory** and **HW monitor** icons will appear.



You can click the icons to open the related information.

### Gadget Mode

COMMAND CENTER provides a gadget mode to monitor the system status. You can switch between gadget mode and full mode by clicking the arrow icon  on the top left.

- **To arrange gadgets:**

1. Click the Spanner icon  on the Gadget mode, a configuration panel will slide out.
2. Select the check box next to the items.
3. Click the **Close** button.

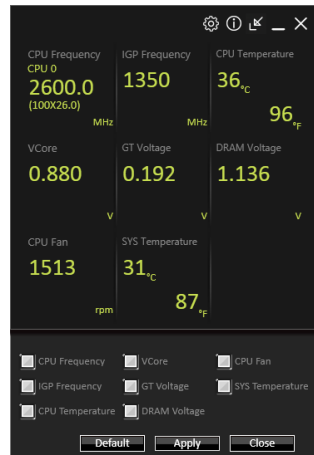

## LIVE UPDATE 6

LIVE UPDATE 6 is an application for the MSI® system to scan and download the latest drivers, BIOS and utilities. With LIVE UPDATE 6, you don't need to search the drivers on websites, and don't need to know the models of motherboard and graphics cards. LIVE UPDATE 6 will download the appropriate drivers automatically.

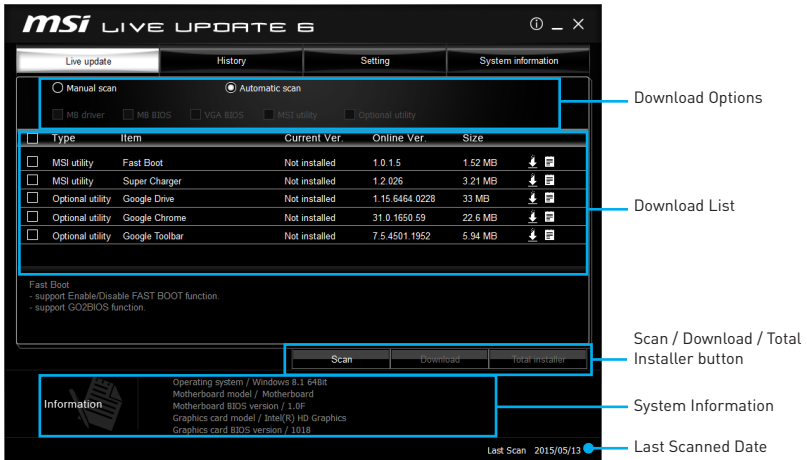

There are **Live Update**, **History**, **Setting** and **System Information** tabs at the top. You can click the tab to switch the control panel.

- **Live Update** - When you launch LIVE UPDATE 6, you will see the Live update tab at first. This tab allows you to select files to download. You can also read the relevant information by clicking the information icon  on the right of the item listed.
- **History** - shows the downloading history.
- **Setting** - allows you to specify the frequency that LIVE UPDATE 6 remind you to update.
- **System Information** - displays the information of the system.

## Updating The System

This section describes how to update your system with LIVE UPDATE 6. Please follow the steps below:

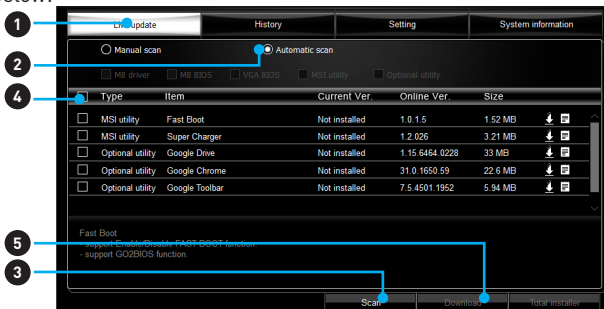

1. Select the **Live Update** tab.

- Choose **Automatic scan**, system will automatically scan all the items and search for the latest update files. Or you can choose **Manual scan** and select the items you wish to scan.
- Click the **Scan** button at the bottom. It may take several moments to complete the process.
- When the download list appears, please select the items you intend to update.
- Click **Download** button at the bottom.
- When **Save Path** prompt, you can specify a download directory.

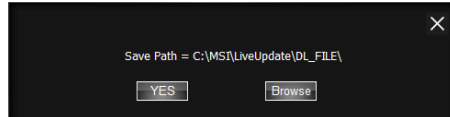

- When downloading you will see the screen below. It may take several moments to complete the process.

Type	Item	Latest Ver.	Size	Download
MSI utility	Fast Boot	1.0.1.5	1.52 MB	<div style="width: 46%;"></div> 46 %
MSI utility	Super Charger	1.2.026	3.21 MB	

- To install the applications, simply unpack the packages and install.

## Total Installer

Total Installer is a convenient feature to simplify frequent installing procedure. To use Total Installer:

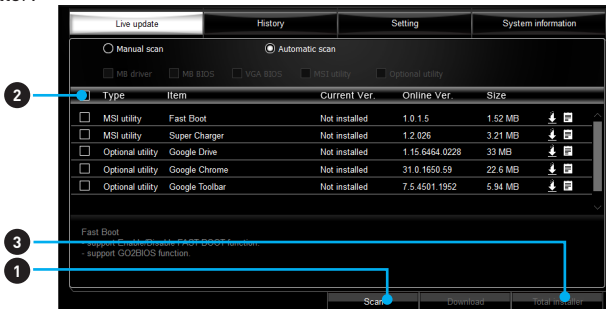

- Scan** updates in **Live Update** tab.
- Check the **Select All** check-box you intend to update.
- Click the **Total Installer** button. LIVE UPDATE 6 will automatically install them.
- When prompted, click **OK** to complete the Total Installer procedure
- Reboot your system.

## GAMING APP

GAMING APP is an application designed to quickly control your system for improving gaming performance.

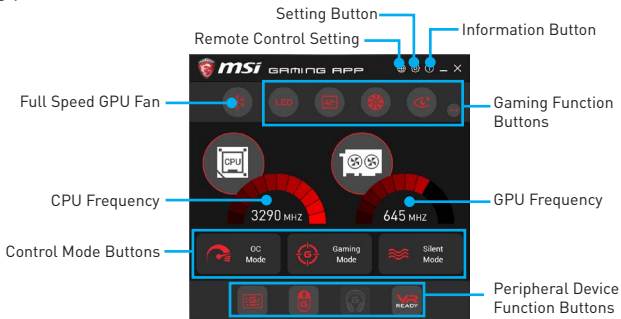

- **Setting Button** - allows you to run GAMING APP when Windows starts.
  - **Information Button** - shows the information of this application.
  - **CPU Frequency** - shows the current CPU frequency.
  - **Control Mode Buttons**
    - **OC Mode** - enables Game Boost function to automatically overclock the CPU.
    - **Gaming Mode** - automatically optimize the CPU ratio and the GPU clock.
    - **Silent Mode** - reverts the CPU ratio and GPU clock to the default values.
  - **Gaming Function Buttons** - allows you to use **LED Effect**, **OSD**, **Eye Rest** and **Dragon Eye** functions.
  - **Peripheral Device Function Buttons** - allows you to set the **Gaming Hotkey**, **Mouse Master** and **VR Ready** functions.
  - **Remote Control Setting** - is only available for the motherboard with the built-in WiFi module or with an external WiFi home router. It allows you to set up a set of **Name** and **Password** to link the android device the motherboard. Please refer to the following instructions to complete the remote control setting.
1. Download and install the **MSI® GAMING APP** APP to your android device.
  2. Set up a set of **Name** and the **Password** on the **Remote Control Setting** panel, and then click the **Apply** button.
  3. Activate Wi-Fi® on your android device and connect it to the wireless network of the motherboard.
  4. Run **MSI® GAMING APP** APP on your android device.
  5. Press the **Remote Control Setting** icon on the **MSI® GAMING APP** APP to find the paired device **Name** you set on the **Remote Control Setting** panel.
  6. Enter the **Password** you set on the **Remote Control Setting** panel.0
  7. Finally, you can use the **MSI® GAMING APP** APP to control the aspect of your motherboard with the android device.

## OSD Setting Panel

Use the OSD setting panel to specify information within on-screen display (OSD).

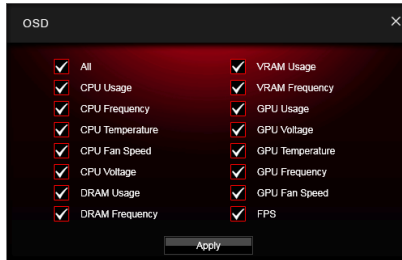

- **Apply Button** - allows you to accept selections.

## Eye Rest

Eye Rest allows you to optimize the display on your monitor.

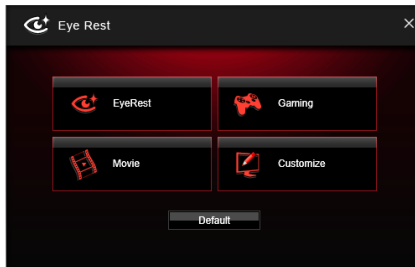

- **EyeRest** - reduces blue-light of your LED backlit screen, in order to protect your eyes.
- **Gaming** - automatically increase contrast ratio of your screen.
- **Movie** - automatically increase dynamic contrast ratio of your screen.
- **Customize** - allows you to adjust gamma, contrast and color balance for your screen.
- **Default** - loads the default settings.



## VR Ready

VR Ready can automatically detect VR devices connected to the system. When enabled, it can provide the right advice to make sure your system is VR Ready.

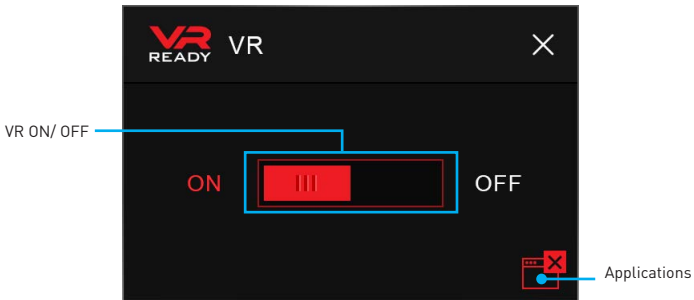

- **VR ON/ OFF** - enables or disables VR device support.
- **Applications** - appears when you turn on the VR support. It allows you to close some applications to optimize the system for better VR experience.

## Mouse Master

Mouse Master provides mouse macro function. You can also use it to change DPI of your mouse.



- **Delay Time** - allows you to input delay time and click the **Add** button to insert a delay in the macro.
- **Macro Hot Key** - allows you to assign a hotkey from A to Z to activate the macro.
- **Mouse Action** - assigns mouse actions to the macro.
  - **New** - captures the mouse coordinate and add to the macro.
  - **Left** - add a left-click to the macro.
  - **Middle** - add a middle-click to the macro.
  - **Right** - add a right-click to the macro.
- **Action List** - shows the actions of the current macro.
- **Edit Buttons** - there 3 buttons for editing the macro.
  - **Run** - activates the macro.
  - **Delete** - removes the selected action from the macro.
  - **Clear** - removes all actions from the macro.
- **Load Button** - allows you to load a macro.
- **Save Button** - allows you to save the macro to a file.
- **DPI Setting** - allows you select the mouse DPI from the drop-down menu.
- **Default Button** - reverts to the default DPI setting.
- **DPI Hot Key** - allows you to assign a hotkey from A to Z to activate the DPI setting. Please note that you must hold the hotkey to keep the DPI setting. When you release the hotkey, the DPI setting will be reverted to default.
- **Test Area** - allows you to test the mouse movement.
- **Clear Button** - clears the test area.

# RAMDISK

RAMDISK creates a virtual RAM drive using the available memory in your computer, the performance of the RAMDISK is faster than an SSD and hard drive. RAMDISK allows you to store any temporary information on it. Furthermore, using the RAMDISK will extend your SSD's life by sparing it from excessive reading and writing.

## Creating a RAM Disk

When **RAMDISK** is started, it will create a default RAM disk. If you want to change settings, refer to following instructions.

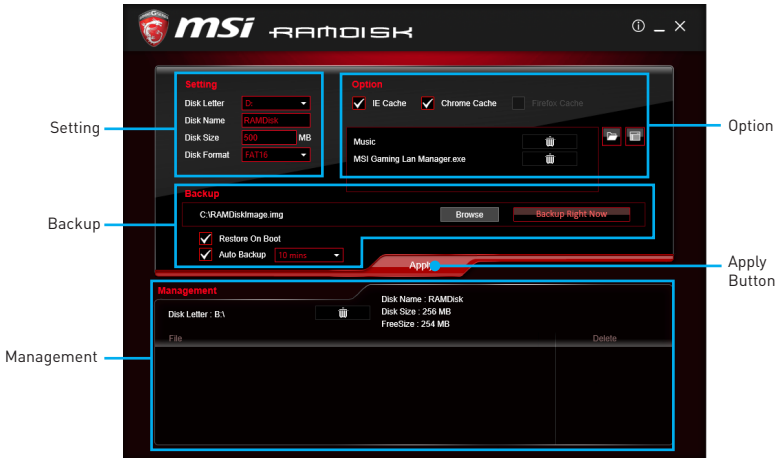

- **Setting** - specify **Letter, Name, Size** and **Format** of the RAM disk.
- **Option** - select browser temporary files to save/load on the RAM disk. You can also add software files to improve reading speed.
- **Backup** - specify backup and restore settings to prevent data loss. All files will be lost each time the RAMDISK is stopped if you do not backup.
  - **Browse Button** - set the path to the image file.
  - **Backup Right Now Button** - manually backup files.
  - **Restore On Boot** - check this box to have the image file loaded automatically when RAMDISK starts.
  - **Auto Backup** - check this box to backup automatically over a period of time.
- **Apply Button** - allows you to apply changes.
- **Management** - shows RAMDISK information and allows you to delete files.

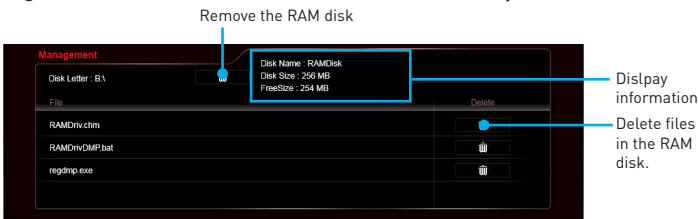

## GAMING LAN MANAGER

GAMING LAN MANAGER is an utility for traffic shaping for the Windows 7/ 8.1/ 10. It can keep your internet fast during heavy upload/ download and improve your ping for online games. If your motherboard has a Wi-Fi module, GAMING LAN MANAGER provides virtual access point function for traffic shaping for your mobile devices.

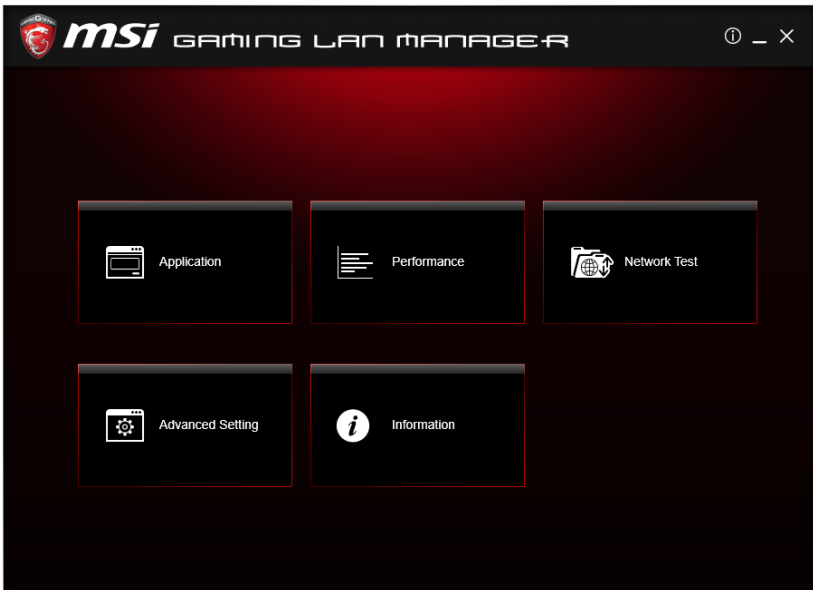

- **Applications** - displays currently using network bandwidth applications. You can prioritize Games, Medias or File sharing programs as high as possible.
- **Performance** - shows top 5 applications by total traffic, allows you to monitor network bandwidth usage.
- **Network Test** - allows you to setup bandwidth control.
- **Advanced Setting** - allows you to expand RWIN to accelerate download speed. You can also block IP address and setup virtual access point.
- **Information** - shows version information.

### Configuring Bandwidth

This section describes how to configure Internet Provider Speed. You can configure default internet upload and download bandwidth from the Network Test tab on the GAMING LAN MANAGER window.

#### **Important**

*Before using the GAMING LAN MANAGER for the first time, you should use the **Test Network Speed** button which runs a speed test of your current total Internet bandwidth delivered through your Internet service provider.*

## Speed Testing

The speed testing is used to optimize bandwidth usage. To test the Upload and Download speed, please follow the steps below:

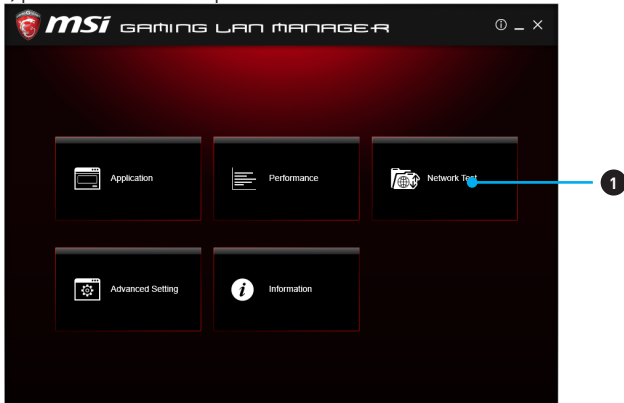

1. Click the **Network Test** block in GAMING LAN MANAGER.

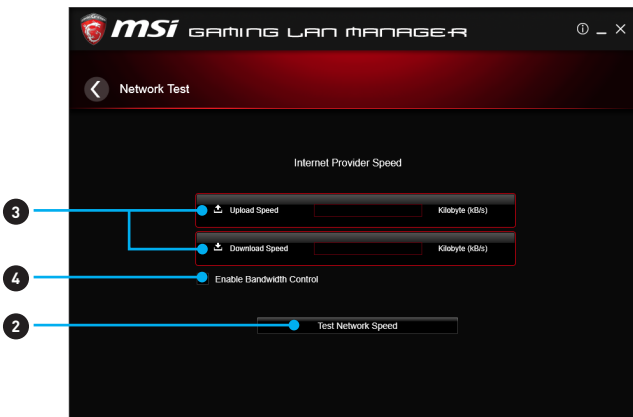

2. Click **Test Network Speed** button. The test takes several minutes to test your network speed.
3. Enter the testing results into **Upload Speed** and **Download Speed** fields.
4. Check the **Enable Bandwidth Control** to allow the GAMING LAN MANAGER to manage the bandwidth.

## DRAGON EYE

DRAGON EYE is an application that allows you to watch a game guide, tutorial, live match or tournament stream while playing a game. In the game, you can use hotkeys to control / adjust the window of video.

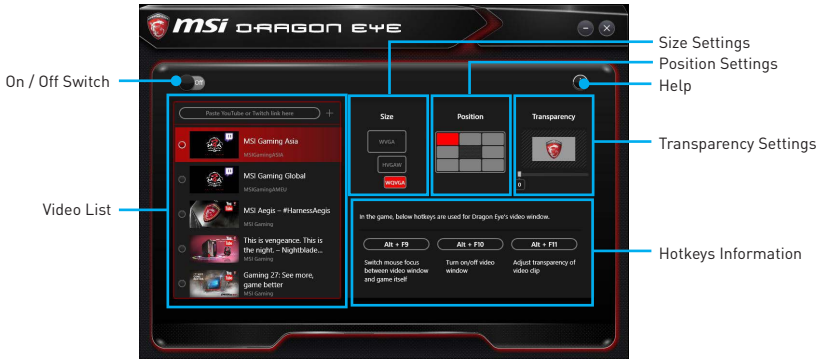

- **On / Off Switch** - enables or disables Dragon Eye during your gaming sessions. Switch it on before you launch the game in order to watch video while playing.
- **Video List** - allows you to select the video you want to watch, and also add videos or channels to the list. You simply paste the URL of your video or stream into the input bar and hit the +. Then your video or stream will be in the list and you can select it to view it with Dragon Eye.
- **Size Settings** - allows you to select the size of the Dragon Eye video content displayed on-screen when you're playing a game. There are three options available:
  - WQVGA (Small – 400 × 240)
  - HVGA (Medium – 640 × 360)
  - WVGA (Large – 768 × 480)
- **Position Settings** - allows you to select where the Dragon Eye video needs to be displayed on screen. This way you can control where you want your video in-game, so you can place it on a place where no important game information is.
- **Help** - If you want to watch the video tutorial for Dragon Eye or want to see if your game is supported, press this button and the help window will be shown.
- **Transparency Settings** - allows you to set the transparency of your Dragon Eye video.
  - 0 = opaque | 100 = transparent.
- **Hotkeys Information** - In this information screen you can find the hotkeys for Dragon Eye. There are three hotkeys:
  - **Alt+F9** - switches mouse focus between video window and game itself. (Direct interface to adjust progress bar, volume and other settings of video during the game)
  - **Alt+F10** - turns on/off video window .
  - **Alt+F11** - adjusts transparency of video clip.

**NOTE:** To customize hotkey, simply select the hotkey icon and then press the keys combination you want to use as a hotkey.

# Intel® Extreme Tuning Utility

Intel® Extreme Tuning Utility (Intel XTU) is a simple overclocking software for you to tune, test and monitor your system.

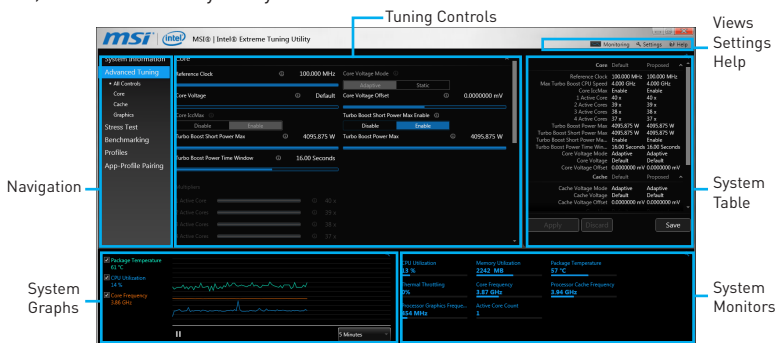

## Views Settings Help

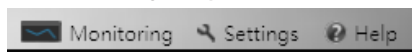

- **Views** - toggles to switch between **Monitoring** and **Show All** view.
- **Settings** - opens the **General Settings** window.
- **Help** - displays the help content for Intel XTU in a separate window.
- **Navigation** - lists all of the major functions of Intel XTU.
  - **System Information** - shows the details about your system.
  - **App-Profile Pairing** - tunes automatically based on active application.
  - **Manual Tuning** - changes system settings in a free form.
  - **Stress Test** - tests the stability of your system.
  - **Benchmarking** - analyzes and compares your system's performance against other system profiles.
  - **Profiles** - manages sets of system settings.
- **Tuning Controls** - displays the controls for changing the system settings in manual tuning. For stress tests and profiles, this area displays the settings for these features.
- **System Table** - displays information about the current system settings and a summary of your changes.
- **System Graphs** - shows measured system values over a period of time. The system graphs update live as changes are detected in the system. You can customize the system graphs to show the data you need for your overclocking strategy in the system graphs preferences.
- **System Monitors** - shows the range of the value, averages, and the current value. The monitors change color if the monitored values fall into warning or critical zones.

## SteelSeries Engine 3

SteelSeries Engine 3 is a unified platform built to support all of SteelSeries products. It can deploy your saved device settings automatically when switching between your favorite games or applications.

After installation the SteelSeries Engine background processes will start and the interface will open automatically.

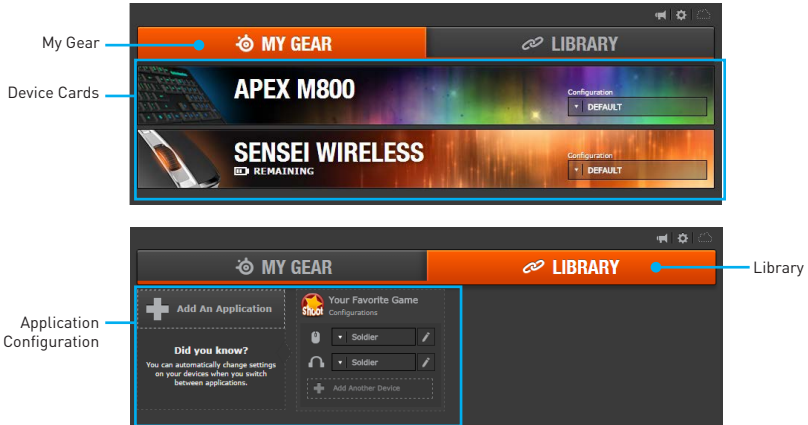

- **My Gear** - all of your SteelSeries devices in one place.
  - **Device Cards** - all of your SteelSeries devices are easily accessible from the My Gear tab, regardless of type, connection status, or which applications they are assigned to.
- **Library** - quickly set up your configurations to autolaunch with an application.
  - **Application Configuration** - you can choose to have configurations deploy automatically whenever you use a specific game or application. Add any number of applications to your library and SteelSeries Engine 3 will seamlessly change the configurations of your devices as you switch between them.

## Configuration Windows

Configuration Windows are unique to their devices and each of them includes a collapsible **Configuration List Panel** of all the configurations for that device. You can create a new configuration by selecting the **New** button at the bottom of the Configuration List Panel.

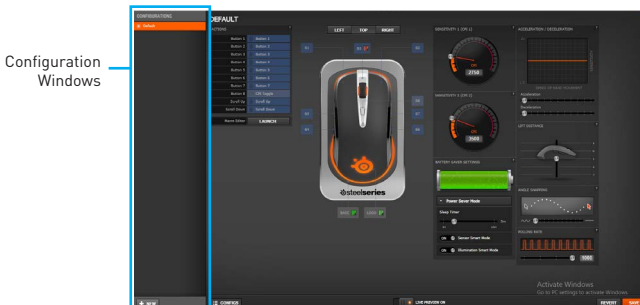



## Configuring Your Devices

You can custom configurations for SteelSeries devices in their Configuration Windows. The top left displays the name of the configuration you are viewing, the body features widgets for customizing various functions of the device, and at the bottom are Save/ Revert buttons, a Live Preview toggle, and a button to open/close the collapsible Configuration List Panel.

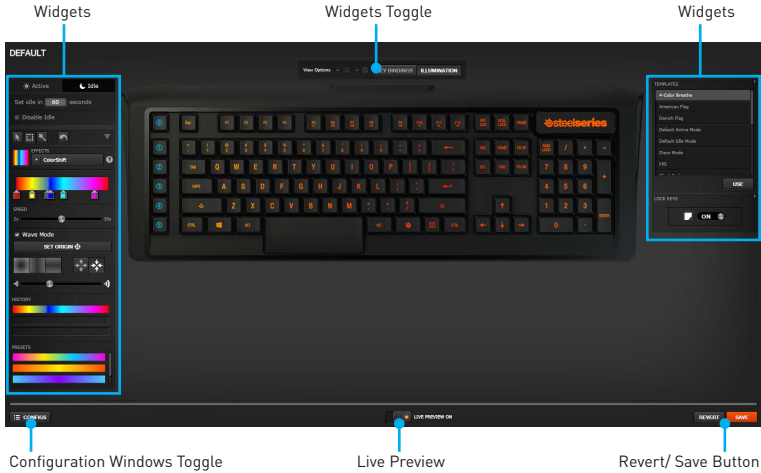

- **Widgets** - allow you to customize a certain aspect of your device.
- **Widgets Toggle** - allows you to toggle Widgets .
- **Configuration Windows Toggle** - allows you to toggle the Configuration Windows.
- **Live Preview** - gives you the full experience of your configuration's look, feel, and sound while you are editing it.
- **Revert/ Save Button** - configuration changes are not written to the database until you select **Save**. This gives you freedom to experiment, knowing that you can select **Revert** to undo changes.

## Tool Tip

When you click the question mark next to a feature name on the panel, a tooltip will show, describing the particular function of that item.

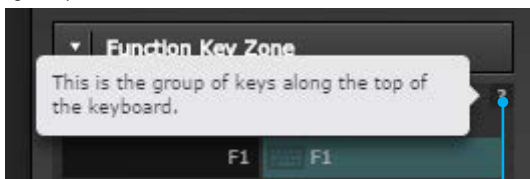

Question Mark

## CPU-Z

CPU-Z is a utility that gathers information on some of the main devices of your system.

**CPU-Z** - X

**CPU** Caches Mainboard Memory SPD Graphics Bench About

**Processor**

Name	Intel Core i5 6400		
Code Name	Skylake	Max TDP	65.0 W
Package	Socket 1151 LGA		
Technology	14 nm	Core Voltage	0.752 V

**Specification** Intel(R) Core(TM) i5-6400 CPU @ 2.70GHz (ES)

Family	6	Model	E	Stepping	3
Ext. Family	6	Ext. Model	5E	Revision	R0

**Instructions** MMX, SSE, SSE2, SSE3, SSSE3, SSE4.1, SSE4.2, EM64T, VT-x, AES, AVX, AVX2, FMA3

**Clocks (Core #0)**

Core Speed	798.2 MHz
Multiplier	x 8.0 (8 - 33)
Bus Speed	99.8 MHz
Rated FSB	

**Caches**

L1 Data	4 x 32 KBytes	8-way
L1 Inst.	4 x 32 KBytes	8-way
Level 2	4 x 256 KBytes	4-way
Level 3	6 MBytes	12-way

**Selection** Processor #1 Cores 4 Threads 4

Version 1.75.0 Validate OK

- **CPU Tab** - shows processor name, code name, package, specification, instructions sets, core speed and cache levels.
- **Caches Tab** - shows extended information related to the cache capabilities.
- **Mainboard Tab** - shows motherboard manufacturer, model name, chipset, BIOS version and graphic interface.
- **Memory Tab** - shows memory type, memory size, channels, memory frequency.
- **SPD Tab** - shows specifications relating to each memory module connected to the motherboard, including the size, type and frequency.
- **Graphics Tab** - shows GPU name, code name, core speed, memory size, and memory type.
- **Bench Tab** - allows you to run either a benchmark or a stress test on your processor.
- **About Tab** - shows the CPU-Z version, Windows version, DirectX version and allows you to save the report file.

# RAID Configuration (optional)

Below are the different types of a RAID.

- RAID 0** breaks the data into blocks which are written to separate hard drives. Spreading the hard drive I/O load across independent channels greatly improves I/O performance.
- RAID 1** provides data redundancy by mirroring data between the hard drives and provides enhanced read performance.
- RAID 5** provides data striping at the byte level and also stripe error correction information. This results in excellent performance and good fault tolerance.
- RAID 10** uses four hard drives to create a combination of RAID 0 and 1 by forming a RAID 0 array from two RAID 1 arrays.

## RAID level comparison

	RAID 0	RAID 1	RAID 5	RAID 10
Minimum # drives	2	2	3	4
Data protection	None	Excellent	Excellent	Excellent
Read performance	Excellent	OK	Good	OK
Write performance	Excellent	Good	OK	Good
Capacity utilization	100%	50%	67%~(1-1/n)	50%

## Using Intel® Rapid Storage Technology Option ROM

First, you need to set the **SATA mode** to **RAID** in BIOS to create, delete and reset RAID volumes. To enter the IRST Option ROM, reboot and press **Ctrl + I** keys to enter the IRST Option ROM during the POST, the following window will appear.

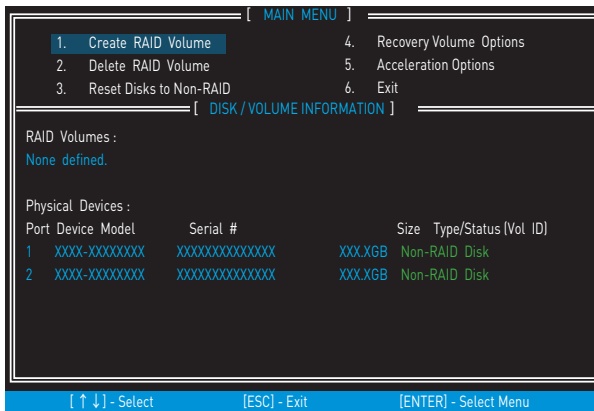

### Important

The following procedure is only available with a newly-built system or if you are reinstalling your OS. It should not be used to migrate an existing system to RAID.

## Creating RAID Volume

1. Select option **Create RAID Volume** and press **Enter** key. The following screen appears.

```
[ CREATE VOLUME MENU ]
Name : Volume0
RAID Level : RAID1[Mirror]
Disks : Select Disks
Strip Size : N / A
Capacity : XXX.X GB
Sync : N / A
Create Volume

[ HELP ]

RAID 1 : Mirrors data (redundancy).

[ ↑ ↓ ] - Change [ TAB ] - Next [ ESC ] - Previous Menu [ ENTER ] - Select
```

2. Specify a RAID Volume name and then press the **Tab** or **Enter** key to go to the next field
3. Use the **↑ ↓ ← →** arrow keys to select the RAID level best suited to your usage model in RAID Level.
4. In the Disk field, press **Enter** key and use **Space** key to select the disks you want to create for the RAID volume, then click **Enter** key to finish selection. This field will become available according to the selected RAID level.
5. Select the strip size for the RAID array by using the **↑ upper arrow** or **↓ down arrow** keys to scroll through the available values, and pressing the **Enter** key to select and advance to the next field. The available values range from 4KB to 128 KB in power of 2 increments. The strip size should be chosen based on the planned drive usage. Here are some typical values:  
RAID0 -128KB / RAID10 - 64KB / RAID5 - 64KB.
6. Select the capacity of the volume in the **Capacity** field. The default value is the maximum volume capacity of the selected disks.



### **Important**

*Since you want to create two volumes, this default size (maximum) needs to be reduced. Type in a new size for the first volume. As an example: if you want the first volume to span the first half of the two disks, re-type the size to be half of what is shown by default. The second volume, when created, will automatically span the remainder of two hard drives.*

7. Go to the **Create Volume** field and press **Enter**, a WARNING message will appear for you to confirm if you are sure to create the RAID volume. Press **Y** to continue.

## Delete RAID Volume

Here you can delete the RAID volume, but please be noted that all data on RAID drives will be lost.



*If your system currently boots to RAID and you delete the RAID volume in the IRST Option ROM, your system will become unbootable.*

Select option **Delete RAID Volume** from the main menu screen and press **Enter** key to select a RAID volume for deletion. Then press **Delete** key to delete the selected RAID volume. The following screen appears.



Press **Y** key to accept the volume deletion.

## Reset Disks to Non-RAID

Select option **Reset Disks to Non-RAID** from the main menu screen and press **Enter** to delete the RAID volume and remove any RAID structures from the drives. Use the **Space** key to select the disks and press **Enter** key. A confirmation sentence will appear below, and then press **Y** key to accept the selection

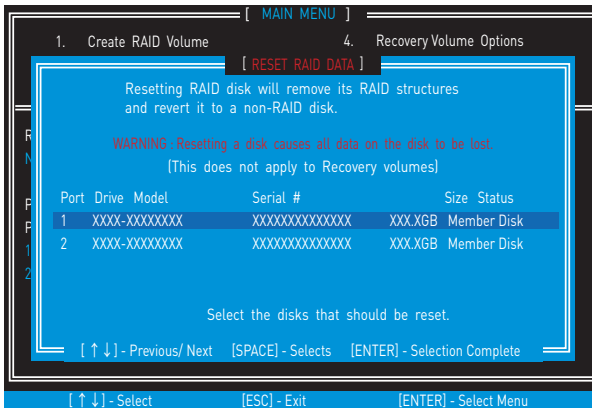

## Important

- You will lose all data on the RAID drives and any internal RAID structures when you perform this operation.
- Possible reasons to **Reset Disks to Non-RAID** could include issues such as incompatible RAID configurations or a failed volume or failed disk.

## Recovery Volume Options

Select option **Recovery Volume Options** from the main menu screen and press **Enter** to change recovery volume mode. The following screen appears:



Recovery mode will change from Continuous Update to On-Request after you enable **Only Recovery Disk** or **Only Master Disk**.

## Degraded RAID Array

A RAID 1, RAID 5 or RAID 10 volume is reported as degraded when one of its hard drive members fails or is temporarily disconnected, and data mirroring is lost. As a result, the system can only utilize the remaining functional hard drive member. To re-establish data mirroring and restore data redundancy, refer to the procedure below that corresponds to the current situation.

RAID Volumes						
ID	Name	Level	Strip	Size	Status	Bootable
0	Volume0	RAID 1(Mirror)	N/A	XXX.XGB	Degraded	Yes

Physical Disks:				
Port	Device Model	Serial #	Size	Type/Status(Vol ID)
1	XXXXXXXXXXXXXX	XXXXXXXXXXXXXX	XXX.XGB	Member Disk (0)
2	XXXXXXXXXXXXXX	XXXXXXXXXXXXXX	XXX.XGB	Member Disk (0)

Press <CTRL-I> to enter Configuration Utility..

## Missing Hard Drive Member

1. Power off.
2. Reconnect the hard drive.

3. Reboot to Windows®; the rebuild will occur automatically.

## Failed Hard Drive Member

1. Power off.
2. Replace the failed hard drive with a new one that is of equal or greater capacity.
3. Reboot the system to IRST Option ROM by press **Ctrl + I** keys during the POST.
4. Select the port of the destination disk for rebuilding, and then press **Enter**.

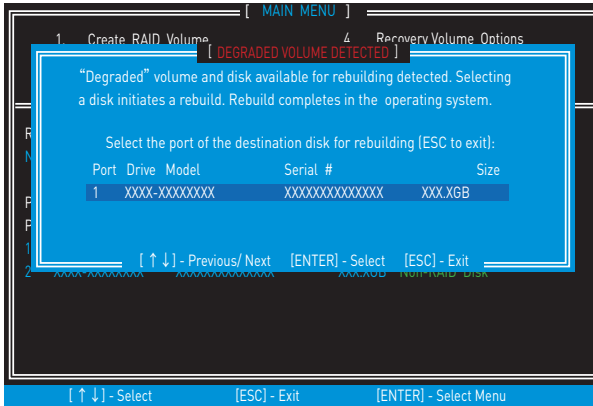

5. Exit IRST Option ROM, reboot to Windows®.
6. When prompted to rebuild the RAID volume, click **Yes**.
7. The **Intel® Rapid Storage Technology** application will be launched. Right-click the new hard drive and select **Rebuild to this Disk**. The **Rebuild Wizard** will be launched which will guide you through the process of rebuilding to the new hard drive.

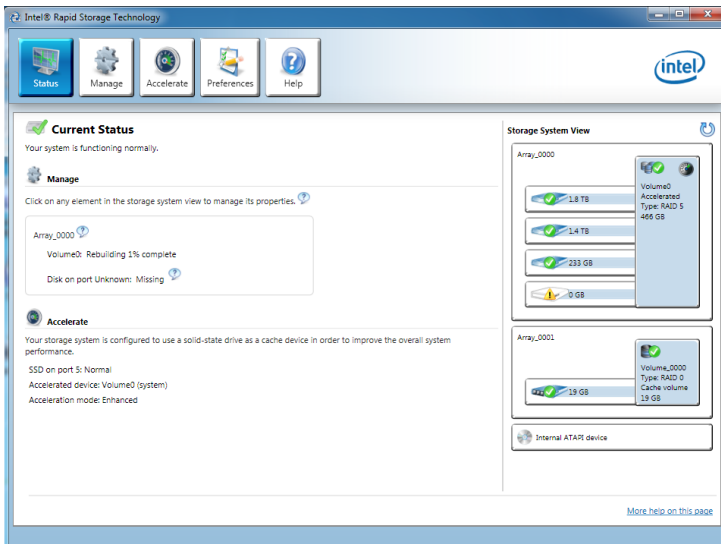

# Troubleshooting

Before sending the motherboard for RMA repair, try to go over troubleshooting guide first to see if your got similar symptoms as mentioned below.

## The power is not on.

- Connect the AC power cord to an electrical outlet securely.
- Check if all ATX power connectors like **ATX\_PWR1**, **CPU\_PWR1** are connected from the power supply to the motherboard?
- Some power supply units have a power button on the rear side, make sure the button is turned on.
- Check if the power switch cable is connected to **JFP1** pin header properly.
- Verify the **Clear CMOS** jumper **JBAT1** is set to **Keep DATA**.
- Test with another known working power supply of equal or greater wattage.

## The power is on, but no signal to monitor

- Connect the monitor power cord to a electrical outlet securely.
- Make sure the monitor is turned on.
- Select different inputs on the monitor.
- If 3 long beeps are heard, remove all memory modules and try to install only one memory module in the **DIMMA2** slot first and then restart the computer.
- If 1 long 2 short beeps are heard, remove and reinstall the graphics card and then restart the computer.
- Test with another known working graphics card.

## The computer does not boot after updating the BIOS

- Clear the CMOS.
- Use the secondary BIOS to bootup the system (Only for motherboard with Dual BIOS)

## Lost BIOS password

- Clear the CMOS, but that will cause you to lose all customized settings in the BIOS.

## There is no audio

- Adjust the volume.
- Connect the speakers/headphones to audio ports on the motherboard rear IO panel.
- Remove secondary speakers/headphones, HDMI cables, USB audio devices.
- Test with another known working speaker or headphone.

## There is no network

- Make sure the network chipset driver has been installed.
- Verify if the network cable is properly connected and make sure the LAN port LEDs are properly illuminated.
- Verify your TCP/IP settings.
- Restart or reset your router.
- Test with another known working LAN cable.

## The USB device is not working

- Make sure your USB drive driver has been installed.
- Verify if USB device is listed in Windows® Device Manager.
- Connect the USB device to other USB port on the motherboard rear IO panel.



# Regulatory Notices

## FCC Compliance Statement

Note: This equipment has been tested and found to comply with the limits for a Class B digital device, pursuant to part 15 of the FCC Rules. These limits are designed to provide reasonable protection against harmful interference in a residential installation. This equipment generates, uses and can radiate radio frequency energy and, if not installed and used in accordance with the instructions, may cause harmful interference to radio communications. However, there is no guarantee that interference will not occur in a particular installation. If this equipment does cause harmful interference to radio or television reception, which can be determined by turning the equipment off and on, the user is encouraged to try to correct the interference by one or more of the following measures:

- Reorient or relocate the receiving antenna.
- Increase the separation between the equipment and receiver.
- Connect the equipment into an outlet on a circuit different from that to which the receiver is connected.
- Consult the dealer or an experienced radio/TV technician for help.

Caution: Changes or modifications not expressly approved by the party responsible for compliance could void the user's authority to operate the equipment.

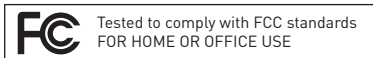

This device complies with part 15 of the FCC Rules. Operation is subject to the following two conditions:  
(1) This device may not cause harmful interference, and  
(2) this device must accept any interference received, including interference that may cause undesired operation.

## CE Conformity

 Hereby, Micro-Star International CO., LTD declares that this device is in compliance with the essential safety requirements and other relevant provisions set out in the European Directive.

## C-Tick Compliance



## B급 기기 (가정용 방송통신기자재)

 이 기기는 가정용(B급) 전자파적합기기로서 주 로 가정에서 사용하는 것을 목적으로 하며, 모든 지역에서 사용할 수 있습니다.

## クラスB情報技術装置

 この装置は、クラスB情報技術装置です。この装置は、家庭環境で使用することを目的としていますが、この装置がラジオやテレビジョン受信機に近接して使用されると、受信障害を引き起こすことがあります。取扱説明書に従って正しい取り扱いをして下さい

VCCI-B

## Battery Information

European Union:



Batteries, battery packs, and accumulators should not be disposed of as unsorted household waste. Please use the public collection system to return, recycle, or treat them in compliance with the local regulations.

Taiwan:



廢電池請回收

For better environmental protection, waste batteries should be collected separately for recycling or special disposal.

California, USA:



The button cell battery may contain perchlorate material and requires special handling when recycled or disposed of in California.

For further information please visit:

<http://www.dtsc.ca.gov/hazardouswaste/perchlorate/>

CAUTION: There is a risk of explosion, if battery is incorrectly replaced.  
Replace only with the same or equivalent type recommended by the manufacturer.

## Chemical Substances Information

In compliance with chemical substances regulations, such as the EU REACH Regulation (Regulation EC No. 1907/2006 of the European Parliament and the Council), MSI provides the information of chemical substances in products at:  
[http://www.msi.com/html/popup/csr/evmtprtt\\_pcm.html](http://www.msi.com/html/popup/csr/evmtprtt_pcm.html)

## WEEE (Waste Electrical and Electronic Equipment) Statement

### ENGLISH

To protect the global environment and as an environmentalist, MSI must remind you that...

Under the European Union ("EU") Directive on Waste Electrical and Electronic Equipment, Directive 2002/96/EC, which takes effect on August 13, 2005, products of "electrical and electronic equipment" cannot be discarded as municipal wastes anymore, and manufacturers of covered electronic equipment will be obligated to take back such products at the end of their useful life. MSI will comply with the product take back requirements at the end of life of MSI-branded products that are sold into the EU. You can return these products to local collection points.



### DEUTSCH

Hinweis von MSI zur Erhaltung und Schutz unserer Umwelt

Gemäß der Richtlinie 2002/96/EG über Elektro- und Elektronik-Altgeräte dürfen Elektro- und Elektronik-Altgeräte nicht mehr als kommunale Abfälle entsorgt werden. MSI hat europaweit verschiedene Sammel- und Recyclingunternehmen beauftragt, die in die Europäische Union in Verkehr gebrachten Produkte, am Ende seines Lebenszyklus zurückzunehmen. Bitte entsorgen Sie dieses Produkt zum gegebenen Zeitpunkt ausschliesslich an einer lokalen Altgerätesammelstelle in Ihrer Nähe.

### FRANÇAIS

En tant qu'écologiste et afin de protéger l'environnement, MSI tient à rappeler ceci... Au sujet de la directive européenne (EU) relative aux déchets des équipements électriques et électroniques, directive 2002/96/EC, prenant effet le 13 août 2005, que les produits électriques et électroniques ne peuvent être déposés dans les décharges ou tout simplement mis à la poubelle. Les fabricants de ces équipements seront obligés de récupérer certains produits en fin de vie. MSI prendra en compte cette exigence relative au retour des produits en fin de vie au sein de la communauté européenne. Par conséquent vous pouvez retourner localement ces matériels dans les points de collecte.

### РУССКИЙ

Компания MSI предпринимает активные действия по защите окружающей среды, поэтому напоминаем вам, что... В соответствии с директивой Европейского Союза (ЕС) по предотвращению загрязнения окружающей среды использованным электрическим и электронным оборудованием [директива WEEE 2002/96/ЕС], вступающей в силу 13 августа 2005 года, изделия, относящиеся к электрическому и электронному оборудованию, не могут рассматриваться как бытовой мусор, поэтому производители вышеперечисленного электронного оборудования обязаны принимать его для переработки по окончании срока службы. MSI обязуется соблюдать требования по приему продукции, проданной под маркой MSI на территории ЕС, в переработку по окончании срока службы. Вы можете вернуть эти изделия в специализированные пункты приема.

### ESPAÑOL

MSI como empresa comprometida con la protección del medio ambiente, recomienda: Bajo la directiva 2002/96/EC de la Unión Europea en materia de desechos y/o equipos electrónicos, con fecha de rigor desde el 13 de agosto de 2005, los productos clasificados como "eléctricos y equipos electrónicos" no pueden ser depositados en los contenedores habituales de su municipio, los fabricantes de equipos electrónicos, están obligados a hacerse cargo de dichos productos al término de su periodo de vida. MSI estará comprometido con los términos de recogida de sus productos vendidos en la Unión Europea al final de su periodo de vida. Usted debe depositar estos productos en el punto limpio establecido por el ayuntamiento de su localidad o entregar a una empresa autorizada para la recogida de estos residuos.

### NEDERLANDS

Om het milieu te beschermen, wil MSI u eraan herinneren dat...

De richtlijn van de Europese Unie (EU) met betrekking tot Vervuiling van Electricische en Electronische producten (2002/96/EC), die op 13 Augustus 2005 in zal gaan kunnen niet meer beschouwd worden als vervuiling. Fabrikanten van dit soort producten worden verplicht om producten retour te nemen aan het eind van hun levenscyclus. MSI zal overeenkomstig de richtlijn handelen voor de producten die de merknaam MSI dragen en verkocht zijn in de EU. Deze goederen kunnen geretourneerd worden op lokale inzamelingspunten.

### SRPSKI

Da bi zaštitili prirodnu sredinu, i kao proizvođač koje vodi računa o okolini i prirodnoj sredini, MSI mora da vas podesti da... Po Direktivi Evropske unije ("EU") o odbačenoj elektonskoj i električnoj opremi, Direktiva 2002/96/EC, koja stupa na snagu od 13. Avgusta 2005, proizvođači koji spadaju pod "elektronsku i električnu opremu" ne mogu više biti odbačeni kao običan otpad i proizvođači ove opreme biće prinudeni da uzmu natrag ove proizvode na kraju njihovog uobičajenog veka trajanja. MSI će poštovati zahtev o preuzimanju ovakvih proizvoda kojima je istekao vek trajanja, koji imaju MSI oznaku i koji su prodati u EU. Ove proizvode možete vratiti na lokalnim mestima za prikupljanje.

### POLSKI

Aby chronić nasze środowisko naturalne oraz jako firma dbająca o ekologię, MSI przypomina, że... Zgodnie z Dyrektywą Unii Europejskiej ("UE") dotycząca odpadów produktów elektrycznych i elektronicznych (Dyrektywa 2002/96/EC), która wchodzi w życie 13 sierpnia 2005, tzw. "produkty oraz wyposażenie elektryczne i elektroniczne" nie mogą być traktowane jako śmieci komunalne, tak więc producenci tych produktów będą zobowiązani do odbierania ich w momencie gdy produkt jest wycofywany z użycia. MSI wypełni wymagania UE, przyjmując produkty [sprzedawane na terenie Unii Europejskiej] wycofywane z użycia. Produkty MSI będzie można zwracać w wyznaczonych punktach zbiorczych.

## TÜRKÇE

Çevreci özelliğiyle bilinen MSI dünyada çevreyi korumak için hatırlatır:  
Avrupa Birliği (AB) Kararnamesi Elektrik ve Elektronik Malzeme Atığı, 2002/96/EC Kararnamesi altında 13 Ağustos 2005 tarihinden itibaren geçerli olmak üzere, elektrikli ve elektronik malzemeler diğer atıklar gibi çöpe atılmayacak ve bu elektronik cihazların üreticileri, cihazların kullanın süreleri bittikten sonra ürünleri geri toplamakla yükümlü olacaktır. Avrupa Birliği'ne satılan MSI markalı ürünlerin kullanın süreleri bittiğinde MSI ürünlerin geri alınması isteği ile işbirliği içerisinde olacaktır. Ürünlerinizi yerel toplama noktalarına bırakabilirsiniz.

## ČESKY

Záleží nám na ochraně životního prostředí - společnost MSI upozorňuje...

Podle směrnice Evropské unie ("EU") o likvidaci elektrických a elektronických výrobků 2002/96/EC platné od 13. srpna 2005 je zakázáno likvidovat "elektrické a elektronické výrobky" v běžném komunálním odpadu a výrobci elektrických výrobků, na které se tato směrnice vztahuje, budou povinni odebírat takové výrobky zpět po skončení jejich životnosti. Společnost MSI splní požadavky na odebrání výrobků značky MSI, prodávaných v zemích EU, po skončení jejich životnosti. Tyto výrobky můžete odevzdat v místních sběrnách.

## MAGYAR

Annak érdekében, hogy környezetünk megvédjük, illetve környezetvédekként fellépve az MSI emlékezteti Önt, hogy ...  
Az Európai Unió („EU”) 2005. augusztus 13-án hatályba lépő, az elektromos és elektronikus berendezések hulladékairól szóló 2002/96/EK irányelve szerint az elektromos és elektronikus berendezések többé nem kezelhetőek lakossági hulladékként, és az ilyen elektronikus berendezések gyártói kötelesek válnak az ilyen termékek visszavételére azok hasznos élettartama végén. Az MSI betartja a termékviszavétellel kapcsolatos követelményeket az MSI márkanév alatt az EU-n belül értékesített termékek esetében, azok élettartamának végén. Az ilyen termékeket a legközelebbi gyűjtőhelyre viheti.

## ITALIANO

Per proteggere l'ambiente, MSI, da sempre amica della natura, ti ricorda che...  
In base alla Direttiva dell'Unione Europea (EU) sullo Smaltimento dei Materiali Elettrici ed Elettronici, Direttiva 2002/96/EC in vigore dal 13 Agosto 2005, prodotti appartenenti alla categoria dei Materiali Elettrici ed Elettronici non possono più essere eliminati come rifiuti municipali: i produttori di detti materiali saranno obbligati a ritirare ogni prodotto alla fine del suo ciclo di vita. MSI si addeguerà a tale Direttiva ritirando tutti i prodotti marchiati MSI che sono stati venduti all'interno dell'Unione Europea alla fine del loro ciclo di vita. È possibile portare i prodotti nel più vicino punto di raccolta

## 日本JIS C 0950材質宣言

日本工業規格JIS C 0950により、2006年7月1日以降に販売される特定分野の電気および電子機器について、製造者による含有物質の表示が義務付けられます。  
[http://www.msi.com/html/popup/csr/cemm\\_jp.html](http://www.msi.com/html/popup/csr/cemm_jp.html)  
[http://tw.msi.com/html/popup/csr\\_tw/cemm\\_jp.html](http://tw.msi.com/html/popup/csr_tw/cemm_jp.html)

## India RoHS

This product complies with the "India E-waste (Management and Handling) Rule 2011" and prohibits use of lead, mercury, hexavalent chromium, polybrominated biphenyls or polybrominated diphenyl ethers in concentrations exceeding 0.1 weight % and 0.01 weight % for cadmium, except for the exemptions set in Schedule 2 of the Rule.

## Türkiye EEE yönetmeli 7

Türkiye Cumhuriyeti: EEE Yönetmeli ine Uygundur

## Україна обмеження на наявність небезпечних речовин

Обладнання відповідає вимогам Технічного регламенту щодо обмеження використання деяких небезпечних речовин в електричному та електронному обладнанні, затвердженого постановою Кабінету Міністрів України від 3 грудня 2008 № 1057.

## Việt Nam RoHS

Kể từ ngày 01/12/2012, tất cả các sản phẩm do công ty MSI sản xuất tuân thủ Thông tư số 30/2011/TT-BCT quy định tạm thời về giới hạn hàm lượng cho phép của một số hóa chất độc hại có trong các sản phẩm điện, điện tử"

## Environmental Policy

- The product has been designed to enable proper reuse of parts and recycling and should not be thrown away at its end of life.
- Users should contact the local authorized point of collection for recycling and disposing of their end-of-life products.
- Visit the MSI website and locate a nearby distributor for further recycling information.
- Users may also reach us at [gpcontdev@msi.com](mailto:gpcontdev@msi.com) for information regarding proper Disposal, Take-back, Recycling, and Disassembly of MSI products.



## 产品中有害物质的名称及含量

部件名称	有害物质					
	铅 (Pb)	汞 (Hg)	镉 (Cd)	六价铬 [Cr(VI)]	多溴联苯 (PBB)	多溴二苯醚 (PBDE)
印刷电路板组件*	X	0	0	0	0	0
电池** 	X	0	0	0	0	0
外部信号连接头	X	0	0	0	0	0
线材	X	0	0	0	0	0

本表格依据 SJ/T 11364 的规定编制。

0: 表示该有害物质在该部件所有均质材料中的含量均在 GB/T 26572 规定的限量要求以下。

X: 表示该有害物质至少在该部件的某一均质材料中的含量超出 GB/T 26572 规定的限量要求, 但所有部件都符合欧盟 RoHS 要求。

\* 印刷电路板组件: 包括印刷电路板及其构成的零部件。

\*\* 电池本体上如有环保使用期限标识, 以本体标识为主。

■ 上述有毒有害物质或元素清单会依型号之部件差异而有所增减。

■ 产品部件本体上如有环保使用期限标识, 以本体标识为主。

## Copyright

**msi** Micro-Star Int'l Co., Ltd.  
Copyright © 2016 All rights reserved.

The material in this document is the intellectual property of Micro-Star Int'l Co., Ltd. We take every care in the preparation of this document, but no guarantee is given as to the correctness of its contents. Our products are under continual improvement and we reserve the right to make changes without notice.

## Technical Support

If a problem arises with your system and no solution can be obtained from the user guide, please contact your place of purchase or local distributor. Alternatively, please try the following help resources for further guidance.

- Visit the MSI website for technical guide, BIOS updates, driver updates, and other information: <http://www.msi.com>
- Register your product at: <http://register.msi.com>

## Trademark Recognition

All product names used in this manual are the properties of their respective owners and are acknowledged.

## Revision History

Version 1.0, 2016/10, First release.