



Manufacturer: Yi Technology Co., Ltd
Address: Building 18, NO 55, Chuanhe Road, Shanghai China

Email:
supportus@yitechnology.com (North America)
support-eu@yitechnology.com (Europe & UK)
supportasia@yitechnology.com (Asia Pacific)
support@yitechnology.com (others)

Website: www.yitechnology.com
<https://www.yitechnology.com/legal/privacy-policy>

Y621 EU V2.1

Thank you for choosing the YI Home 2K Pro Camera

Table of Contents

1. English	1
2. Français	7
3. Deutsch	13
4. Español	19
5. Italiano	25
6. Русский	31

1. What's in the box

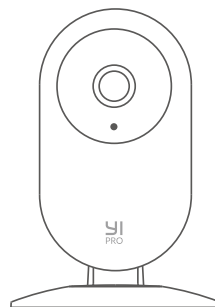

Yi Home 2K Pro Camera x1



USB Cable x1



Manual x1



Adaptor x1

2. Get to know the Camera

Note: To enable local recording of video clip, please insert a microSD card* (not included) to the slot as shown below.

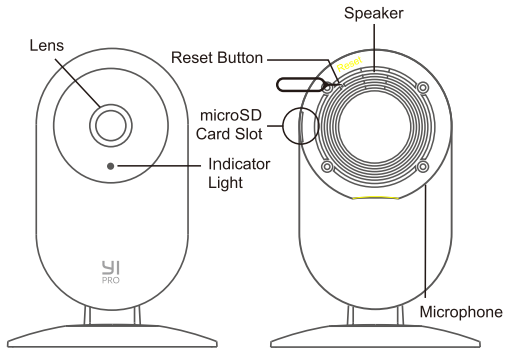

2

3. Pairing Your Camera

Prerequisite:

- Ensure that your cell phone is connected to a 2.4 GHz Wi-Fi network.
- Download the YI Home app from the Apple App Store or Google Play.
- Register a YI account or log on to an existing YI account.

Step 1

Connect the power adapter to an outlet to activate the camera. The camera indicator will flash red and you will hear the introductory message "Welcome to YI home", followed by "Waiting to connect". When you hear "waiting to connect", tap "I heard waiting to connect".

Note: To install a camera that was previously installed on a different network or if you change your password, you must reset your camera.

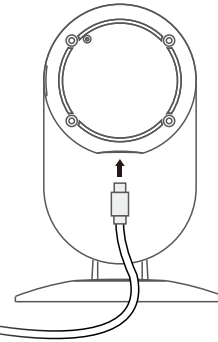

3

Step 2

Log into the YI Home App, you can tap the "+" sign to select your device or scan the camera's QR code with your phone.

Step 3

Enter the password of the same Wi-Fi network that is connected to your phone, then use the YI Home 2K Pro Camera to scan the QR code that will be generated.

Step 4

Tap "Next Step". You will hear "Pairing is successful" and then the YI Home 2K Pro Camera is ready to use.

4. Reset Wi-Fi Networks

When you need to switch Wi-Fi networks or update your Wi-Fi password, follow the instructions below:

1. Restore your camera to its default settings by pressing the reset button.
2. Open the YI Home app on your phone, and connect the camera to your phone again. Your videos stored on your microSD card will not be affected.



5. Specifications

Max Resolution: 2304 x 1296 (2K)

Lens: Wide-Angle

Audio: Built-in Microphone and Speaker

Alert Modes: Motion Detection, Sound Detection, (subscribe only:
Person Detection, Vehicle Detection, Animal Detection)

Wi-Fi: 802.11b/g/n, 2.4GHz

Support: Android, iOS

Power Supply: 5V 1A

Power Consumption: 3.5 W (Max)

Operating Temperature: -10°C to 50°C (14°F to 122°F)

1. Contenu de la boîte



Caméra YI Home 2K Pro x1 +



Câble USB x1



Manuel x1

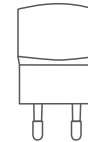

Adapter x1

2. Apprenez à connaître votre appareil photo

Remarque: Pour activer l'enregistrement local du clip vidéo, veuillez insérer une carte microSD* (non incluse) dans la fente comme indiqué ci-dessous.

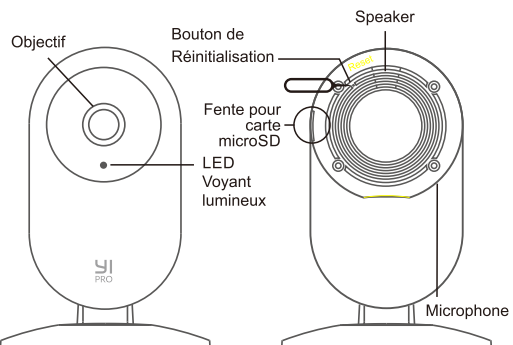

8

3. Jumelage de votre caméra

Prérequis:

- Assurez-vous que votre téléphone portable est connecté à un réseau Wi-Fi 2,4 GHz.
- Téléchargez l'application YI Home depuis l'App Store d'Apple ou Google Play.
- Enregistrez un compte personnel YI ou connectez-vous à un compte YI existant.

Etape 1

Connectez l'adaptateur secteur à une prise pour activer la caméra. L'indicateur de l'appareil photo clignotera en jaune et vous entendrez le message d'introduction «Bienvenue chez YI Home», suivi de «En attente de connexion». Lorsque vous entendez "En attente de connexion", appuyez sur "I heard waiting to connect".

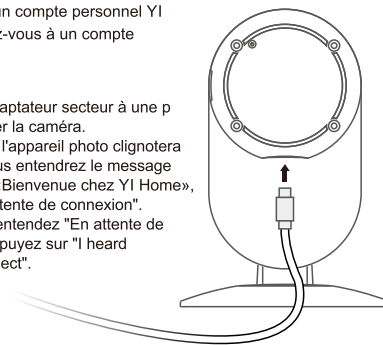

9

Remarque: pour installer une caméra précédemment installée sur un autre réseau ou si vous modifiez votre mot de passe, vous devez réinitialiser votre caméra.

Étape 2

Connectez-vous à l'accueil de l'application YI, vous pouvez appuyer sur le signe «+» pour sélectionner votre appareil ou scanner le code QR.

Étape 3

Entrez le mot de passe du même réseau Wi-Fi qui est connecté à votre téléphone, puis utilisez la caméra panoramique YI Home 2K Pro pour scanner le code QR.

Étape 4

Appuyez sur «Étape suivante». Vous entendrez «Le couplage est réussi», puis la caméra panoramique YI Home 2K Pro est prête à être utilisée.

4. Changer de réseau Wi-Fi

Lorsque vous devez changer de réseau Wi-Fi ou mettre à jour votre mot de passe Wi-Fi, suivez les instructions ci-dessous:

1. Utilisez le clip livré avec la caméra pour la réinitialiser.
2. Ouvrez l'application YI Home sur votre téléphone et reconnectez l'appareil photo à votre téléphone. Vos vidéos stockées sur votre carte MicroSD ne seront pas affectées.



5. Paramètres

Résolution maximale: 2304 x 1296 (2K)

Objectif: Grand angle

Audio: Mic/Haut-parleur intégrés

Mode d'alerte: Détection de mouvement, détection sonore, (S'abonner uniquement: détection de personne, détection de véhicule, détection d'animaux)

Wi-Fi: 802. 11b/g/n, 2.4 G Hz

Plate-forme de support: Android, iOS

Alimentation en énergie: DC5V1A

Consommation: 5W (Max)

Plage de fonctionnement -10°C to 50°C

1. Im Lieferumfang

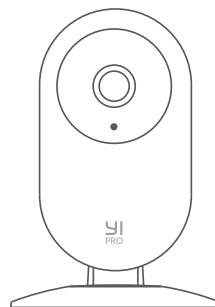

YI Home 2K Pro Kamera x1



Cable USB x1



Handbuch x1



Adapter x1

2. Inbetriebnahme

Hinweis: Um die lokale Aufnahme von Videoclips zu ermöglichen, legen Sie bitte eine microSD-Karte* (nicht im Lieferumfang enthalten) wie unten gezeigt in den Steckplatz ein.

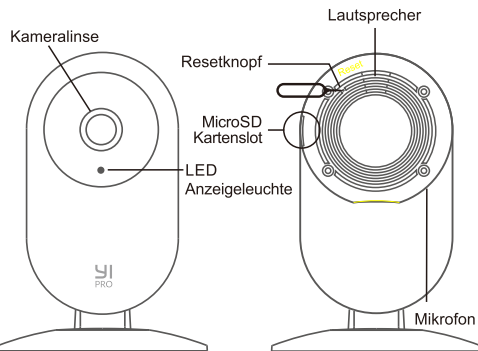

14

3. Kamera koppeln

Voraussetzung:

- Vergewissern Sie sich, dass Ihr Mobiltelefon mit einem 2,4-GHz-WLAN-Netz verbundenen ist.
- Laden Sie die YI Home-App aus dem Apple App Store oder von Google Play herunter.
- Registrieren Sie ein YI Home-Konto oder melden Sie sich bei einem bestehenden YI-Konto an.

Schritt 1

Schließen Sie das Netzteil an einer Steckdose an, um die Kamera zu aktivieren. Die Anzeige der Kamera blinkt gelb und Sie hören die einleitende Meldung "Welcome to YI Home", gefolgt von "Waiting to connect". Wenn Sie "Waiting to connect" hören, tippen Sie auf "I heard waiting to connect".

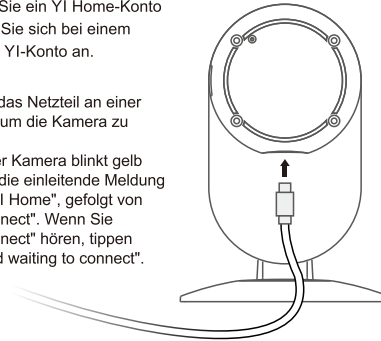

15

Hinweis: Um eine Kamera zu installieren, die zuvor in einem anderen Netzwerk installiert wurde oder wenn Sie Ihr Kennwort ändern, müssen Sie Ihre Kamera zurücksetzen.

Schritt 2

Melden Sie sich bei der YI Home-App an, tippen Sie auf "+", um Ihr Gerät auszuwählen oder scannen Sie den QR-Code.

Schritt 3

Geben Sie das Passwort des WLAN-Netzwerks ein, mit dem Ihr Telefon verbunden ist und verwenden Sie dann die YI Home 2K Pro Kamera für Innenräume, um den QR-Code zu scannen.

Schritt 4

Tippen Sie auf "Nächster Schritt". Sie hören "Pairing is successful" und die YI Home 2K Pro ist einsatzbereit.

4. WLAN wechseln

Wenn Sie das Netzwerk wechseln möchten, gehen Sie bitte wie folgt vor:

1. Benutzen Sie beigelegte Nadel um die Mini-Kamera zurückzusetzen.
2. Öffnen Sie die YI Home App und verbinden Sie die Kamera erneut. Videos auf der Speicherkarte bleiben erhalten.



5. Spezifikationen

Maximale Auflösung: 2304 x 1296 (2K)

Objektiv: Weitwinkel

Audio: Eingebautes Mikrofon / Lautsprecher, Gegensprechfunktion

Alarmmodi: Bewegungserkennung, Geräuscherkennung, (Nur abonnieren: Personenerkennung, Fahrzeugerkennung, Tiererkennung)

WLAN: 2.4GHz, 802.11 bgn

Betriebssysteme: Android / iOS

Stromversorgung: Gleichstrom 5 V / 1 A

Energieverbrauch: 5W (max.)

Betriebstemperatur: -10°C to 50°C

1. Contenido de la caja

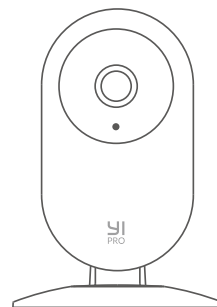

Cámara de vigilancia
YI Home 2K Pro x1



Cable USB x1



Manual x1



Adaptador x1

2. Conoce la cámara

Nota: Para habilitar la grabación local de un videoclip, inserte una tarjeta microSD * (no incluida) en la ranura como se muestra a continuación.

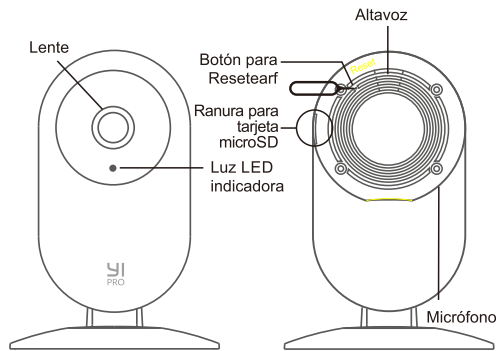

20

3. Emparejar la cámara

Requisitos previos:

- Asegúrese de que su teléfono esté conectado a una red Wi-Fi de 2,4 GHz.
- Descargue la aplicación YI Home desde Apple App Store o Google Play.
- Registre una cuenta de inicio de YI o inicie sesión con una cuenta de YI existente.

Paso 1

Conecte el adaptador de corriente a una toma de corriente para activar la cámara. El indicador de la cámara parpadeará en amarillo y escuchará el mensaje introductorio "Bienvenido a YI Home", seguido de "Esperando para conectar". Cuando escuche "esperando para conectar", toque "escuché esperando para conectar".

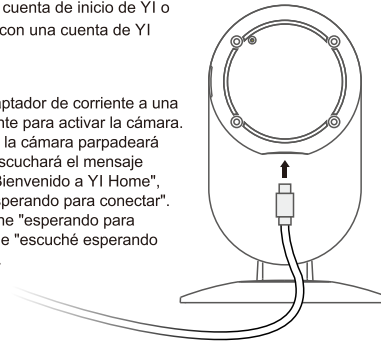

21

Nota: Para instalar una cámara que se instaló previamente en una red diferente o si cambia su contraseña, deberá restablecer su cámara. Pulse el botón de reinicio que se encuentra en la parte inferior de la cámara.

Paso 2

Inicie sesión en la aplicación YI Home, puede tocar el signo "+" para seleccionar su dispositivo o escanear el código QR.

Paso 3

Introduzca la contraseña de la misma red Wi-Fi que está conectada a su teléfono, a continuación, use la cámara YI Home 2K Pro para escanear el código QR.

Paso 4

Toque "Siguiendo paso". Escuchará "El emparejamiento se realizó correctamente" y, a continuación, la cámara YI Home 2K Pro estará lista para usarse.

4. Cambiar la red Wi-Fi

Cuando necesite cambiar las redes Wi-Fi o actualizar su contraseña de Wifi, siga las instrucciones a continuación:

1. Use un clip para presionar el botón de reinicio en la parte posterior de la cámara y espere hasta que se encienda la luz amarilla.
2. Abra la aplicación YI Home en su teléfono y conecte la cámara a su teléfono nuevamente. Sus videos almacenados en su tarjeta MicroSD no se verán afectados.

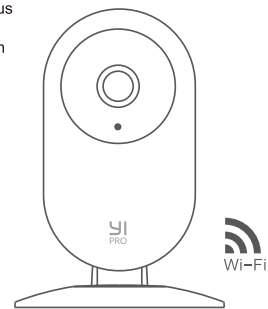

5. Parámetros básicos

Resolución máxima: 2304 x 1296 (2K)

Objetivo: Gran angular

Audio: Micrófono integrado / Altavoz

Modos de alerta: Detección de movimiento, detección de sonido,
(Solo suscribirse: detección de personas, detección de vehículos,
detección de animales)

Wi-Fi: 802. 11b/g/n, 2.4 G Hz

Plataformas compatibles: Android, iOS

Rango de operación: DC 5V / 1A

Consumo: 5W (Max)

Temperatura di esercizio: -10°C - 50°C

1. Contenido della confezione



Camera di sorveglianza
Yi Home 2K Pro x1



Cavo USB x1



Manuale x1

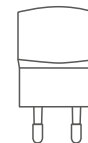

Adattatore x1

2. Componenti della telecamera

Nota: Per abilitare la registrazione locale del videoclip, inserire una scheda microSD* (non inclusa) nello slot come mostrato di seguito.

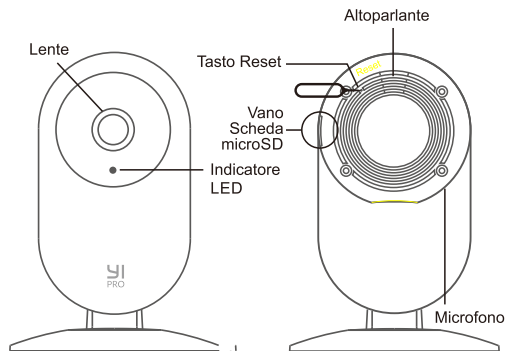

26

3. Associazione della telecamera

Prerequisiti:

- Assicurarsi che il telefono cellulare sia collegato a una rete Wi-Fi a 2.4 GHz.
- Scaricare l'app YI Home da Apple App Store o Google Play.
- Registrare un account YI Home o accedere a un account YI esistente.

Fase 1

Collegare l'alimentatore a una presa per attivare la telecamera. L'indicatore della fotocamera lampeggerà in giallo e sentirai il messaggio introduttivo "Welcome to YI Home" (Benvenuto in YI Home), seguito da "Waiting to connect" (In attesa di connessione). Se sentirai "Waiting to connect", premi il pulsante "Ho Sentito Waiting to connect".



27

Nota: per abbinare ad una nuova rete wifi una telecamera precedentemente abbinata ad un'altra rete, oppure in caso di modifica della password, sarà necessario resettare la telecamera.

Fase 2

Accedere all'app YI Home, è possibile toccare il segno "+" per selezionare il dispositivo o scansionare il QR code.

Fase 3

Inserire la password della stessa rete Wi-Fi a cui è collegato il telefono, quindi utilizzare la telecamera YI Home 2K Pro per scansionare il QR code.

Fase 4

Toccare "Next Step" (Fase successiva). Si udirà "Pairing is successful" (Associazione riuscita) e la telecamera YI Home 2K Pro è pronta per l'uso.

4. Cambiare rete Wifi

Quando è necessario cambiare rete Wi-Fi o aggiornare la password Wifi, seguire le istruzioni che seguono:

1. Utilizzare una clip per premere il tasto reset sulla base della fotocamera ed attendere fino all'accensione della luce gialla.
2. Accedere alla app YI Home dal proprio telefono, cancellare la telecamera dalla App ed abbinarla nuovamente. I video eventualmente salvati sulla scheda MicroSD non verranno cancellati.

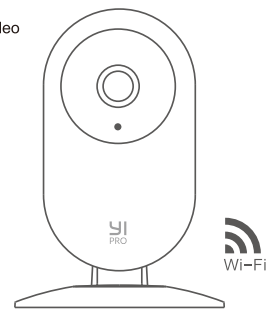

5. Specifiche tecniche

Risoluzione Max: 2304 x 1296 (2K)

Lente: Grandangolo con zoom digitale 4x

Audio: Microfono / altoparlante integrati

Modalità di allarme: Rilevamento del movimento, rilevamento del suono, (solo per iscritto: rilevamento di persone, rilevamento di veicoli, rilevamento di animali)

Wi-Fi: 802. 11b/g/n, 2.4 G Hz

Piattaforme supportate: Android, iOS

Alimentazione: DC 5V / 1A

Consumo di energia: 5W (Max)

Temperatura di esercizio: -10°C ~ 50°C

1. Комплектация

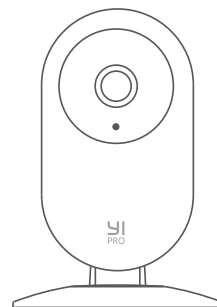

Камера видеонаблюдения
YI Home 2K Pro x 1



Кабель
USB x 1



Инструкция
пользователя x 1



Адаптер x 1

2. Знакомство с камерой

Примечание: чтобы активировать локальную запись видеоклипов, вставьте карту памяти Micro-SD (не входит в комплект) в разъем, как показано ниже.

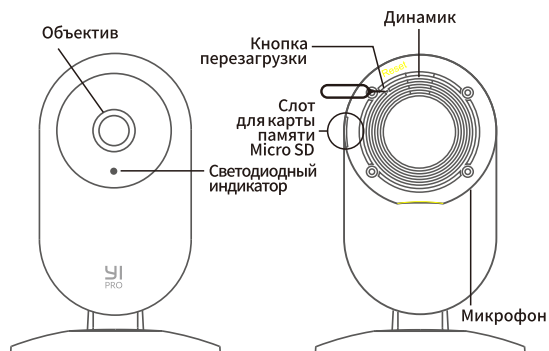

32

3. Синхронизация камеры

Перед началом работы:

- Убедитесь, что ваш смартфон подключен к сети Wi-Fi 2,4 ГГц.
- Загрузите приложение YI Home из Apple App Store или Google Play.
- Зарегистрируйте учетную запись YI или войдите в существующую учетную запись YI.

Шаг 1

Подключите адаптер питания к розетке, чтобы активировать камеру. Индикатор камеры будет мигать желтым, и вы услышите "Welcome to YI Home, waiting to connect", затем коснитесь «I heard waiting to connect».

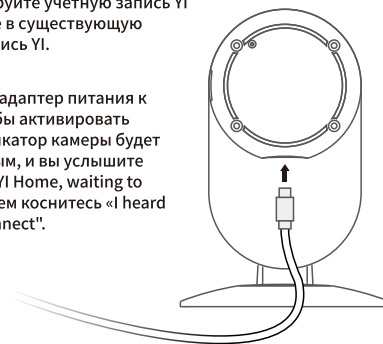

33

Примечание: для подключения камеры к другой сети Wi-Fi или для изменения пароля, пожалуйста, перезагрузите камеру кнопкой "reset".

Шаг 2

Войдите в приложение Yi Home, вы можете нажать на знак «+», чтобы выбрать свое устройство или отсканировать QR-код.

Шаг 3

Введите пароль той же сети Wi-Fi, к которой подключен ваш смартфон, затем выберите камеру Yi Home 2K Pro для сканирования QR-кода.

Шаг 4

Нажмите «Next Step». Вы услышите «Pairing is successful», и затем ваша камера Yi Home 2K Pro готова к использованию.

4. Переключение сетей Wi-Fi

Если вам нужно переключить сети Wi-Fi или обновить свой пароль Wi-Fi, следуйте приведенным ниже инструкциям:

1. С помощью скрепки нажмите кнопку сброса на задней панели камеры и подождите, пока не загорится желтый индикатор.
2. Откройте приложение Yi Home на телефоне и снова подключите камеру к телефону. Ваши видео, хранящиеся на вашей карте MicroSD, не будут повреждены или удалены.



5. Технические характеристики

Максимальное разрешение: 2304 x 1296 (2K)

Объектив: широкоугольный

Аудио: встроенный микрофон/динамик

Режимы оповещения: Обнаружение движения, обнаружение звука, (только подписка: обнаружение человека, обнаружение транспортного средства, обнаружение животных)

Wi-Fi: 802. 11b/g/n, 2.4 G Hz

Поддерживаемые платформы: Android, iOS

Питание: DC 5V / 1A

Потребляемая мощность: 5 Вт (макс.)

Диапазон рабочих температур: от -10° до 50°C

FCC COMPLIANCE STATEMENT:

This device complies with part 15 of the FCC Rules. Operation is subject to the following two conditions: (1) This device may not cause harmful interference, and (2) this device must accept any interference received, including interference that may cause undesired operation.

Changes or modifications not expressly approved by the party responsible for compliance could void the user's authority to operate the equipment.

The distance between user and products should be no less than 20cm

This equipment has been tested and found to comply with the limits for a Class B digital device, pursuant to part 15 of the FCC Rules. These limits are designed to provide reasonable protection against harmful interference in a residential installation. This equipment generates, uses and can radiate radio frequency energy and, if not installed and used in accordance with the instructions, may cause harmful interference to radio communications. However, there is no guarantee that interference will not occur in a particular installation. If this equipment does cause harmful interference to radio or television reception, which can be determined by turning the equipment off and on, the user is encouraged to try to correct the interference by one or more of the following measures:

- Reorient or relocate the receiving antenna.
- Increase the separation between the equipment and receiver.
- Connect the equipment into an outlet on a circuit different from that to which the receiver is connected.
- Consult the dealer or an experienced radio/TV technician for help.

IC WARNING

This device contains licence-exempt transmitter(s)/receiver(s) that comply with Innovation, Science and Economic Development Canada's licence-exempt RSS(s). Operation is subject to the following two conditions:

- (1) This device may not cause interference.
- (2) This device must accept any interference, including interference that may cause undesired operation of the device

The distance between user and products should be no less than 20cm

ADVERTENCIA IC

Cet appareil contient des émetteurs / récepteurs exemptés de licence conformes aux RSS (RSS) d'Innovation, Sciences et Développement économique Canada. Le fonctionnement est soumis aux deux conditions suivantes :

- (1) Cet appareil ne doit pas causer d'interférences.
- (2) Cet appareil doit accepter toutes les interférences, y compris celles susceptibles de provoquer un fonctionnement indésirable de l'appareil.

La distance entre l'utilisateur et de produits ne devrait pas être inférieure à 20cm

Hereby we: Yi Technology Co.,Ltd., declares that the radio equipment:
YYS.62121 is in compliance with Directive 2014/53/EU.

Product Type: YYS.62121

Wi-Fi: 2.4GHz ,802.11 b/g/n

Max RF power: 17dBm

Manufacture: Yi Technology Co., Ltd

Address: Building 18, NO.55 Chuanhe Road, Pudong New District,
Shanghai, China

The full text of the EU declaration of conformity is available at the following
internet address:

<https://kamistore.eu/pages/product-certification>



FCC ID: 2AF1B-YYS62121
IC: 20436-YYS62121