



# User Guide

## **SUMMARY**

This guide provides information about components, network connection, power management, security, backing up, and more.

## Legal information

© Copyright 2022 HP Development Company, L.P.

Bluetooth is a trademark owned by its proprietor and used by HP Inc. under license. Intel, Celeron, Pentium, and Thunderbolt are trademarks of Intel Corporation or its subsidiaries in the U.S. and/or other countries. Windows is either a registered trademark or trademark of Microsoft Corporation in the United States and/or other countries. The microSD logo and microSD are trademarks of SD-3C LLC. USB Type-C® and USB-C® are registered trademarks of USB Implementers Forum. DisplayPort™ and the DisplayPort™ logo are trademarks owned by the Video Electronics Standards Association (VESA) in the United States and other countries. Miracast® and Wi-Fi are registered trademarks of Wi-Fi Alliance.

The information contained herein is subject to change without notice. The only warranties for HP products and services are set forth in the express warranty statements accompanying such products and services. Nothing herein should be construed as constituting an additional warranty. HP shall not be liable for technical or editorial errors or omissions contained herein.

First Edition: April 2022

Document Part Number: N04484-001

### Product notice

This guide describes features that are common to most products. Some features might not be available on your computer.

Not all features are available in all editions or versions of Windows. Systems may require upgraded and/or separately purchased hardware, drivers, software or BIOS update to take full advantage of Windows functionality. Windows is automatically updated, which is always enabled. High-speed internet and Microsoft account required. ISP fees may apply and additional requirements may apply over time for updates. See <http://www.windows.com>. **If your product ships with Windows in S Mode:** Windows in S Mode works exclusively with apps from the Microsoft Store within Windows. Certain default settings, features, and apps cannot be changed. Some accessories and apps that are compatible with Windows may not work (including some antivirus, PDF writers, driver utilities, and accessibility apps), and performance may vary, even if you switch out of S Mode. If you switch to Windows, you cannot switch back to S Mode. Learn more at [Windows.com/SmodeFAQ](https://windows.com/SmodeFAQ).

To access the latest user guides, go to <http://www.hp.com/support>, and follow the instructions to find your product. Then select **Manuals**.

### Software terms

By installing, copying, downloading, or otherwise using any software product preinstalled on this computer, you agree to be bound by the terms of the HP End User License Agreement (EULA). If you do not accept these license terms, your sole remedy is to return the entire unused product (hardware and software) within 14 days for a full refund subject to the refund policy of your seller.

For any further information or to request a full refund of the price of the computer, please contact your seller.

## Safety warning notice

Reduce the possibility of heat-related injuries or of overheating the computer by following the practices described.

- 
-  **WARNING!** To reduce the possibility of heat-related injuries or of overheating the computer, do not place the computer directly on your lap or obstruct the computer air vents. Use the computer only on a hard, flat surface. Do not allow another hard surface, such as an adjoining optional printer, or a soft surface, such as pillows or rugs or clothing, to block airflow. Also, do not allow the AC adapter to come into contact with the skin or a soft surface, such as pillows or rugs or clothing, during operation. The computer and the AC adapter comply with the user-accessible surface temperature limits defined by applicable safety standards.
-

## Processor configuration setting (select products only)

Important information about processor configurations.

---

 **IMPORTANT:** Select products are configured with an Intel® Pentium® N35xx/N37xx series or a Celeron® N28xx/N29xx/N30xx/N31xx series processor and a Windows® operating system. **If your computer is configured as described, do not change the processor configuration setting in msconfig.exe from 4 or 2 processors to 1 processor.** If you do so, your computer will not restart. You will have to perform a factory reset to restore the original settings.

---



---

# Table of contents

<b>1 Getting started</b>	<b>1</b>
Best practices	1
More HP resources	1
<b>2 Getting to know your computer</b>	<b>3</b>
Locating hardware	3
Locating software	3
Right side	3
Left side	4
Display	5
Low blue light mode (select products only)	5
Wake-on-touch (select products only)	5
Keyboard area	7
Touchpad settings and components	7
Touchpad settings	7
Adjusting touchpad settings	7
Turning on the touchpad	7
Touchpad components	7
Lights	8
Button and fingerprint reader	9
Special keys	11
Action keys	12
HP Hubs Launcher (select products only)	14
Rear	14
Bottom	14
Labels	15
Using a SIM card (select products only)	17
Determining the correct SIM card size for your computer	17
Inserting a nano SIM card	17
<b>3 Connecting to a network</b>	<b>19</b>
Connecting to a wireless network	19
Using the wireless controls	19
Airplane mode key	19
Operating system controls	19
Connecting to a WLAN	19
Using HP Mobile Broadband (select products only)	20
Using eSIM (select products only)	21
Using GPS (select products only)	21
Using Bluetooth wireless devices (select products only)	21

Connecting Bluetooth devices.....	21
Connecting to a wired network—LAN (select products only) .....	22
<b>4 Enjoying entertainment features .....</b>	<b>23</b>
Using the camera.....	23
Using audio .....	23
Connecting speakers .....	23
Connecting headphones.....	23
Connecting headsets .....	24
Using sound settings.....	24
Sound settings.....	24
Audio settings.....	24
Using video .....	24
Connecting a Thunderbolt device using a USB Type-C cable.....	25
Discovering and connecting to Miracast-compatible wireless displays (select products only).....	26
Using data transfer .....	26
Connecting devices to a USB Type-C port (select products only) .....	26
<b>5 Navigating the screen .....</b>	<b>27</b>
Using touchpad and touch screen gestures .....	27
Tap .....	27
Two-finger pinch zoom.....	27
Two-finger slide (touchpad and precision touchpad) .....	28
Two-finger tap (touchpad and precision touchpad) .....	28
Three-finger tap (touchpad and precision touchpad).....	28
Four-finger tap (touchpad and precision touchpad) .....	29
Three-finger swipe (touchpad and precision touchpad).....	29
Four-finger swipe (precision touchpad) .....	29
One-finger slide (touch screen) .....	30
Using an optional keyboard or mouse.....	30
Using an on-screen keyboard (select products only).....	30
<b>6 Managing power.....</b>	<b>31</b>
Using Sleep and Hibernation .....	31
Initiating and exiting Sleep.....	31
Initiating and exiting Hibernation (select products only) .....	32
Shutting down (turning off) the computer .....	32
Using the Power icon .....	33
Running on battery power.....	33
Using HP Fast Charge (select products only).....	33
Displaying battery charge .....	34
Finding battery information in HP Support Assistant (select products only) .....	34
Conserving battery power .....	34
Identifying low battery levels.....	34
Resolving a low battery level .....	35
Resolving a low battery level when external power is available.....	35

Resolving a low battery level when no power source is available.....	35
Resolving a low battery level when the computer cannot exit Hibernation .....	35
Factory-sealed battery .....	35
Running on external power .....	35
<b>7 Maintaining your computer.....</b>	<b>37</b>
Improving performance.....	37
Using Disk Defragmenter .....	37
Using Disk Cleanup .....	37
Using HP 3D DriveGuard (select products only) .....	37
Identifying HP 3D DriveGuard status .....	38
Updating programs and drivers .....	38
Updating both programs and drivers .....	38
Updating programs only.....	38
Updating drivers only .....	38
Cleaning your computer .....	39
Enabling HP Easy Clean (select products only) .....	39
Removing dirt and debris from your computer.....	39
Cleaning your computer with a disinfectant .....	40
Caring for wood veneer (select products only) .....	41
Traveling with or shipping your computer .....	41
<b>8 Securing your computer and information .....</b>	<b>43</b>
Using passwords.....	43
Setting Windows passwords .....	43
Setting Setup Utility (BIOS) passwords.....	44
Using Windows Hello (select products only) .....	45
Using internet security software.....	45
Using antivirus software .....	45
Using firewall software.....	45
Installing software updates .....	46
Using HP TechPulse (select products only) .....	46
Securing your wireless network .....	46
Backing up your software applications and information.....	46
Using an optional security cable (select products only) .....	47
<b>9 Using Setup Utility (BIOS) .....</b>	<b>48</b>
Starting Setup Utility (BIOS) .....	48
Updating Setup Utility (BIOS) .....	48
Determining the BIOS version .....	48
Preparing for a BIOS update .....	49
Downloading a BIOS update .....	49
Installing a BIOS update .....	49
<b>10 Using HP PC Hardware Diagnostics .....</b>	<b>51</b>
Using HP PC Hardware Diagnostics Windows (select products only) .....	51

Using an HP PC Hardware Diagnostics Windows hardware failure ID code .....	51
Accessing HP PC Hardware Diagnostics Windows.....	51
Accessing HP PC Hardware Diagnostics Windows from HP Support Assistant .....	51
Accessing HP PC Hardware Diagnostics Windows from the Start menu (select products only) .....	52
Downloading HP PC Hardware Diagnostics Windows .....	52
Downloading the latest HP PC Hardware Diagnostics Windows version from HP .....	52
Downloading the HP PC Hardware Diagnostics Windows from the Microsoft Store.....	52
Downloading HP Hardware Diagnostics Windows by product name or number (select products only) .....	52
Installing HP PC Hardware Diagnostics Windows .....	53
Using HP PC Hardware Diagnostics UEFI .....	53
Using an HP PC Hardware Diagnostics UEFI hardware failure ID code .....	53
Starting HP PC Hardware Diagnostics UEFI.....	53
Downloading HP PC Hardware Diagnostics UEFI to a USB flash drive .....	54
Downloading the latest HP PC Hardware Diagnostics UEFI version .....	54
Downloading HP PC Hardware Diagnostics UEFI by product name or number (select products only).....	54
Using Remote HP PC Hardware Diagnostics UEFI settings (select products only) .....	55
Downloading Remote HP PC Hardware Diagnostics UEFI.....	55
Downloading the latest Remote HP PC Hardware Diagnostics UEFI version .....	55
Downloading Remote HP PC Hardware Diagnostics UEFI by product name or number .....	55
Customizing Remote HP PC Hardware Diagnostics UEFI settings .....	55
<b>11 Backing up, restoring, and recovering .....</b>	<b>57</b>
Backing up information and creating recovery media .....	57
Using Windows tools for backing up .....	57
Using the HP Cloud Recovery Download Tool to create recovery media (select products only).....	57
Restoring and recovering your system .....	57
Creating a system restore .....	58
Restoring and recovery methods .....	58
Recovering using HP Recovery media .....	58
Changing the computer boot order .....	59
Using HP Sure Recover (select products only) .....	59
<b>12 Electrostatic discharge .....</b>	<b>60</b>
<b>13 Specifications .....</b>	<b>61</b>
Input power.....	61
Operating environment .....	62
<b>14 Accessibility .....</b>	<b>64</b>
HP and accessibility .....	64
Finding the technology tools you need.....	64
The HP commitment.....	64
International Association of Accessibility Professionals (IAAP) .....	65
Finding the best assistive technology.....	65
Assessing your needs .....	65
Accessibility for HP products.....	65
Standards and legislation.....	66
Standards.....	66

Mandate 376 – EN 301 549 .....	66
Web Content Accessibility Guidelines (WCAG).....	66
Legislation and regulations.....	66
Useful accessibility resources and links .....	67
Organizations .....	67
Educational institutions .....	67
Other disability resources .....	67
HP links .....	68
Contacting support .....	68
<b>Index .....</b>	<b>69</b>

---

# 1 Getting started

This computer is a powerful tool designed to enhance your work and entertainment.

Read this chapter to learn about best practices after you set up your computer, fun things to do with your computer, and where to find additional HP resources.

## Best practices

After you set up and register the computer, we recommend the following steps to get the most out of your smart investment:

- Back up your hard drive by creating recovery media. See [Backing up, restoring, and recovering on page 57](#).
- If you haven't already done so, connect to a wired or wireless network. See details in [Connecting to a network on page 19](#).
- Become familiar with the computer hardware and software. For more information, see [Getting to know your computer on page 3](#) and [Enjoying entertainment features on page 23](#).
- Update or purchase antivirus software. See [Using antivirus software on page 45](#).
- **Access HP Support Assistant app**—For quick online support, open the HP Support Assistant app (select products only). HP Support Assistant optimizes computer performance and resolves problems using the latest software updates, diagnostic tools, and guided assistance. Select the **Search** icon in the taskbar, type `support` in the search box, and then select **HP Support Assistant**.

## More HP resources

To locate resources that provide product details, how-to information, and more, use this table.

**Table 1-1 Additional information**

Resource	Contents
<i>Setup Instructions</i>	<ul style="list-style-type: none"><li>• Overview of computer setup and features</li></ul>
HP support	<ul style="list-style-type: none"><li>• Online chat with an HP technician</li></ul>
For HP support, go to <a href="http://www.hp.com/support">http://www.hp.com/support</a> , and follow the instructions to find your product.	<ul style="list-style-type: none"><li>• Support telephone numbers</li><li>• Replacement parts videos (select products only)</li></ul>
– or –	<ul style="list-style-type: none"><li>• Maintenance and service guides</li></ul>
Select the <b>Search</b> icon in the taskbar, type <code>support</code> in the search box, and then select <b>HP Support Assistant</b> .	<ul style="list-style-type: none"><li>• HP service center locations</li></ul>
– or –	
Select the question mark icon in the taskbar.	

**Table 1-1 Additional information (continued)**

Resource	Contents
<p><i>Safety &amp; Comfort Guide</i></p> <p>To access this guide:</p> <ul style="list-style-type: none"><li>■ Select the <b>Search</b> icon in the taskbar, type <code>HP Documentation</code> in the search box, and then select <b>HP Documentation</b>.</li></ul> <p>– or –</p> <ul style="list-style-type: none"><li>■ Go to <a href="http://www.hp.com/ergo">http://www.hp.com/ergo</a>.</li></ul> <p><b>IMPORTANT:</b> You must be connected to the internet to access the latest version of the user guide.</p>	<ul style="list-style-type: none"><li>• Proper workstation setup</li><li>• Guidelines for posture and work habits that increase your comfort and decrease your risk of injury</li><li>• Electrical and mechanical safety information</li></ul>
<p><i>Regulatory, Safety, and Environmental Notices</i></p> <p>To access this document:</p> <ul style="list-style-type: none"><li>■ Select the <b>Search</b> icon in the taskbar, type <code>support</code> in the search box, and then select <b>HP Documentation</b>.</li></ul>	<ul style="list-style-type: none"><li>• Important regulatory notices, including information about proper battery disposal, if needed.</li></ul>
<p><i>Limited Warranty*</i></p> <p>To access this document:</p> <ul style="list-style-type: none"><li>■ Select the <b>Search</b> icon in the taskbar, type <code>support</code> in the search box, and then select <b>HP Documentation</b>.</li></ul> <p>– or –</p> <ul style="list-style-type: none"><li>■ Go to <a href="http://www.hp.com/go/orderdocuments">http://www.hp.com/go/orderdocuments</a>.</li></ul> <p><b>IMPORTANT:</b> You must be connected to the internet to access the latest version of the user guide.</p>	<ul style="list-style-type: none"><li>• Specific warranty information about this computer</li></ul>

\*You can find your HP Limited Warranty located with the user guides on your product and/or on the CD or DVD provided in the box. In some countries or regions, HP might provide a printed warranty in the box. For countries or regions where the warranty is not provided in printed format, you can request a copy from <http://www.hp.com/go/orderdocuments>. For products purchased in Asia Pacific, you can write to HP at POD, PO Box 161, Kitchener Road Post Office, Singapore 912006. Include your product name, and your name, phone number, and postal address.

## 2 Getting to know your computer

Your computer features top-rated components. This chapter provides details about your components, where they are located, and how they work.

### Locating hardware

To find out what hardware is installed on your computer, select the **Search** icon in the taskbar, type `device manager` in the search box, and then select the **Device Manager** app.

For information about system hardware components and the system BIOS version number, press `fn+esc` (select products only).

### Locating software

To find out what software is installed on your computer, right-click the **Start** button, and then select **Apps and Features**.

### Right side

Identify the components on the right side of the computer.

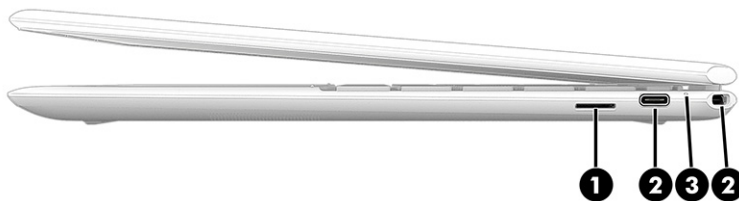

**Table 2-1** Right-side components and their descriptions

Component	Description
(1) microSD™ memory card reader	<p>Reads optional memory cards that enable you to store, manage, share, or access information.</p> <p>To insert a card:</p> <ol style="list-style-type: none"><li>1. Hold the card label-side up, with connectors facing the computer.</li><li>2. Insert the card into the memory card reader, and then press in on the card until it is firmly seated.</li></ol> <p>To remove a card:</p> <ul style="list-style-type: none"><li>■ Press in on the card, and then remove it from the memory card reader.</li></ul>

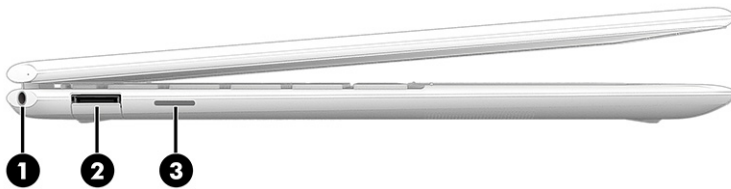

**Table 2-1 Right-side components and their descriptions (continued)**

Component	Description
(2) USB Type-C® power connector and Thunderbolt™ ports with HP Sleep and Charge and DisplayPort™ output (2)	<p>Connect an AC adapter that has a USB Type-C connector, supplying power to the computer and, if needed, charging the computer battery.</p> <p>– and –</p> <p>Connect USB devices, provide high-speed data transfer, and charge small devices (such as a smartphone), even when the computer is off.</p> <p><b>NOTE:</b> Use a standard USB Type-C charging cable or cable adapter (purchased separately) when charging a small external device.</p> <p>– and –</p> <p>Connect a display device that has a USB Type-C connector, providing DisplayPort output.</p> <p><b>NOTE:</b> Your computer might also support a Thunderbolt docking station.</p>
(3) AC adapter and battery light	<ul style="list-style-type: none"><li>• White: The AC adapter is connected and the battery is fully charged.</li><li>• Blinking amber: The AC adapter is disconnected and the battery has reached a low battery level.</li><li>• Amber: The AC adapter is connected and the battery is charging.</li><li>• Off: The battery is not charging.</li></ul>

## Left side

Identify the components on the left side of the computer.



**Table 2-2 Left-side components and their descriptions**

Component	Description
(1) Audio-out (headphone)/Audio-in (microphone) combo jack	<p>Connects optional powered stereo speakers, headphones, earbuds, a headset, or a television audio cable. Also connects an optional headset microphone. This jack does not support optional standalone microphones.</p> <p><b>WARNING!</b> To reduce the risk of personal injury, adjust the volume before putting on headphones, earbuds, or a headset. For additional safety information, see the <i>Regulatory, Safety, and Environmental Notices</i>.</p> <p>To access this guide:</p> <ul style="list-style-type: none"><li>■ Select the <b>Search</b> icon in the taskbar, type <code>HP Documentation</code> in the search box, and then select <b>HP Documentation</b>.</li></ul> <p><b>NOTE:</b> When a device is connected to the jack, the computer speakers are disabled.</p>
(2) USB SuperSpeed 10 Gbps port with HP Sleep and Charge	<p>Connects a USB device, provides high-speed data transfer, and charges small devices (such as a smartphone), even when the computer is off.</p> <p><b>NOTE:</b> Use a standard USB Type-A charging cable or cable adapter (purchased separately) when charging a small external device.</p>
(3) Nano SIM card slot (select products only)	<p>Supports a wireless subscriber identity module (SIM) card.</p> <p>For SIM card installation steps, see <a href="#">Using a SIM card (select products only) on page 17</a>.</p>

## Display

The computer display can include essential components such as speakers, antennas, cameras, and microphones.

### Low blue light mode (select products only)

Your computer display is shipped from the factory in low blue light mode for improved eye comfort and safety. Also, blue light mode automatically adjusts blue light emissions when you are using the computer at night or for reading.

**WARNING!** To reduce the risk of serious injury, read the *Safety & Comfort Guide*. It describes proper workstation setup and proper posture, health, and work habits for computer users. The *Safety & Comfort Guide* also provides important electrical and mechanical safety information. The *Safety & Comfort Guide* is available on the web at <http://www.hp.com/ergo>.

### Wake-on-touch (select products only)

Use the wake-on-touch feature to bring the computer out of the Sleep state quickly.

To wake your computer, double-tap the touchscreen.

**NOTE:** This feature is available in stand, tent, and tablet modes, but not in clamshell mode.

**NOTE:** This feature is not available when the computer is in Hibernation.

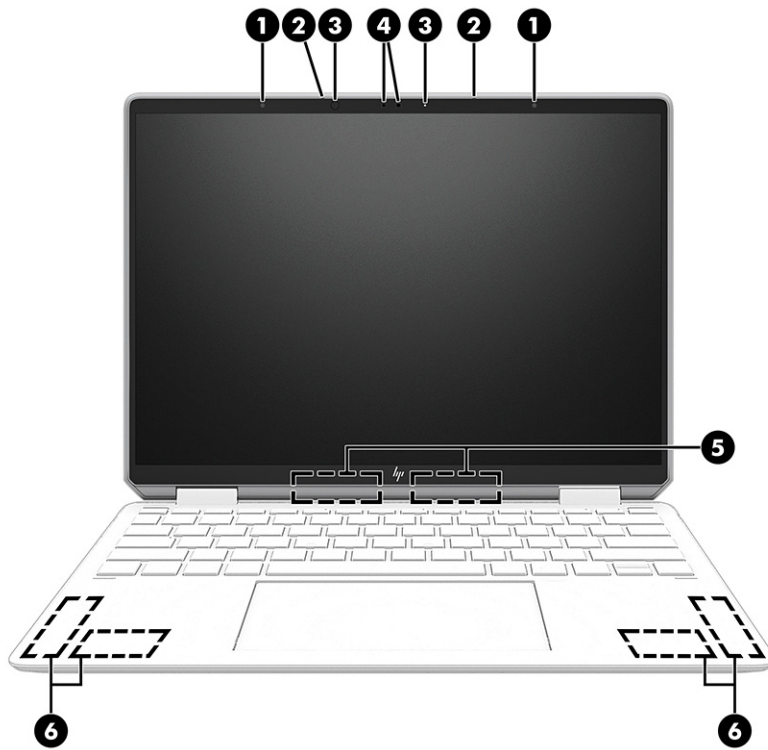

**Table 2-3** Display components and their descriptions

Component	Description
(1) Ambient light and color sensor (select products only)	Adjust the brightness of the display, depending on the ambient light, and manages and controls the color temperature. Color temperature enables you to measure and adjust the warmth or coolness of the light source.  <b>NOTE:</b> Do not cover the sensor. The display brightness adjusts if the sensor notices light change.
(2) Internal microphones (2)	Record sound.
(3) Camera light(s)	On: One or more cameras are in use.
(4) Camera(s)	Allow(s) you to video chat, record video, and record still images. To use your camera, see <a href="#">Using the camera on page 23</a> . Some cameras also allow a facial recognition logon to Windows, instead of a password logon. For more information, see <a href="#">Using Windows Hello (select products only) on page 45</a> .  <b>NOTE:</b> Camera functions vary depending on the camera hardware and software installed on your product.
(5) WLAN antennas*	Send and receive wireless signals to communicate with wireless local area networks (WLANs).
(6) WWAN antennas* (select products only)	Send and receive wireless signals to communicate with wireless wide area networks (WWANs).

**Table 2-3 Display components and their descriptions (continued)**

Component	Description
	<p>*The antennas are not visible from the outside of the computer. For optimal transmission, keep the areas immediately around the antennas free from obstructions.</p> <p>For wireless regulatory notices, see the section of the <i>Regulatory, Safety, and Environmental Notices</i> that applies to your country or region.</p> <p>To access this guide:</p> <ul style="list-style-type: none"><li>■ Select the <b>Search</b> icon in the taskbar, type <code>HP Documentation</code> in the search box, and then select <b>HP Documentation</b>.</li></ul>

## Keyboard area

Keyboards can vary by language.



**NOTE:** The keyboard area, including the function keys and (select products only) power button, is disabled in stand, tent, and tablet modes. To enable the keyboard, including the power button, change to the clamshell mode.

## Touchpad settings and components

Learn the touchpad settings and components.

### Touchpad settings

Learn how to adjust touchpad settings.

#### Adjusting touchpad settings

Use these steps to adjust touchpad settings and gestures.

1. Select the **Search** icon in the taskbar, type `touchpad settings` in the search box, and then press **enter**.
2. Choose a setting.

#### Turning on the touchpad

Follow these steps to turn on the touchpad.

1. Select the **Search** icon in the taskbar, type `touchpad settings` in the search box, and then press **enter**.
2. Using an external mouse, click the **touchpad** button.

If you are not using an external mouse, press the **Tab** key repeatedly until the pointer rests on the **touchpad** button. Then press the **spacebar** to select the button.

### Touchpad components

Identify the touchpad components.

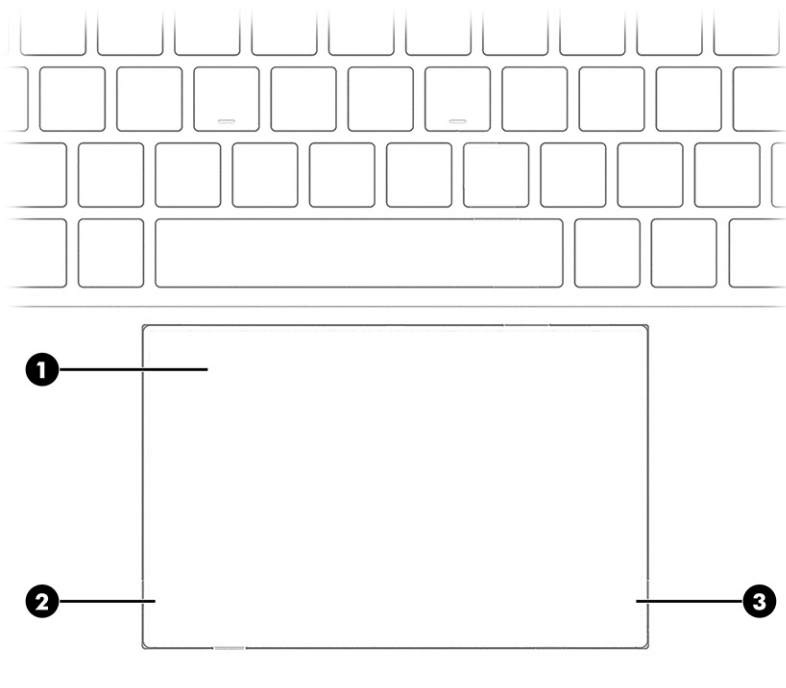
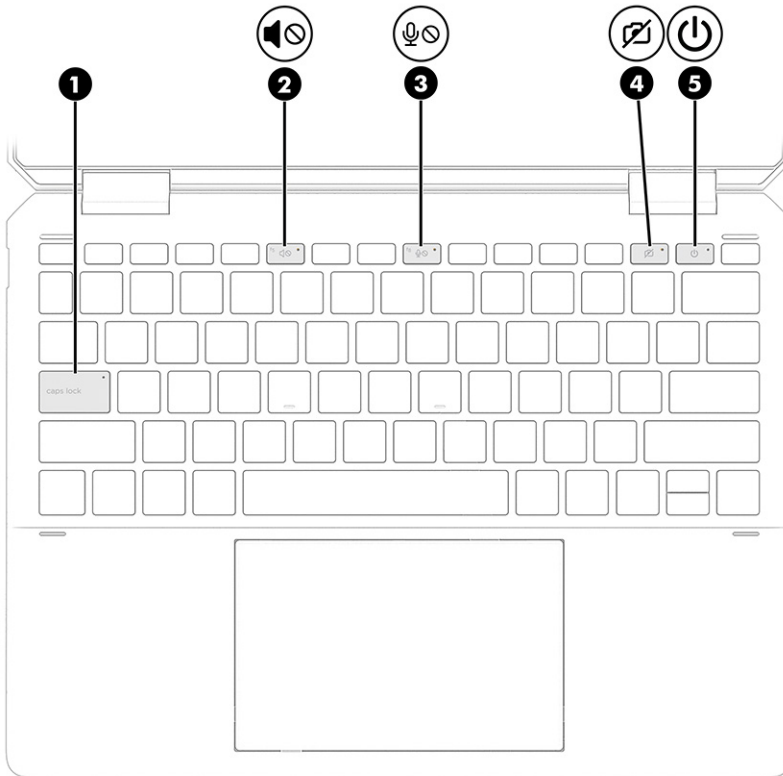

**Table 2-4 Touchpad components and their descriptions**





Component	Description
(1) Touchpad zone	Reads your finger gestures to move the pointer or activate items on the screen.  <b>NOTE:</b> For more information, see <a href="#">Using touchpad and touch screen gestures on page 27</a> .
(2) Left touchpad button	Functions like the left button on an external mouse.
(3) Right touchpad button	Functions like the right button on an external mouse.

## Lights

Identify the lights on the computer.

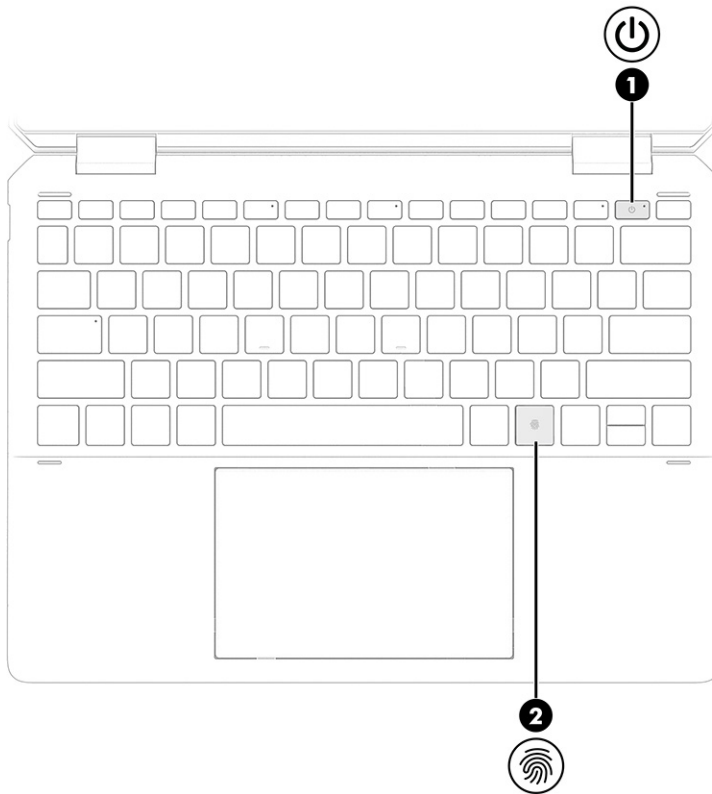

**Table 2-5** Lights and their descriptions



Component	Description
(1) Caps lock light	On: Caps lock is on, which switches the key input to all capital letters.
(2)  Mute light	<ul style="list-style-type: none"> <li>On: Computer sound is off.</li> <li>Off: Computer sound is on.</li> </ul>
(3)  Microphone mute light	<ul style="list-style-type: none"> <li>On: Microphone is off.</li> <li>Off: Microphone is on.</li> </ul>
(4)  Camera privacy light	<ul style="list-style-type: none"> <li>On. The camera is off.</li> <li>Off. The camera is on.</li> </ul>
(5)  Power light	<ul style="list-style-type: none"> <li>On: The computer is on.</li> <li>Blinking (select products only): The computer is in the Sleep state, a power-saving state. The computer shuts off power to the display and other unnecessary components.</li> <li>Off: Depending on your computer model, the computer is off, in Hibernation, or in Sleep. Hibernation is the power-saving state that uses the least amount of power.</li> </ul>

## Button and fingerprint reader

Identify the computer button and fingerprint reader.



**Table 2-6** Button and fingerprint reader and their descriptions

Component	Description
(1)  Power button	<ul style="list-style-type: none"> <li>• When the computer is off, press the button briefly to turn on the computer.</li> <li>• When the computer is on, press the button briefly to initiate Sleep.</li> <li>• When the computer is in the Sleep state, press the button briefly to exit Sleep (select products only).</li> <li>• When the computer is in Hibernation, press the button briefly to exit Hibernation.</li> </ul> <p><b>IMPORTANT:</b> Pressing and holding down the power button results in the loss of unsaved information.</p> <p>If the computer has stopped responding and shutdown procedures are ineffective, press and hold the power button down for at least 10 seconds to turn off the computer.</p> <p>To learn more about your power and sleep settings:</p> <ul style="list-style-type: none"> <li>■ Right-click the <b>Power</b> icon , and then select <b>Power and sleep settings</b>.</li> </ul>

**Table 2-6 Button and fingerprint reader and their descriptions (continued)**

Component	Description
(2)  Fingerprint reader	<p>Allows a fingerprint logon to Windows, instead of a password logon.</p> <ul style="list-style-type: none"> <li>Touch your finger to the fingerprint reader. See <a href="#">Using Windows Hello (select products only) on page 45</a> for details.</li> </ul> <p><b>IMPORTANT:</b> To prevent fingerprint logon issues, make sure when you register your fingerprint that all sides of your finger are registered by the fingerprint reader.</p>

## Special keys

Identify the special keys.

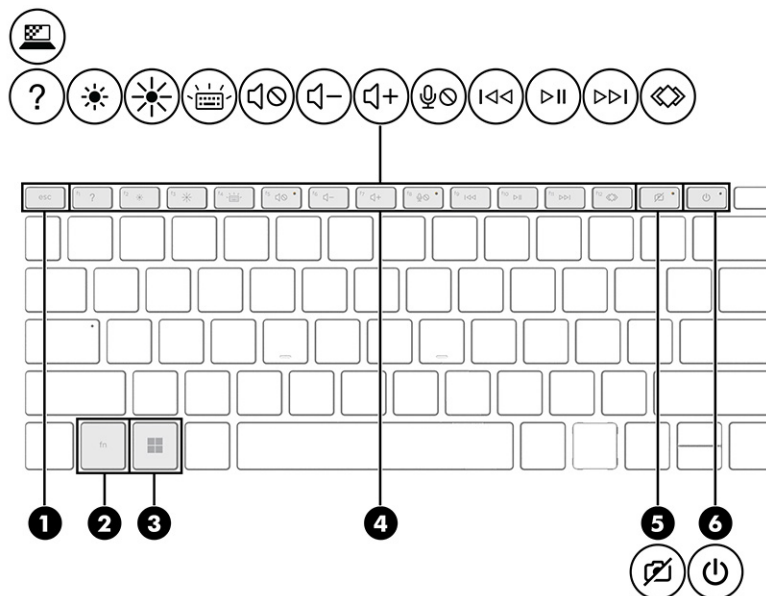



**Table 2-7 Special keys and their descriptions**

Component	Description
(1) <code>esc</code> key	Displays system information when pressed in combination with the <code>fn</code> key.
(2) <code>fn</code> key	Executes specific functions when pressed in combination with another key.
(3)  Windows key	<p>Opens the Start menu.</p> <p><b>NOTE:</b> Pressing the Windows key again will close the Start menu.</p>
(4) Action keys	Execute frequently used system functions as defined by the icon symbols on <code>f1</code> through <code>f12</code> function keys. See <a href="#">Action keys on page 12</a> .



**Table 2-7 Special keys and their descriptions (continued)**

Component	Description
(5)  Camera privacy key	Turns the camera off and on.  <b>NOTE:</b> For more information, see <a href="#">Using the camera on page 23</a> .
(6)  Power button	<ul style="list-style-type: none"><li>• When the computer is off, press the button briefly to turn on the computer.</li><li>• When the computer is on, press the button briefly to initiate Sleep.</li><li>• When the computer is in the Sleep state, press the button briefly to exit Sleep (select products only).</li><li>• When the computer is in Hibernation, press the button briefly to exit Hibernation.</li></ul> <p><b>IMPORTANT:</b> Pressing and holding down the power button results in the loss of unsaved information.</p> <p>If the computer has stopped responding and shutdown procedures are ineffective, press and hold the power button down for at least 10 seconds to turn off the computer.</p> <p>To learn more about your power and sleep settings:</p> <ul style="list-style-type: none"><li>■ Right-click the <b>Power</b> icon , and then select <b>Power and sleep settings</b>.</li></ul>

## Action keys

Identify the action keys.

The action keys execute frequently used system functions as defined by the icon symbols on **f1** through **f12**. The action keys vary by computer.











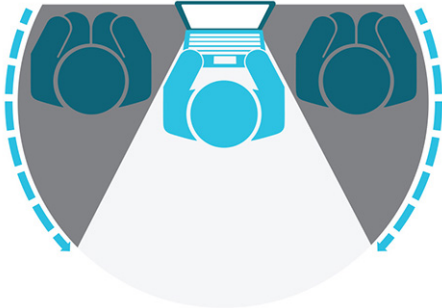

- To use an action key, press and hold the key.

 **NOTE:** On some products, you must press the **fn** key in combination with the action key.

**Table 2-8 Action keys and their descriptions**

Icon	Description
	On select products only, opens the "How to get help in Windows" webpage.

**Table 2-8 Action keys and their descriptions (continued)**

Icon	Description
	<p>On select products only, helps prevent side-angle viewing from onlookers. If needed, decrease or increase brightness for well-lit or darker environments. Press the key again to turn off the privacy screen.</p>
	
	<p>Decreases the screen brightness incrementally as long as you hold down the key.</p>
	<p>Increases the screen brightness incrementally as long as you hold down the key.</p>
	<p>Turns the keyboard backlight off or on. On select products, you can adjust the brightness of the keyboard backlight. Press the key repeatedly to adjust the brightness from high (when you first start up the computer), to low, to off. After you adjust the keyboard backlight setting, the backlight will revert to your previous setting each time you turn on the computer. The keyboard backlight will turn off after 30 seconds of inactivity. To turn the keyboard backlight back on, press any key or tap the touchpad (select products only). To conserve battery power, turn off this feature.</p>
	<p>Mutes or restores speaker sound.</p>
	<p>Decreases speaker volume incrementally while you hold down the key.</p>
	<p>Increases speaker volume incrementally while you hold down the key.</p>
	<p>Mutes the microphone.</p>
	<p>Plays the previous track of an audio CD or the previous section of a DVD or a Blu-ray Disc (BD).</p>
	<p>Starts, pauses, or resumes playback of an audio CD, a DVD, or a BD.</p>
	<p>Plays the next track of an audio CD or the next section of a DVD or a BD.</p>
	<p>Opens HP Hubs Launcher, where you can open HP apps such as HP Command Center, OMEN Gaming Hub, myHP, and HP Palette, depending on your computer model. For more information, see <a href="#">HP Hubs Launcher (select products only) on page 14</a>.</p>

## HP Hubs Launcher (select products only)

Press or hold **f12** to open the HP Hubs Launcher. From the HP Hubs Launcher, you can open HP apps such as HP Command Center, OMEN Gaming Hub, myHP, and HP Palette.

- Press **f12** briefly to open the HP Hubs Launcher. Then use the mouse pointer to select an app to open.

-or-

Hold **f12** to change the selected apps and then automatically open them.

Depending on your model, the following apps can be included in the HP Hubs Launcher:

- HP Command Center
  - Select **System Control** to adjust the temperature or cooling preference on your computer.
  - Select **GlamCam** to adjust camera-related settings for video calls.
- OMEN Gaming Hub, where you can customize your computer for your specific gaming needs.
- myHP, where you can learn more about your PC and the utilities that HP offers.
- HP Palette, which allows you to access creative tools in one place, simplifies the creative process, and helps find the right photos and assets in less time.

## Rear

Identify the rear component.



**Table 2-9** Rear component and its description

Component	Description
Vent	Enables airflow to cool internal components.  <b>NOTE:</b> The computer fan starts up automatically to cool internal components and prevent overheating. It is normal for the internal fan to cycle on and off during routine operation.

## Bottom

Identify the bottom components.



**NOTE:** Your computer might look slightly different from the following illustration.

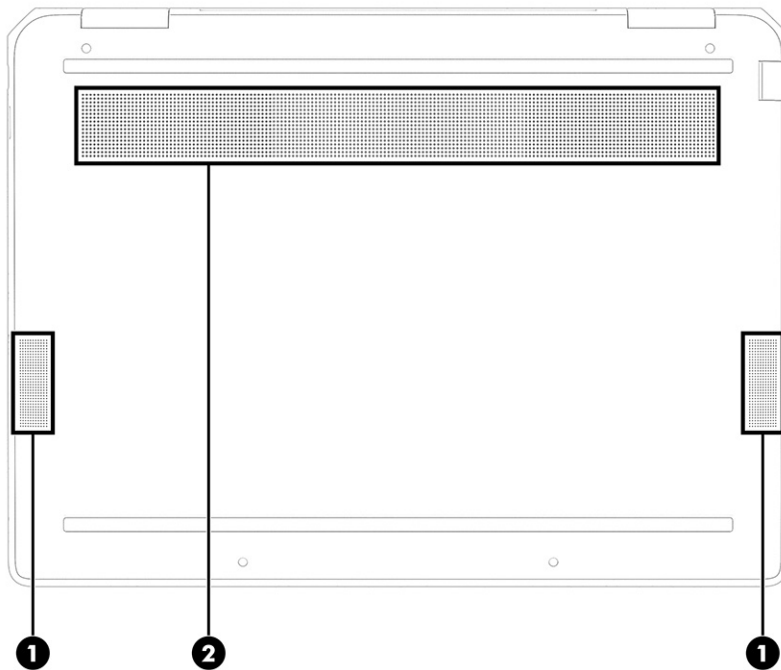

**Table 2-10** Bottom components and their descriptions

Component		Description
(1)	Speakers	Produce sound.
(2)	Vent	Enables airflow to cool internal components.

**NOTE:** The computer fan starts up automatically to cool internal components and prevent overheating. It is normal for the internal fan to cycle on and off during routine operation.

## Labels

The labels affixed to the computer provide information that you might need when you troubleshoot system problems or travel internationally with the computer. Labels can be in paper form or imprinted on the product.

**IMPORTANT:** Check the following locations for the labels described in this section: the bottom of the computer, inside the battery bay, under the service door, on the back of the display, or on the bottom of a tablet kickstand.

- Service label—Provides important information to identify your computer. When contacting support, you might be asked for the serial number, the product number, or the model number. Locate this information before you contact support.

Your service label will resemble one of the following examples. Refer to the illustration that most closely matches the service label on your computer.



**Table 2-11 Service label components**

Component
(1) Serial number
(2) Product ID
(3) HP product name and model number

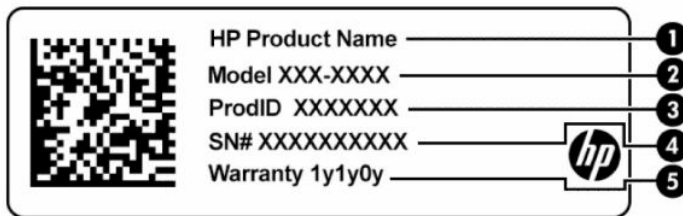

**Table 2-12 Service label components**

Component
(1) HP product name
(2) Model number
(3) Product ID
(4) Serial number
(5) Warranty period

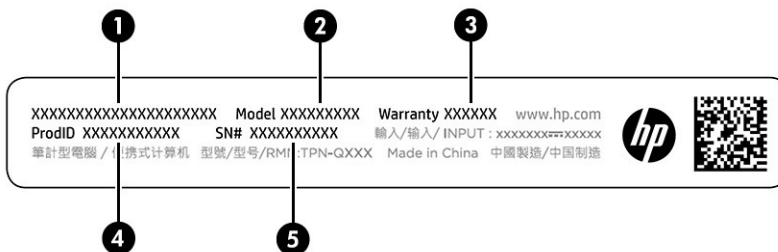

**Table 2-13 Service label components**

Component
(1) HP product name

**Table 2-13 Service label components (continued)**

Component	
(2)	Model number
(3)	Warranty period
(4)	Product ID
(5)	Serial number

- Regulatory labels—Provide regulatory information about the computer.
- Wireless certification labels—Provide information about optional wireless devices and the approval markings for the countries or regions in which the devices have been approved for use.

## Using a SIM card (select products only)

Use these instructions to insert a SIM card.

 **IMPORTANT:** You can damage the SIM card if you insert the wrong size card or insert it or the SIM card tray in the wrong direction. The card might also become stuck in the slot. Do not use SIM card adapters. To prevent damage to the SIM card or connectors, use minimal force when inserting or removing a SIM card.

### Determining the correct SIM card size for your computer

Before purchasing a SIM card, follow these instructions to determine the correct SIM card size for your computer.

1. Go to <http://www.hp.com/support>, and then search for your computer by product name or number.
2. Select **Product Information**.
3. Refer to the listed options to determine which card to purchase.

### Inserting a nano SIM card

To insert a nano SIM card, follow these steps.

1. Turn off the computer by using the **Shut down** command.
2. Position the computer display-side up on a flat surface.
3. Press in gently on the SIM card access tray to disengage the SIM lock, and the tray will pop out of the slot (1).
4. Remove the tray (2) from the computer and insert the card (3).

5. Replace the tray in the computer. Press in gently on the tray **(4)** until it is firmly seated.

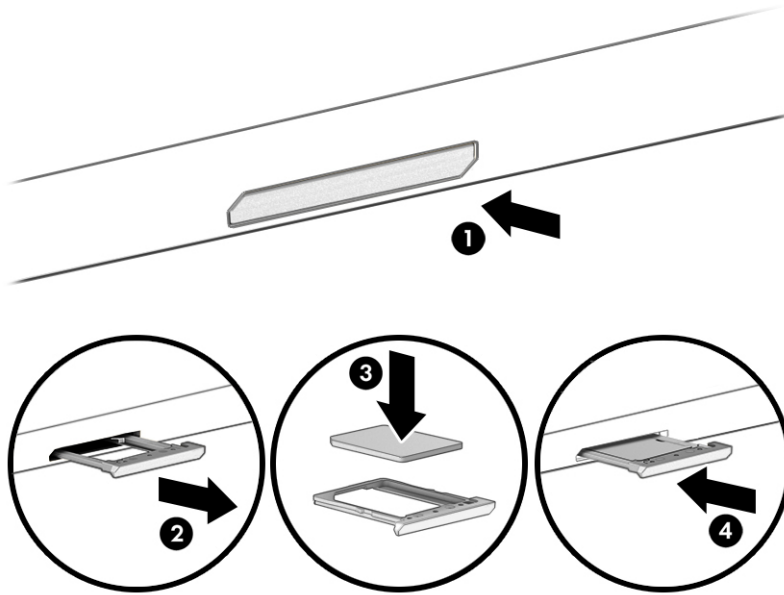

To remove the SIM card, press in gently on the SIM card access tray to disengage the SIM lock, and the tray will pop out of the slot. Remove the SIM card. Replace the tray in the computer and press in gently on the tray until it is firmly seated.

---

## 3 Connecting to a network

Your computer can travel with you wherever you go. But even at home, you can explore the globe and access information from millions of websites by using your computer and a wired or wireless network connection. This chapter helps you get connected to that world.

### Connecting to a wireless network

Your computer might be equipped with one or more wireless devices.

- **WLAN device**—Connects the computer to wireless local area networks (commonly referred to as Wi-Fi networks, wireless LANs, or WLANs) in corporate offices, your home, and public places such as airports, restaurants, coffee shops, hotels, and universities. The WLAN device in your computer communicates with a wireless router or a wireless access point.
- **HP Mobile Broadband Module**—Gives you wireless connectivity over a wireless wide area network (WWAN), a much larger area. Mobile network operators install base stations (similar to cell phone towers) throughout large geographic areas, effectively providing coverage across entire states, regions, or even countries.
- **Bluetooth® device**—Creates a personal area network (PAN) to connect to other Bluetooth-enabled devices such as computers, phones, printers, headsets, speakers, and cameras. In a PAN, each device communicates directly with other devices, and devices must be relatively close together—typically within 10 m (approximately 33 ft) of each other.

### Using the wireless controls

You can control the wireless devices in your computer using one or more features.

- **Airplane mode key** (also called *wireless button* or *wireless key*)
- **Operating system controls**

#### Airplane mode key

The computer might have an airplane mode key, one or more wireless devices, and one or two wireless lights. All the wireless devices on your computer are enabled at the factory.

The wireless light indicates the overall power state of your wireless devices, not the status of individual devices.

#### Operating system controls

The Network and Sharing Center allows you to set up a connection or network, connect to a network, and diagnose and repair network problems.

To use operating system controls:

On the taskbar, right-click the network status icon, and then select **Network and Internet settings**.

### Connecting to a WLAN

Before you can connect to a WLAN with this procedure, you must first set up internet access.





---

**NOTE:** When you are setting up internet access in your home, you must establish an account with an internet service provider (ISP). To purchase internet service and a modem, contact a local ISP. The ISP will help set up the modem, install a network cable to connect your wireless router to the modem, and test the internet service.

---

1. Be sure that the WLAN device is on.
2. On the taskbar, select the network status icon, and then connect to one of the available networks.

If the WLAN is a security-enabled WLAN, you are prompted to enter a security code. Enter the code, and then select **Next** to complete the connection.



---

**NOTE:** If no WLANs are listed, you might be out of range of a wireless router or access point.



**NOTE:** If you do not see the WLAN that you want to connect to:

1. On the taskbar, right-click the network status icon, and then select **Network and Internet settings**.
  2. Select **Wi-Fi**, and then select **Manage known networks**.
  3. Select **Add network**.
- 

3. Follow the on-screen instructions to complete the connection.

After the connection is made, right-click the network status icon at the far right of the taskbar to verify the name and status of the connection.



---

**NOTE:** The functional range (how far your wireless signals travel) depends on WLAN implementation, router manufacturer, and interference from other electronic devices or structural barriers such as walls and floors.

---

## Using HP Mobile Broadband (select products only)

Your HP Mobile Broadband computer has built-in support for mobile broadband service. Your new computer, when used with a mobile operator's network, gives you the freedom to connect to the internet, send email, or connect to your corporate network without the need for Wi-Fi hotspots.

You might need the HP Mobile Broadband Module IMEI number, MEID number, or both to activate mobile broadband service. The number might be printed on a label located on the bottom of your computer, inside the battery bay, under the service door, or on the back of the display.

1. On the taskbar, right-click the network status icon.
2. Select **Network and Internet settings**.
3. Under the **Network & Internet** section, select **Cellular**, and then select from the available options.

Some mobile network operators require the use of a subscriber identity module (SIM) card. A SIM card contains basic information about you, such as a personal identification number (PIN), as well as network information. Some computers include a SIM card that is preinstalled. If the SIM card is not preinstalled, it might be included with the HP Mobile Broadband documents provided with your computer, or the mobile network operator might provide it separately from the computer.

For information about HP Mobile Broadband and how to activate service with a preferred mobile network operator, see the HP Mobile Broadband information included with your computer.

## Using eSIM (select products only)

Your computer might be equipped with an eSIM. An eSIM is a programmable version of the commonly used SIM that you can use to download different profiles from selected carriers.

An eSIM lets you connect to the internet over a cellular data connection. With an eSIM, you do not need to get a SIM card from your mobile operator, and you can quickly switch between mobile operators and data plans. For example, you might have one cellular data plan for work and a different plan with another mobile operator for personal use. If you travel, you can connect in more places by finding mobile operators with plans in that area.

You can implement eSIMs in two ways:

- The eSIM chip can be embedded (eUICC). The notebook then operates as a dual SIM, one as eUICC and the second as standard micro or nano SIM card on a SIM card tray. Only one SIM can be active at a time.
- A removable physical eSIM is placed on a SIM card tray like a standard micro or nano SIM card, but the eSIM is not limited to a single carrier (physical blank eSIM).

You must add an eSIM profile to connect to the internet using cellular data. To add a profile, manage SIM profiles, and learn how to use an eSIM, go to <https://www.support.microsoft.com>, and type `Use an eSIM` in the search bar.

## Using GPS (select products only)

Your computer might be equipped with a Global Positioning System (GPS) device. GPS satellites deliver location, speed, and direction information to GPS-equipped systems.

To enable GPS, be sure location is enabled under the Location setting.

- Select the **Search** icon in the taskbar, type `location` in the search box, select **Location privacy settings**, and then select a setting.

## Using Bluetooth wireless devices (select products only)

A Bluetooth device provides short-range wireless communications that replace the physical cable connections that traditionally link electronic devices.

- Computers (desktop, notebook)
- Phones (cellular, cordless, smartphone)
- Imaging devices (printer, camera)
- Audio devices (headset, speakers)
- Mouse
- External keyboard

## Connecting Bluetooth devices

Before you can use a Bluetooth device, you must establish a Bluetooth connection.

1. Select the **Search** icon in the taskbar, type `bluetooth` in the search box, and then select **Bluetooth and other devices settings**.
2. Enable **Bluetooth**, if it is not already enabled.

3. Select **Add device**, and then in the **Add a device** dialog box, select **Bluetooth**.
4. Select your device from the list, and then follow the on-screen instructions.

 **NOTE:** If the device requires verification, a pairing code is displayed. On the device that you are adding, follow the on-screen instructions to verify that the code on your device matches the pairing code. For more information, see the documentation provided with the device.

 **NOTE:** If your device does not appear in the list, be sure that Bluetooth on that device is turned on. Some devices might have additional requirements; see the documentation provided with the device.

## Connecting to a wired network—LAN (select products only)

Use a LAN connection if you want to connect the computer directly to a router in your home (instead of working wirelessly) or if you want to connect to an existing network at your office.

If there is no RJ-45 (network) port on the computer, connecting to a LAN requires a network cable and a network jack or an optional docking device or expansion product.

To connect the network cable, follow these steps:

1. Plug the network cable into the network jack **(1)** on the computer.
2. Plug the other end of the network cable into a network wall jack **(2)** or router.

 **NOTE:** If the network cable contains noise suppression circuitry **(3)**, which prevents interference from TV and radio reception, orient the circuitry end of the cable toward the computer.

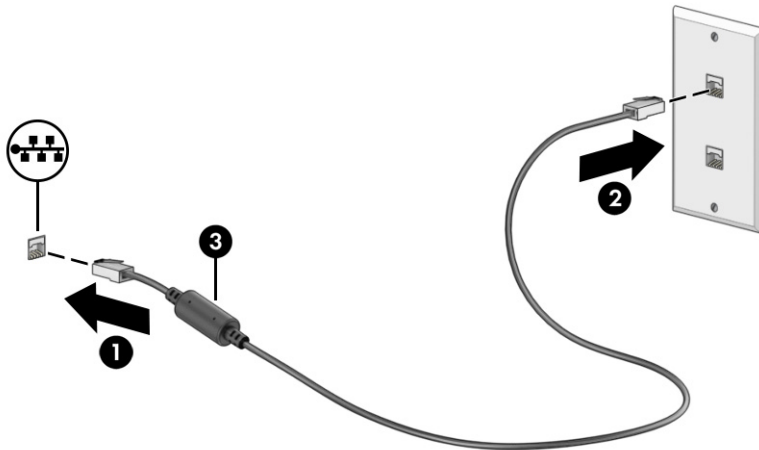

---

## 4 Enjoying entertainment features

Use your HP computer as an entertainment hub to socialize via the camera, enjoy and manage your music, and download and watch movies. Or, to make your computer an even more powerful entertainment center, connect external devices like a monitor, projector, TV, speakers, or headphones.

### Using the camera

Your computer has one or more cameras that enable you to connect with others for work or play. Cameras can be front facing, rear facing, or pop up.

To determine which camera or cameras are on your product, see [Getting to know your computer on page 3](#).

Most cameras allow you to video chat, record video, and record still images. Some also provide HD (high-definition) capability, apps for gaming, or facial recognition software like Windows Hello. See [Securing your computer and information on page 43](#) for details about using Windows Hello.

On select products, you can also enhance your camera privacy by turning the camera off. By default, the camera is turned on. To turn off your camera, press the camera privacy key. The camera privacy light turns on. To turn the camera back on, press the key again.

To use your camera, select the **Search** icon in the taskbar, type `camera` in the search box, and then select **Camera** from the list of applications.

---

 **NOTE:** The first time you select the Camera app, you must select whether Camera can access your precise location.

---

### Using audio

You can download and listen to music, stream audio content (including radio) from the web, record audio, or mix audio and video to create multimedia. You can also play music CDs on the computer (on select products) or attach an external optical drive to play CDs. To enhance your listening enjoyment, attach external audio devices such as speakers or headphones.

### Connecting speakers

You can attach wired speakers to your computer by connecting them to a USB port or to the audio-out (headphone)/audio-in (microphone) combo jack on your computer or on a docking station.

To connect wireless speakers to your computer, follow the device manufacturer's instructions. Before connecting speakers, lower the volume setting.

### Connecting headphones

You can connect wired headphones to the audio-out (headphone)/audio-in (microphone) combo jack on your computer.

---

 **WARNING!** To reduce the risk of personal injury, lower the volume setting before putting on headphones, earbuds, or a headset. For additional safety information, see the *Regulatory, Safety, and Environmental Notices*.

---

To access this document:

- Select the **Search** icon in the taskbar, type `HP Documentation` in the search box, and then select **HP Documentation**.
- 

To connect wireless headphones to your computer, follow the device manufacturer's instructions.

## Connecting headsets

Headphones combined with a microphone are called *headsets*. You can connect wired headsets to the audio-out (headphone)/audio-in (microphone) combo jack on your computer.

-  **WARNING!** To reduce the risk of personal injury, lower the volume setting before putting on headphones, earbuds, or a headset. For additional safety information, see the *Regulatory, Safety, and Environmental Notices*.

To access this document:

- Select the **Search** icon in the taskbar, type `HP Documentation` in the search box, and then select **HP Documentation**.
- 

To connect wireless headsets to your computer, follow the device manufacturer's instructions.

## Using sound settings

Use sound settings to adjust system volume, change system sounds, or manage audio devices.

### Sound settings

To view or change sound settings, follow these steps.

1. Select the **Search** icon in the taskbar, type `control panel` in the search box, and then select **Control Panel**.
2. Select **Hardware and Sound**, and then select **Sound**.

### Audio settings

Your computer might include an enhanced sound system by Bang & Olufsen, B&O, or another provider. As a result, your computer might include advanced audio features that can be controlled through an audio control panel specific to your sound system.

Use the audio control panel to view and control audio settings.

- Select the **Search** icon in the taskbar, type `audio control` in the search box, and then select the audio control panel for your system.

## Using video

Your computer is a powerful video device that enables you to watch streaming video from your favorite websites and download video and movies to watch on your computer when you are not connected to a network.

To enhance your viewing enjoyment, use one of the video ports on the computer to connect an external monitor, projector, or TV.

---

 **IMPORTANT:** Be sure that the external device is connected to the correct port on the computer, using the correct cable. Follow the device manufacturer's instructions.

---

For information about using your USB Type-C features, go to <http://www.hp.com/support>, and follow the instructions to find your product.

## Connecting a Thunderbolt device using a USB Type-C cable

To see video or high-resolution display output on an external Thunderbolt device, connect the Thunderbolt device according to the instructions.

---

 **NOTE:** To connect a USB Type-C Thunderbolt™ device to your computer, you need a USB Type-C cable, purchased separately.

---

1. Connect one end of the USB Type-C cable to the USB Type-C Thunderbolt port on the computer.

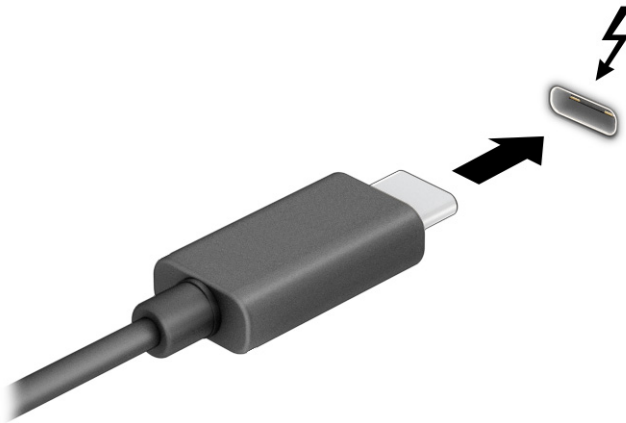

2. Connect the other end of the cable to the external Thunderbolt device.
3. Press the Windows key + **p** to cycle through one of four display states:
  - **PC screen only:** View the screen image on the computer only.
  - **Duplicate:** View the screen image simultaneously on both the computer and external device.
  - **Extend:** View the screen image extended across both the computer and external device.
  - **Second screen only:** View the screen image on the external device only.

Each time you press the Windows key + **p**, the display state changes.

---

 **NOTE:** For best results, especially if you choose the **Extend** option, increase the screen resolution of the external device, as follows. Select the **Start** button, select **Settings**, select **System**, and then select **Display**. Under **Scale & layout**, select the appropriate resolution, and then select **Keep changes**.

---

## Discovering and connecting to Miracast-compatible wireless displays (select products only)

Follow these steps to discover and connect to Miracast®-compatible wireless displays without leaving your current apps.

1. Select the **Search** icon in the taskbar, type `connect` in the search box, and then select **Connect to a wireless display**.
2. Under **Scale & layout**, select **Connect** next to **Connect to a wireless display**.
3. Select a setting, and then follow the on-screen instructions.

## Using data transfer

Your computer is a powerful entertainment device that enables you to transfer photos, videos, and movies from your USB devices to view on your computer.

To enhance your viewing enjoyment, use one of the USB Type-C ports on the computer to connect a USB device, such as a cell phone, camera, activity tracker, or smartwatch, and transfer the files to your computer.

---

 **IMPORTANT:** Be sure that the external device is connected to the correct port on the computer, using the correct cable. Follow the device manufacturer's instructions.

---

For information about using your USB Type-C features, go to <http://www.hp.com/support>, and follow the instructions to find your product.

## Connecting devices to a USB Type-C port (select products only)

To connect a USB Type-C device to your computer, you need a USB Type-C cable, purchased separately.

1. Connect one end of the USB Type-C cable to the USB Type-C port on the computer.

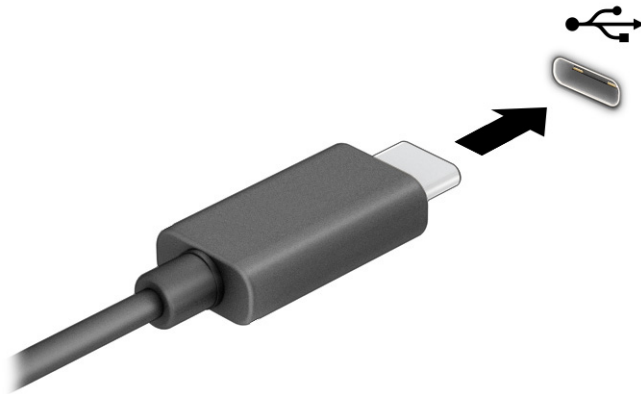

2. Connect the other end of the cable to the external device.

---

## 5 Navigating the screen

Depending on your computer model, you can navigate the computer screen using one or more methods.

- Use touch gestures directly on the computer screen.
- Use touch gestures on the touchpad.
- Use an optional mouse or keyboard (purchased separately).
- Use an on-screen keyboard.
- Use a pointing stick.

### Using touchpad and touch screen gestures

The touchpad helps you navigate the computer screen and control the pointer using simple touch gestures. You can also use the left and right touchpad buttons as you would use the corresponding buttons on an external mouse. To navigate a touch screen (select products only), touch the screen directly using gestures described in this chapter.

To customize gestures and see videos of how they work, select the **Search** icon in the taskbar, type `control panel` in the search box, select **Control Panel**, and then select **Hardware and Sound**. Under **Devices and Printers**, select **Mouse**.

Some products include a precision touchpad, which provides enhanced gesture functionality. To determine if you have a precision touchpad and find additional information, select **Start**, select **Settings**, select **Bluetooth & devices**, and then select **Touchpad**.

---

 **NOTE:** Unless noted, gestures can be used on both the touchpad and a touch screen.

---

#### Tap

Point to an item on the screen, and then tap one finger on the touchpad zone or touch screen to select the item. Double-tap an item to open it.



#### Two-finger pinch zoom

Use the two-finger pinch zoom to zoom out or in on images or text.

- Zoom out by placing two fingers apart on the touchpad zone or touch screen and then moving your fingers together.



- Zoom in by placing two fingers together on the touchpad zone or touch screen and then moving your fingers apart.

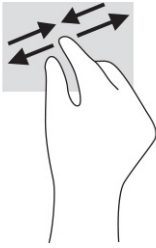

## Two-finger slide (touchpad and precision touchpad)

Place two fingers slightly apart on the touchpad zone and then drag them up, down, left, or right to move up, down, or sideways on a page or image.

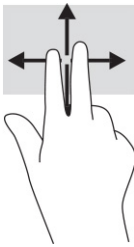

## Two-finger tap (touchpad and precision touchpad)

Tap two fingers on the touchpad zone to open the options menu for the selected object.



**NOTE:** The two-finger tap performs the same function as right-clicking with a mouse.

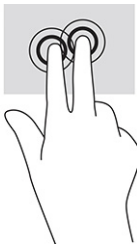

## Three-finger tap (touchpad and precision touchpad)

By default, the three-finger tap opens the taskbar search box. Tap three fingers on the touchpad zone to perform the gesture.

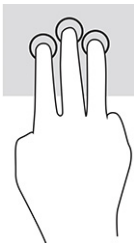

To change the function of this gesture on a precision touchpad, select **Start**, select **Settings**, select **Bluetooth & devices**, and then select **Touchpad**. Under **Three-finger gestures**, in the **Taps** box, select a gesture setting.

## Four-finger tap (touchpad and precision touchpad)

By default, the four-finger tap opens the Action Center. Tap four fingers on the touchpad zone to perform the gesture.

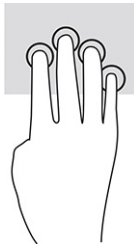

To change the function of this gesture on a precision touchpad, select **Start**, select **Settings**, select **Bluetooth & devices**, and then select **Touchpad**. Under **Four-finger gestures**, in the **Taps** box, select a gesture setting.

## Three-finger swipe (touchpad and precision touchpad)

By default, the three-finger swipe switches between open apps and the desktop.

- Swipe 3 fingers away from you to see all open windows.
- Swipe 3 fingers toward you to show the desktop.
- Swipe 3 fingers left or right to switch between open windows.



To change the function of this gesture on a precision touchpad, select **Start**, select **Settings**, select **Bluetooth & devices**, and then select **Touchpad**. Under **Three-finger gestures**, in the **Swipes** box, select a gesture setting.

## Four-finger swipe (precision touchpad)

By default, the four-finger swipe switches between open desktops.

- Swipe 4 fingers away from you to see all open windows.
- Swipe 4 fingers toward you to show the desktop.
- Swipe 4 fingers left or right to switch between desktops.

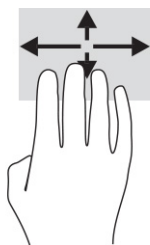

To change the function of this gesture, select **Start**, select **Settings**, select **Bluetooth & devices**, and then select **Touchpad**. Under **Four-finger gestures**, in the **Swipes** box, select a gesture setting.

## One-finger slide (touch screen)

Use the one-finger slide to pan or scroll through lists and pages, or to move an object.

- To scroll across the screen, lightly slide one finger across the screen in the direction you want to move.
- To move an object, press and hold your finger on an object, and then drag your finger to move the object.

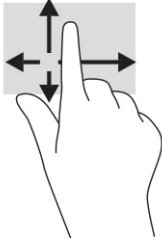

## Using an optional keyboard or mouse

An optional keyboard or mouse allows you to type, select items, scroll, and perform the same functions as you do using touch gestures. The keyboard also allows you to use action keys and hot keys to perform specific functions.

## Using an on-screen keyboard (select products only)

Select products have an on-screen keyboard.

1. To display an on-screen keyboard, tap the keyboard icon in the notification area, at the far right of the taskbar.
2. Begin typing.



---

**NOTE:** Suggested words might be displayed above the on-screen keyboard. Tap a word to select it.



---

**NOTE:** Action keys and hot keys do not display or function on the on-screen keyboard.

---

## 6 Managing power

Your computer can operate on either battery power or external power. When the computer is running on battery power and an external power source is not available to charge the battery, it is important to monitor and conserve the battery charge.

Some power management features described in this chapter might not be available on your computer.

### Using Sleep and Hibernation

Windows has two power-saving states, Sleep and Hibernation.

 **IMPORTANT:** Several well-known vulnerabilities exist when a computer is in the Sleep state. To prevent an unauthorized user from accessing data on your computer, even encrypted data, HP recommends that you always initiate Hibernation instead of Sleep anytime the computer will be out of your physical possession. This practice is particularly important when you travel with your computer.

 **IMPORTANT:** To reduce the risk of possible audio and video degradation, loss of audio or video playback functionality, or loss of information, do not initiate Sleep while reading from or writing to a disc or an external media card.

- Sleep—The Sleep state is automatically initiated after a period of inactivity. Your work is saved to memory, allowing you to resume your work very quickly. You can also initiate Sleep manually. For more information, see [Initiating and exiting Sleep on page 31](#).
- Hibernation—The Hibernation state is automatically initiated if the battery reaches a critical level or the computer has been in the Sleep state for an extended period of time. In the Hibernation state, your work is saved to a hibernation file and the computer powers down. You can also initiate Hibernation manually. For more information, see [Initiating and exiting Hibernation \(select products only\) on page 32](#).

### Initiating and exiting Sleep

You can initiate Sleep several ways.

- Select the **Start** button, select the **Power** icon, and then select **Sleep**.
- Close the display (select products only).
- Press the Sleep hot key (select products only); for example, **fn+f1** or **fn+f12**.
- Briefly press the power button (select products only).

You can exit Sleep in any of the following ways:

- Briefly press the power button.
- If the computer is closed, raise the display (select products only).
- Press a key on the keyboard (select products only).
- Tap the touchpad (select products only).

- Double-tap the touch screen (select products only).

---

 **NOTE:** This feature is available in stand, tent, and tablet modes but not in clamshell mode.

---

When the computer exits Sleep, your work returns to the screen.

 **NOTE:** If you have set a password to be required on exiting Sleep, you must enter your Windows password before your work returns to the screen.

---

## Initiating and exiting Hibernation (select products only)

You can enable user-initiated Hibernation and change other power settings and timeouts using Power and sleep settings.

1. Select the **Search** icon in the taskbar, type `power`, and then select **Choose a power plan**.
2. In the left pane, select **Choose what the power buttons do** (wording might vary by product).
3. Depending on your product, you can enable Hibernation for battery power or external power in any of the following ways:
  - **Power button**—Under **Power and sleep buttons and lid settings** (wording might vary by product), select **When I press the power button**, and then select **Hibernate**.
  - **Sleep button** (select products only)—Under **Power and sleep buttons and lid settings** (wording might vary by product), select **When I press the sleep button**, and then select **Hibernate**.
  - **Lid** (select products only)—Under **Power and sleep buttons and lid settings** (wording might vary by product), select **When I close the lid**, and then select **Hibernate**.
  - **Power menu**—Select **Change Settings that are currently unavailable**, and then, under **Shutdown settings**, select the **Hibernate** check box.

The Power menu can be accessed by selecting the **Start** button.

4. Select **Save changes**.

To initiate Hibernation, use the method that you enabled in step 3.

To exit Hibernation, briefly press the power button.

---

 **NOTE:** If you have set a password to be required on exiting Hibernation, you must enter your Windows password before your work returns to the screen.

---

## Shutting down (turning off) the computer

The Shut down command closes all open programs, including the operating system, and then turns off the display and the computer.

---

 **IMPORTANT:** Unsaved information is lost when the computer shuts down. Be sure to save your work before shutting down the computer.

---

Shut down the computer when it will be unused and disconnected from external power for an extended period.

The recommended procedure is to use the Windows Shut down command.

---

 **NOTE:** If the computer is in the Sleep state or in Hibernation, first exit Sleep or Hibernation by briefly pressing the power button.

---

1. Save your work and close all open programs.
2. Select the **Start** button, select the **Power** icon, and then select **Shut down**.



If the computer is unresponsive and you are unable to use the preceding shutdown procedures, try the following emergency procedures in the sequence provided:

- Press **ctrl+alt+delete**, select the **Power** icon, and then select **Shut down**.
- Press and hold the power button for at least 10 seconds.
- If your computer has a user-replaceable battery (select products only), disconnect the computer from external power, and then remove the battery.

## Using the Power icon

Different Power icons indicate whether the computer is running on battery or external power. Placing the mouse pointer over the icon reveals a message if the battery has reached a low or critical battery level.

The Power icon  is located on the Windows taskbar. The Power icon allows you to quickly access power settings and view the remaining battery charge.

- To view the percentage of remaining battery charge, place the mouse pointer over the **Power** icon .
- To view power and battery settings, right-click the **Power** icon , and then select **Power and sleep settings**.

## Running on battery power

When a charged battery is in the computer and the computer is not plugged into external power, the computer runs on battery power. When the computer is off and unplugged from external power, the battery in the computer slowly discharges. The computer displays a message when the battery reaches a low or critical battery level.

---

 **WARNING!** To reduce potential safety issues, use only the battery provided with the computer, a replacement battery provided by HP, or a compatible battery purchased from HP.

---

Computer battery life varies, depending on power management settings, programs running on the computer, screen brightness, external devices connected to the computer, and other factors.

---

 **NOTE:** Select computer products can switch between graphic controllers to conserve battery charge.

---

## Using HP Fast Charge (select products only)

The HP Fast Charge feature allows you to quickly charge your computer battery. The charging time might vary by  $\pm 10\%$ . When the remaining battery charge is between 0 and 50%, the battery will charge to 50% of full capacity in no more than 30 to 45 minutes, depending on your computer model.

To use HP Fast Charge, shut down your computer, and then connect the AC adapter to your computer and to external power.

## Displaying battery charge

When you are using your computer while running on battery power only, periodically check the battery charge.

To view the percentage of remaining battery charge, place the mouse pointer over the **Power** icon .

## Finding battery information in HP Support Assistant (select products only)

You can access battery information in several ways.

1. Select the **Search** icon in the taskbar, type `support` in the search box, and then select the **HP Support Assistant** app.

– or –

Select the question mark icon in the taskbar.

2. Select **Fixes & Diagnostics**, select **Check your battery**, and then select **Launch**. If HP Battery Check indicates that your battery should be replaced, contact support.

HP Support Assistant provides the following tools and information about the battery:

- HP Battery Check
- Information about battery types, specifications, life cycles, and capacity

## Conserving battery power

Be sure to conserve battery power and maximize battery life.

- Lower the brightness of the display.
- Turn off wireless devices when you are not using them.
- Disconnect unused external devices that are not plugged into an external power source, such as an external hard drive connected to a USB port.
- Stop, disable, or remove any external media cards that you are not using.
- Before you leave your work, initiate Sleep or shut down the computer.

## Identifying low battery levels

When a battery that is the sole power source for the computer reaches a low or critical battery level, the battery light and power icon indicate a low battery level.

- The battery light (select products only) indicates a low or critical battery level.

– or –

- The Power icon  shows a low or critical battery notification.



**NOTE:** For additional information about the Power icon, see [Using the Power icon on page 33](#).

The computer takes the following actions for a critical battery level:

- If Hibernation is disabled and the computer is on or in the Sleep state, the computer remains briefly in the Sleep state and then shuts down and loses any unsaved information.
- If Hibernation is enabled and the computer is on or in the Sleep state, the computer initiates Hibernation.

## Resolving a low battery level

You can quickly resolve low battery level conditions.

### Resolving a low battery level when external power is available

Connect one of the following to the computer and to external power.

- AC adapter
- Optional docking device or expansion product
- Optional power adapter purchased as an accessory from HP

### Resolving a low battery level when no power source is available

Save your work and shut down the computer.

### Resolving a low battery level when the computer cannot exit Hibernation

When the battery level is low and you cannot bring the computer out of Hibernation, connect the AC adapter.

1. Connect the AC adapter to the computer and to external power.
2. Exit Hibernation by pressing the power button.

## Factory-sealed battery

To monitor the status of the battery, or if the battery is no longer holding a charge, run HP Battery Check in the HP Support Assistant app (select products only).

1. Select the **Search** icon in the taskbar, type `support` in the search box, and then select the **HP Support Assistant** app.

– or –

Select the question mark icon in the taskbar.

2. Select **Fixes & Diagnostics**, select **Check your battery**, and then select **Launch**. If HP Battery Check indicates that your battery should be replaced, contact support.

The battery[ies] in this product cannot be easily replaced by users themselves. Removing or replacing the battery could affect your warranty coverage. If a battery is no longer holding a charge, contact support.

## Running on external power

For information about connecting to external power, see the *Setup Instructions* poster provided in the computer box.



The computer does not use battery power when the computer is connected to external power with an approved AC adapter or an optional docking device or expansion product.

---

**⚠ WARNING!** To reduce potential safety issues, use only the AC adapter provided with the computer, a replacement AC adapter provided by HP, or a compatible AC adapter purchased from HP.

**⚠ WARNING!** Do not charge the computer battery while you are aboard aircraft.

---

Connect the computer to external power under any of the following conditions:

- When charging or calibrating a battery
- When installing or updating system software
- When updating the system BIOS
- When writing information to a disc (select products only)
- When running Disk Defragmenter on computers with internal hard drives
- When performing a backup or recovery

When you connect the computer to external power:

- The battery begins to charge.
- The Power icon  changes appearance.

When you disconnect external power:

- The computer switches to battery power.
- The Power icon  changes appearance.

---

# 7 Maintaining your computer

Performing regular maintenance keeps your computer in optimal condition. This chapter explains how to use tools like Disk Defragmenter and Disk Cleanup. It also provides instructions for updating programs and drivers, steps to clean the computer, and tips for traveling with (or shipping) the computer.

## Improving performance

You can improve the performance of your computer by performing regular maintenance tasks with tools such as Disk Defragmenter and Disk Cleanup.

### Using Disk Defragmenter

HP recommends using Disk Defragmenter to defragment your hard drive at least once a month.



---

**NOTE:** It is not necessary to run Disk Defragmenter on solid-state drives.

---

To run Disk Defragmenter:

1. Connect the computer to AC power.
2. Select the **Search** icon in the taskbar, type `defragment` in the search box, and then select **Defragment and Optimize Drives**.
3. Follow the on-screen instructions.

For additional information, access the Disk Defragmenter software Help.

### Using Disk Cleanup

Use Disk Cleanup to search the hard drive for unnecessary files that you can safely delete to free up disk space and help the computer run more efficiently.

To run Disk Cleanup:

1. Select the **Search** icon in the taskbar, type `disk` in the search box, and then select **Disk Cleanup**.
2. Follow the on-screen instructions.

### Using HP 3D DriveGuard (select products only)

HP 3D DriveGuard protects a hard drive by parking the drive and halting data requests under some conditions.

- You drop the computer.
- You move the computer with the display closed while the computer is running on battery power.

A short time after one of these events, HP 3D DriveGuard returns the hard drive to normal operation.



---

**NOTE:** Only internal hard drives are protected by HP 3D DriveGuard. A hard drive installed in an optional docking device or connected to a USB port is not protected by HP 3D DriveGuard.

---



**NOTE:** Because solid-state drives (SSDs) lack moving parts, HP 3D DriveGuard is unnecessary for these drives.

---

## Identifying HP 3D DriveGuard status

The hard drive light on the computer changes color to show that the drive in a primary hard drive bay, the secondary hard drive bay (select products only), or both are parked.

## Updating programs and drivers

HP recommends that you update your programs and drivers on a regular basis. Updates can resolve issues and bring new features and options to your computer. For example, older graphics components might not work well with the most recent gaming software. Without the latest driver, you do not get the most out of your equipment.

Depending on your operating system, you can use the following methods to update programs and drivers:

- [Updating both programs and drivers on page 38](#)
- [Updating programs only on page 38](#)
- [Updating drivers only on page 38](#)

## Updating both programs and drivers

Use this procedure to update both programs and drivers.

1. Select the **Search** icon in the taskbar, type `support` in the search box, and then select the **HP Support Assistant** app.  
– or –  
Select the question mark icon in the taskbar.
2. Under **My notebook**, select **Updates**. The **Software and Drivers** window opens, and Windows checks for updates.
3. Follow the on-screen instructions.

## Updating programs only

Use this procedure to update programs only.

1. Select **Start**, and then select **Microsoft Store**.
2. Select the dots next to your profile picture in the top-right corner, and then select **Downloads and updates**.
3. On the **Downloads and updates** page, select **Get updates**, and then follow the on-screen instructions.

## Updating drivers only

Use this procedure to update drivers only.

1. Select the **Search** icon in the taskbar, type `windows update settings` in the search box, and then select **Windows Update settings**.

2. Select **Check for updates**, and then follow the on-screen instructions.



---

**NOTE:** If Windows does not find a new driver, go to the device manufacturer's website, and follow the instructions.

---

## Cleaning your computer

Cleaning your computer regularly removes dirt and debris so that your device continues to operate at its best. Use the following information to safely clean the external surfaces of your computer.

### Enabling HP Easy Clean (select products only)

HP Easy Clean helps you to avoid accidental input while you clean the computer surfaces. This software disables devices such as the keyboard, touch screen, and touchpad for a preset amount of time so that you can clean all computer surfaces.

1. Start HP Easy Clean in one of the following ways:
  - Select the **Start** menu, and then select **HP Easy Clean**.  
– or –
  - Select the **HP Easy Clean** icon in the taskbar.  
– or –
  - Select **Start**, and then select the **HP Easy Clean** tile.
2. Now that your device is disabled for a short period, see [Removing dirt and debris from your computer on page 39](#) for the recommended steps to clean the high-touch, external surfaces on your computer. After you remove the dirt and debris, you can also clean the surfaces with a disinfectant. See [Cleaning your computer with a disinfectant on page 40](#) for guidelines to help prevent the spread of harmful bacteria and viruses.

### Removing dirt and debris from your computer

Here are the recommended steps to clean dirt and debris from your computer.

For computers with wood veneer, see [Caring for wood veneer \(select products only\) on page 41](#).

1. Wear disposable gloves made of latex (or nitrile gloves, if you are latex-sensitive) when cleaning the surfaces.
2. Turn off your device and unplug the power cord and other connected external devices. Remove any installed batteries from items such as wireless keyboards.



---

**CAUTION:** To prevent electric shock or damage to components, never clean a product while it is turned on or plugged in.

---

3. Moisten a microfiber cloth with water. The cloth should be moist, but not dripping wet.



---

**IMPORTANT:** To avoid damaging the surface, avoid abrasive cloths, towels, and paper towels.

---

4. Wipe the exterior of the product gently with the moistened cloth.



---

**IMPORTANT:** Keep liquids away from the product. Avoid getting moisture in any openings. If liquid makes its way inside your HP product, it can cause damage to the product. Do not spray liquids directly

on the product. Do not use aerosol sprays, solvents, abrasives, or cleaners containing hydrogen peroxide or bleach that might damage the finish.

---

5. Start with the display (if applicable). Wipe carefully in one direction, and move from the top of the display to the bottom. Finish with any flexible cables, like power cord, keyboard cable, and USB cables.
6. Be sure that surfaces have completely air-dried before turning the device on after cleaning.
7. Discard the gloves after each cleaning. Clean your hands immediately after you remove the gloves.

See [Cleaning your computer with a disinfectant on page 40](#) for recommended steps to clean the high-touch, external surfaces on your computer to help prevent the spread of harmful bacteria and viruses.

## Cleaning your computer with a disinfectant

The World Health Organization (WHO) recommends cleaning surfaces, followed by disinfection, as a best practice for preventing the spread of viral respiratory illnesses and harmful bacteria.

After cleaning the external surfaces of your computer using the steps in [Removing dirt and debris from your computer on page 39](#), [Caring for wood veneer \(select products only\) on page 41](#), or both, you might also choose to clean the surfaces with a disinfectant. A disinfectant that is within HP's cleaning guidelines is an alcohol solution consisting of 70% isopropyl alcohol and 30% water. This solution is also known as rubbing alcohol and is sold in most stores.

Follow these steps when disinfecting high-touch, external surfaces on your computer:

1. Wear disposable gloves made of latex (or nitrile gloves, if you are latex-sensitive) when cleaning the surfaces.
2. Turn off your device and unplug the power cord and other connected external devices. Remove any installed batteries from items such as wireless keyboards.

---

 **CAUTION:** To prevent electric shock or damage to components, never clean a product while it is turned on or plugged in.

---

3. Moisten a microfiber cloth with a mixture of 70% isopropyl alcohol and 30% water. The cloth should be moist, but not dripping wet.

---

 **CAUTION:** Do not use any of the following chemicals or any solutions that contain them, including spray-based surface cleaners: bleach, peroxides (including hydrogen peroxide), acetone, ammonia, ethyl alcohol, methylene chloride, or any petroleum-based materials, such as gasoline, paint thinner, benzene, or toluene.

---

 **IMPORTANT:** To avoid damaging the surface, avoid abrasive cloths, towels, and paper towels.

---

4. Wipe the exterior of the product gently with the moistened cloth.

---

 **IMPORTANT:** Keep liquids away from the product. Avoid getting moisture in any openings. If liquid makes its way inside your HP product, it can cause damage to the product. Do not spray liquids directly on the product. Do not use aerosol sprays, solvents, abrasives, or cleaners containing hydrogen peroxide or bleach that might damage the finish.

---

5. Start with the display (if applicable). Wipe carefully in one direction, and move from the top of the display to the bottom. Finish with any flexible cables, like power cord, keyboard cable, and USB cables.
6. Be sure that surfaces have completely air-dried before turning the device on after cleaning.

7. Discard the gloves after each cleaning. Clean your hands immediately after you remove the gloves.

## Caring for wood veneer (select products only)

Your product might feature high-quality wood veneer. As with all natural wood products, proper care is important for best results over the life of the product. Because of the nature of natural wood, you might see unique variations in the grain pattern or subtle variations in color, which are normal.

- Clean the wood with a dry, static-free microfiber cloth or chamois.
- Avoid cleaning products containing substances such as ammonia, methylene chloride, acetone, turpentine, or other petroleum-based solvents.
- Do not expose the wood to sun or moisture for long periods of time.
- If the wood becomes wet, dry it by dabbing with an absorbent, lint-free cloth.
- Avoid contact with any substance that might dye or discolor the wood.
- Avoid contact with sharp objects or rough surfaces that might scratch the wood.

See [Removing dirt and debris from your computer on page 39](#) for the recommended steps to clean the high-touch, external surfaces on your computer. After you remove the dirt and debris, you can also clean the surfaces with a disinfectant. See [Cleaning your computer with a disinfectant on page 40](#) for sanitizing guidelines to help prevent the spread of harmful bacteria and viruses.

## Traveling with or shipping your computer

If you must travel with or ship your computer, follow these tips to keep your equipment safe.

- Prepare the computer for traveling or shipping:
  - Back up your information to an external drive.
  - Remove all discs and all external media cards, such as memory cards.
  - Turn off and then disconnect all external devices.
  - Shut down the computer.
- Take a backup of your information. Keep the backup separate from the computer.
- When traveling by air, carry the computer as hand luggage; do not check it with the rest of your luggage.

---

 **IMPORTANT:** Avoid exposing a drive to magnetic fields. Security devices with magnetic fields include airport walk-through devices and security wands. Airport conveyer belts and similar security devices that check carry-on baggage use X-rays instead of magnetism and do not damage drives.

---

- If you plan to use the computer during a flight, listen for the in-flight announcement that tells you when you can use your computer. In-flight computer use is at the discretion of the airline.
- If you are shipping the computer or a drive, use suitable protective packaging and label the package “FRAGILE.”
- The use of wireless devices might be restricted in some environments. Such restrictions might apply aboard aircraft, in hospitals, near explosives, and in hazardous locations. If you are uncertain of the policy that applies to the use of a wireless device in your computer, ask for authorization to use your computer before you turn it on.

- If you are traveling internationally, follow these suggestions:
  - Check the computer-related customs regulations for each country or region on your itinerary.
  - Check the power cord and adapter requirements for each location in which you plan to use the computer. Voltage, frequency, and plug configurations vary.

---

 **WARNING!** To reduce the risk of electric shock, fire, or damage to the equipment, do not attempt to run the computer from a voltage converter kit that is sold for appliances.

---

# 8 Securing your computer and information

Computer security is essential for protecting the confidentiality, integrity, and availability of your information. Standard security solutions provided by the Windows operating system, HP applications, the Setup Utility (BIOS), and other third-party software can help protect your computer from a variety of risks, such as viruses, worms, and other types of malicious code.

 **NOTE:** Some security features listed in this chapter may not be available on your computer.

## Using passwords

A password is a group of characters that you choose to secure your computer information and to protect online transactions. You can set several types of passwords. For example, when you set up your computer for the first time, you were asked to create a user password to secure your computer. You can set additional passwords in Windows or in HP Setup Utility (BIOS), which is preinstalled on your computer.

You may find it helpful to use the same password for a Setup Utility (BIOS) feature and for a Windows security feature.

To create and save passwords, use the following tips:

- To reduce the risk of being locked out of the computer, record each password and store it in a secure place away from the computer. Do not store passwords in a file on the computer.
- When creating passwords, follow requirements set by the program.
- Change your passwords at least every 3 months.
- An ideal password is long and has letters, punctuation, symbols, and numbers.
- Before you send your computer for service, back up your files, delete confidential files, and then remove all password settings.

 **NOTE:** For additional information about Windows passwords, such as screen-saver passwords:

Select the **Search** icon in the taskbar, type `support` in the search box, and then select the **HP Support Assistant** app.

– or –

Select the question mark icon in the taskbar.

## Setting Windows passwords

Windows passwords can help protect your computer from unauthorized access.

**Table 8-1** Types of Windows passwords and their functions

Password	Function
User password	Protects access to a Windows user account.



**Table 8-1** Types of Windows passwords and their functions (continued)

Password	Function
Administrator password	Protects administrator-level access to computer contents.

**NOTE:** This password cannot be used to access Setup Utility (BIOS) contents.

## Setting Setup Utility (BIOS) passwords

BIOS passwords provide additional layers of security for your computer.

**Table 8-2** Types of BIOS passwords and their functions

Password	Function
Administrator password	<ul style="list-style-type: none"><li>• Must be entered each time you access Setup Utility (BIOS).</li><li>• If you forget your administrator password, you cannot access Setup Utility (BIOS).</li></ul>
Power-on password	<ul style="list-style-type: none"><li>• Must be entered each time you turn on or restart the computer.</li><li>• If you forget your power-on password, you cannot turn on or restart the computer.</li></ul>

To set, change, or delete an administrator or power-on password in Setup Utility (BIOS):

 **IMPORTANT:** Use extreme care when making changes in Setup Utility (BIOS). Errors can prevent the computer from operating properly.

1. Start Setup Utility (BIOS):
  - Computers or tablets with keyboards:
    - Turn on or restart the computer, quickly press **esc**, and then press **f10**.
  - Tablets without keyboards:
    - a. Turn on or restart the tablet, and then quickly hold down the volume up button.
      - or -
      - Turn on or restart the tablet, and then quickly hold down the volume down button.
      - or -
      - Turn on or restart the tablet, and then quickly hold down the Windows button.
    - b. Tap **f10**.
2. Select **Security**, and then follow the on-screen instructions.

To save your changes, select **Exit**, select **Save Changes and Exit**, and then select **Yes**.

 **NOTE:** If you are using arrow keys to highlight your choice, you must then press **enter**.

Your changes take effect when the computer restarts.

## Using Windows Hello (select products only)

On products equipped with a fingerprint reader or an infrared camera, Windows Hello allows you to enroll your fingerprint, your facial ID, and set up a PIN. After enrollment, you can use your fingerprint reader, facial ID, or PIN to sign in to Windows.

To set up Windows Hello:

1. Select the **Start** button, select **Settings**, select **Accounts**, and then select **Sign-in options**.
2. If you do not have a password set up, you must add one before you can use other sign-in options. Select **Password**, and then select **Add**.
3. Select **Facial recognition (Windows Hello)** or **Fingerprint recognition (Windows Hello)**, and then select **Set up**.
4. Select **Get started**, and then follow the on-screen instructions to enroll your fingerprint or facial ID and set up a PIN.

---

 **IMPORTANT:** To prevent fingerprint logon issues, be sure when you register your fingerprint that all sides of your finger are registered by the fingerprint reader.

 **NOTE:** The PIN is not limited in length. The default setting is for numbers only. To include alphabetic or special characters, select the **include letters and symbols** check box.

---

## Using internet security software

When you use your computer to access email, a network, or the internet, you potentially expose your computer to computer viruses, spyware, and other online threats. To help protect your computer, internet security software that includes antivirus and firewall features may be preinstalled on your computer as a trial offer. To provide ongoing protection against newly discovered viruses and other security risks, security software must be kept up to date. HP strongly recommends that you upgrade the security software trial offer or purchase the software of your choice to fully protect your computer.

### Using antivirus software

Computer viruses can disable programs, utilities, or the operating system, or cause them to function abnormally. Antivirus software can detect most viruses, destroy them, and in most cases, repair any damage that they cause.

To provide ongoing protection against newly discovered viruses, antivirus software must be kept up to date.

An antivirus program may be preinstalled on your computer. HP strongly recommends that you use the antivirus program of your choice to fully protect your computer.

For more information about computer viruses, select the **Search** icon in the taskbar, type `support` in the search box, and then select the **HP Support Assistant** app.

– or –

Select the question mark icon in the taskbar.

### Using firewall software

Firewalls are designed to prevent unauthorized access to a system or network. A firewall can be software you install on your computer, network, or both, or it can be a combination of both hardware and software.

There are two types of firewalls to consider:

- Host-based firewalls—Software that protects only the computer it is installed on.
- Network-based firewalls—Installed between your DSL or cable modem and your home network to protect all the computers on the network.

When a firewall is installed on a system, all data sent to and from the system is monitored and compared with a set of user-defined security criteria. Any data that does not meet those criteria is blocked.

## Installing software updates

HP, Windows, and third-party software installed on your computer should be regularly updated to correct security problems and improve software performance.

---

 **IMPORTANT:** Microsoft sends out alerts regarding Windows updates, which may include security updates. To protect the computer from security breaches and computer viruses, install all updates from Microsoft as soon as you receive an alert.

---

You can install these updates automatically.

To view or change the settings:

1. Select the **Start** button, select **Settings**, and then select **Windows Update**.
2. Follow the on-screen instructions.
3. To schedule a time for installing updates, select **Advanced options**, and then follow the on-screen instructions.

## Using HP TechPulse (select products only)

HP TechPulse is a cloud-based IT solution that enables businesses to effectively manage and secure their company assets.

HP TechPulse helps protect devices against malware and other attacks, monitors device health, and helps reduce time spent solving device and security issues. You can quickly download and install the software, which is highly cost-effective relative to traditional in-house solutions. For more information, go to <https://www.hpdaas.com/>.

## Securing your wireless network

When you set up a WLAN or access an existing WLAN, always enable security features to protect your network from unauthorized access. WLANs in public areas (hotspots) like coffee shops and airports may not provide any security.

## Backing up your software applications and information

Regularly back up your software applications and information to protect them from being permanently lost or damaged through a virus attack or a software or hardware failure.

## Using an optional security cable (select products only)

A security cable (purchased separately) is designed to act as a deterrent, but it may not prevent the computer from being mishandled or stolen. To connect a security cable to your computer, follow the device manufacturer's instructions.

---

## 9 Using Setup Utility (BIOS)

Setup Utility, or Basic Input/Output System (BIOS), controls communication between all the input and output devices on the system (such as disk drives, display, keyboard, mouse, and printer). Setup Utility (BIOS) includes settings for the types of devices installed, the startup sequence of the computer, and the amount of system and extended memory.

---

 **NOTE:** To start Setup Utility on convertible computers, your computer must be in notebook mode and you must use the keyboard attached to your notebook.

---

### Starting Setup Utility (BIOS)

You have several ways to access the Setup Utility (BIOS).

---

 **IMPORTANT:** Use extreme care when making changes in Setup Utility (BIOS). Errors can prevent the computer from operating properly.

---

- Turn on or restart the computer and quickly press **f10**.

– or –

Turn on or restart the computer, quickly press **esc**, and then press **f10** when the Start menu is displayed.

### Updating Setup Utility (BIOS)

Updated versions of Setup Utility (BIOS) might be available on the HP website. Most BIOS updates on the HP website are packaged in compressed files called *SoftPaqs*. Some download packages contain a file named *Readme.txt*, which contains information regarding installing and troubleshooting the file.

### Determining the BIOS version

To decide whether you need to update Setup Utility (BIOS), first determine the BIOS version on your computer.

To reveal the BIOS version information (also known as *ROM date* and *System BIOS*), use one of these options.

- HP Support Assistant
  1. Select the **Search** icon in the taskbar, type `support` in the search box, and then select the **HP Support Assistant** app.

– or –

Select the question mark icon in the taskbar.
  2. Under **My notebook**, select **Specifications**.
- Setup Utility (BIOS)
  1. Start Setup Utility (BIOS) (see [Starting Setup Utility \(BIOS\) on page 48](#)).
  2. Select **Main**, and then make note of the BIOS version.

3. Select **Exit**, select one of the options, and then follow the on-screen instructions.
- In Windows, press **ctrl+alt+s**.

To check for later BIOS versions, see [Preparing for a BIOS update on page 49](#).

## Preparing for a BIOS update

Be sure to follow all prerequisites before downloading and installing a BIOS update.

 **IMPORTANT:** To reduce the risk of damage to the computer or an unsuccessful installation, download and install a BIOS update only when the computer is connected to reliable external power using the AC adapter. Do not download or install a BIOS update while the computer is running on battery power, docked in an optional docking device, or connected to an optional power source. During the download and installation, follow these instructions:

- Do not disconnect power from the computer by unplugging the power cord from the AC outlet.
- Do not shut down the computer or initiate Sleep.
- Do not insert, remove, connect, or disconnect any device, cable, or cord.

 **NOTE:** If your computer is connected to a network, consult the network administrator before installing any software updates, especially system BIOS updates.

## Downloading a BIOS update

After you review the prerequisites, you can check for and download BIOS updates.

1. Select the **Search** icon in the taskbar, type `support` in the search box, and then select the **HP Support Assistant** app.  
– or –  
Select the question mark icon in the taskbar.
2. Select **Updates**. The **Checking for Updates** window opens, and Windows checks for updates.
3. Follow the on-screen instructions.
4. At the download area, follow these steps:
  - a. Identify the most recent BIOS update and compare it to the BIOS version currently installed on your computer. If the update is more recent than your BIOS version, make a note of the date, name, or other identifier. You might need this information to locate the update later, after it has been downloaded to your hard drive.
  - b. Follow the on-screen instructions to download your selection to the hard drive.  
  
Make a note of the path to the location on your hard drive where the BIOS update is downloaded. You will need to access this path when you are ready to install the update.

## Installing a BIOS update

BIOS installation procedures vary. Follow any instructions that appear on the screen after the download is complete. If no instructions appear, follow these steps.

1. Select the **Search** icon in the taskbar, type `file` in the search box, and then select **File Explorer**.
2. Select your hard drive designation. The hard drive designation is typically Local Disk (C:).

3. Using the hard drive path you recorded earlier, open the folder that contains the update.
4. Double-click the file that has an .exe extension (for example, *filename.exe*).  
The BIOS installation begins.
5. Complete the installation by following the on-screen instructions.



**NOTE:** After a message on the screen reports a successful installation, you can delete the downloaded file from your hard drive.

---

---

# 10 Using HP PC Hardware Diagnostics

You can use the HP PC Hardware Diagnostics utility to determine whether your computer hardware is running properly. The three versions are HP PC Hardware Diagnostics Windows, HP PC Hardware Diagnostics UEFI (Unified Extensible Firmware Interface), and (for select products only) Remote HP PC Hardware Diagnostics UEFI, a firmware feature.

## Using HP PC Hardware Diagnostics Windows (select products only)

HP PC Hardware Diagnostics Windows is a Windows-based utility that allows you to run diagnostic tests to determine whether the computer hardware is functioning properly. The tool runs within the Windows operating system to diagnose hardware failures.

If HP PC Hardware Diagnostics Windows is not installed on your computer, first you must download and install it. To download HP PC Hardware Diagnostics Windows, see [Downloading HP PC Hardware Diagnostics Windows on page 52](#).

## Using an HP PC Hardware Diagnostics Windows hardware failure ID code

When HP PC Hardware Diagnostics Windows detects a failure that requires hardware replacement, a 24-digit failure ID code is generated for select component tests. For interactive tests, such as keyboard, mouse, or audio and video palette, you must perform troubleshooting steps before you can receive a failure ID.

- You have several options after you receive a failure ID:
  - Select **Next** to open the Event Automation Service (EAS) page, where you can log the case.  
– or –
  - Scan the QR code with your mobile device, which takes you to the EAS page, where you can log the case.  
– or –
  - Select the box next to the 24-digit failure ID to copy your failure code and send it to support.

## Accessing HP PC Hardware Diagnostics Windows

After HP PC Hardware Diagnostics Windows is installed, you can access it from HP Support Assistant or the Start menu.

### Accessing HP PC Hardware Diagnostics Windows from HP Support Assistant

After HP PC Hardware Diagnostics Windows is installed, follow these steps to access it from HP Support Assistant.

1. Select the **Search** icon in the taskbar, type `support` in the search box, and then select the **HP Support Assistant** app.  
– or –  
Select the question mark icon in the taskbar.



2. Select **Fixes & Diagnostics**.
3. Select **Run hardware diagnostics**, and then select **Launch**.
4. When the tool opens, select the type of diagnostic test that you want to run, and then follow the on-screen instructions.

---

 **NOTE:** To stop a diagnostic test, select **Cancel**.

---

## Accessing HP PC Hardware Diagnostics Windows from the Start menu (select products only)

After HP PC Hardware Diagnostics Windows is installed, follow these steps to access it from the Start menu.

1. Select the **Start** button, and then select **All apps**.
2. Select **HP PC Hardware Diagnostics Windows**.
3. When the tool opens, select the type of diagnostic test that you want to run, and then follow the on-screen instructions.

---

 **NOTE:** To stop a diagnostic test, select **Cancel**.

---

## Downloading HP PC Hardware Diagnostics Windows

The HP PC Hardware Diagnostics Windows downloading instructions are provided in English only. You must use a Windows computer to download this tool because only .exe files are provided.

### Downloading the latest HP PC Hardware Diagnostics Windows version from HP

To download HP PC Hardware Diagnostics Windows from HP, follow these steps.

1. Go to <http://www.hp.com/go/techcenter/pcdiags>. The HP PC Diagnostics home page is displayed.
2. Select **Download HP Diagnostics Windows**, and then select the specific Windows diagnostics version to download to your computer or a USB flash drive.

The tool downloads to the selected location.

### Downloading the HP PC Hardware Diagnostics Windows from the Microsoft Store

You can download the HP PC Hardware Diagnostics Windows from the Microsoft Store.

1. Select the Microsoft Store app on your desktop or select the **Search** icon in the taskbar, and then type `Microsoft Store` in the search box.
2. Type `HP PC Hardware Diagnostics Windows` in the **Microsoft Store** search box.
3. Follow the on-screen directions.

The tool downloads to the selected location.

### Downloading HP Hardware Diagnostics Windows by product name or number (select products only)

You can download HP PC Hardware Diagnostics Windows by product name or number.

---

 **NOTE:** For some products, you might have to download the software to a USB flash drive by using the product name or number.

---

1. Go to <http://www.hp.com/support>.
2. Select **Software and Drivers**, select your type of product, and then enter the product name or number in the search box that is displayed.
3. In the **Diagnostics** section, select **Download**, and then follow the on-screen instructions to select the specific Windows diagnostics version to be downloaded to your computer or USB flash drive.

The tool downloads to the selected location.

## Installing HP PC Hardware Diagnostics Windows

To install HP PC Hardware Diagnostics Windows, navigate to the folder on your computer or the USB flash drive where the .exe file downloaded, double-click the .exe file, and then follow the on-screen instructions.

## Using HP PC Hardware Diagnostics UEFI

HP PC Hardware Diagnostics UEFI (Unified Extensible Firmware Interface) allows you to run diagnostic tests to determine whether the computer hardware is functioning properly. The tool runs outside the operating system so that it can isolate hardware failures from issues that are caused by the operating system or other software components.



**NOTE:** For some products, you must use a Windows computer and a USB flash drive to download and create the HP UEFI support environment because only .exe files are provided. For more information, see [Downloading HP PC Hardware Diagnostics UEFI to a USB flash drive on page 54](#).

If your PC does not start in Windows, you can use HP PC Hardware Diagnostics UEFI to diagnose hardware issues.

## Using an HP PC Hardware Diagnostics UEFI hardware failure ID code

When HP PC Hardware Diagnostics UEFI detects a failure that requires hardware replacement, a 24-digit failure ID code is generated.

For assistance in solving the problem:

- Select **Contact HP**, accept the HP privacy disclaimer, and then use a mobile device to scan the failure ID code that appears on the next screen. The HP Customer Support - Service Center page appears with your failure ID and product number automatically filled in. Follow the on-screen instructions.

– or –

Contact support, and provide the failure ID code.



**NOTE:** To start diagnostics on a convertible computer, your computer must be in notebook mode, and you must use the attached keyboard.



**NOTE:** If you need to stop a diagnostic test, press **esc**.

## Starting HP PC Hardware Diagnostics UEFI

To start HP PC Hardware Diagnostics UEFI, follow this procedure.

1. Turn on or restart the computer, and quickly press **esc**.

2. Press **f2**.

The BIOS searches three places for the diagnostic tools, in the following order:

- a. Connected USB flash drive



**NOTE:** To download the HP PC Hardware Diagnostics UEFI tool to a USB flash drive, see [Downloading the latest HP PC Hardware Diagnostics UEFI version on page 54](#).

---

- b. Hard drive
- c. BIOS

3. When the diagnostic tool opens, select the type of diagnostic test that you want to run, and then follow the on-screen instructions.

## Downloading HP PC Hardware Diagnostics UEFI to a USB flash drive

Downloading HP PC Hardware Diagnostics UEFI to a USB flash drive can be useful in some situations.

- HP PC Hardware Diagnostics UEFI is not included in the preinstallation image.
- HP PC Hardware Diagnostics UEFI is not included in the HP Tool partition.
- The hard drive is damaged.



**NOTE:** The HP PC Hardware Diagnostics UEFI downloading instructions are provided in English only, and you must use a Windows computer to download and create the HP UEFI support environment because only .exe files are provided.

---

## Downloading the latest HP PC Hardware Diagnostics UEFI version

To download the latest HP PC Hardware Diagnostics UEFI version to a USB flash drive, follow this procedure.

1. Go to <http://www.hp.com/go/techcenter/pcdiags>. The HP PC Diagnostics home page is displayed.
2. Select **Download HP Diagnostics UEFI**, and then select **Run**.

## Downloading HP PC Hardware Diagnostics UEFI by product name or number (select products only)

You can download HP PC Hardware Diagnostics UEFI by product name or number (select products only) to a USB flash drive.



**NOTE:** For some products, you might have to download the software to a USB flash drive by using the product name or number.

---

1. Go to <http://www.hp.com/support>.
2. Enter the product name or number, select your computer, and then select your operating system.
3. In the **Diagnostics** section, follow the on-screen instructions to select and download the specific UEFI Diagnostics version for your computer.

## Using Remote HP PC Hardware Diagnostics UEFI settings (select products only)

Remote HP PC Hardware Diagnostics UEFI is a firmware (BIOS) feature that downloads HP PC Hardware Diagnostics UEFI to your computer. It can then execute the diagnostics on your computer, and it might upload results to a preconfigured server.

For more information about Remote HP PC Hardware Diagnostics UEFI, go to <http://www.hp.com/go/techcenter/pcdiags>, and then select **Find out more**.

### Downloading Remote HP PC Hardware Diagnostics UEFI

HP Remote PC Hardware Diagnostics UEFI is also available as a SoftPaq that you can download to a server.

### Downloading the latest Remote HP PC Hardware Diagnostics UEFI version

You can download the latest HP PC Hardware Diagnostics UEFI version to a USB flash drive.

1. Go to <http://www.hp.com/go/techcenter/pcdiags>. The HP PC Diagnostics home page is displayed.
2. Select **Download Remote Diagnostics**, and then select **Run**.

### Downloading Remote HP PC Hardware Diagnostics UEFI by product name or number

You can download HP Remote PC Hardware Diagnostics UEFI by product name or number.



**NOTE:** For some products, you might have to download the software by using the product name or number.

1. Go to <http://www.hp.com/support>.
2. Select **Software and Drivers**, select your type of product, enter the product name or number in the search box that is displayed, select your computer, and then select your operating system.
3. In the **Diagnostics** section, follow the on-screen instructions to select and download the **Remote UEFI** version for the product.

### Customizing Remote HP PC Hardware Diagnostics UEFI settings

Using the Remote HP PC Hardware Diagnostics setting in Computer Setup (BIOS), you can perform several customizations.

- Set a schedule for running diagnostics unattended. You can also start diagnostics immediately in interactive mode by selecting **Execute Remote HP PC Hardware Diagnostics**.
- Set the location for downloading the diagnostic tools. This feature provides access to the tools from the HP website or from a server that has been preconfigured for use. Your computer does not require the traditional local storage (such as a hard drive or USB flash drive) to run remote diagnostics.
- Set a location for storing the test results. You can also set the user name and password that you use for uploads.
- Display status information about the diagnostics run previously.

To customize Remote HP PC Hardware Diagnostics UEFI settings, follow these steps:

1. Turn on or restart the computer, and when the HP logo appears, press **f10** to enter Computer Setup.

2. Select **Advanced**, and then select **Settings**.
3. Make your customization selections.
4. Select **Exit**, then select **Save Changes and Exit** to save your settings.

Your changes take effect when the computer restarts.

---

# 11 Backing up, restoring, and recovering

You can use Windows tools or HP software to back up your information, create a restore point, reset your computer, create recovery media, or restore your computer to its factory state. Performing these standard procedures can return your computer to a working state faster.

---

 **IMPORTANT:** If you will be performing recovery procedures on a tablet, the tablet battery must be at least 70% charged before you start the recovery process.

 **IMPORTANT:** For a tablet with a detachable keyboard, connect the tablet to the keyboard base before beginning any recovery process.

---

## Backing up information and creating recovery media

These methods of creating recovery media and backups are available on select products only.

### Using Windows tools for backing up

HP recommends that you back up your information immediately after initial setup. You can do this task either using Windows Backup locally with an external USB flash drive or using online tools.

---

 **IMPORTANT:** Windows is the only option that allows you to back up your personal information. Schedule regular backups to avoid information loss.

 **NOTE:** If computer storage is 32 GB or less, Microsoft® System Restore is disabled by default.

---

### Using the HP Cloud Recovery Download Tool to create recovery media (select products only)

You can use the HP Cloud Recovery Download Tool to create HP Recovery media on a bootable USB flash drive.

For details:

- Go to <http://www.hp.com>, search for HP Cloud Recovery, and then select the result that matches the type of computer that you have.

---

 **NOTE:** If you cannot create recovery media yourself, contact support to obtain recovery discs. Go to <http://www.hp.com/support>, select your country or region, and then follow the on-screen instructions.

 **IMPORTANT:** HP recommends that you follow the [Restoring and recovery methods on page 58](#) to restore your computer before you obtain and use the HP recovery discs. Using a recent backup can return your machine to a working state sooner than using the HP recovery discs. After the system is restored, reinstalling all the operating system software released since your initial purchase can be a lengthy process.

---

## Restoring and recovering your system

You have several tools available to recover your system both within and outside of Windows if the desktop cannot load.

HP recommends that you attempt to restore your system using the [Restoring and recovery methods on page 58](#).

## Creating a system restore

System Restore is available in Windows. The System Restore software can automatically or manually create restore points, or snapshots, of the system files and settings on the computer at a particular point.

When you use System Restore, it returns your computer to its state at the time you made the restore point. Your personal files and documents should not be affected.

## Restoring and recovery methods

After you run the first method, test to see whether the issue still exists before you proceed to the next method, which might now be unnecessary.

1. Run a Microsoft System Restore.
2. Run Reset this PC.



---

**NOTE:** The options **Remove everything** and then **Fully clean the drive** can take several hours to complete and leave no information on your computer. It is the safest way to reset your computer before you recycle it.

---

3. Recover using HP Recovery media. For more information, see [Recovering using HP Recovery media on page 58](#).

For more information about the first two methods, see the Get Help app:

- Select the **Start** button, select **All apps**, select the **Get Help** app, and then enter the task you want to perform.



---

**NOTE:** You must be connected to the internet to access the Get Help app.

---

## Recovering using HP Recovery media

You can use HP Recovery media to recover the original operating system and software programs that were installed at the factory. On select products, it can be created on a bootable USB flash drive using the HP Cloud Recovery Download Tool.

For details, see [Using the HP Cloud Recovery Download Tool to create recovery media \(select products only\) on page 57](#).



---

**NOTE:** If you cannot create recovery media yourself, contact support to obtain recovery discs. Go to <http://www.hp.com/support>, select your country or region, and then follow the on-screen instructions.

---

To recover your system:

- Insert the HP Recovery media, and then restart the computer.



---

**NOTE:** HP recommends that you follow the [Restoring and recovery methods on page 58](#) to restore your computer before you obtain and use the HP recovery discs. Using a recent backup can return your machine to a working state sooner than using the HP recovery discs. After the system is restored, reinstalling all the operating system software released since your initial purchase can be a lengthy process.

---

## Changing the computer boot order

If your computer does not restart using the HP Recovery media, you can change the computer boot order, the order of devices listed in BIOS for startup information. You can select an optical drive or a USB flash drive, depending on the location of your HP Recovery media.

---

 **IMPORTANT:** For a tablet with a detachable keyboard, connect the tablet to the keyboard base before beginning these steps.

---

To change the boot order:

1. Insert the HP Recovery media.
2. Access the system **Startup** menu.
  - For computers or tablets with keyboards attached, turn on or restart the computer or tablet, quickly press **esc**, and then press **f9** for boot options.
  - For tablets without keyboards, turn on or restart the tablet, quickly press and hold the volume up button, and then select **f9**.

– or –

Turn on or restart the tablet, quickly press and hold the volume down button, and then select **f9**.
3. Select the optical drive or USB flash drive from which you want to boot, and then follow the on-screen instructions.

## Using HP Sure Recover (select products only)

Select computer models are configured with HP Sure Recover, a PC operating system (OS) recovery solution built into the hardware and software. HP Sure Recover can fully restore the HP OS image without installed recovery software.

Using HP Sure Recover, an administrator or user can restore the system and install:

- Latest version of the operating system
- Platform-specific device drivers
- Software applications, in the case of a custom image

To access the latest documentation for HP Sure Recover, go to <http://www.hp.com/support>. Follow the on-screen instructions to find your product and locate your documentation.



---

# 12 Electrostatic discharge

Electrostatic discharge is the release of static electricity when two objects come into contact—for example, the shock you receive when you walk across the carpet and touch a metal door knob.

A discharge of static electricity from fingers or other electrostatic conductors may damage electronic components.

---

 **IMPORTANT:** To prevent damage to the computer, damage to a drive, or loss of information, observe these precautions:

- If removal or installation instructions direct you to unplug the computer, first be sure that it is properly grounded.
  - Keep components in their electrostatic-safe containers until you are ready to install them.
  - Avoid touching pins, leads, and circuitry. Handle electronic components as little as possible.
  - Use nonmagnetic tools.
  - Before handling components, discharge static electricity by touching an unpainted metal surface.
  - If you remove a component, place it in an electrostatic-safe container.
-

---

# 13 Specifications

When you travel with or store your computer, the input power ratings and operating specifications provide helpful information.

## Input power

The power information in this section might be helpful if you plan to travel internationally with the computer.

The computer operates on DC power, which can be supplied by an AC or a DC power source. The AC power source must be rated at 100 V–240 V, 50 Hz–60 Hz. Although the computer can be powered from a standalone DC power source, it should be powered only with an AC adapter or a DC power source supplied and approved by HP for use with this computer.

The computer can operate on DC power within one or more of the following specifications. The voltage and current for your computer is located on the regulatory label.

**Table 13-1 DC power specifications**

Input Power	Rating
Operating voltage and current	5 V dc @ 3 A / 9 V dc @ 3 A / 12 V dc @ 2.5 A / 15 V dc @ 2 A – 30 W USB-C®
	5 V dc @ 2 A / 12 V dc @ 3 A / 15 V dc @ 3 A – 45 W USB-C
	5 V dc @ 3 A / 9 V dc @ 3 A / 12 V dc @ 3.75 A / 15 V dc @ 3 A – 45 W USB-C
	5 V dc @ 3 A / 9 V dc @ 3 A / 10 V dc @ 3.75 A / 12 V dc @ 3.75 A / 15 V dc @ 3 A / 20 V dc @ 2.25 A – 45 W USB-C
	5 V dc @ 3 A / 9 V dc @ 3 A / 12 V dc @ 5 A / 15 V dc @ 4.33 A / 20 V dc @ 3.25 A – 65 W USB-C
	5 V dc @ 3 A / 9 V dc @ 3 A / 10 V dc @ 5 A / 12 V dc @ 5 A / 15 V dc @ 4.33 A / 20 V dc @ 3.25 A – 65 W USB-C
	5 V dc @ 3 A / 9 V dc @ 3 A / 10 V dc @ 5 A / 12 V dc @ 5 A / 15 V dc @ 5 A / 20 V dc @ 4.5 A – 90 W USB-C
	5 V dc @ 3 A / 9 V dc @ 3 A / 12 V dc @ 5 A / 15 V dc @ 5 A / 20 V dc @ 5 A / 5 V dc USB-A port @ 2 A – 100 W USB-C + 10 W USB-A
	19.5 V dc @ 2.31 A – 45 W
	19.5 V dc @ 3.33 A – 65 W
	19.5 V dc @ 4.62 A – 90 W
	19.5 V dc @ 6.15 A – 120 W
	19.5 V dc @ 6.9 A – 135 W
	19.5 V dc @ 7.70 A – 150 W
19.5 V dc @ 10.3 A – 200 W	
19.5 V dc @ 11.8 A – 230 W	
19.5 V dc @ 16.92 A – 330 W	
20 V dc @ 14 A – 280 W	



**NOTE:** This product is designed for IT power systems in Norway with phase-to-phase voltage not exceeding 240 V rms.

## Operating environment

Use the operating specifications for helpful information when you travel with or store your computer.

**Table 13-2 Operating environment specifications**

Factor	Metric	U.S.
<b>Temperature</b>		
Operating	5°C to 35°C	41°F to 95°F
Nonoperating	–20°C to 60°C	–4°F to 140°F

**Table 13-2 Operating environment specifications (continued)**

<b>Factor</b>	<b>Metric</b>	<b>U.S.</b>
<b>Relative humidity (noncondensing)</b>		
Operating	<b>10% to 90%</b>	10% to 90%
Nonoperating	<b>5% to 95%</b>	5% to 95%
<b>Maximum altitude (unpressurized)</b>		
Operating	<b>-15 m to 3,048 m</b>	-50 ft to 10,000 ft
Nonoperating	<b>-15 m to 12,192 m</b>	-50 ft to 40,000 ft

---

# 14 Accessibility

HP's goal is to design, produce, and market products, services, and information that everyone everywhere can use, either on a stand-alone basis or with appropriate third-party assistive technology (AT) devices or applications.

## HP and accessibility

Because HP works to weave diversity, inclusion, and work/life into the fabric of the company, it is reflected in everything HP does. HP strives to create an inclusive environment focused on connecting people to the power of technology throughout the world.

## Finding the technology tools you need

Technology can unleash your human potential. Assistive technology removes barriers and helps you create independence at home, at work, and in the community. Assistive technology helps increase, maintain, and improve the functional capabilities of electronic and information technology.

For more information, see [Finding the best assistive technology on page 65](#).

## The HP commitment

HP is committed to providing products and services that are accessible for people with disabilities. This commitment supports the company's diversity objectives and helps ensure that the benefits of technology are available to all.

The HP accessibility goal is to design, produce, and market products and services that can be effectively used by everyone, including people with disabilities, either on a stand-alone basis or with appropriate assistive devices.

To achieve that goal, this Accessibility Policy establishes seven key objectives to guide HP actions. All HP managers and employees are expected to support these objectives and their implementation in accordance with their roles and responsibilities:

- Raise the level of awareness of accessibility issues within HP, and provide employees with the training they need to design, produce, market, and deliver accessible products and services.
- Develop accessibility guidelines for products and services, and hold product development groups accountable for implementing these guidelines where competitively, technically, and economically feasible.
- Involve people with disabilities in the development of accessibility guidelines and in the design and testing of products and services.
- Document accessibility features, and make information about HP products and services publicly available in an accessible form.
- Establish relationships with leading assistive technology and solution providers.
- Support internal and external research and development that improves assistive technology relevant to HP products and services.
- Support and contribute to industry standards and guidelines for accessibility.

## International Association of Accessibility Professionals (IAAP)

IAAP is a not-for-profit association focused on advancing the accessibility profession through networking, education, and certification. The objective is to help accessibility professionals develop and advance their careers and to better enable organizations to integrate accessibility into their products and infrastructure.

As a founding member, HP joined to participate with other organizations to advance the field of accessibility. This commitment supports HP's accessibility goal of designing, producing, and marketing products and services that people with disabilities can effectively use.

IAAP will make the profession strong by globally connecting individuals, students, and organizations to learn from one another. If you are interested in learning more, go to <http://www.accessibilityassociation.org> to join the online community, sign up for newsletters, and learn about membership options.

## Finding the best assistive technology

Everyone, including people with disabilities or age-related limitations, should be able to communicate, express themselves, and connect with the world using technology. HP is committed to increasing accessibility awareness within HP and with our customers and partners.

Whether it's large fonts that are easy on the eyes, voice recognition that lets you give your hands a rest, or any other assistive technology to help with your specific situation—a variety of assistive technologies make HP products easier to use. How do you choose?

## Assessing your needs

Technology can unleash your potential. Assistive technology removes barriers and helps you create independence at home, at work, and in the community. Assistive technology (AT) helps increase, maintain, and improve the functional capabilities of electronic and information technology.

You can choose from many AT products. Your AT assessment should allow you to evaluate several products, answer your questions, and facilitate your selection of the best solution for your situation. You will find that professionals qualified to do AT assessments come from many fields, including those licensed or certified in physical therapy, occupational therapy, speech/language pathology, and other areas of expertise. Others, while not certified or licensed, can also provide evaluation information. You will want to ask about the individual's experience, expertise, and fees to determine if they are appropriate for your needs.

## Accessibility for HP products

These links provide information about accessibility features and assistive technology, if applicable and available in your country or region, that are included in various HP products. These resources will help you select the specific assistive technology features and products most appropriate for your situation.

- **HP Aging & Accessibility:** Go to <http://www.hp.com>, type **Accessibility** in the search box. Select **Office of Aging and Accessibility**.
- **HP computers:** For Windows products, go to <http://www.hp.com/support>, type **Windows Accessibility Options** in the **Search our knowledge** search box. Select the appropriate operating system in the results.
- **HP Shopping, peripherals for HP products:** Go to <http://store.hp.com>, select **Shop**, and then select **Monitors** or **Accessories**.

If you need additional support with the accessibility features on your HP product, see [Contacting support on page 68](#).

Additional links to external partners and suppliers that may provide additional assistance:

- [Microsoft Accessibility information \(Windows and Microsoft Office\)](#)
- [Google Products accessibility information \(Android, Chrome, Google Apps\)](#)

## Standards and legislation

Countries worldwide are enacting regulations to improve access to products and services for persons with disabilities. These regulations are historically applicable to telecommunications products and services, PCs and printers with certain communications and video playback features, their associated user documentation, and their customer support.

### Standards

The US Access Board created Section 508 of the Federal Acquisition Regulation (FAR) standards to address access to information and communication technology (ICT) for people with physical, sensory, or cognitive disabilities.

The standards contain technical criteria specific to various types of technologies, as well as performance-based requirements which focus on functional capabilities of covered products. Specific criteria cover software applications and operating systems, web-based information and applications, computers, telecommunications products, video and multimedia, and self-contained closed products.

### Mandate 376 – EN 301 549

The European Union created the EN 301 549 standard within Mandate 376 as an online toolkit for public procurement of ICT products. The standard specifies the accessibility requirements applicable to ICT products and services, with a description of the test procedures and evaluation methodology for each requirement.

### Web Content Accessibility Guidelines (WCAG)

Web Content Accessibility Guidelines (WCAG) from the W3C's Web Accessibility Initiative (WAI) helps web designers and developers create sites that better meet the needs of people with disabilities or age-related limitations.

WCAG advances accessibility across the full range of web content (text, images, audio, and video) and web applications. WCAG can be precisely tested, is easy to understand and use, and allows web developers flexibility for innovation. WCAG 2.0 has also been approved as [ISO/IEC 40500:2012](#).

WCAG specifically addresses barriers to accessing the web experienced by people with visual, auditory, physical, cognitive, and neurological disabilities, and by older web users with accessibility needs. WCAG 2.0 provides characteristics of accessible content:

- **Perceivable** (for instance, by addressing text alternatives for images, captions for audio, adaptability of presentation, and color contrast)
- **Operable** (by addressing keyboard access, color contrast, timing of input, seizure avoidance, and navigability)
- **Understandable** (by addressing readability, predictability, and input assistance)
- **Robust** (for instance, by addressing compatibility with assistive technologies)

### Legislation and regulations

Accessibility of IT and information has become an area of increasing legislative importance. These links provide information about key legislation, regulations, and standards.

- [United States](#)
- [Canada](#)
- [Europe](#)
- [Australia](#)

## Useful accessibility resources and links

These organizations, institutions, and resources might be good sources of information about disabilities and age-related limitations.



**NOTE:** This is not an exhaustive list. These organizations are provided for informational purposes only. HP assumes no responsibility for information or contacts you encounter on the internet. Listing on this page does not imply endorsement by HP.

---

### Organizations

These organizations are a few of the many that provide information about disabilities and age-related limitations.

- American Association of People with Disabilities (AAPD)
- The Association of Assistive Technology Act Programs (ATAP)
- Hearing Loss Association of America (HLAA)
- Information Technology Technical Assistance and Training Center (ITTATC)
- Lighthouse International
- National Association of the Deaf
- National Federation of the Blind
- Rehabilitation Engineering & Assistive Technology Society of North America (RESNA)
- Telecommunications for the Deaf and Hard of Hearing, Inc. (TDI)
- W3C Web Accessibility Initiative (WAI)

### Educational institutions

Many educational institutions, including these examples, provide information about disabilities and age-related limitations.

- California State University, Northridge, Center on Disabilities (CSUN)
- University of Wisconsin - Madison, Trace Center
- University of Minnesota computer accommodations program

### Other disability resources

Many resources, including these examples, provide information about disabilities and age-related limitations.

- ADA (Americans with Disabilities Act) Technical Assistance Program



- ILO Global Business and Disability network
- EnableMart
- European Disability Forum
- Job Accommodation Network
- Microsoft Enable

## HP links

These HP-specific links provide information that relates to disabilities and age-related limitations.

[HP comfort and safety guide](#)

[HP public sector sales](#)

## Contacting support

HP offers technical support and assistance with accessibility options for customers with disabilities.



---

**NOTE:** Support is in English only.

---

- Customers who are deaf or hard of hearing who have questions about technical support or accessibility of HP products:
  - Use TRS/VRS/WebCapTel to call (877) 656-7058 Monday through Friday, 6 a.m. to 9 p.m. Mountain Time.
- Customers with other disabilities or age-related limitations who have questions about technical support or accessibility of HP products:
  - Call (888) 259-5707 Monday through Friday, 6 a.m. to 9 p.m. Mountain Time.

# Index

## A

- AC adapter and battery light, identifying 4
- accessibility 64–66, 68
- accessibility needs assessment 65
- action key, identifying 11
- action keys
  - decrease screen brightness 13
  - help 12
  - HP Hubs Launcher app 13
  - identifying 12
  - increase screen brightness 13
  - keyboard backlight 13
  - mute microphone 13
  - mute volume 13
  - next track 13
  - pause 13
  - play 13
  - previous track 13
  - privacy screen 13
  - speaker volume 13
  - using 12
  - volume
    - mute 13
- airplane mode 19
- airplane mode key 19
- ambient light and color sensor, identifying 6
- antivirus software, using 45
- assistive technology (AT)
  - finding 65
  - purpose 64
- AT (assistive technology)
  - finding 65
  - purpose 64
- audio 23
  - adjusting volume 13
  - headphones 23
  - headsets 24
  - sound settings 24
  - speakers 23
- audio-out (headphone)/audio-in (microphone) combo jack, identifying 5

## B

- backing up software and information 46
- backup, creating 57
- backups 57
- battery
  - conserving power 34
  - discharging 34
  - factory-sealed 35
  - finding information 34
  - low battery levels 34
  - resolving low battery level 35
- battery charge 34
- battery information, finding 34
- battery power 33
- best practices 1
- BIOS
  - determining version 48
  - downloading an update 49
  - starting the Setup Utility 48
  - updating 48
- Bluetooth device 19, 21
- Bluetooth label 15
- boot order, changing 59
- bottom components 14
- buttons
  - left touchpad 7, 8
  - power 10, 12
  - right touchpad 7, 8

## C

- camera
  - identifying 6
  - using 23
- camera light, identifying 6
- camera privacy key, identifying 12
- camera privacy key, using 23
- camera privacy light, identifying 9
- caps lock light 9
- caring for your computer 39
- cleaning your computer 39
  - caring for wood veneer 41
  - disinfecting 40
  - HP Easy Clean 39
  - removing dirt and debris 39
- components
  - bottom 14

- display 5
- keyboard area 7
- left side 4
- lights 8
- rear 14
- right side 3
- touchpad 7
- connecting to a network 19
- connecting to a wireless network 19
- connecting to a WLAN 19
- connecting to LAN 22
- connectors
  - power 4
- control zone 7
- corporate WLAN connection 19
- critical battery level 34
- customer support, accessibility 68

## D

- data transfer 26
- decrease screen brightness action key 13
- Disk Cleanup software 37
- Disk Defragmenter software 37
- display components 5
- display states 25

## E

- electrostatic discharge 60
- esc key, identifying 11
- eSIM 21
- external power, using 35

## F

- factory-sealed battery 35
- fingerprint reader 11
- fingerprints, registering 45
- firewall software 45
- fn key, identifying 11
- four-finger swipe touchpad
  - gesture 29
- four-finger tap touchpad
  - gesture 29

## G

- gestures 27

Get Help in Windows action key 12  
GPS 21

## H

hardware, locating 3  
headphones, connecting 23  
headsets, connecting 24  
Hibernation  
    exiting 32  
    initiated during critical battery level 34  
    initiating 32  
high-definition devices, connecting 26  
HP 3D DriveGuard 37  
HP Assistive Policy 64  
HP Fast Charge 33  
HP Hubs Launcher app key, identifying 13, 14  
HP Mobile Broadband  
    activating 20  
    IMEI number 20  
    MEID number 20  
HP PC Hardware Diagnostics UEFI  
    downloading 54  
    failure ID code 53  
    starting 53  
    using 53  
HP PC Hardware Diagnostics Windows  
    accessing 51, 52  
    downloading 52  
    failure ID code 51  
    installing 53  
    using 51  
HP Recovery media  
    recovery 58  
HP resources 1  
HP Sure Recover 59  
HP TechPulse 46

## I

IMEI number 20  
increase screen brightness action key 13  
initiating Sleep and Hibernation 31  
input power 61  
installing  
    optional security cable 47  
internal microphones, identifying 6  
International Association of Accessibility Professionals 65  
internet security software, using 45

## J

jacks  
    audio-out (headphone)/audio-in (microphone) 5

## K

keyboard and optional mouse using 30  
keyboard backlight action key 13  
keys  
    action 11  
    camera privacy 12  
    esc 11  
    fn 11  
    Windows 11

## L

labels  
    Bluetooth 15  
    regulatory 15  
    serial number 15  
    service 15  
    wireless certification 15  
    WLAN 15  
left control zone, identifying 7  
left side components 4  
lights  
    AC adapter and battery 4  
    camera 6  
    camera privacy 9  
    caps lock 9  
    microphone mute 9  
    mute 9  
    power 9  
    touchpad 7  
low battery level 34  
low blue light mode 5

## M

maintenance  
    Disk Cleanup 37  
    Disk Defragmenter 37  
    updating programs and drivers 38  
managing power 31  
MEID number 20  
microphone mute light, identifying 9  
Miracast 26  
mobile broadband  
    activating 20  
    IMEI number 20  
    MEID number 20

mute light, identifying 9  
mute microphone action key 13  
mute volume action key 13

## N

nano SIM card, inserting 17  
nano SIM slot, identifying 5  
navigating the screen 27  
next track action key 13

## O

on-screen keyboard 30  
one-finger slide touch screen gesture 30  
operating environment 62  
operating system controls 19

## P

passwords  
    Setup Utility (BIOS) 44  
    Windows 43  
pause action key 13  
play action key 13  
ports  
    USB SuperSpeed port with HP Sleep and Charge 5  
    USB Type-C 26  
    USB Type-C power connector and Thunderbolt port with HP Sleep and Charge and DisplayPort output 4  
    USB Type-C Thunderbolt 25  
power  
    battery 33  
    external 35  
power button, identifying 10, 12  
power connector  
    identifying 4  
Power icon, using 33  
power light, identifying 9  
power settings, using 33  
precision touchpad  
    using 27  
precision touchpad gestures  
    four-finger swipe 29  
    four-finger tap 29  
    three-finger swipe 29  
    three-finger tap 28  
    two-finger slide 28  
    two-finger tap 28  
previous track action key 13  
privacy screen action key 13

- product name and number,
  - computer 15
- public WLAN connection 19
- R**
- rear components 14
- recovery 57
  - discs 58
  - media 58
  - USB flash drive 58
- recovery media 57
  - creating using HP Cloud Recovery Download Tool 57
  - creating using Windows tools 57
- regulatory information
  - regulatory label 15
  - wireless certification labels 15
- Remote HP PC Hardware Diagnostics
  - UEFI settings
    - customizing 55
    - using 55
- resources, accessibility 67
- restoring 57
- restoring and recovery methods 58
- right control zone, identifying 7
- right side components 3
- S**
- screen
  - navigating 27
- Section 508 accessibility
  - standards 66
- security cable, installing 47
- serial number, computer 15
- service labels, locating 15
- Setup Utility (BIOS) passwords 44
- shipping the computer 41
- shutdown 32
- SIM card, correct size 17
- SIM card, inserting 17
- SIM slot, identifying 3
- Sleep
  - exiting 31
  - initiating 31
- Sleep and Hibernation,
  - initiating 31
- slots
  - nano SIM card 5
  - SIM card 3
- software
  - Disk Cleanup 37
  - Disk Defragmenter 37
  - locating 3
- software installed
  - locating 3
- software updates, installing 46
- sound
  - See audio
- sound settings, using 24
- speaker volume action keys 13
- speakers 15
  - connecting 23
- special keys
  - identifying 11
  - using 11
- specifications 61
- standards and legislation,
  - accessibility 66
- system restore 58
- system restore point, creating 57
- T**
- tap touchpad and touch screen
  - gesture 27
- three-finger swipe touchpad
  - gesture 29
- three-finger tap touchpad
  - gesture 28
- Thunderbolt, connecting USB Type-C 25
- touch screen gestures
  - one-finger slide 30
  - slide 30
  - tap 27
  - two-finger pinch zoom 27
- touchpad
  - settings 7
  - using 27
- touchpad and touch screen gestures
  - tap 27
  - two-finger pinch zoom 27
- touchpad buttons
  - identifying 7, 8
- touchpad components 7
- touchpad gestures
  - four-finger swipe 29
  - four-finger tap 29
  - three-finger swipe 29
  - three-finger tap 28
  - two-finger slide 28
  - two-finger tap 28
- touchpad light, identifying 7
- touchpad settings, adjusting 7
- touchpad zone, identifying 7, 8
- transfer data 26
- traveling with the computer 15, 41
- turning off the computer 32
- two-finger pinch zoom touchpad and
  - touch screen gesture 27
- two-finger slide touchpad
  - gesture 28
- two-finger tap touchpad
  - gesture 28
- U**
- unresponsive system 32
- updating drivers 38
- updating programs 38
- updating programs and drivers 38
- USB SuperSpeed port with HP Sleep and Charge, identifying 5
- USB Type-C port, connecting 25, 26
- USB Type-C power connector and
  - Thunderbolt port with HP Sleep and Charge and DisplayPort output, identifying 4
  - using passwords 43
  - using the keyboard and optional mouse 30
  - using the touchpad 27
- V**
- vents, identifying 14, 15
- video
  - Thunderbolt port device 25
  - USB Type-C 26
  - wireless displays 26
- video, using 24
- volume
  - adjusting 13
- W**
- wake-on-touch 5
- Windows
  - backup 57
  - recovery media 57
  - system restore point 57
- Windows Hello 23
  - using 45
- Windows key, identifying 11
- Windows passwords 43
- Windows tools, using 57
- wired network (LAN) 22
- wireless antennas, identifying 6
- wireless button 19
- wireless certification label 15
- wireless controls
  - button 19
  - operating system 19

- wireless light 19
- wireless network (WLAN)
  - connecting 19
  - corporate WLAN connection 19
  - functional range 19
  - public WLAN connection 19
- wireless network, securing 46
- WLAN antennas, identifying 6
- WLAN device 15
- WLAN label 15
- WWAN antennas, identifying 6
- WWAN device 20