



Mixels™

WUZZO



41547



6126511

1

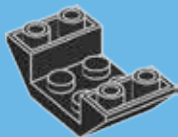

2



3

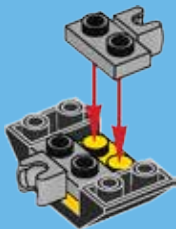

4

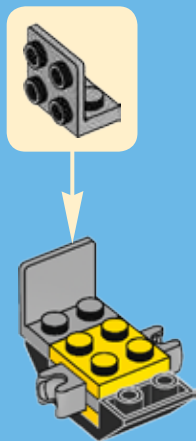

5

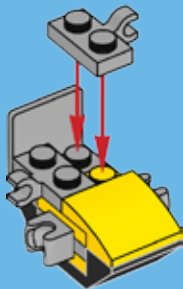

6

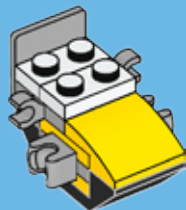



7



8



9

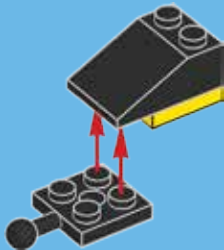

10

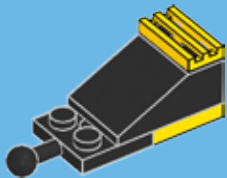

11

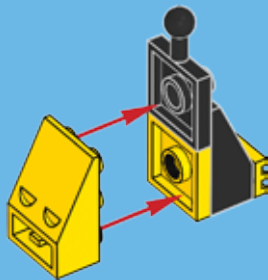

12



2x

13

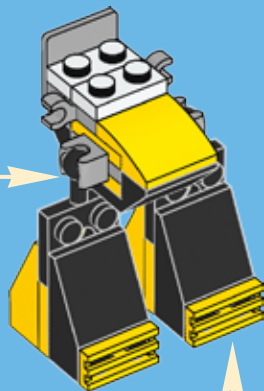

1



2



2x

14

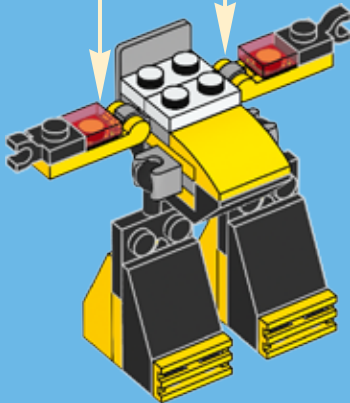

15

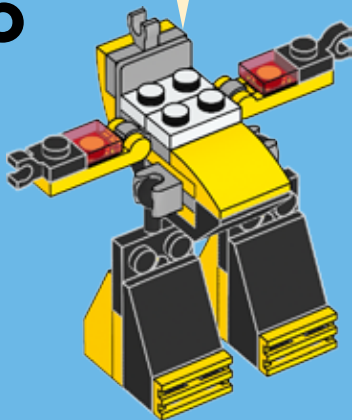



16

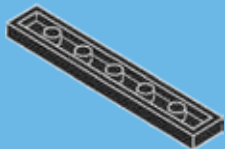

17

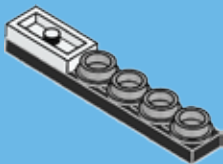

18

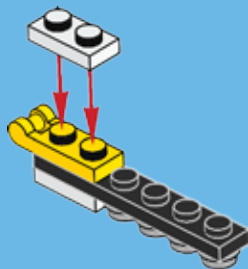

19

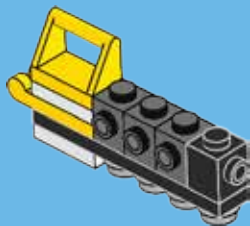

20

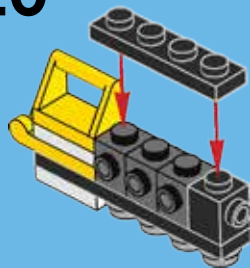

21

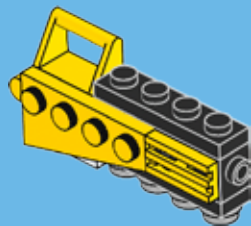

22

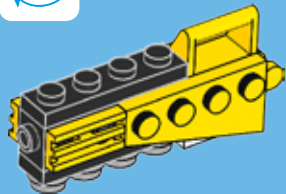

23

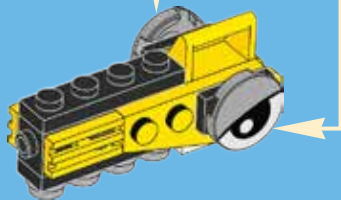

24

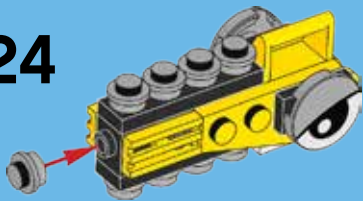

25

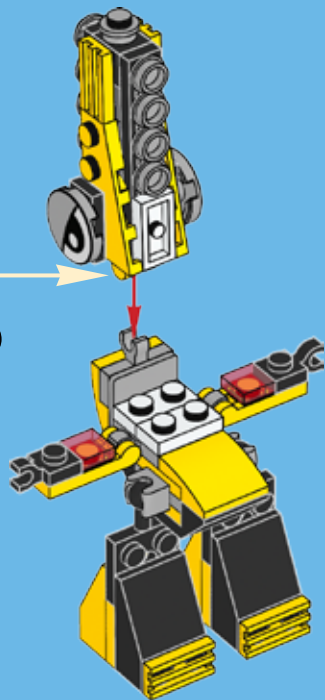



26



27

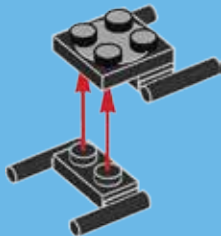

28

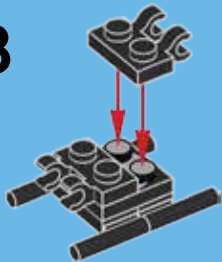

29



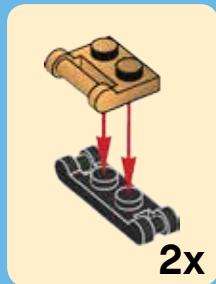

30

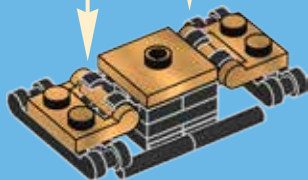



31

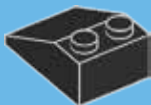

32

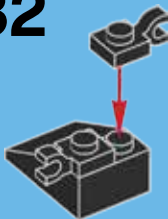

33

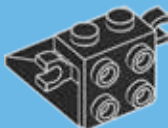

34

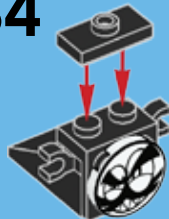

35

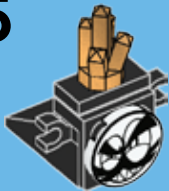

36

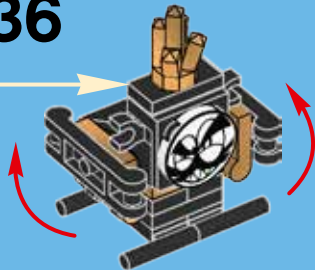



1x
4558954



4x
4517925



3x
6092585



2x
4556158



2x
6051038



1x
6117973



2x
383926



1x
368026



2x
6099483



1x
371026

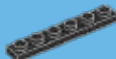

1x
366626



1x
4188534



3x
329826



1x
243224



3x
4515367



2x
6079007



2x
374724



1x
4161331



1x
4160868



4x
241224



4x
302224



2x
6043656



3x
6028812



1x
4654580



9x
4211525



3x
4213574



4x
302301



1x
6097124



2x
6100970



1x
4540203



2x
3003941



1x
6107193



2x
4585493



1x
4516816



Customer Service

Kundenservice

Service Consommateurs

Servicio Al Consumidor

LEGO.com/service or dial



: 00800 5346 5555



: 1-800-422-5346



LEGO.com/mixels





**KRAMM
41545**



**FORX
41546**



**WUZZO
41547**



WELDOS MAX!



LEGO.com/mixels





Mixels™

SERIES
6



41545
KRAMM



41546
FORX



41547
WUZZO



41548
DRIBBAL



41549
GURGGLE



41550
SLUSHO



41551
SNAX



41552
BERP



41553
VAKA-WAKA



LEGO.com/mixels



Mixels RUSH



**YOU CAN
BUY THE
GAME!**

CH A 1 N S A 8

IN GAME CODE!



Apple, the Apple logo, iPad, iPhone and iPod touch are trademarks of Apple Inc., registered in the U.S. and other countries. App Store is a service mark of Apple Inc. Google Play is a trademark of Google Inc.

WIN

GO TO WWW.LEGO.COM/PRODUCTFEEDBACK AND
GIVE US YOUR SHORT **FEEDBACK** ABOUT THIS
LEGO® SET FOR A CHANCE TO WIN
A COOL LEGO PRIZE.



LEGO.com/productfeedback

GEWINNE



Erzähle uns auf
www.LEGO.com/productfeedback

etwas über die Erfahrungen, die
du mit diesem LEGO® Set gemacht
hast, und sichere dir die Chance auf
einen coolen LEGO Preis!

GAGNE



Rends-toi sur
www.LEGO.com/productfeedback

et donne-nous quelques commen-
taires sur ce produit LEGO® pour
avoir une chance de gagner un
prix LEGO !

GANA



Visita
www.LEGO.com/productfeedback

y envíanos tu opinión acerca de este
set LEGO®. ¡Participarás en el sorteo
de un premio LEGO!

获取奖品



登录
www.LEGO.com/productfeedback

给出关于此乐高®套装的简短反馈，
就有机会获得炫酷乐高奖品

LEGO, the LEGO logo and MIXELS are trademarks and/or copyrights of the LEGO Group.
©2015 The LEGO Group. All rights reserved.
TM & © 2015 Cartoon Network

6126511